



CRAFTED FOR YOUR SURGICAL SUCCESS



a Legacy of Excellence

*Welcome to Care Medical Supplies
Since our founding in 1972, we have
been committed to the noble cause of
serving humanity by providing
top-notch surgical instruments. Our
Journey, rooted in integrity and
innovation, has been dedicated to
improving healthcare worldwide.*

***Care Medical Supplies to the
World, which is only possible if
we abide by all the regional
regulations and we do. Care
Medical Supplies is proudly
certified by FDA, ISO 9001, ISO
13485, CE, FDA, and SCCI. Care
Medical is already en route to
being certified with EU-MDR
continuing our commitment to
the European market.***

Precision Instruments Life-saving Results



Brochure Series
2025/26

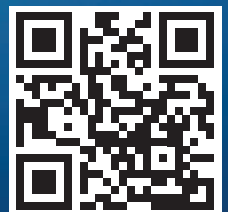

View our Catalogues



Your reliable
Companion for
unmatched
perfection

JOURNEY TO SUPERIOR

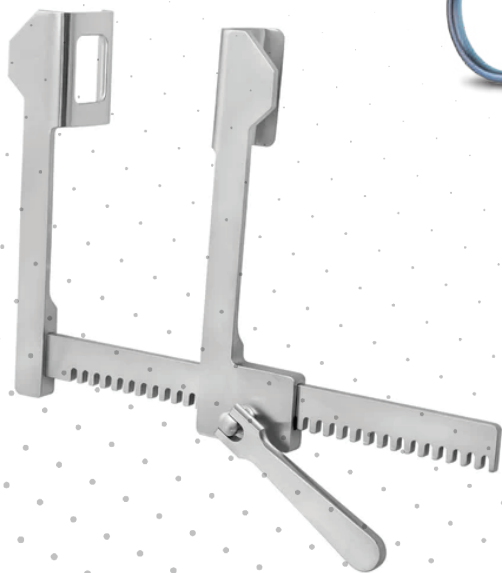

RIB SHEARS

Allowing surgeons to access the thoracic cavity or perform procedures involving the ribs. Rib shears typically have a curved blade that enables controlled and accurate cutting.

They help in creating an opening in the chest wall by cutting through the ribs while minimizing trauma to surrounding tissues.

TURNER WARWICK UROLOGICAL RETRACTOR COMPLETE SET

Turner-Warwick Urological Retractor is a specialized surgical instrument commonly used in delicate surgeries to achieve 360-degree exposure for manipulation. Frequently used in urological procedures as well as general surgeries.

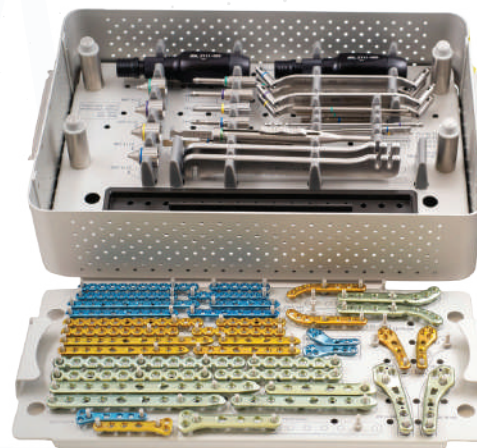
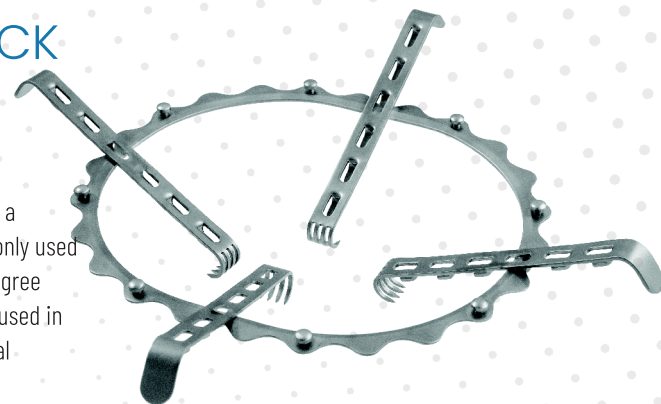

ARIX VETERINARY IMPLANTS

BENEFITS

- Various plate shapes and sizes for Cats and dogs from small to large
- Variable locking system
- Anatomically pre-contoured
- Left & right plate variation for anatomical fitting
- Limited contact design for better blood supply

CASPAR SYSTEM COMPLETE SET W/Instrmt Tray

Optional additional blades can be purchased as a set. To purchase individual blades please add to cart separately.



TRUST IN THE
BEST FOR

FLAWLESS PERFORMANCE

Explore the Premium Range of
Surgical Instruments

MICTEC DEBAKEY FORCEPS FENESTRATED

Our instruments are premium products made in Tuttlingen, Germany.



THORACIC SUCTION HANDLE ANGLED

Suction Tube is designed to remove fluids and debris from the surgical site. Handle for a comfortable and secure grip. Surgical grade and reusable to provide the highest level of craftsmanship



WIRE PIN CUTTERS

Specifically designed to cut and shape bones during orthopaedic procedures.

VASECTOMY DISSECTION FORCEPS SHARP

Our instruments are premium products made in Tuttlingen, Germany.



MICRO DEBAKEY FORCEPS

Micro Forceps are designed to give the same feel and balance as our standard line of forceps.



MICRO NEEDLE HOLDERS TITANIUM

Micro needle holders made by a high quality titanium alloy made with the same dedication to details as our stainless steel micro.



SCISSORS

Care Medical Supplies is renowned for our unique, light and well-balanced surgical scissors. Care Medical scissors confer maximum cutting strength in all types of soft tissue with minimal force, not just when new, but after many years of use.

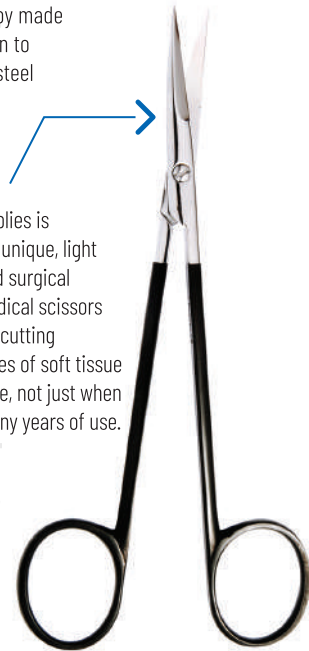

CHISELS

In the realm of orthopedic surgery, reliability is paramount. Our Chisels and Osteotomes are meticulously crafted to meet these rigorous standards. These instruments are expertly designed.



BULLDOG CLAMPS

Bulldog clamps, also known as vascular clamps or simply bulldogs, are surgical instruments used to temporarily occlude blood vessels during various medical procedures. These clamps are designed to grasp and seal off blood vessels, allowing surgeons to control blood flow in a precise and temporary manner.

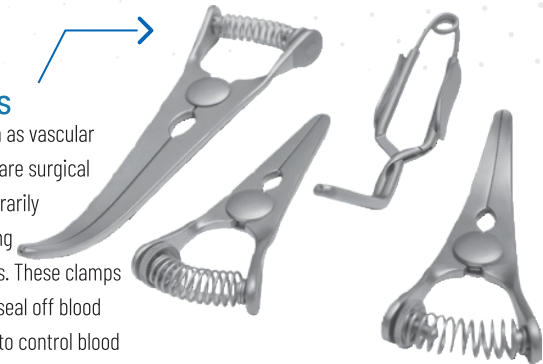

**QUALITY &
PRECISION**

IN EVERY CRAFTED INSTRUMENT



**Crafted for Clarity
designed for excellence**

These Hartmann Forceps are used in ear surgical procedures, particularly stapedectomies.

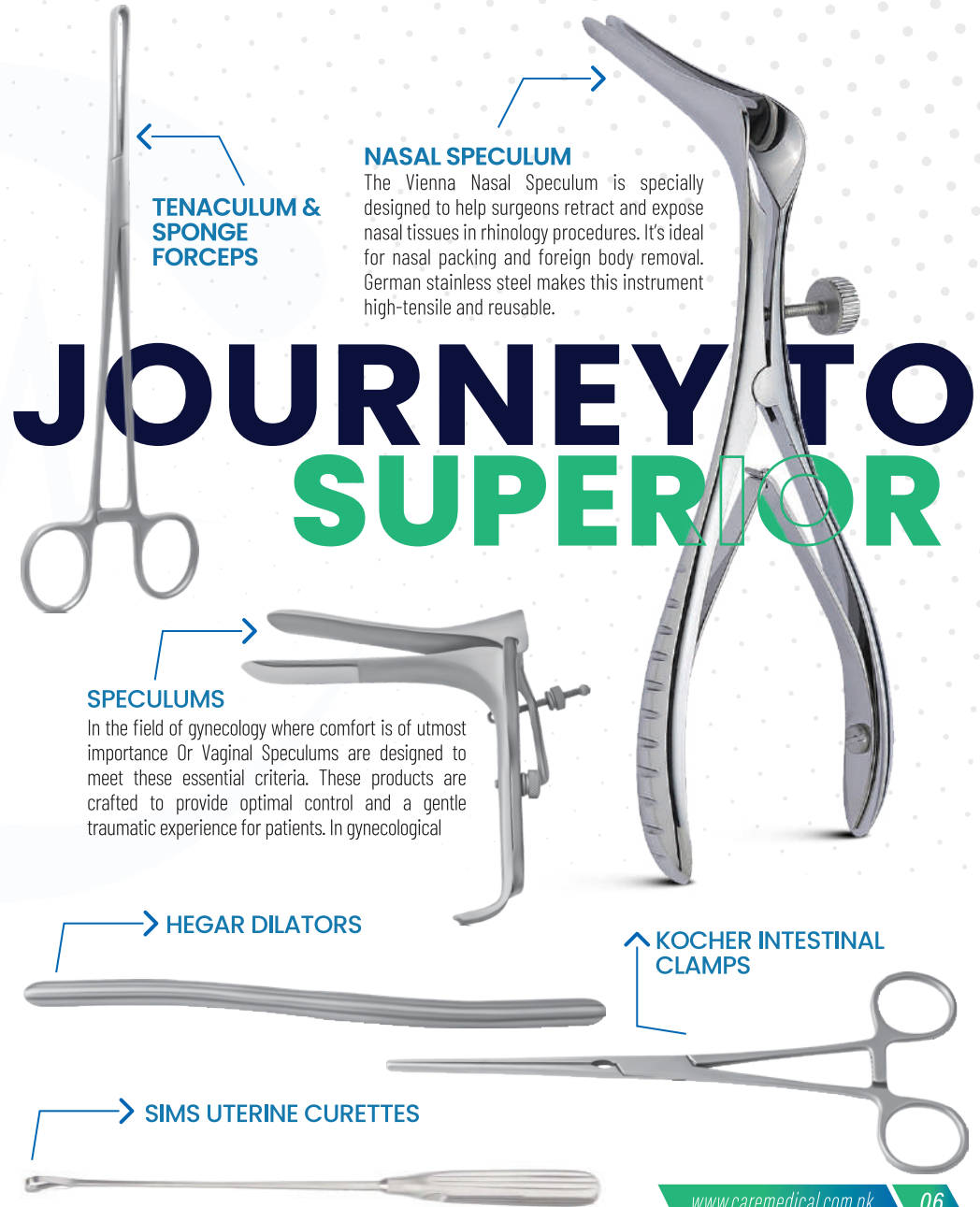

**TENACULUM &
SPONGE
FORCEPS**

NASAL SPECULUM

The Vienna Nasal Speculum is specially designed to help surgeons retract and expose nasal tissues in rhinology procedures. It's ideal for nasal packing and foreign body removal. German stainless steel makes this instrument high-tensile and reusable.

JOURNEY TO SUPERIOR

SPECULUMS

In the field of gynecology where comfort is of utmost importance Or Vaginal Speculums are designed to meet these essential criteria. These products are crafted to provide optimal control and a gentle traumatic experience for patients. In gynecological

HEGAR DILATORS

**KOCHER INTESTINAL
CLAMPS**

SIMS UTERINE CURETTES

UPPER ROOT EXTRACTOR FORCEPS

The jaws have a unique curved angle that can effectively grip molars while distributing pressure evenly, minimizing trauma to surrounding tissues.



BLUMENTHAL RONGEUR 45° ANGLE

Dental Rongeurs Blumenthal 4.5" (11.4cm) 45 Degree Angled Tips Oral Surgery Dentist Plier O.R Grade Stainless Steel Surgical Dental Instruments



EXPLORERS



ORTHODONTIC PLIERS



BREWER TYPE RUBBER DAM FORCEPS



ELEVATORS

Dental elevators are considered to be among the best elevators due to their precision and durability. They are made from premium materials and are designed to provide excellent control and leverage during tooth extraction procedures.



WEITLANER MOUTH SPREADER FENESTRATED

Weitlaner Retractor Solid Blades are medical-grade instruments manufactured to retract tougher tissues during orthopedic procedures.

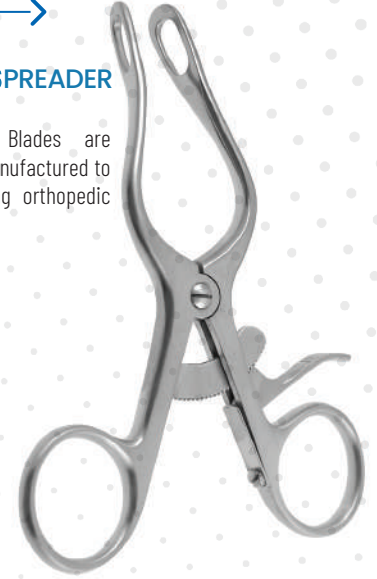

RUBBER DAM CLAMPS



IMPLANT KIT



DEBONDING & DEBANDING SET

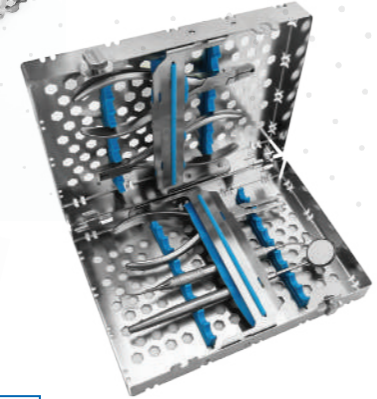

DENTAL KIT



Comforting EXCELLENCE



TOWEL CLAMPS

Towel clamps, also known as surgical towel forceps or backhaus clamps, are essential tools in surgical settings used to secure surgical drapes and towels to maintain a sterile field during procedures.

NEEDLE HOLDERS



TISSUE FORCEPS

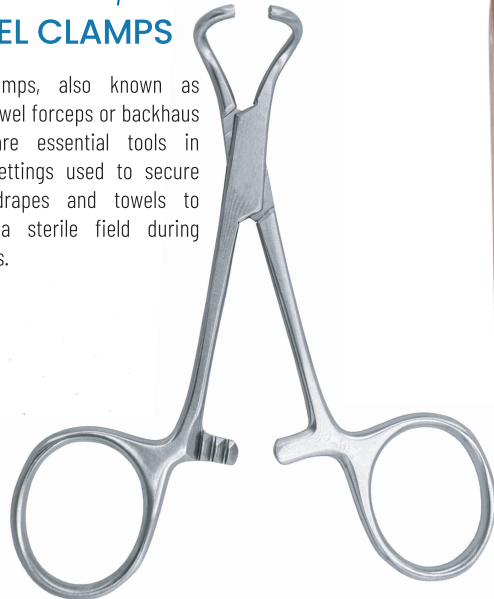

SUCTION TUBE

To draw out body fluids during thoracic or ventral surgery.



DRESSING & TISSUE FORCEPS

Whether in cardiovascular, orthopedic, plastic surgery, or gynecology, our Dissecting forceps offer surgical professionals the utmost control and dexterity.

BLACK CASPAR LUMBAR SPECULUM



CUTTING FORCEPS

Tying and twisting tie wires and cutting off nails and screws.



Discover RELIABILITY

As medical students ourselves, we are aware that patients rarely present with straight cuts, and it is therefore essential to be rehearsed in all cut forms. Because of this, we have equipped our suture model with 14 wounds of unique shape, width and depth.



BONE CUTTING FORCEPS

Specifically designed to cut and shape bones during orthopedic procedures.

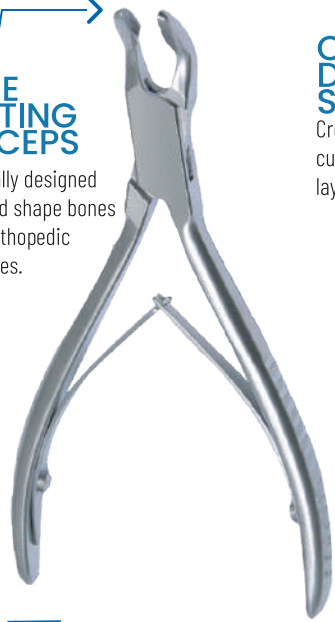

CONVERSE DURAL SCISSORS

Creating incisions and cutting through the Dural layer of the meninge



BONE RASP



SCALPEL HANDLES



DRESSING FORCEPS



MOSQUITO FORCEPS



BONE HOLDING CLAMPS



HOHMANN ELEVATOR



**QUALITY AND
LASTING
PERFORMANCE**

GELPI RETRACTORS

The Gelpi Retractor is a self-retaining tissue retraction for use during surgical procedures. Self-retaining retractors remain in place once they are positioned, freeing your hands.

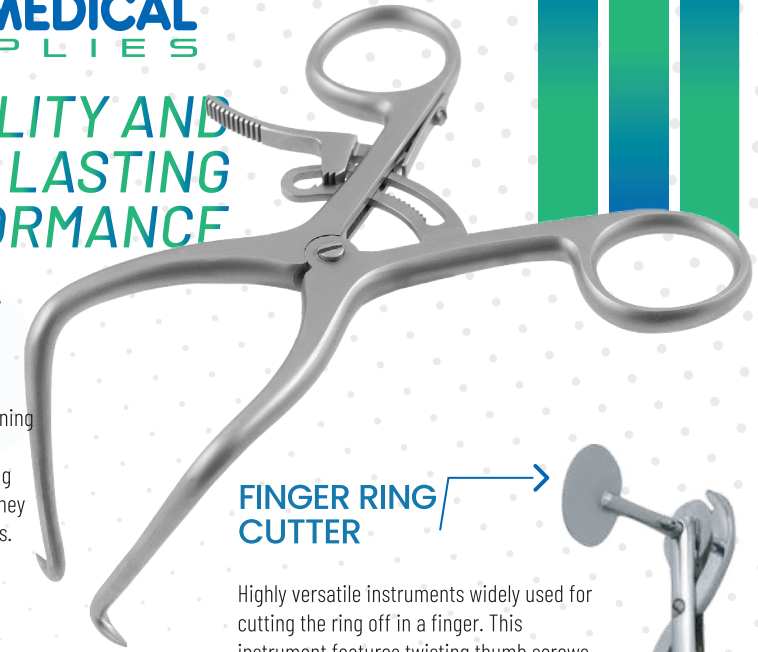

FINGER RING CUTTER

Highly versatile instruments widely used for cutting the ring off in a finger. This instrument features twisting thumb screws that allow the rotary blade to cut the circle while keeping the finger from the edge..



BONE REDUCTION CLAMPS

Bone Reduction Forceps are designed to minimize a fracture by re-positioning the fractured part. We offer these reduction forceps in straight and curved patterns to accommodate users.

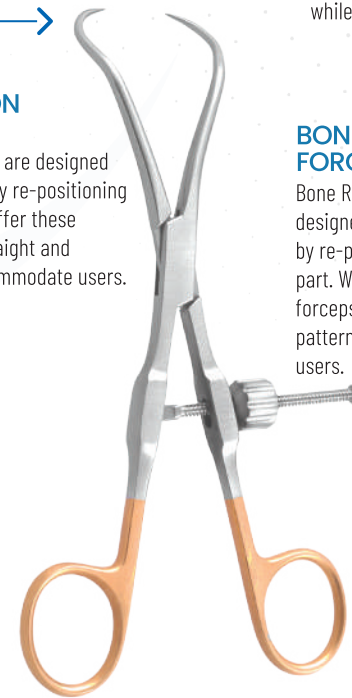

BONE REDUCTION FORCEPS

Bone Reduction Forceps are designed to minimize a fracture by re-positioning the fractured part. We offer these reduction forceps in straight and curved patterns to accommodate users.



We Do it Better.

Your Quest for Surgical Excellence Ends Here



ENT
Instruments



Orthopedic
Instruments



General
Surgical



Dental
Instruments



Hospital
Furniture



Ophthalmic
Instruments



Noal More, Roras Road,
Sialkot 51310 Pakistan

+92 323 430 38 62

info@caremedical.com.pk

www.caremedical.com.pk