



CARE MEDICAL
SUPPLIES

DENTAL
INSTRUMENTS
CATALOGUE



"Your Health Our Priority"

www.caremedical.com.pk

Company Profile

We have the honor to present our website catalogue of Surgical Instruments, Dental Instruments, Ophthalmic Instruments and Holloware for your perusal reference.

We take this opportunity to introduce our self as CARE MEDICAL SUPPLIES is leading Manufacturers & Exporters of all type of Surgical, Dental, Ophthalmic Instruments & Holloware. We are running our business very successfully from last one decade and growing day by day with our excellent quality products and customer satisfaction approach. The company manufactures over 6000 products and is dedicated to provide supreme quality and service. All our administration and sales staff are highly trained, which enables us to continuously monitor and achieve complete customer satisfaction.

QUALITY ACHIEVEMENTS:

It is added that our company is also holder of certificates of international quality standards such as ISO-9001:2000, cGMP & CE Mark, which reflects the quality service of our instruments. We are interested not only to sale our products but also build a good and long-term relationship with our customers.

QUALITY POLICY:

CARE MEDICAL SUPPLIES is guaranteed for quality instruments. We have better workmanship and correct design. Products are tested at each stage of manufacturing to last stage of packing / dispatch to ensure proper working of the instruments. We at CARE MEDICAL SUPPLIES has an endeavor to increase market share and are committed to continually improve the effectiveness of quality management systems of our instruments by meeting the requirements of our customers. Throughout manufacturing we maintain complete traceability for all materials used. We therefore feel that our quality system is very effective and it helps us to maintain our tradition of only Producing Quality Products.

OUR MISSION:

Our mission is to provide premium quality, value and innovation to our customers in order for them to achieve maximum return on their investment. we try to achieve by utilizing effective corporate practices, efcient teamwork and synergetic organization culture. each individual in our team shall work towards total quality culture aiming for customer satisfaction.

Care Medical enjoy a very satisfactory position for dental instruments when we take a broader view of the products we offer our customers. We are focused on delivering the highest quality product and service in the dental industry in order to help dental professionals perform at their best.



Quality & Standards:

We have been honored with ISO 9001:2002, ISO 13485:2003 Certificates & Authorized CE Marking. We are FDA and SFDA Certified. We developed and manufactured in compliance with the most Stringent Quality requirements, from the initial selection of corrosion resistant chrome steel and the manufacturing and heat treatment right through to the final finish, inspection and testing.

Guarantee:

We believe in outstanding quality and durability so all the products we offer cover's international Guarantee in connect with appropriate and professional use.



R&D:

The Passion and the Desire to make surgeries as smooth and as easy our department continue to developed products that matters in health sector today. This will of continues struggle comes from our relationship as a human beings. We are committed to bring out the best solutions for our customers.

TABLE OF CONTENTS



SECTION

01

Extracting Forceps

Page 01 - 37



SECTION

02

Root Elevators

Page 38 - 59

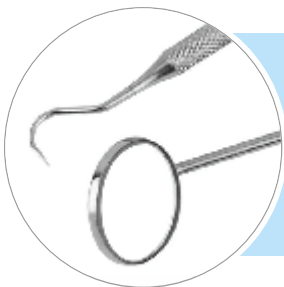

SECTION

03

Peridontia
Instruments

Page 60 - 106

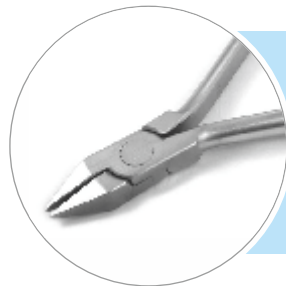

SECTION

04

Orthodontic
Instruments

Page 107 - 128



SECTION

05

Dental Surgery

Page 129 - 142

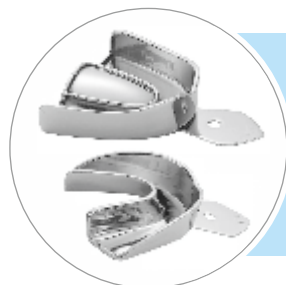

SECTION

06

Impression Tray

Page 143 - 146

TABLE OF CONTENTS

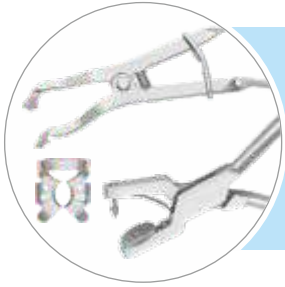

SECTION 07

Rubber Dam Clamp

Page 147 - 149

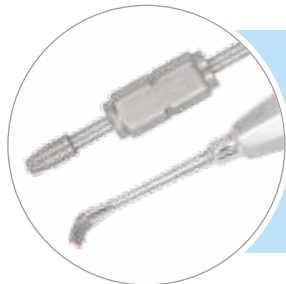

SECTION 08

Crown Removers &
Rongeurs

Page 150 - 159

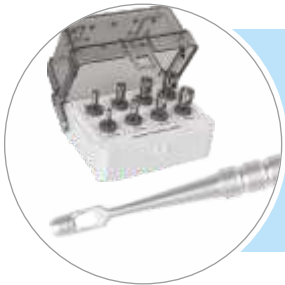

SECTION 09

Implant Instruments

Page 160 -170



SECTION 10

Dental Syringes

Page 171 - 174



SECTION 11

Hollow Ware

Page 175 - 190



CARE MEDICAL[®]
SUPPLIES

Your health _ Our Priority

Section

01

Page 01-37

Extracting Forceps



inspiring
confidence in
health
care

www.caremedical.com.pk

Extraction Forceps Grips Choices



Conventional



Titanium Black



Titanium Gold



Titanium Blue

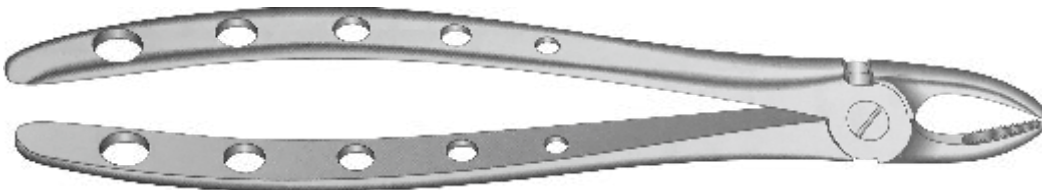

Super Light

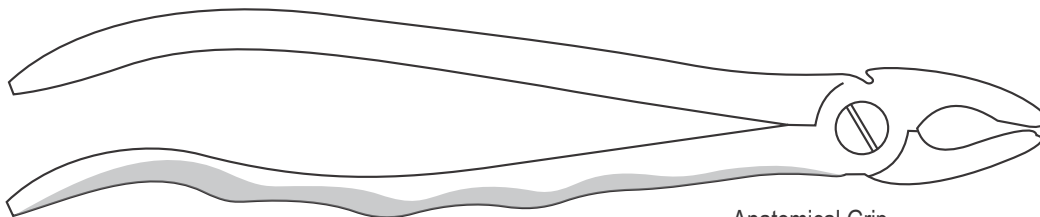

Anatomical Grip

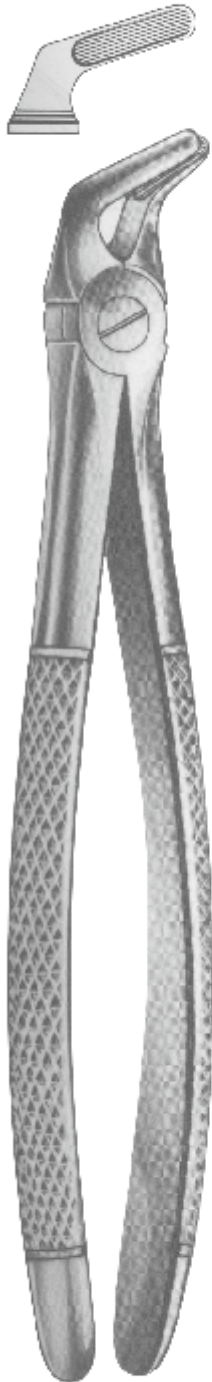

CM-1001
Fig 8
lower premolars

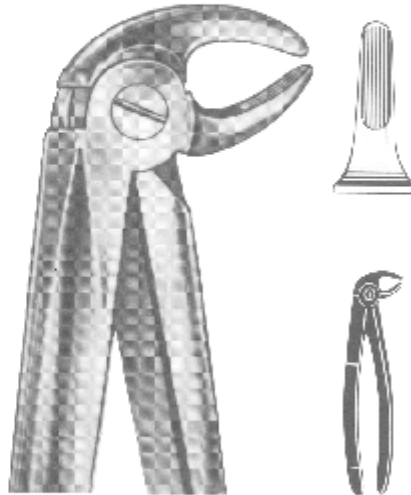

CM-1002
Fig 13
lower premolars

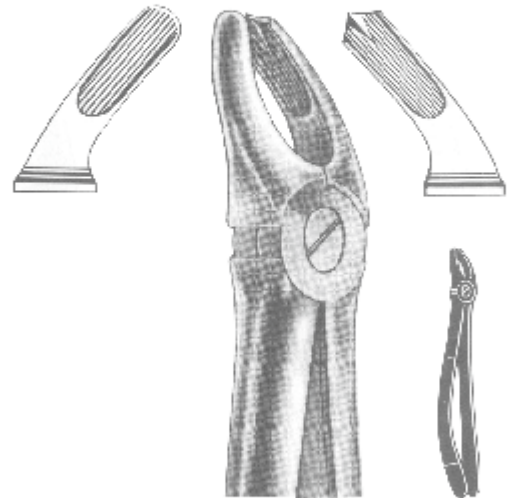

CM-1003
Fig 17
upper molars, right

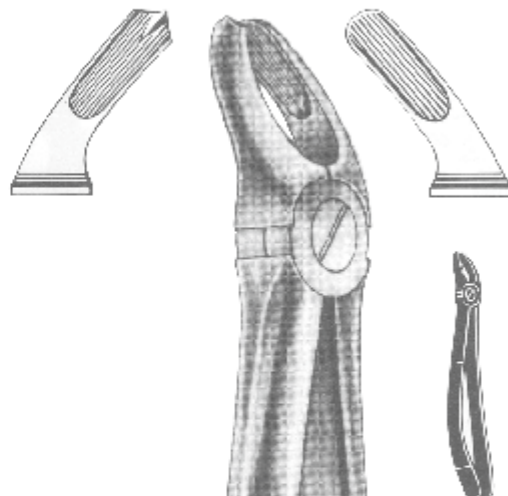

CM-1004
Fig 18
upper molars, left

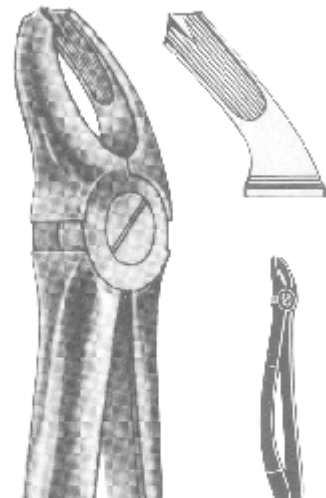

CM-1005
Fig 18 A
upper molars

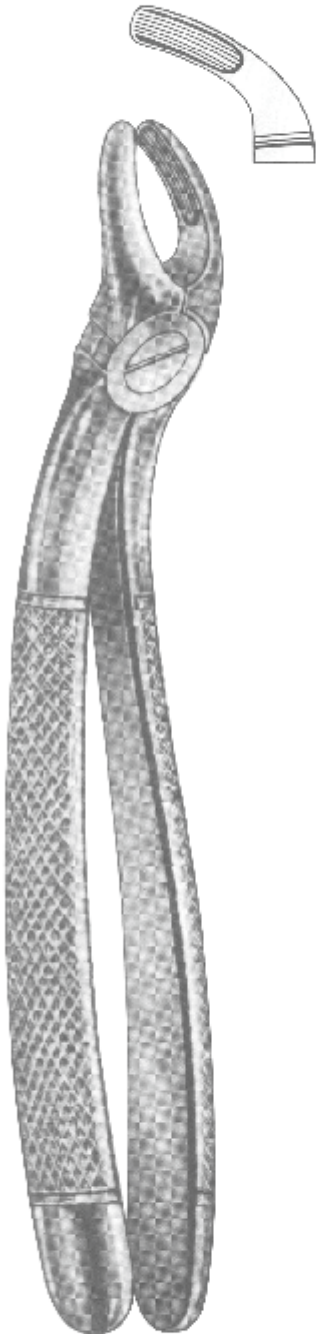

CM-1006
Fig 19
upper wisdoms

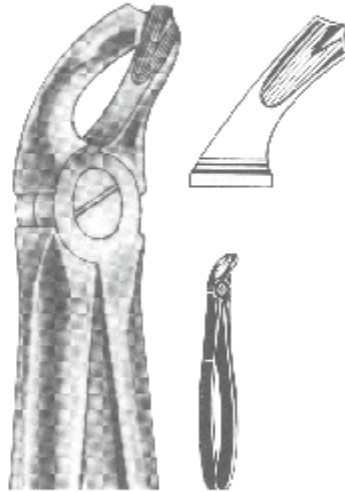

CM-1007
Fig 20
lower wisdoms

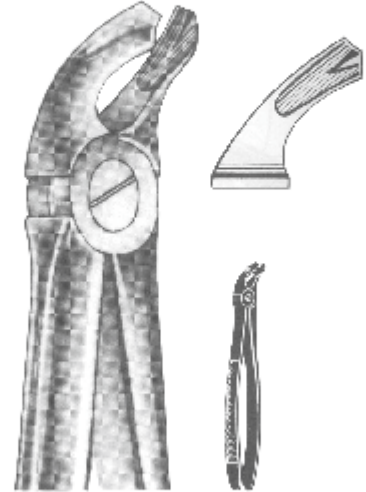

CM-1008
Fig 21
lower molars



CM-1009
Fig 22
lower molars

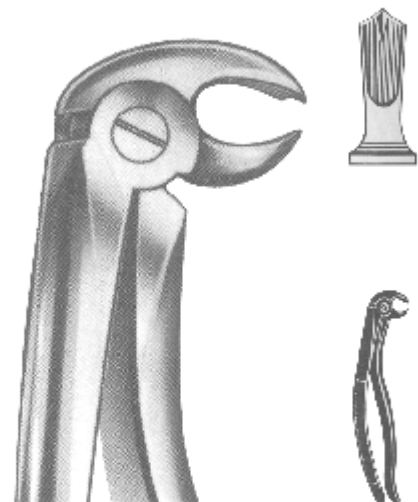

CM-1010
Fig 22 A
Albrecht
lower molars

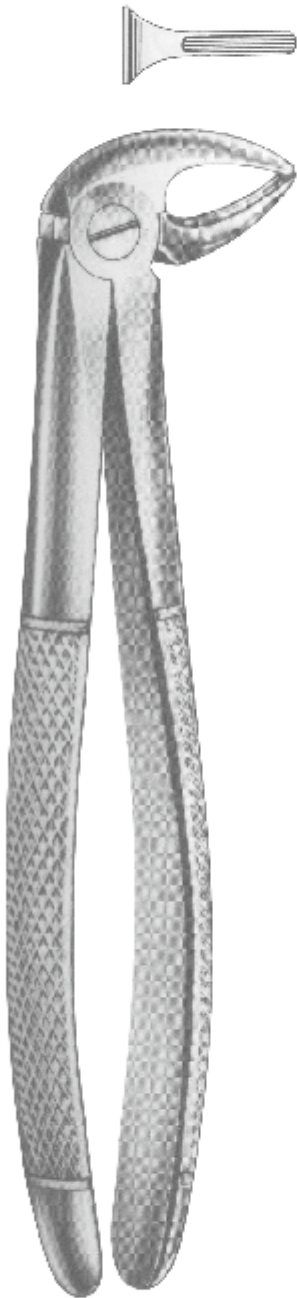

CM-1011
Fig 33 A
lower roots

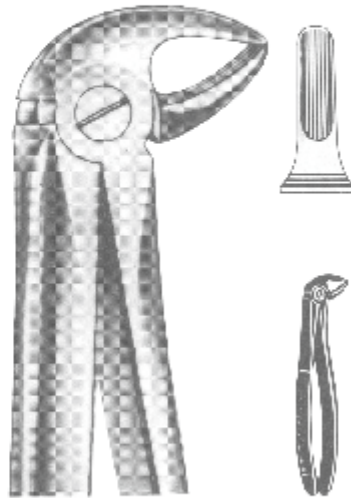

CM-1012
Fig 33 B
lower roots

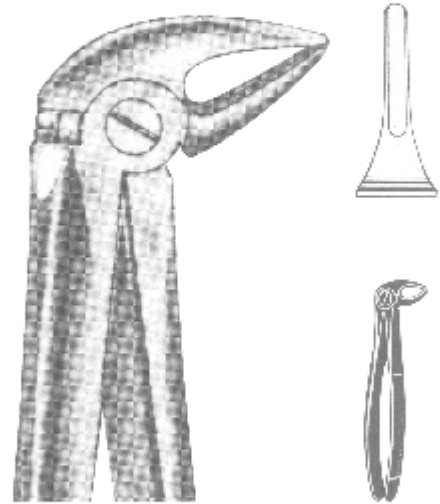

CM-1013
Fig 33 L
lower roots

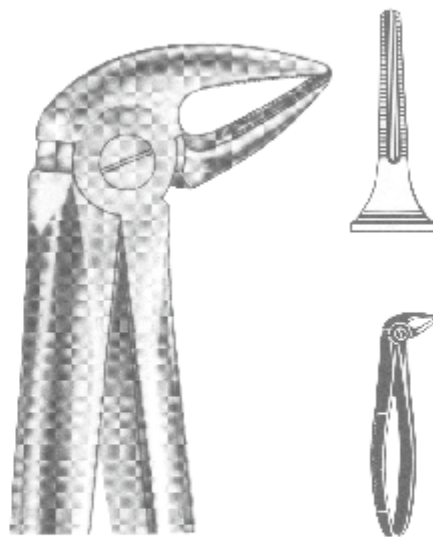

CM-1014
Fig 33 L
lower roots



CM-1015
Fig 33 S
lower roots, for children

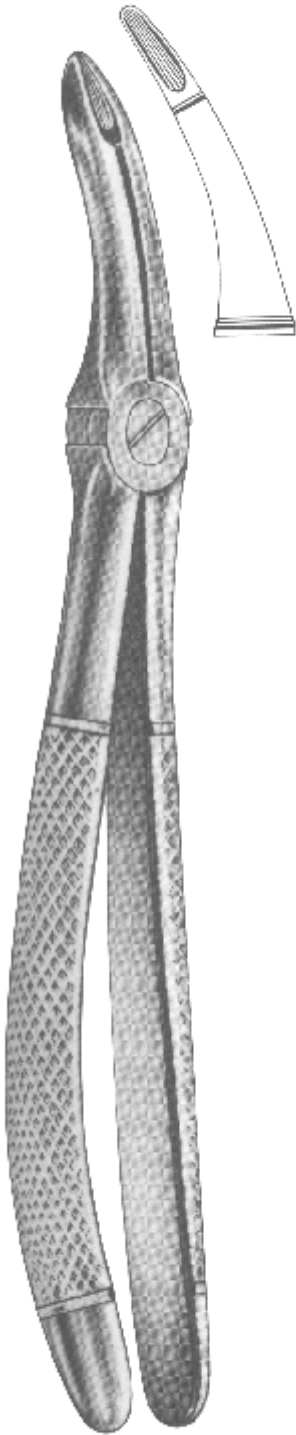

CM-1016
Fig 44
upper roots

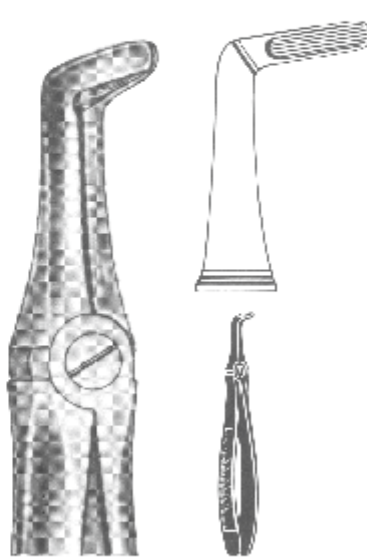

CM-1017
Fig 45
lower roots

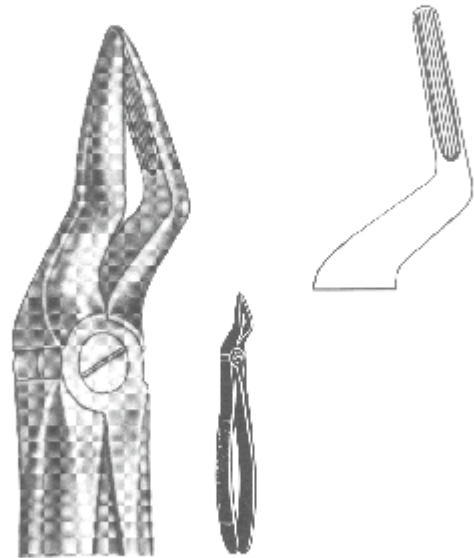

CM-1018
Fig 12
upper roots

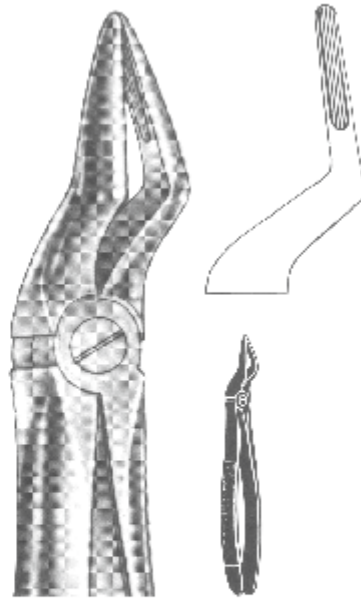

CM-1019
Fig 51 A
upper roots

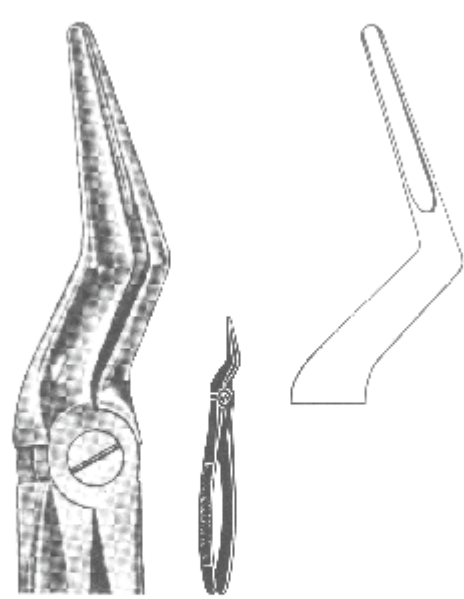

CM-1020
Fig 51 L
upper roots

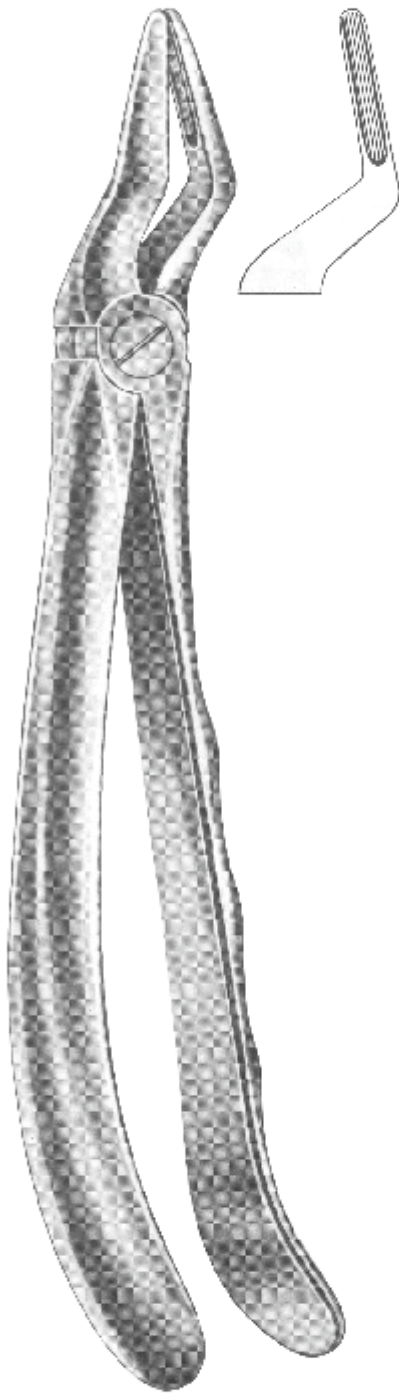

**Relax
CM-1021**
Fig 51
upper roots

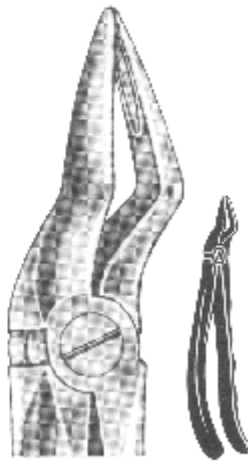

**Relax
CM-1022**
Fig 51 A
upper roots

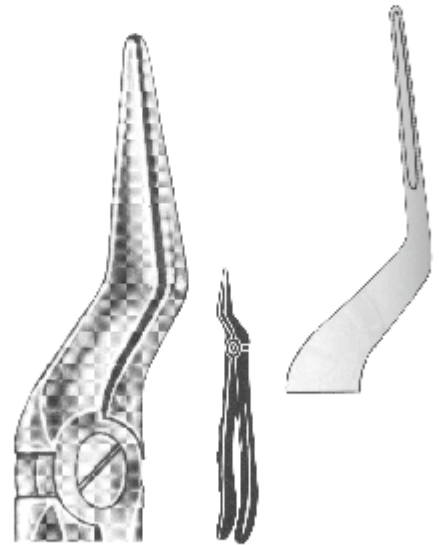

**Relax
CM-1023**
Fig 51 L
upper roots

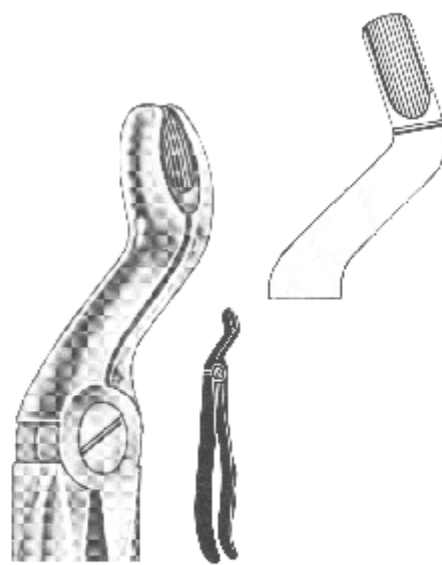

**Relax
CM-1024**
Fig 67
upper wisdoms

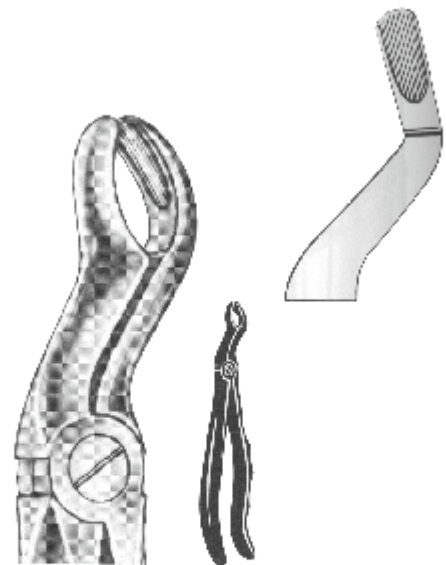

**Relax
CM-1025**
Fig 67 A
upper wisdoms



CM-1026
Fig 37
Upper incisors



CM-1027
Fig 39
Upper molars

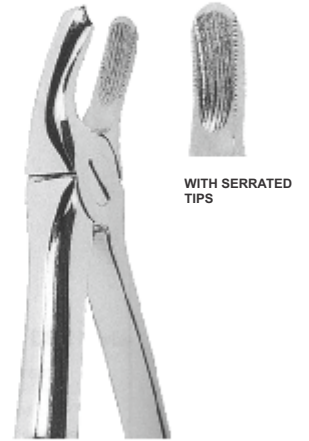

CM-1028
Fig 39 R
Upper molars, right



CM-1029
Fig 39 L
Upper molars, left



CM-1030
Fig 515
Upper roots



**Klein
CM-1032**
Fig 137
upper incisors

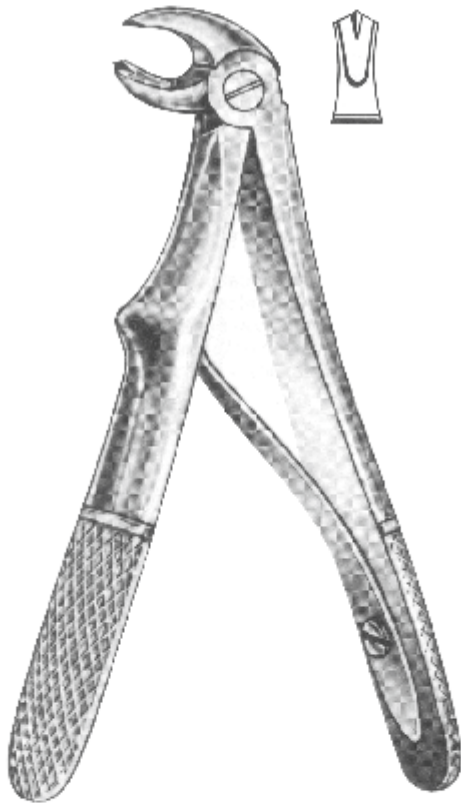

**Klein
CM-1031**
Fig 6
lower molars

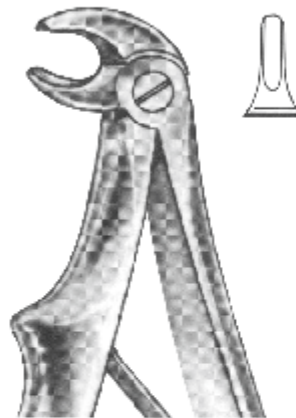

**Klein
CM-1033**
Fig 5
lower incisors

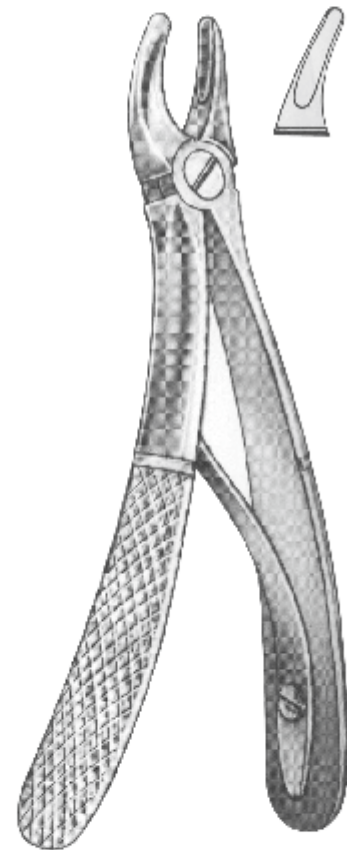

**Klein
CM-1034**
Fig 139
upper premolars



WITH SERRATED
TIPS

CM-1035
Fig 43 A
Fractured or decayed
upper teeth

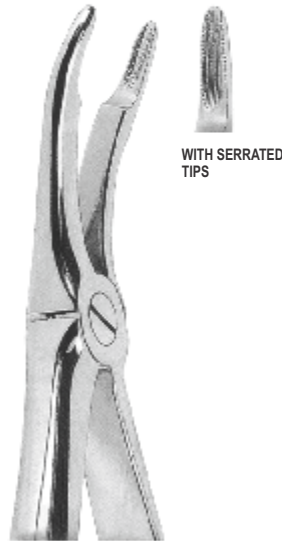

WITH SERRATED
TIPS

CM-1036
Fig 44
Upper roots



WITH SERRATED
TIPS

CM-1037
Fig 45
Lower roots

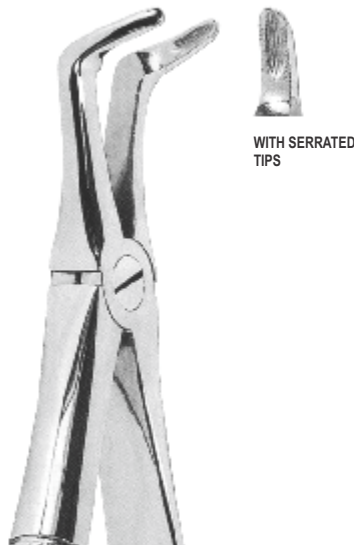

WITH SERRATED
TIPS

CM-1038
Fig 46
Lower roots



WITH SERRATED
TIPS

CM-1039
Fig 46 L
Lower roots



WITH SERRATED
TIPS

CM-1040
Fig 48
Upper roots

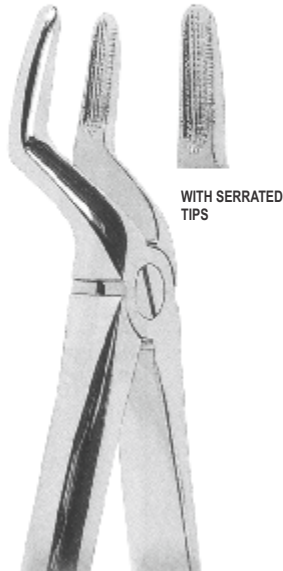

WITH SERRATED
TIPS

CM-1041
Fig 51
Upper roots

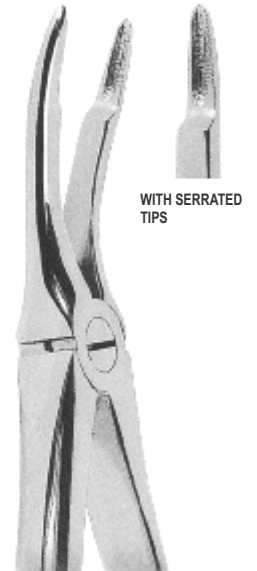

WITH SERRATED
TIPS

CM-1042
Fig 49
Upper roots

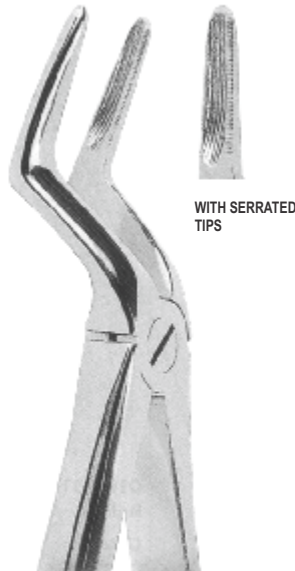

WITH SERRATED
TIPS

CM-1043
Fig 51 L
Upper roots

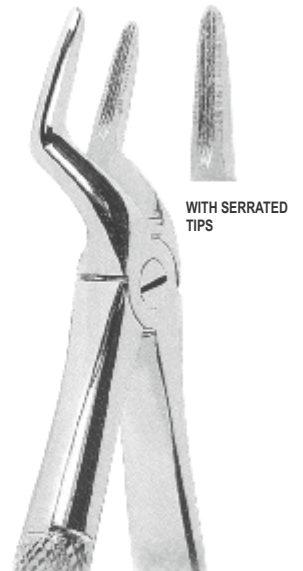

WITH SERRATED
TIPS

CM-1044
Fig 51 A
Upper roots



CM-1045
Fig 51 LX
Upper roots



WITH SERRATED
TIPS



CM-1046
Fig 52
Upper roots and
canines



WITH SERRATED
TIPS



CM-1047
Fig 54
For separating
upper molars



CM-1048
Fig 55
For separating
upper molars



CM-1049
Fig 56
For separating
lower molars



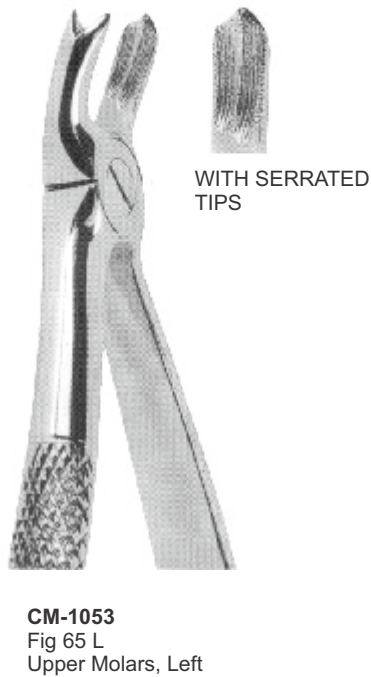
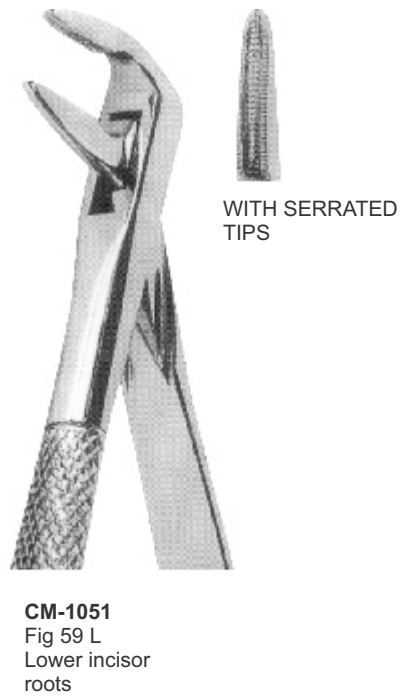



CM-1055
Fig 66 L
Upper molars, left



WITH SERRATED
TIPS



CM-1056
Fig 66 R
Upper molars, right



WITH SERRATED
TIPS



CM-1057
Fig 67
Upper three molars



WITH SERRATED
TIPS

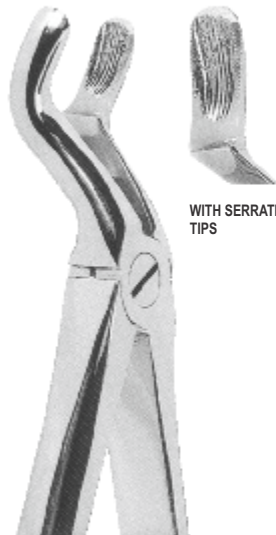

CM-1058
Fig 67 A
Upper third molars



WITH SERRATED
TIPS



CM-1059
Fig 68
Lower roots



WITH SERRATED
TIPS



CM-1060
Fig 67½ L
Upper third molars, left

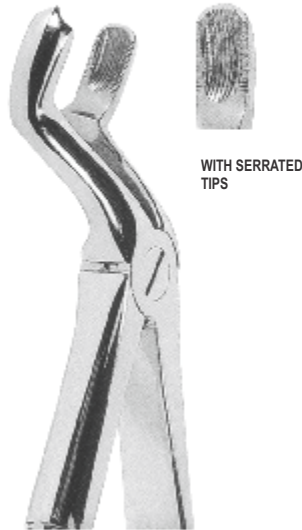

CM-1061
Fig 67½ R
Upper third molars, right



CM-1062
Fig 73
Lower molars



CM-1063
Fig 74
Lower roots

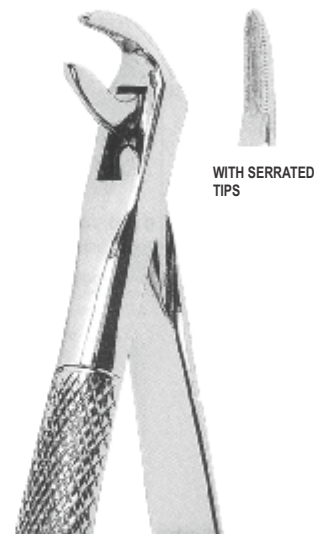

CM-1064
Fig 74 M
Lower roots



CM-1065
Fig 74 N
Lower roots



CM-1066
Fig 75
Lower canines and premolars

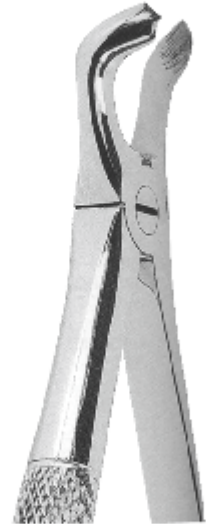

CM-1067
Fig 79
Lower third molars

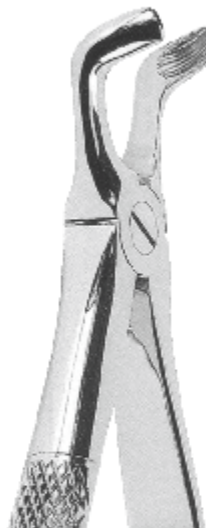

CM-1068
Fig 79 A
Lower third molars



CM-1069
Fig 79 C
Lower third molars



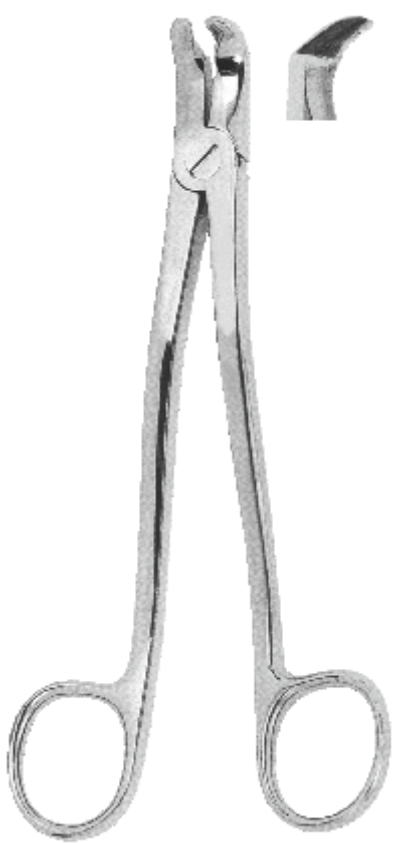

CM-1070
Fig 86 W
Lower third molars



CM-1071
Fig 86 1/2 L
Lower third molars, left



CM-1072
Fig 86 1/2 R
Lower third molars, right



CM-1073
Fig 86 C
Lower molars

Extraction Tweezers

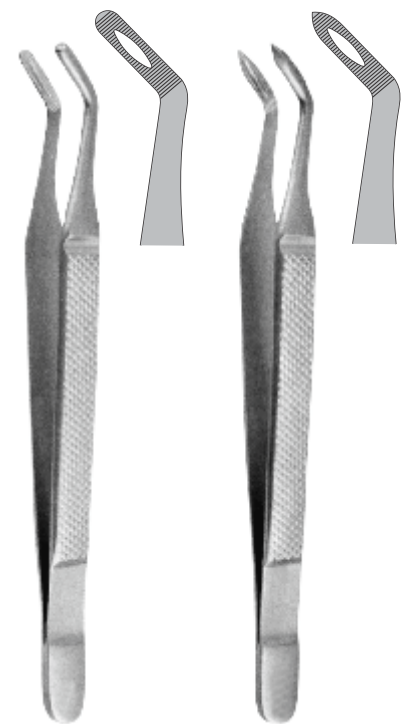

Fig. 1
CM-1074
Albrecht

Fig. 2
CM-1075
Albrecht

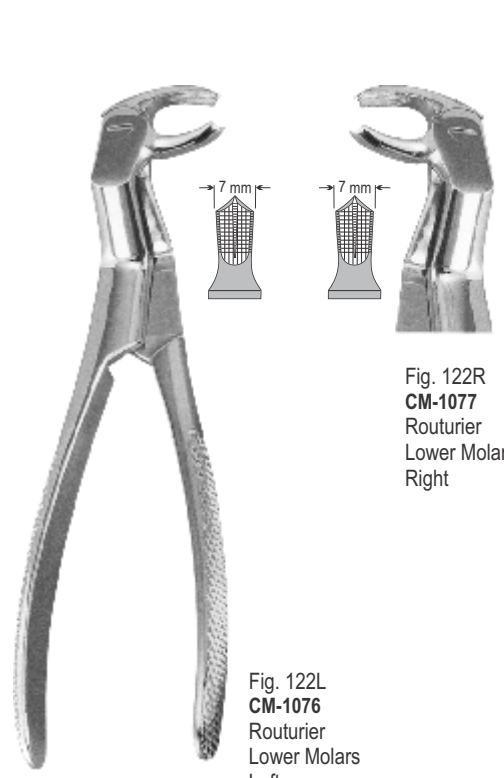

Fig. 122L
CM-1076
Roururier
Lower Molars
Left

Fig. 122R
CM-1077
Roururier
Lower Molars
Right



Fig. 1
CM-1078
Meissner



Fig. 2
CM-1079
Meissner



Fig. 3
CM-1080
Meissner



CM-1081
Fig 87
Lower decayed molars
or broken-down crowns



WITH SERRATED
TIPS

CM-1082
Fig 89
Upper molars, right

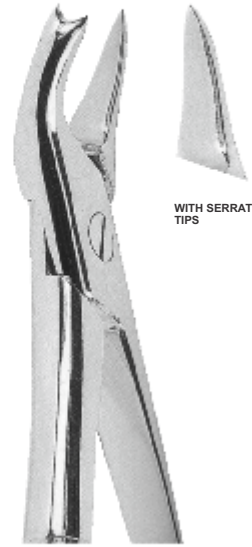

WITH SERRATED
TIPS

CM-1083
Fig 90
Upper molars, left

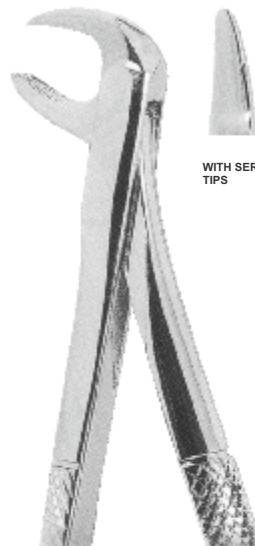

WITH SERRATED
TIPS

CM-1084
Fig 99
Broken-down lower molars

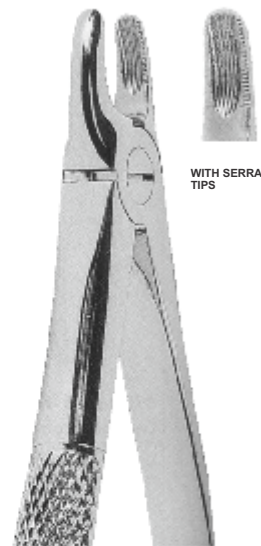

WITH SERRATED
TIPS

CM-1085
Fig 107
Upper canines



CM-1086
Fig 121
Upper third molars



CM-1087
Fig 145
Lower roots



CM-1088
Fig 151½
Upper roots

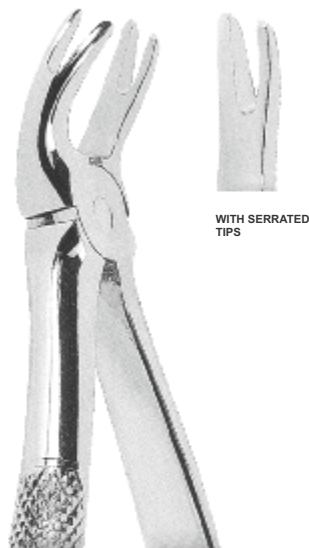

CM-1089
Fig 166
Universal extracting forceps for upper teeth, in particular molars and premolars



CM-1090
Fig 167
Universal extracting forceps for lower teeth, in particular molars and premolars



CM-1091
Fig 168
Upper canines



CM-1092
Fig 169
Lower canines

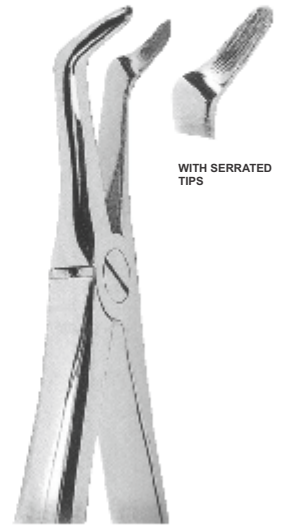

CM-1093
Fig 346
Lower roots

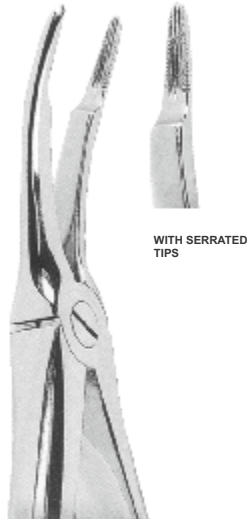

CM-1094
Fig 349
Upper roots

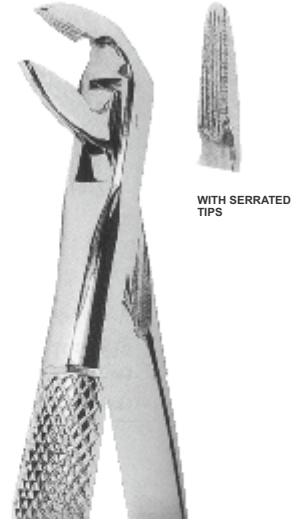

CM-1095
Fig 359
Lower roots



CM-1096
Fig 1
Universal extracting forcep for upper incisors and canines

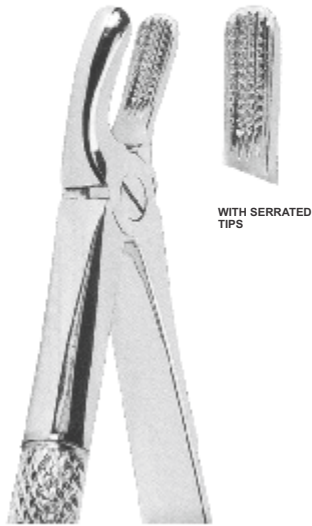

CM-1097
Fig 2
Upper molars

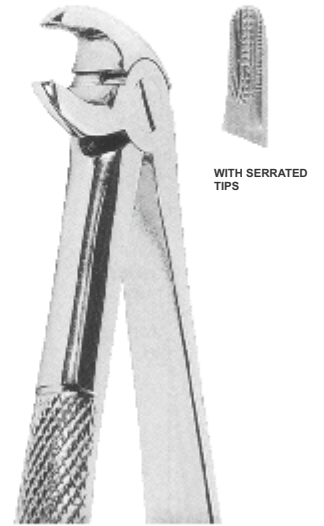

CM-1098
Fig 3
Lower incisors, premolar and roots

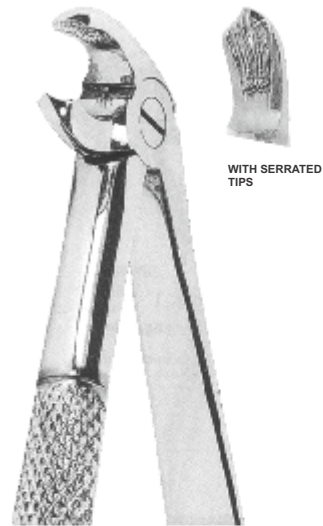

CM-1099
Fig 4
Lower molars



CM-1100
Fig 1
Upper incisors
and canines

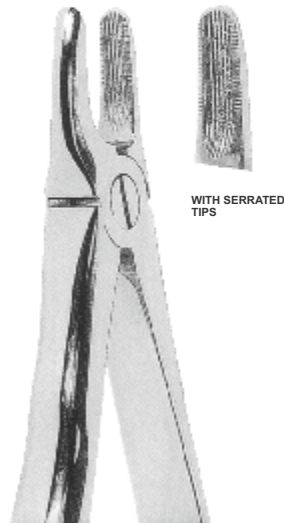

CM-1101
Fig 2
Upper incisors
and canines

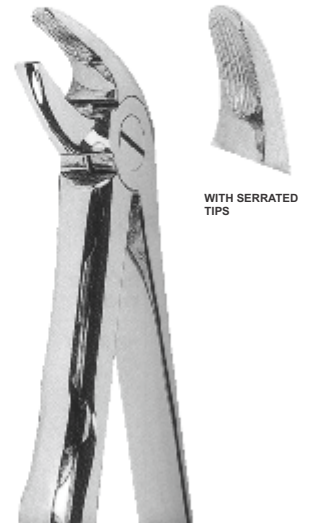

CM-1102
Fig 4
Lower incisors
and canines

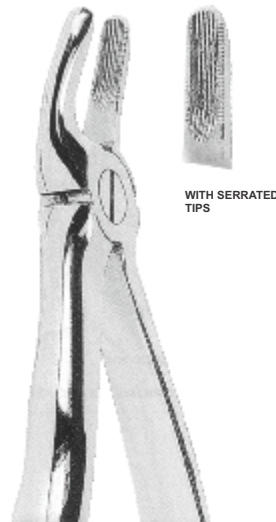

CM-1103
Fig 7
Upper premolars



CM-1104
Fig 13
Lower premolars



CM-1105
Fig 17
Upper molars, right

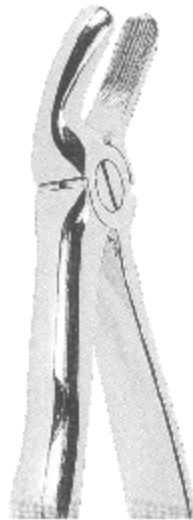

WITH SERRATED TIPS

CM-1106
Fig 18
Upper molars, left

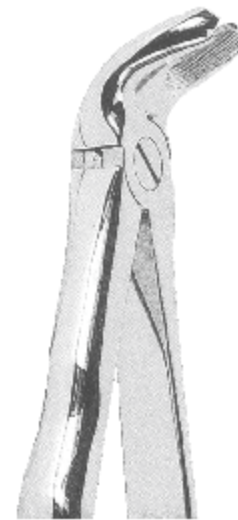

WITH SERRATED TIPS

CM-1107
Fig 21
Lower molars

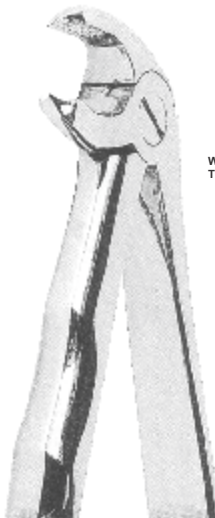

WITH SERRATED TIPS

CM-1108
Fig 22
Lower molars

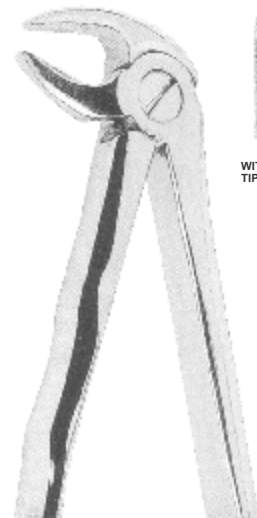

WITH SERRATED TIPS

CM-1109
Fig 33
Lower roots



CM-1110
Fig 45
Lower roots



WITH SERRATED TIPS



WITH SERRATED TIPS

CM-1111
Fig 51 A
Upper roots

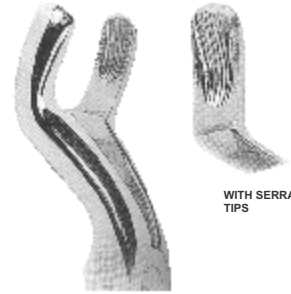

WITH SERRATED TIPS

CM-1112
Fig 67 A
Upper third molars



WITH SERRATED TIPS

CM-1113
Fig 74
Lower roots

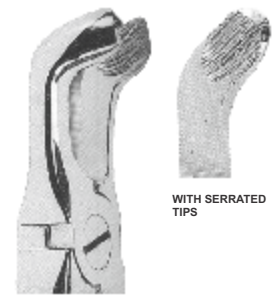

WITH SERRATED TIPS

CM-1114
Fig 79
Lower third molars



WITH SERRATED TIPS

CM-1115
Fig 86 C
Lower molars



WITH SERRATED TIPS

CM-1116
Fig 359
Lower roots



CM-1117
Fig 89
Upper molars, right

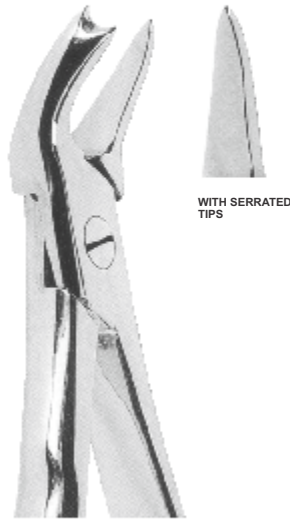

CM-1118
Fig 90
Upper molars, left

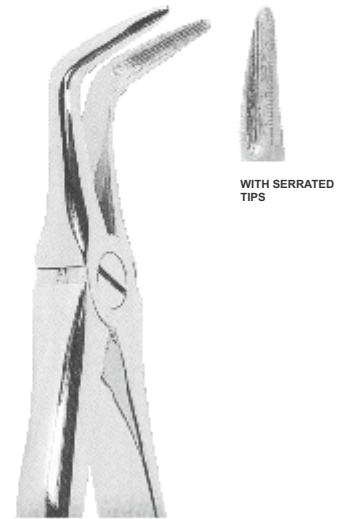

CM-1119
Fig 145
Lower roots

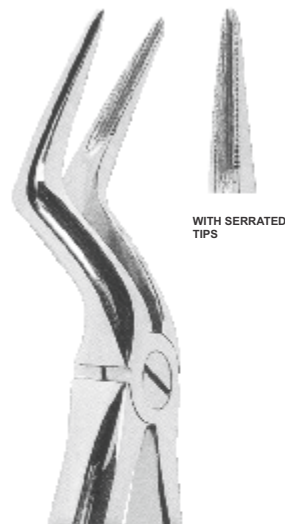

CM-1120
Fig 151 1/2
Upper roots

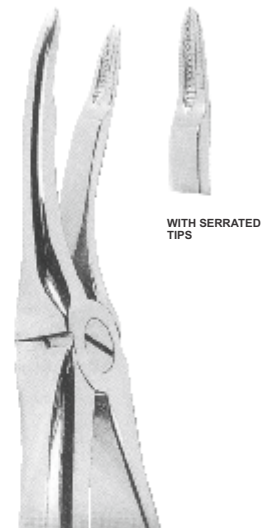

CM-1121
Fig 349
Upper roots



WITH SERRATED TIPS

CM-1122
Fig 135
Lower premolars



CM-1123
Fig 225
Lower molars

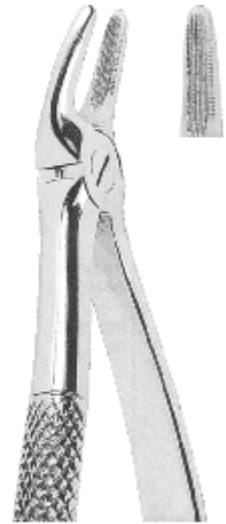

CM-1124
Fig 305
Upper incisors and roots



WITH SERRATED TIPS

CM-1125
Fig 33 S
Lower roots



WITH SERRATED TIPS

CM-1126
Fig 38
Lower incisors and canines



CM-1127
Set of 10 pieces
01, 07, 13, 17, 18, 22, 33A, 51A, 67A, 79



CM-1128
Set of 7 pieces
Children



CM-1129
Fig 1
Upper incisors



WITH SERRATED TIPS

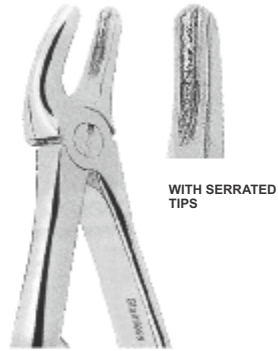

CM-1130
Fig 2
Upper permolars

WITH SERRATED TIPS



CM-1131
Fig 3
Upper molars

WITH SERRATED TIPS



CM-1132
Fig 4
Upper roots

WITH SERRATED TIPS



CM-1133
Fig 5
Lower incisors

WITH SERRATED TIPS

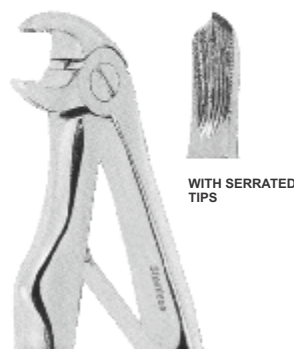

CM-1134
Fig 6
Lower molars

WITH SERRATED TIPS



CM-1135
Fig 7
Lower roots

WITH SERRATED TIPS



CM-1136
Fig 1
Lower roots



CM-1137
Fig 2
Upper roots



CM-1139
Fig 2
Roots fragments



CM-1138
Fig 1
Roots fragments

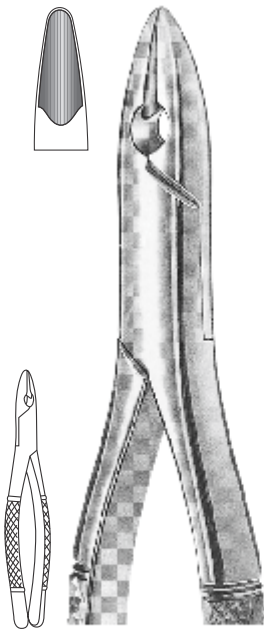

W1-Winter
CM-1140
Upper incisors & cuspids

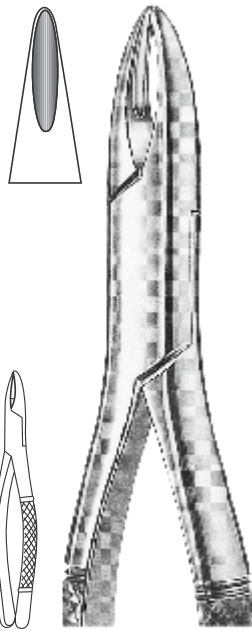

Fig. 1
CM-1141
Upper incisors



Fig. 2
CM-1142
Upper & Lower Roots

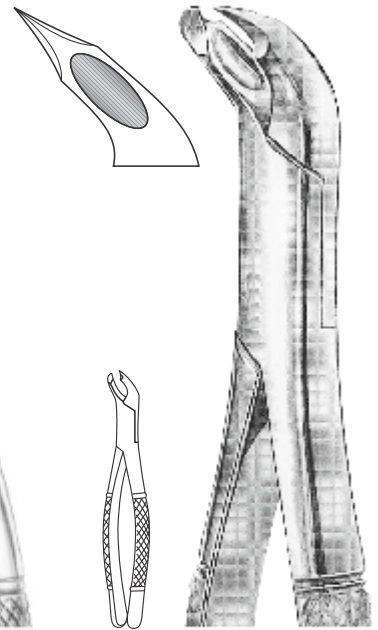

Fig. 3 FS
CM-1143
Woodward
Lower molars



Fig. 4
CM-1144
Upper & Lower Premolars

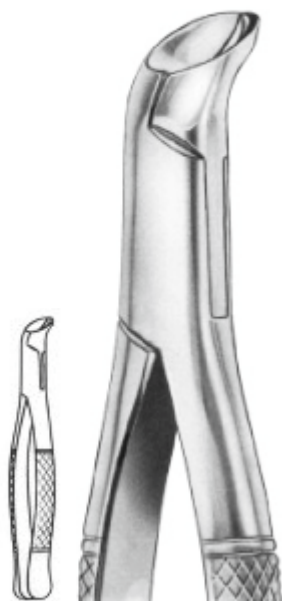

Fig. 5
CM-1145
Physick
Lower third molars

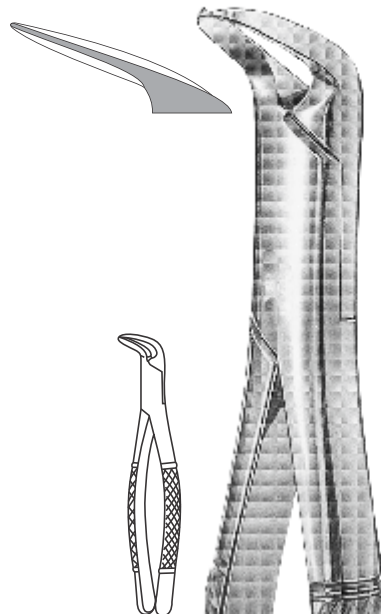

Fig. 6
CM-1146
Spaltzange
Splitting & Separating Forceps

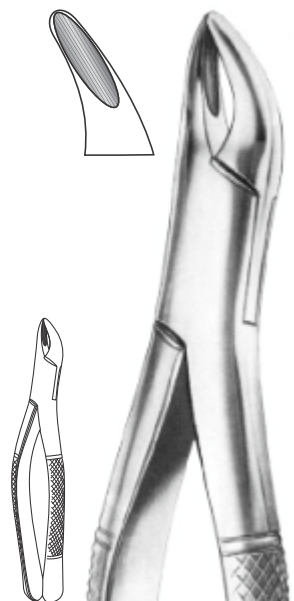

Fig. 7
CM-1147
Upper Roots

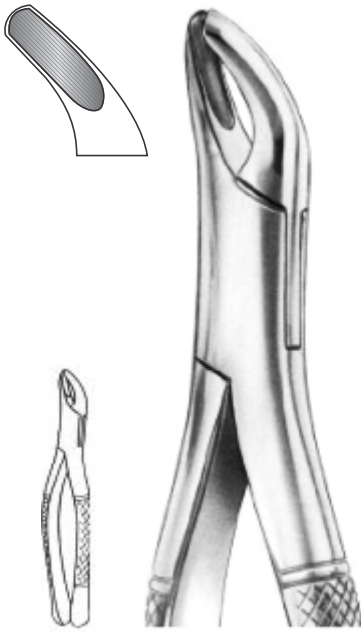

Fig. 8
CM-1148
Upper & Lower third molars

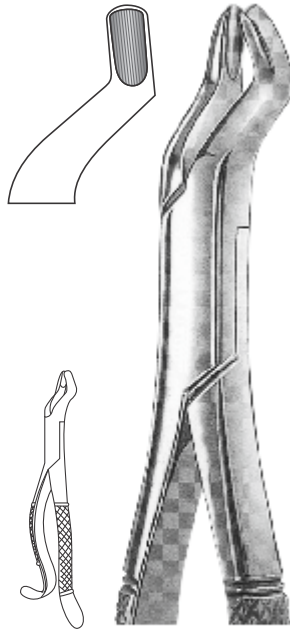

Fig. 10 H
CM-1149
Upper Molars, Hook Handle

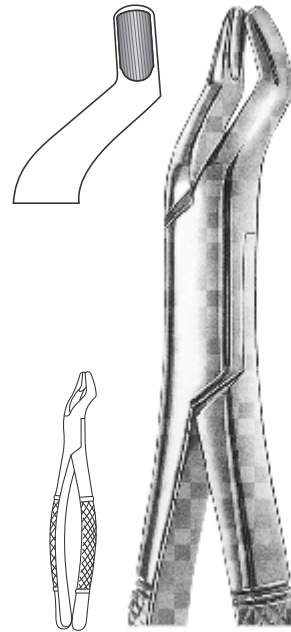

Fig. 10 S
CM-1150
Upper Molars

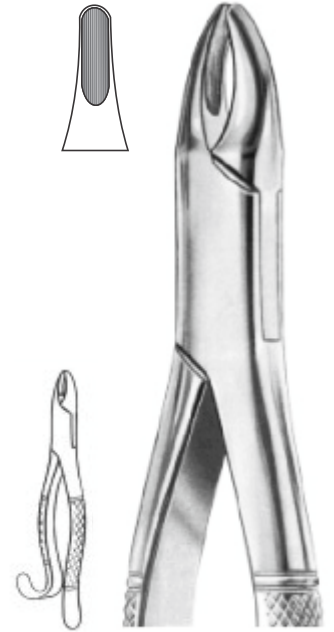

Fig. 13
CM-1151
Upper Incisors



Fig. 14
CM-1152
Lower Incisors

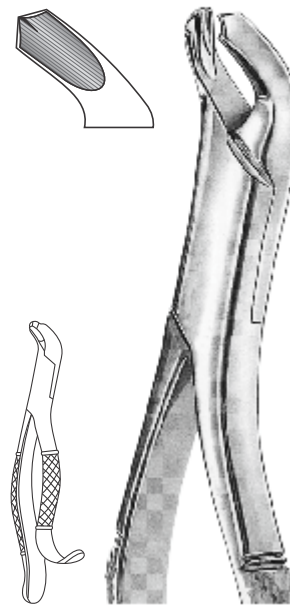

Fig. 15
CM-1153
1st & 2nd Lower Molars

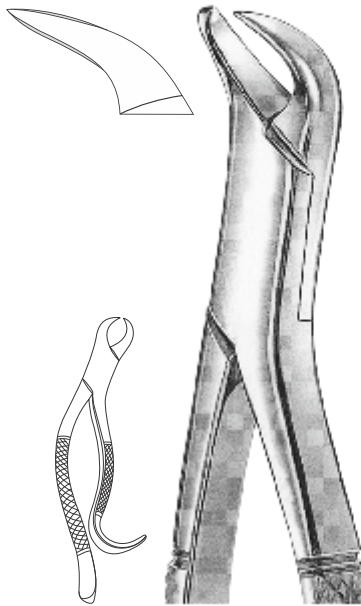

Fig. 16
CM-1154
"Cow Horn"
1st & 2nd Lower Molars

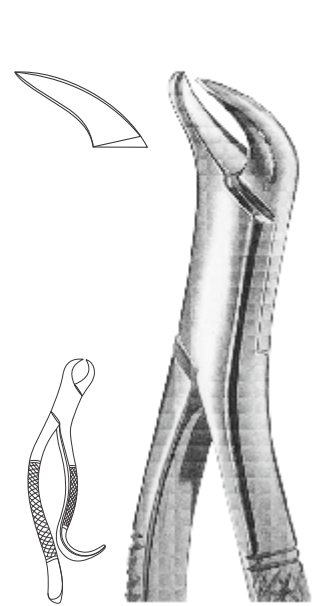

Fig. 16 SK
CM-1155
"Cow Horn"
Children, Lower Molars

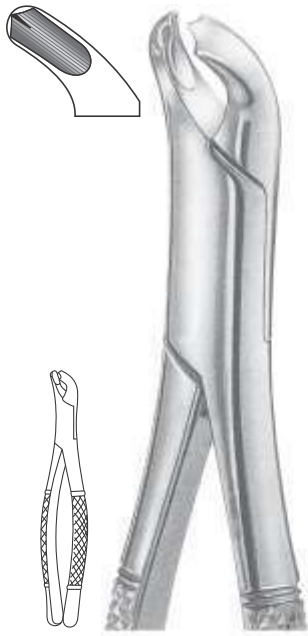

Fig. 17
CM-1156
CM-1157 Gold Plated
 1st & 2nd Lower Molars



Fig. 18 L
CM-1158
 1st & 2nd Upper Molars, left



Fig. 18 R
CM-1159
 1st & 2nd Upper Molars, right



Fig. 20 L
CM-1160
 Upper Molars left



Fig. 20 R
CM-1161
 Upper Molars right

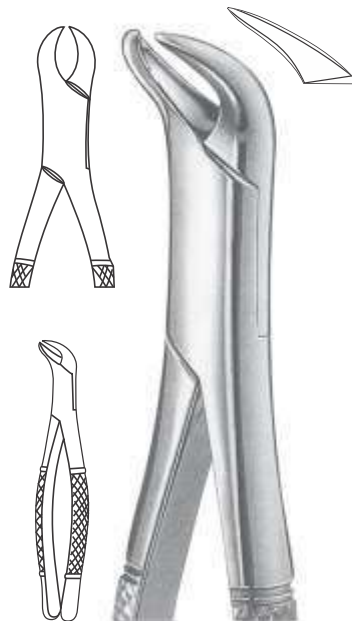

Fig. 23
CM-1162
 "Cow Horn"
 Lower Molars

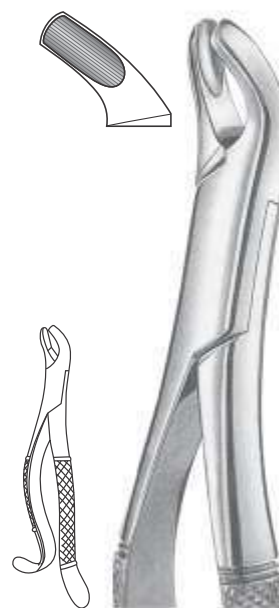

Fig. 24
CM-1163
 Upper Molars

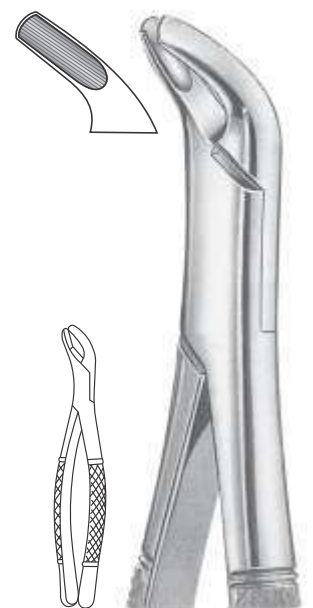

Fig. 27
CM-1164
 Upper Molars



Fig. 29 S
CM-1165
Lower teeth children



Fig. 30 S
CM-1166
Upper teeth children

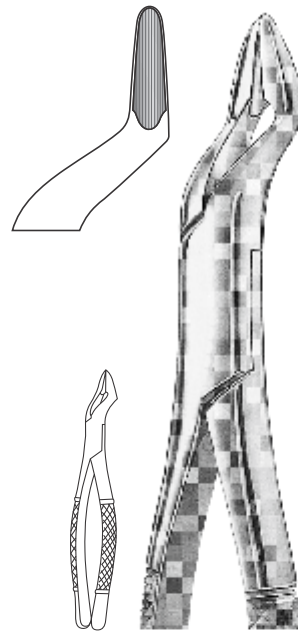

Fig. 32
CM-1167
Upper Bicuspid

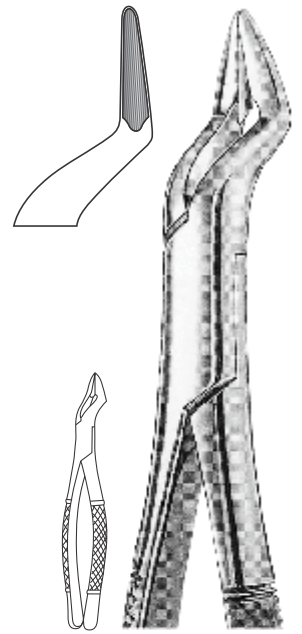

Fig. 32 A
CM-1168
Parnly
Upper Bicuspid & Roots



Fig. 34
CM-1169
Lower Anterior & Roots

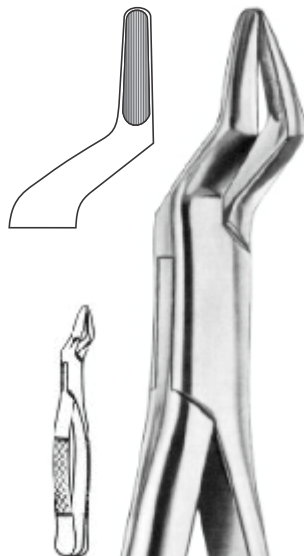

Fig. 35
CM-1170
Upper Roots



Fig. 36
CM-1171
Lower Anterior & Roots



Fig. 37
CM-1172
Lower Anterior & Roots



Fig. 38
CM-1173
Upper Anteriors & Roots

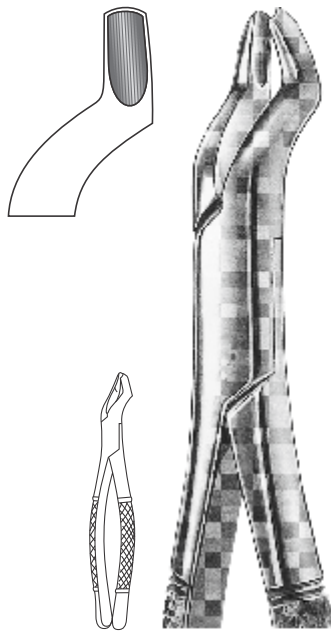

Fig. 53 L
CM-1174
CM-1175 Gold Plated
Upper Molars, left

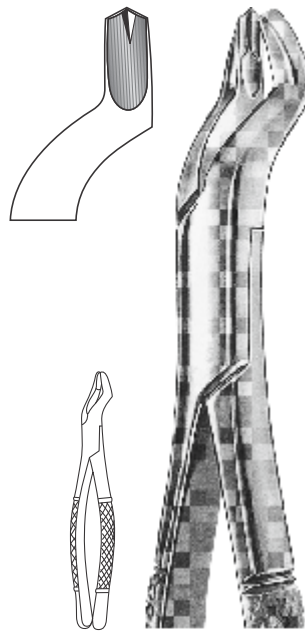

Fig. 53 R
CM-1176
CM-1177 Gold Plated
Upper Molars, right

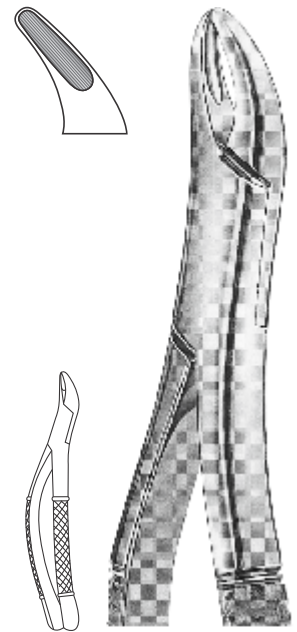

Fig. 62
CM-1178
Upper & Lower Incisors

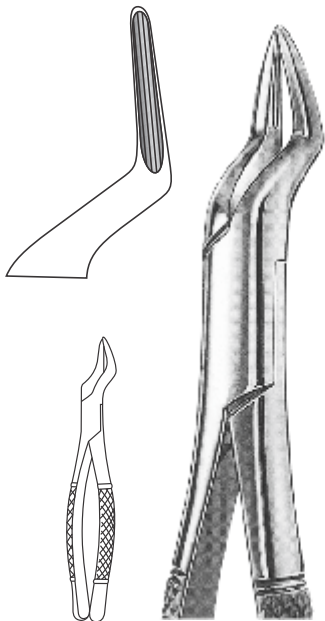

Fig. 65
CM-1179
CM-1180 Gold Plated
Upper Incisors, Roots & Fragments

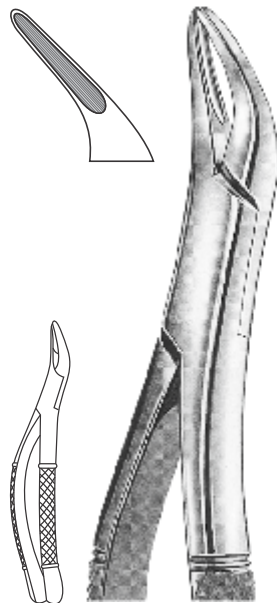

Fig. 69
CM-1181
CM-1182 Gold Plated
Upper & Lower Fragments & Roots

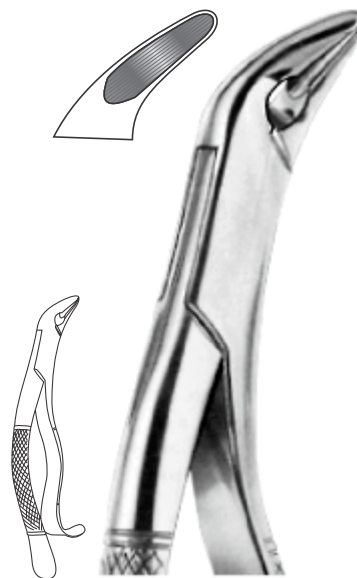

Fig. 85
CM-1183
lower canines,
premolars and molars

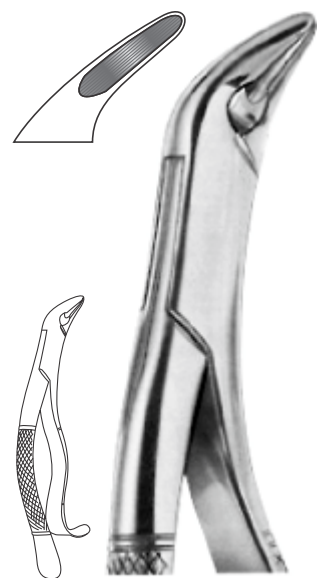

Fig. 85 A
CM-1184
lower canines,
premolars and molars

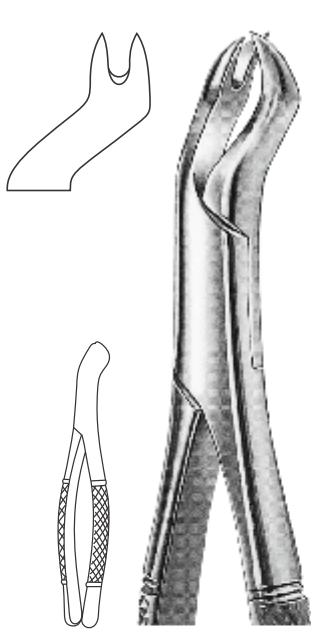

Fig. 88 L
CM-1185
Nevius
Upper Molars, left

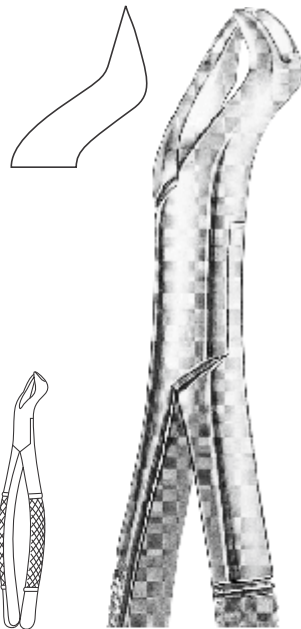

Fig. 88 R
CM-1186
Nevius
Upper Molars, right

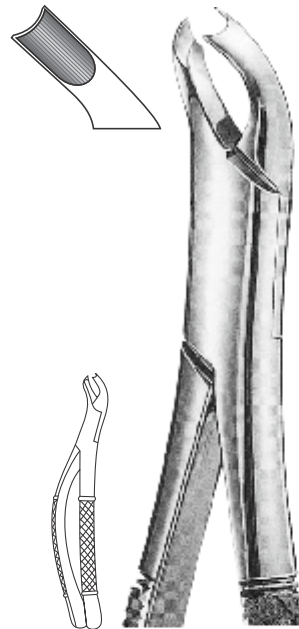

Fig. 89
CM-1187
Upper Molars, right

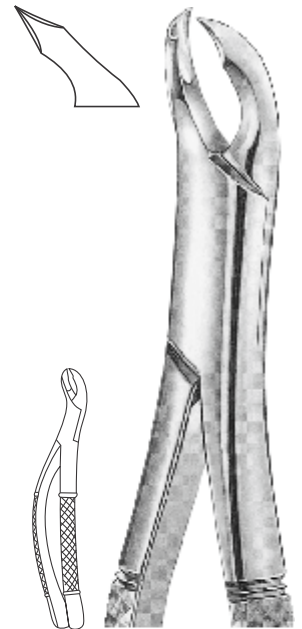

Fig. 90
CM-1188
Upper Molars, left

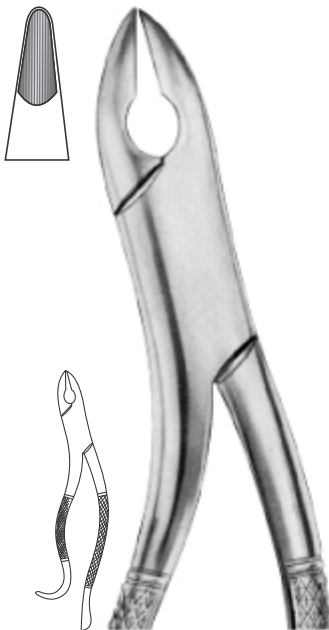

Fig. 99 A
CM-1189
Kells
Upper Incisors, Canines, Premolars

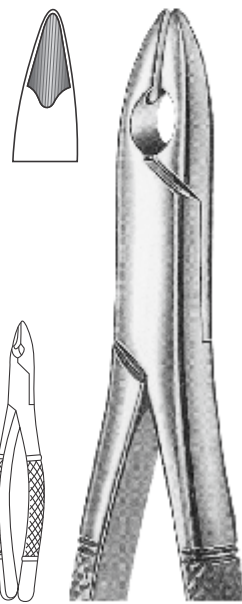

Fig. 99 C
CM-1190
Kells
Upper Incisors & Bicuspid

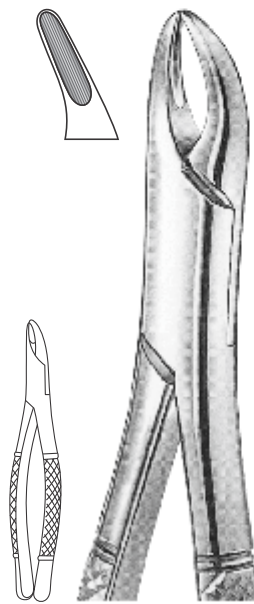

Fig. 101
CM-1191
Hull
Universal for Bicuspid & Deciduous

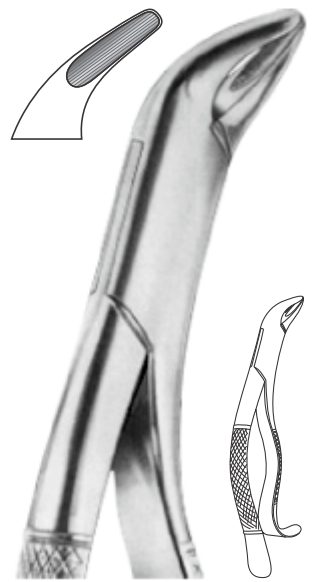

Fig. 103
CM-1192
lower incisors, premolars



Fig. 104
CM-1193
Upper third molars

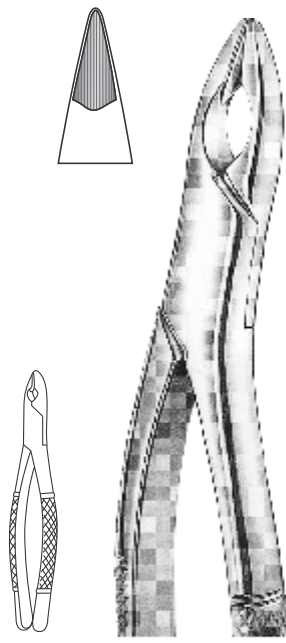

Fig. 110 S
CM-1194
Nevius
Upper Bicuspids & Cuspids

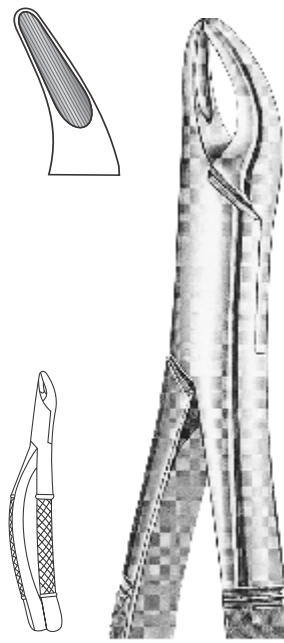

Fig. 150
CM-1195 Gold Plated
Cryer
Upper Incisors, Bicuspids & Roots

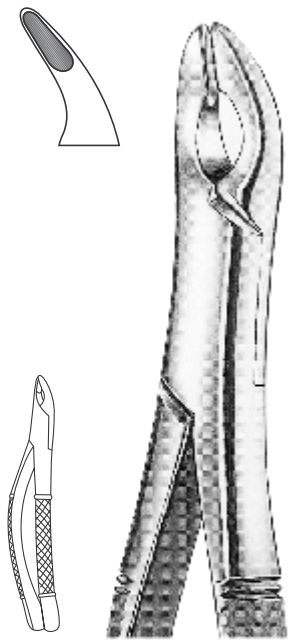

Fig. 150 A
CM-1197
Cryer
Upper Incisors,
Cuspids & Bicuspids

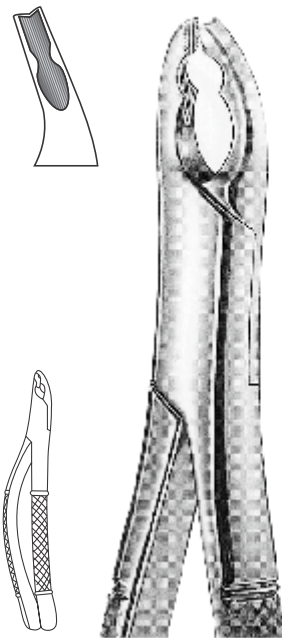

Fig. 150 AS
CM-1198 # 150 AS
Cryer
Upper Incisors, Cuspids
serrated jaw

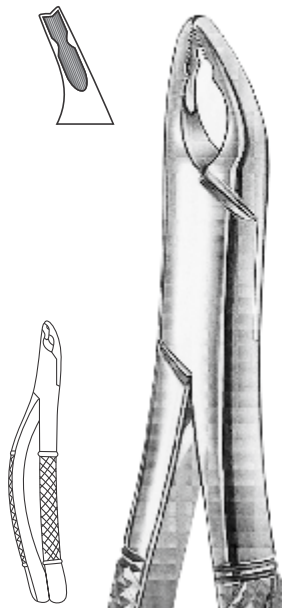

Fig. 150 XAS
CM-1199
Cryer
Children, Upper Incisors &
Cuspids, serrated jaw

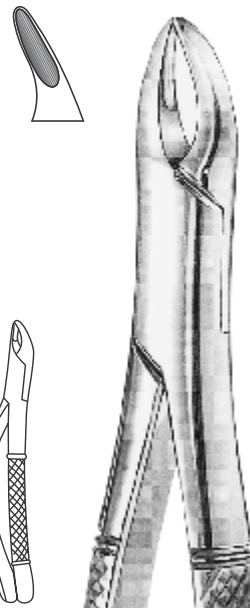

Fig. 150 S
CM-1200 Gold Plated
Cryer
Children, Upper Incisors, Bicuspids & Roots

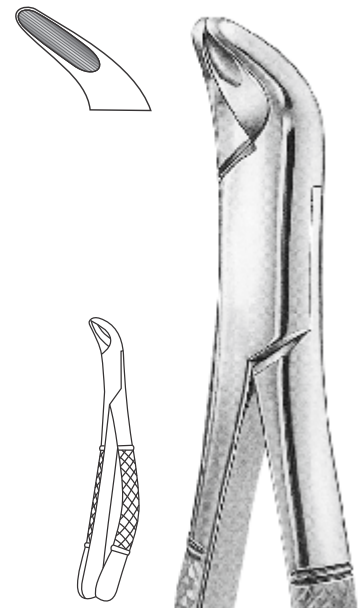

Fig. 151
CM-1202 Gold Plated
Cryer
Lower Incisors, Bicuspids & Roots

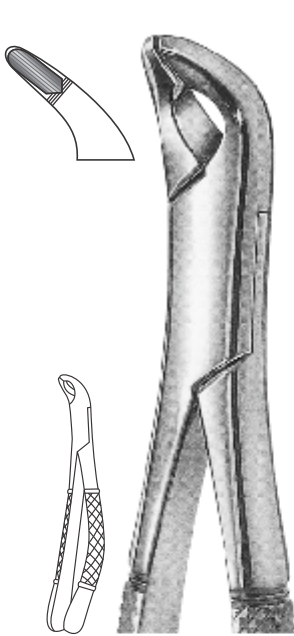

Fig. 151 A
CM-1204
Cryer
Lower Incisors, Cuspids
& Bicuspids

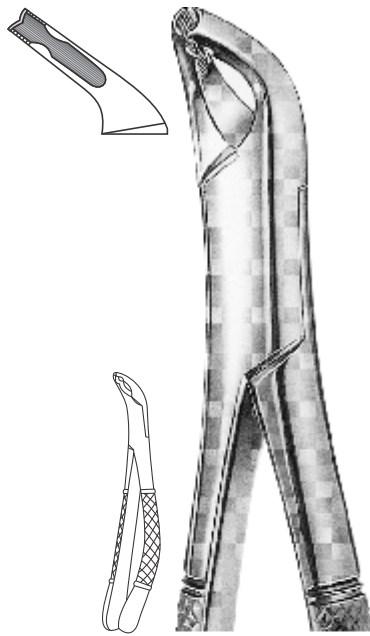

Fig. 151 AS
CM-1205
Cryer
Lower Incisors & Cuspids, serrated jaw

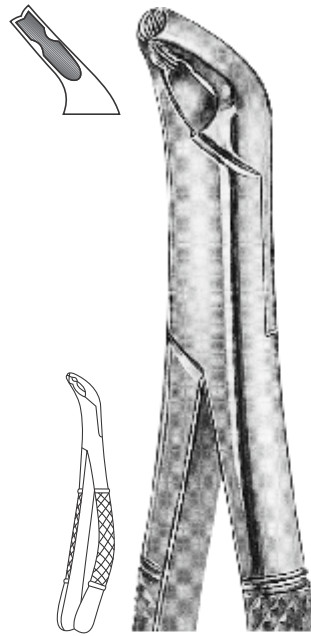

Fig. 151 XAS
CM-1206
Children, Lower Incisors &
Cuspids, serrated jaw

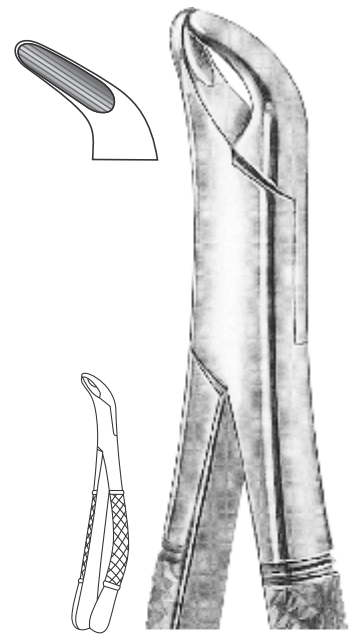

Fig. 151 S
CM-1207 Gold Plated
CM-1208 Gold Plated
Cryer
Children, Lower incisors, Bicuspids & Roots



Fig. 201
CM-1209
Upper Incisors,
Canines, premolars

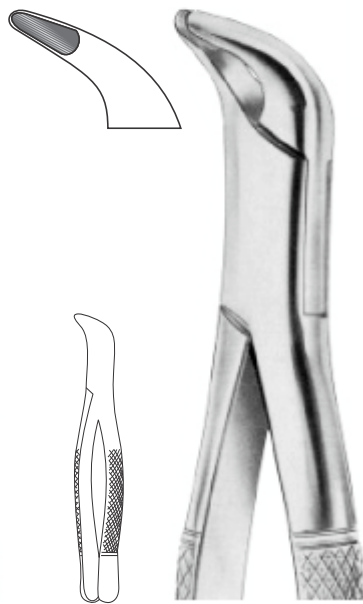

Fig. 203
CM-1210
Lower Incisors & Roots

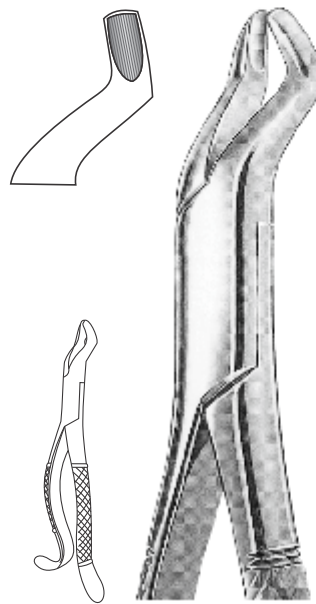

Fig. 210 H
CM-1211
Upper Wisdoms, Hook Handle

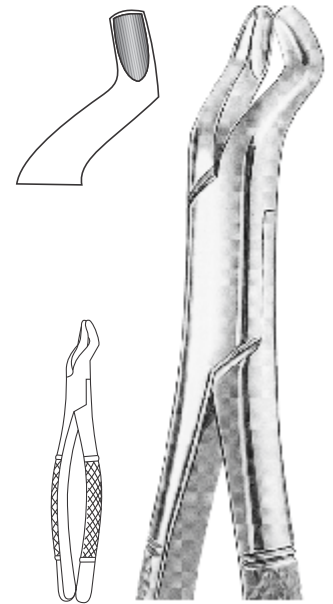

Fig. 210 S
CM-1212
Upper Wisdoms



Fig. 213
CM-1213
Upper Centrals & Canines

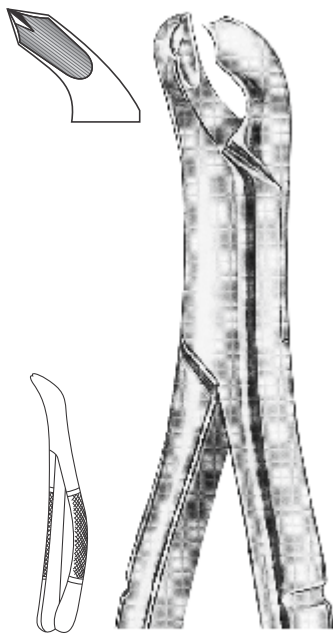

Fig. 217
CM-1214
Lower Molars

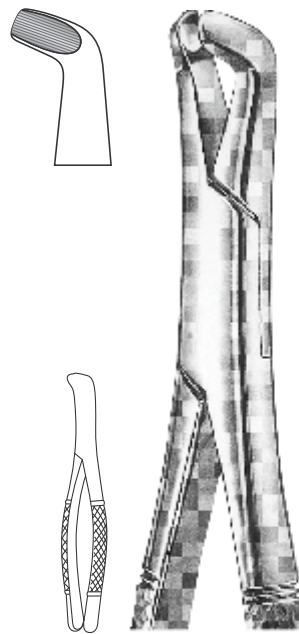

Fig. 222
CM-1215
Lower Wisdoms

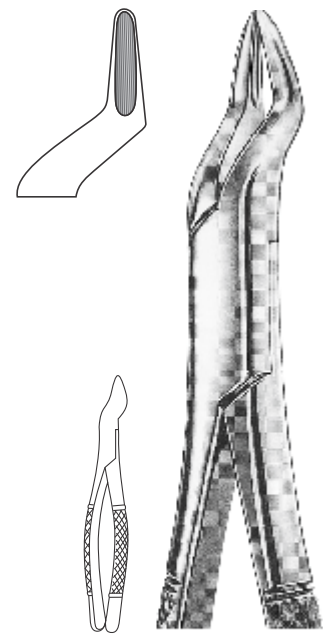

Fig. 286
CM-1216
Upper Incisors, Bicuspid & Roots



Fig. 286
CM-1217
Swing lower molars



Fig. 288
CM-1218
Lower Canines & Premolars

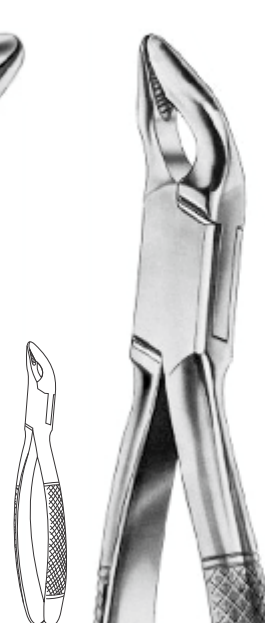

Fig. 310
CM-1219
Cohen
Universal Forceps

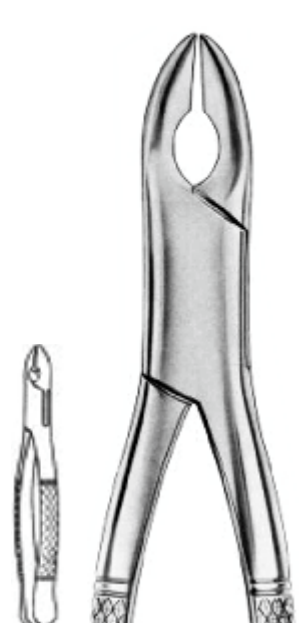

Fig. 320/10S
CM-1220
Nevius
Upper Canines

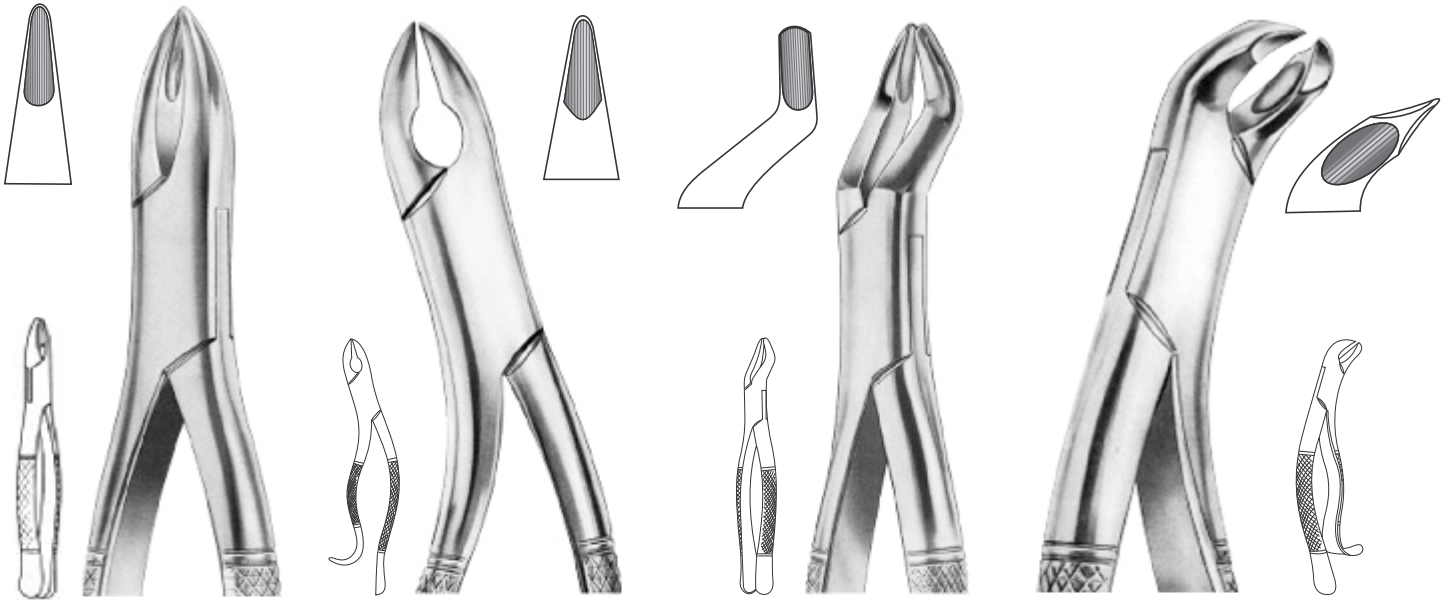

Fig. 315/1A
CM-1221
Henahan
Upper Incisors

Fig. 325/10H
CM-1222
Nevius
Upper Canines

Fig. 330/4
CM-1223
Standard
Upper Third Molars

Fig. 335/FH
CM-1224
Woodward
Lower Molars



Fig. 17 SK
CM-1225
Children Lower Molars

Fig. 23 SK
CM-1226
Children Lower Molars

Fig. 150 SK
CM-1227
Children, Upper Incisors,
Bicuspid & Roots

Fig. 151 SK
CM-1228
Children, Lower Incisors,
Bicuspid & Roots



CARE MEDICAL[®]
SUPPLIES

Your health _ Our Priority

Section

02

Page 38-59

Root Elevators



inspiring
confidence in
health
care

www.caremedical.com.pk

Root Elevators
Are Available In Following Handles

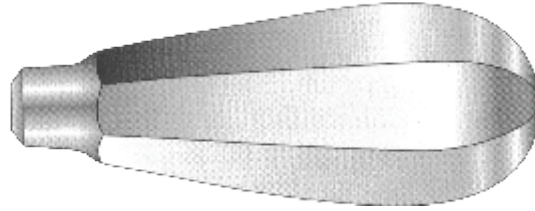

Small Handle

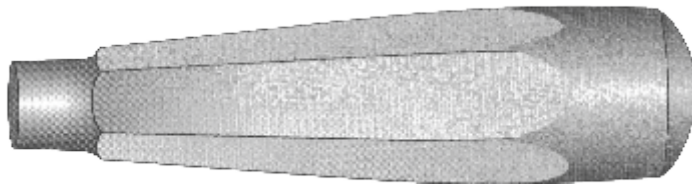

SB
Shot Blasted Handle

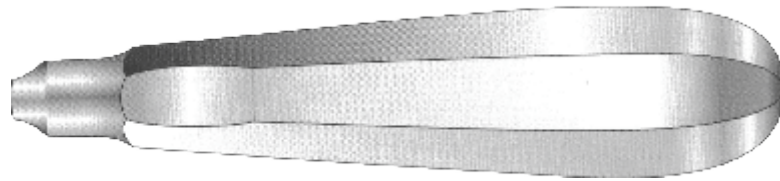

Regular Handle

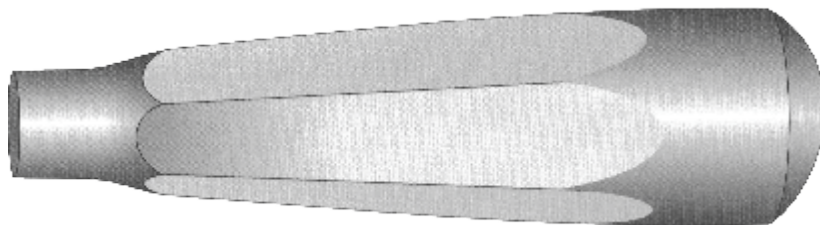

SP
Special Pattern



Ergonomic Handle Tin Coated

lower jaw, left side

lower jaw, right side

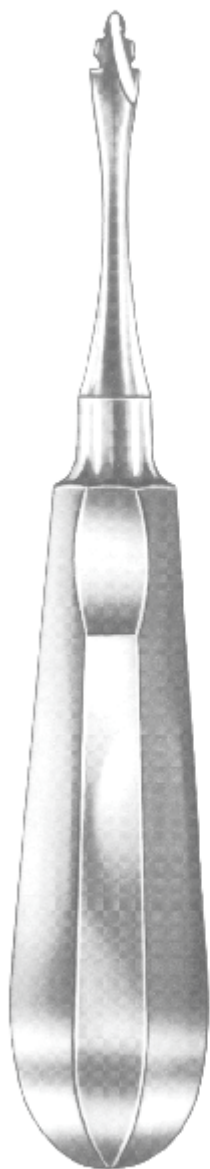

CM-1400



CM-1401

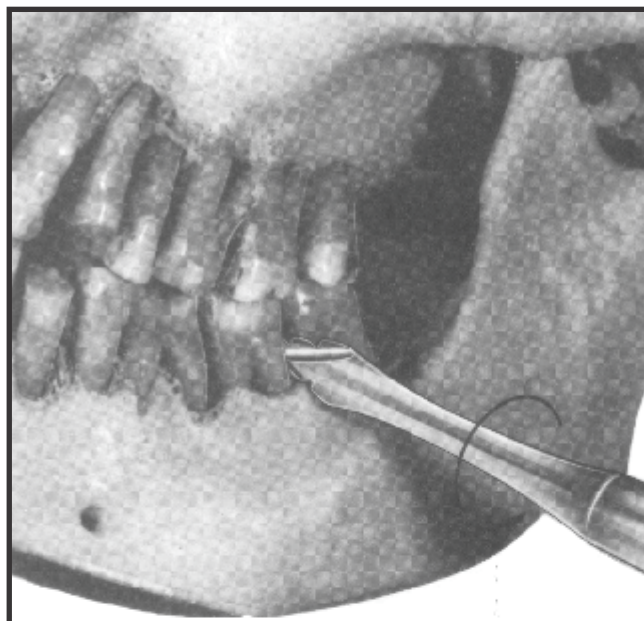

Root elevator, spiral-shaped, for extremely facilitated extraction of the molars in the lower jaw. The slender, conical points allow deep penetration between tooth and gum. Owing to the hook-shaped working parts, slipping of the elevator is avoided.



**Bein
CM-1402
Fig 1**

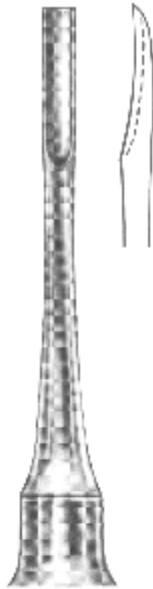

**Bein
CM-1403
Fig 2**



**Bein
CM-1404
Fig 0**

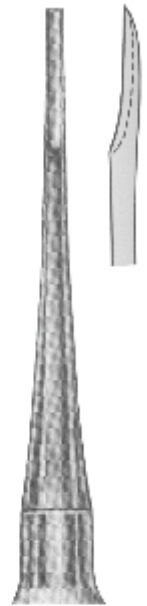

**Bein
CM-1405
Fig 3**

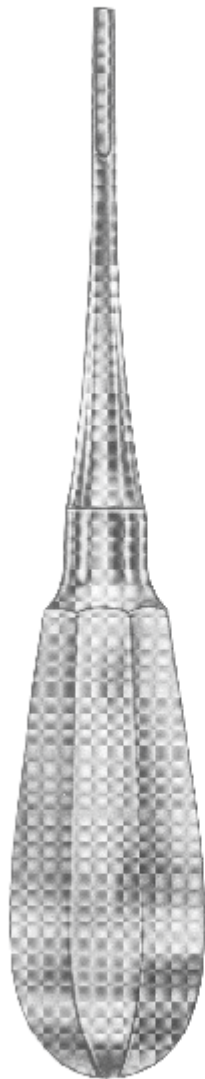

Bein

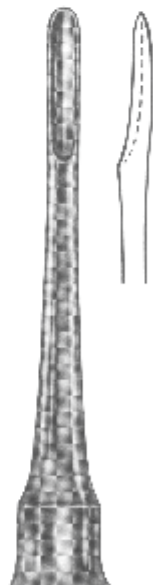

**Bein
CM-1406
Fig 4**

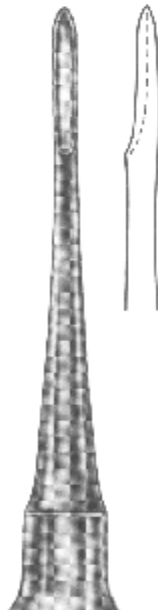

**Bein
CM-1407
Fig 5**

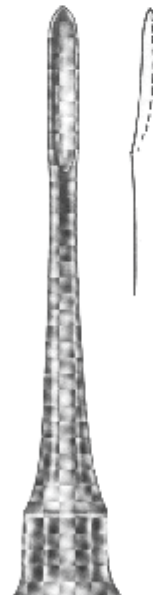

**Bein
CM-1408
Fig 6**



Seldin



Seldin
CM-1409
Fig 1L



Seldin
CM-1410
Fig 1R



Seldin
CM-1411
Fig 2

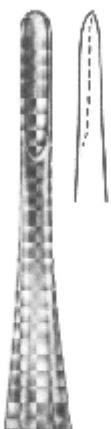

Seldin
CM-1412
Fig 3



Seldin
CM-1413
Fig 4L



Seldin
CM-1414
Fig 4R



**Cryer
CM-1415**
Fig 3



**Cryer
CM-1416**
Fig 4

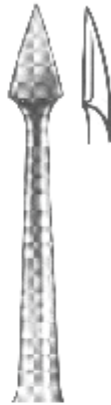

**Cryer
CM-1417**
Fig 12



**Cryer
CM-1418**
Fig 27



**Cryer
CM-1419**
Fig 28



**Cryer
CM-1420**
Fig 27 S



**Cryer
CM-1421**
Fig 28 S



Apical



Apical
CM-1422
Fig 1



Apical
CM-1423
Fig 2



Apical
CM-1424
Fig 3



Apical
CM-1425
Fig 4

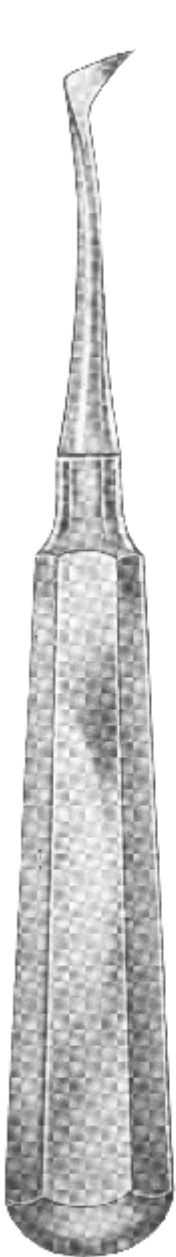

Cryer



Cryer
CM-1426
Fig 1

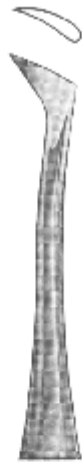

Cryer
CM-1427
Fig 2



Coupland



Coupland
CM-1428
Fig 1



Coupland
CM-1429
Fig 2



Coupland
CM-1430
Fig 3

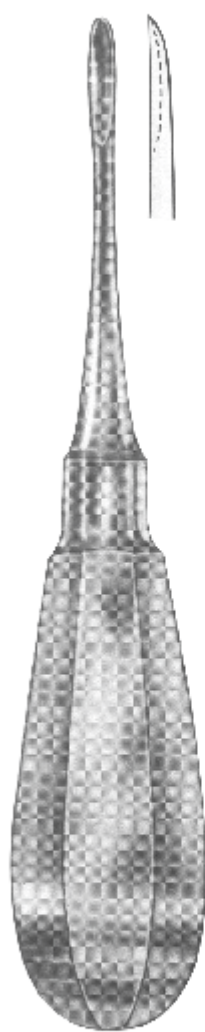

CM-1431
Fig 1

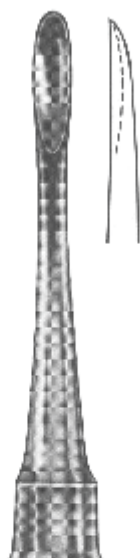

CM-1432
Fig 2

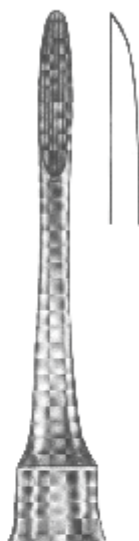

CM-1433
Fig 3



Flohr
CM-1434
Fig 1

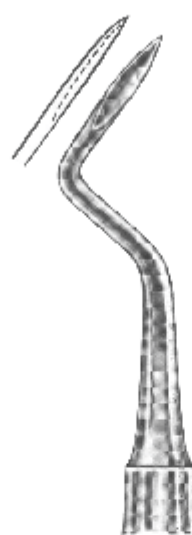

Flohr
CM-1435
Fig 2



Flohr
CM-1436
Fig 3



**Kopp
CM-1437
Fig 1**



**Kopp
CM-1438
Fig 2**



**Kopp
CM-1443
Fig 1**



**Kopp
CM-1444
Fig 2**

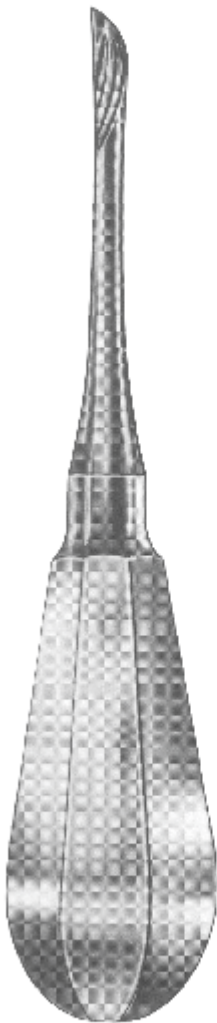

Kopp



**Kopp
CM-1439
Fig 3**



**Kopp
CM-1440
Fig 4**



Kopp



**Kopp
CM-1445
Fig 3**



**Kopp
CM-1446
Fig 4**



**Kopp
CM-1441
Fig 5**



**Kopp
CM-1442
Fig 6**

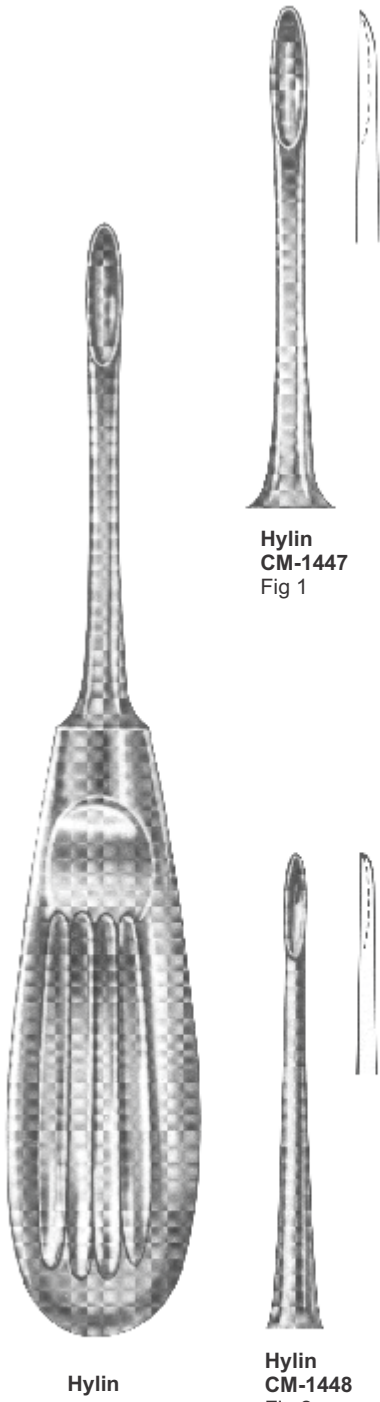

Hylin
CM-1447
Fig 1

Hylin
CM-1448
Fig 2



Bein
CM-1449
Fig 1

Bein
CM-1451
Fig 3

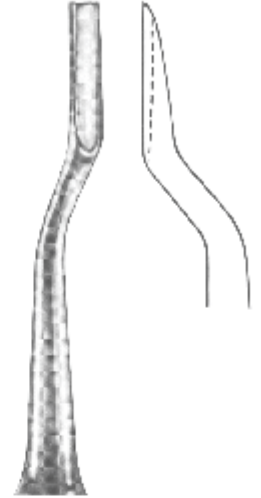
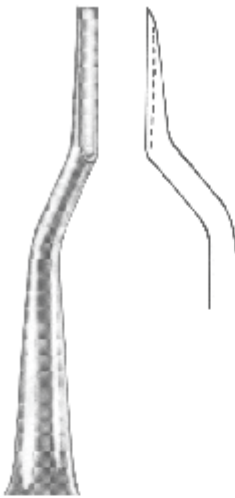

Bein
CM-1450
Fig 2

Bein
CM-1452
Fig 4

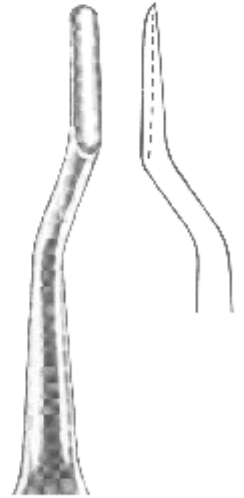
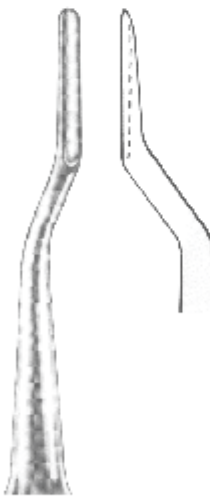



Warwick-James
CM-1453
Fig 1

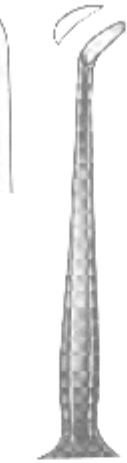

Warwick-James
CM-1454
Fig 2



Warwick-James
CM-1455
Fig 3

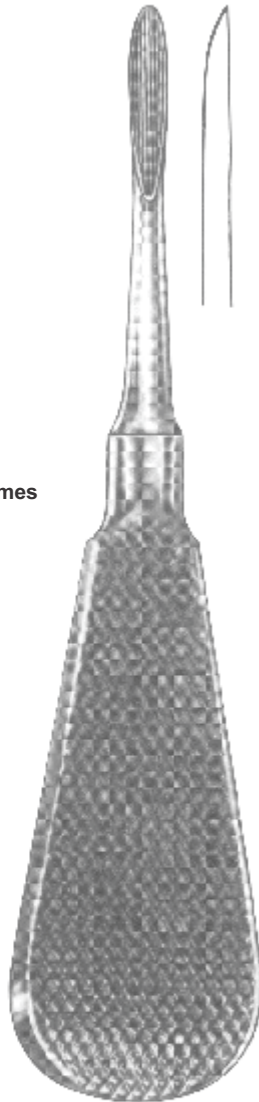

London Hospital
CM-1456
Fig 1



London Hospital
CM-1457
Fig 2



London Hospital
CM-1458
Fig 3

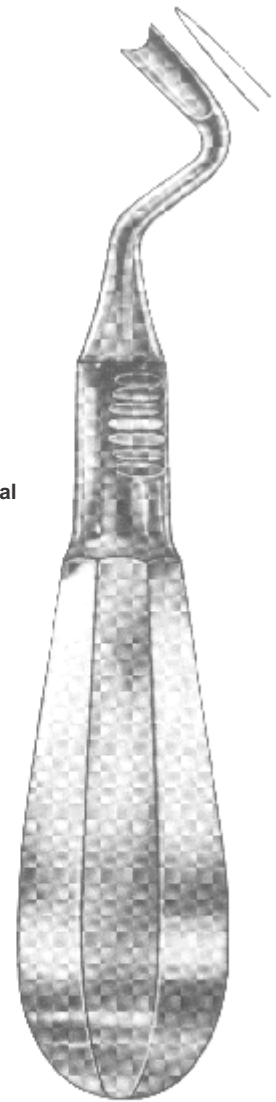

Ott
CM-1459

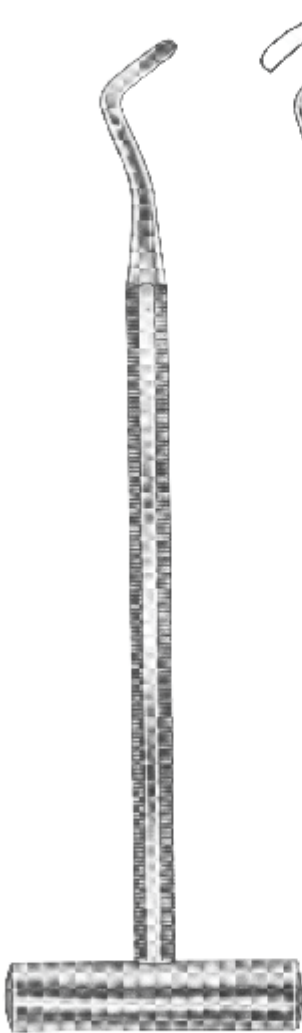

Pott

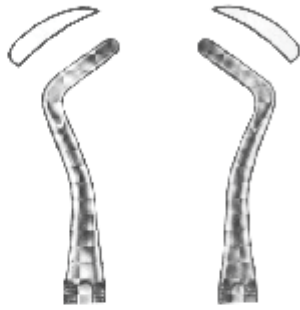

Pott
1CM-1460
Fig 1

Pott
CM-1461
Fig 2



CM-1462
Fig 1

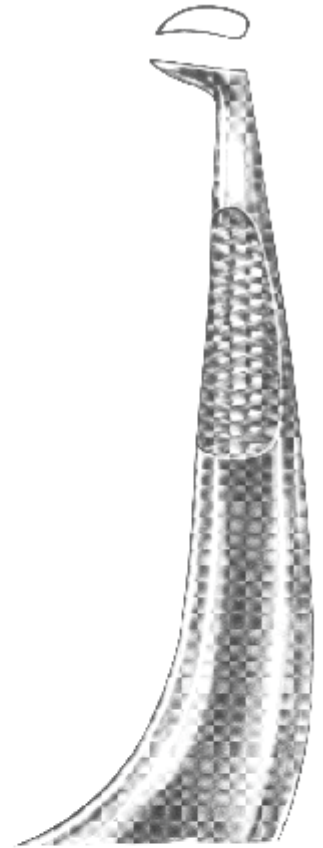

CM-1463
Fig 2

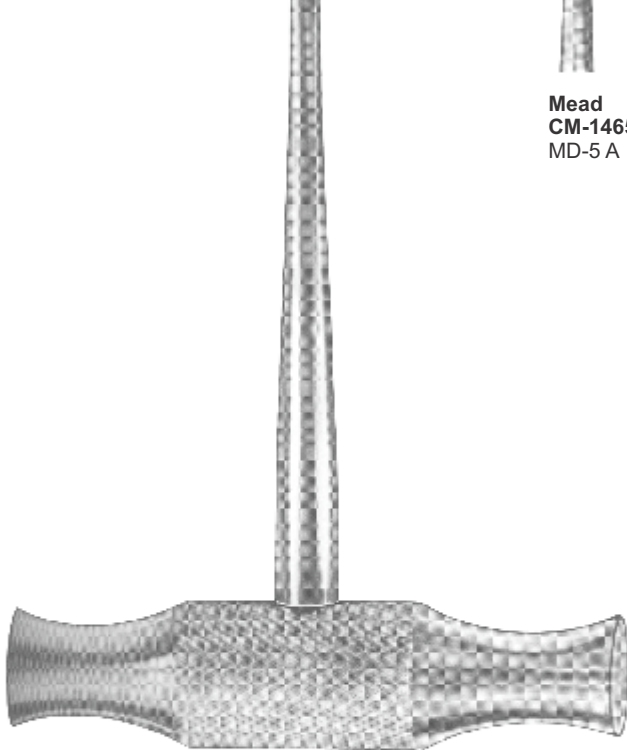
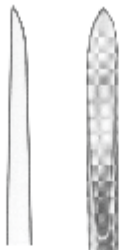

Mead
CM-1464
MD 1



Mead
CM-1465
MD-5 A



Mead
CM-1466
MD-6 A



Mead
CM-1467
MD-7 A



Mead
CM-1468
MD-8

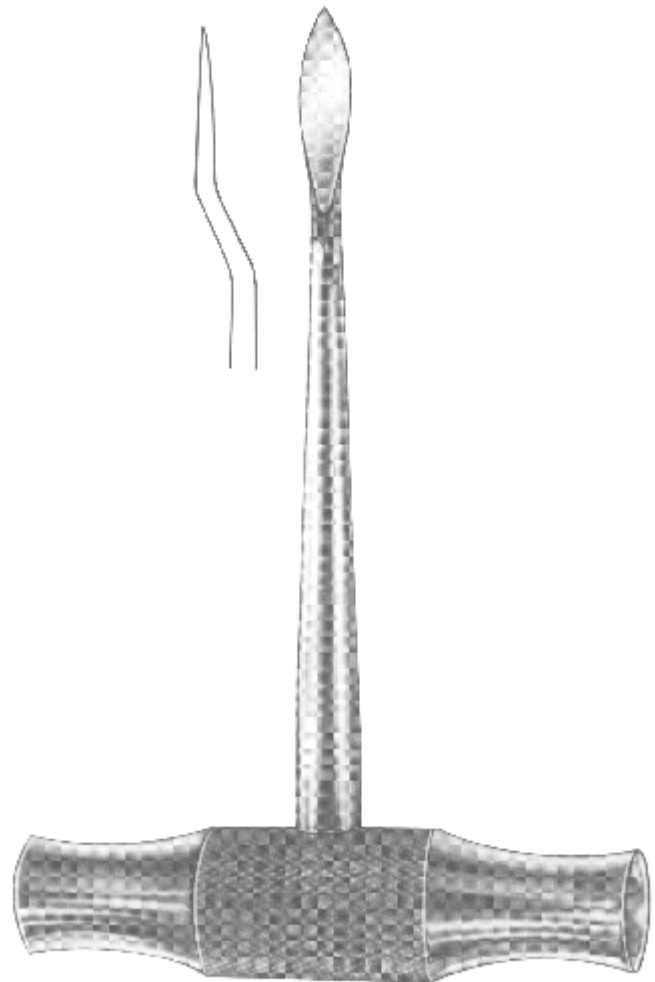

Lecluse
CM-1469



**Chompret
CM-1470**
Fig 1



**Chompret
CM-1471**
Fig 2



**Chompret
CM-1472**
Fig 3



**Chompret
CM-1473**
Fig 4

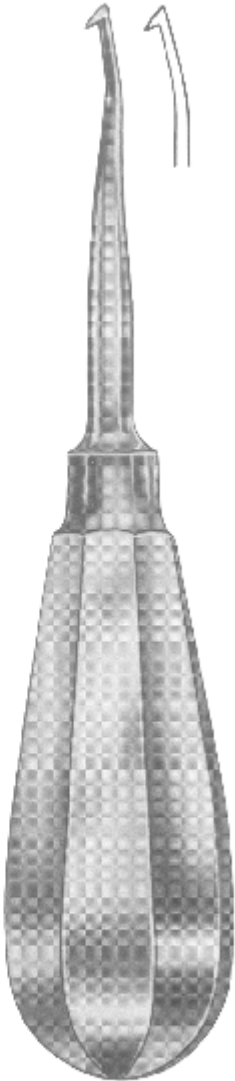

**Apical
CM-1474**



CM-1475
Fig 1



CM-1476
Fig 2



CM-1477
Fig 3



**Heidbrink
CM-1478**
Fig 1



**Heidbrink
CM-1479**
Fig 2



**Heidbrink
CM-1480**
Fig 3



Winter
CM-1481
Fig 1L



Winter
CM-1482
Fig 1R

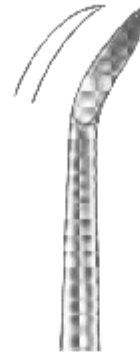

Winter
CM-1483
Fig 2L



Winter
CM-1484
Fig 2R

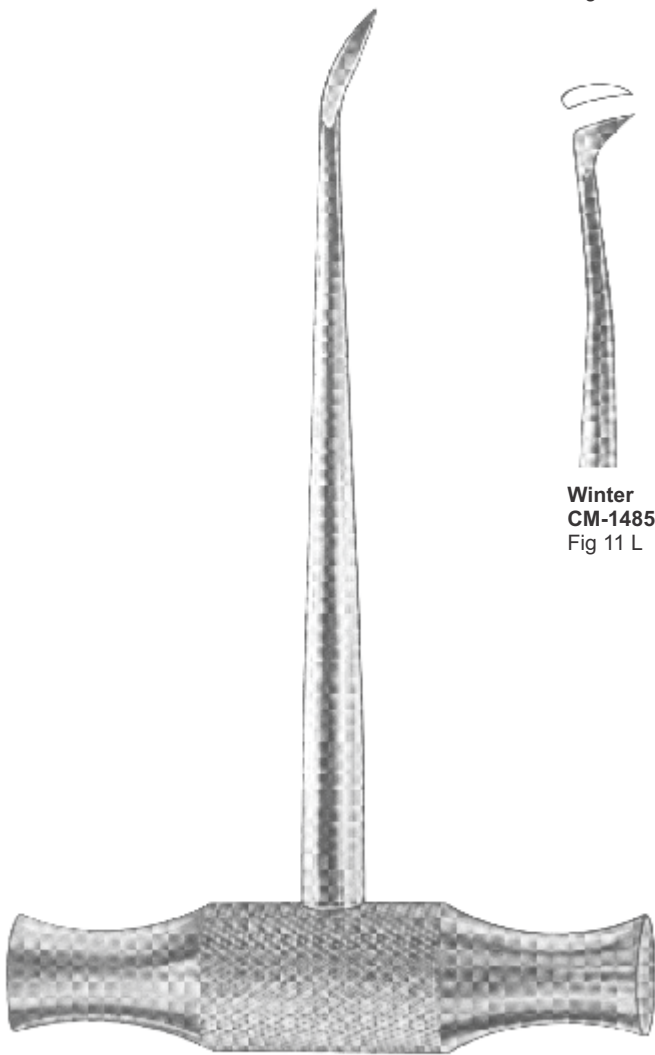

Winter



Winter
CM-1485
Fig 11 L



Winter
CM-1486
Fig 11 R



Winter
CM-1487
Fig 12 L



Winter
CM-1488
Fig 12 R



Winter
CM-1489
Fig 14 L



Winter
CM-1490
Fig 14 R



Barry
CM-1491
Fig 1



Barry
CM-1492
Fig 2



Barry
CM-1493
Fig 3



Barry
CM-1494
Fig 4



Barry



Barry
CM-1495
Fig 11



Barry
CM-1496
Fig 12



Barry
CM-1497
Fig 17



Barry
CM-1498
Fig 18



Cryer
CM-1500
Fig 26



Seldin
CM-1501
Fig 27

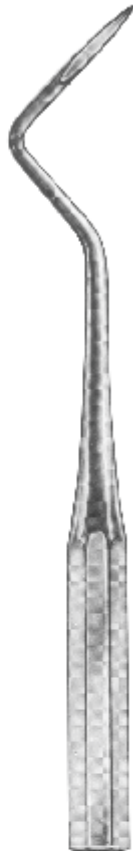

Cryer
CM-1502
Fig 28



Cryer
CM-1503
Fig 29



Heidbrink
CM-1504
Fig 22



Heidbrink
CM-1505
Fig 23

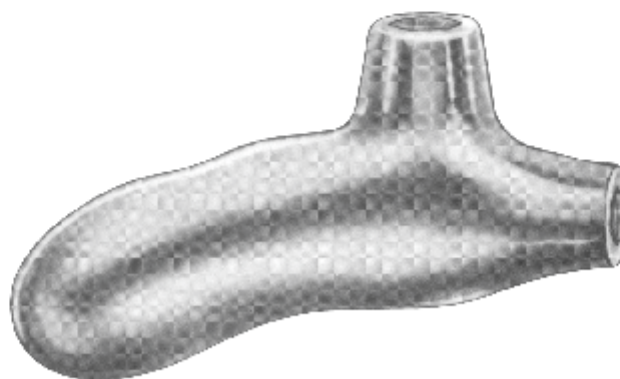

CM-1499



**Kopp
CM-1507**
Fig 31



**Kopp
CM-1508**
Fig 32



**Kopp
CM-1509**
Fig 33



**Kopp
CM-1510**
Fig 34

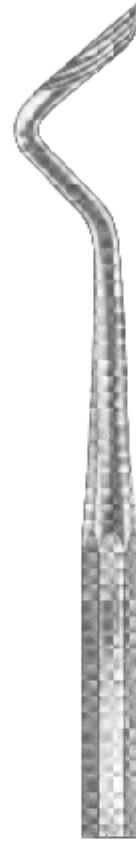

**Kopp
CM-1511**
Fig 35



**Kopp
CM-1512**
Fig 44

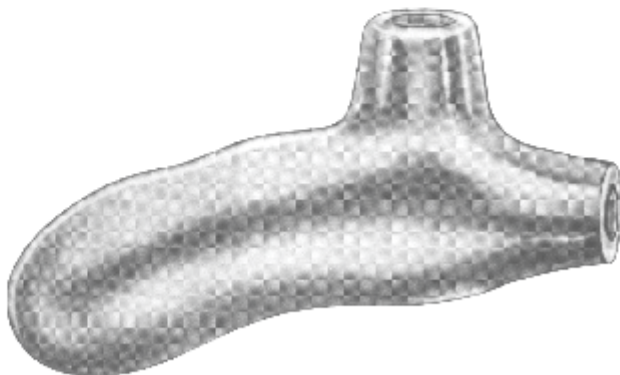

CM-1506



**Heidbrink
CM-1514
Fig 10**



**Winter
CM-1515
Fig 11**



**Winter
CM-1516
Fig 12**



**Barry
CM-1517
Fig 17**

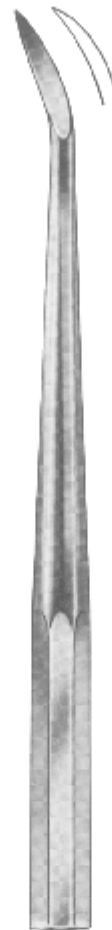

**Barry
CM-1518
Fig 18**



**CM-1519
Fig 20**

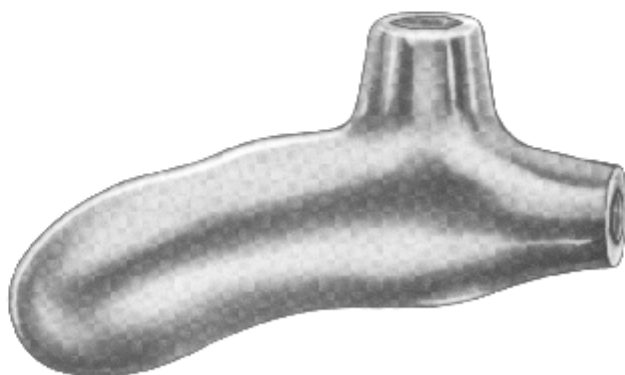

CM-1513

Root Elevators according to Dr. Sader,
with interchangeable working tips



CM-1521

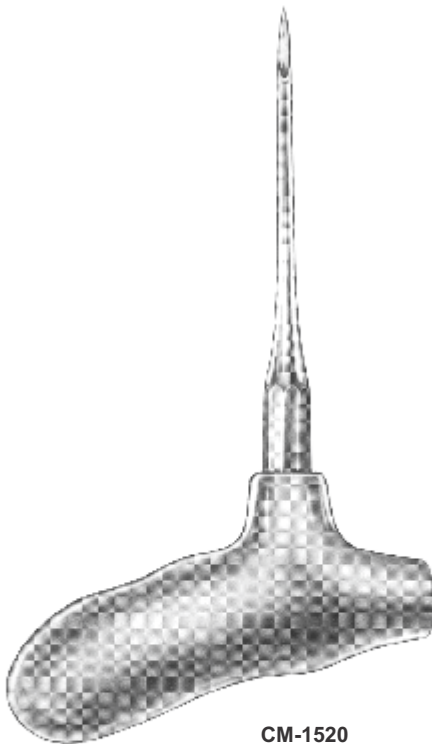

CM-1520

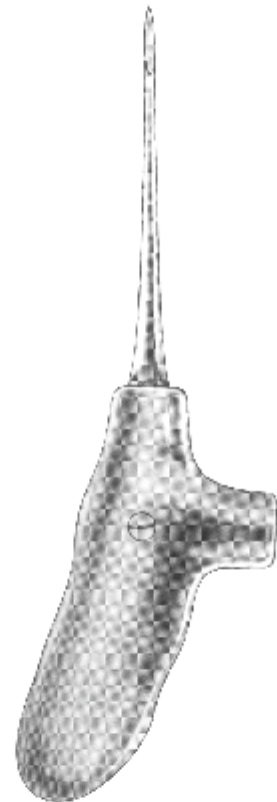

CM-1522



CM-1523
Root Elevators Kit (8 Pieces)

Contents:-

- CM-1524** Cryer Medium Fig. 44
- CM-1525** Cryer Medium Fig. 45
- CM-1526** Apical 3mm Fig. 4
- CM-1527** Apical 3mm Fig. 5
- CM-1528** Flohr 3mm Fig. 1F
- CM-1529** Root Elevator Straight 2mm
- CM-1530** Root Elevator Straight 3mm
- CM-1531** Root Elevator Straight 4mm



CM-1532
Root Elevators Set (5 Pieces)

Contents:-

- CM-1533** Apical 3mm Fig. 4
- CM-1534** Apical 3mm Fig. 5
- CM-1535** Root Elevator Straight 3mm
- CM-1536** Winter Fig. 12L
- CM-1537** Winter Fig. 12R



CM-1538
Root Elevators Set (11 Pieces)

Contents:-

- CM-1539** Apical 3mm Fig. 4
- CM-1540** Apical 3mm Fig. 5
- CM-1541** Apexo 3mm
- CM-1542** Root Elevator Straight 2mm
- CM-1543** Root Elevator Straight 3mm
- CM-1544** Root Elevator Straight 4mm
- CM-1545** Cryer Medium Fig. 44
- CM-1546** Cryer Medium Fig. 45
- CM-1547** Flohr 3mm Fig. 1F
- CM-1548** Root Elevator Curved 3mm
- CM-1549** Splinter Forcep Angled 14.5cm



CM-1550
Luxator Kit of (8 Pieces)

Contents:-

- | | |
|-------------------------|-----------------------|
| CM-1551 Straight | CM-1555 Curved |
| CM-1552 Straight | CM-1556 Curved |
| CM-1553 Straight | CM-1557 Curved |
| CM-1554 Straight | CM-1558 Curved |



CARE MEDICAL[®]
SUPPLIES

Your health _ Our Priority

Section

03

Page 60-106

Peridontia Instruments



inspiring
confidence in
health
care

www.caremedical.com.pk

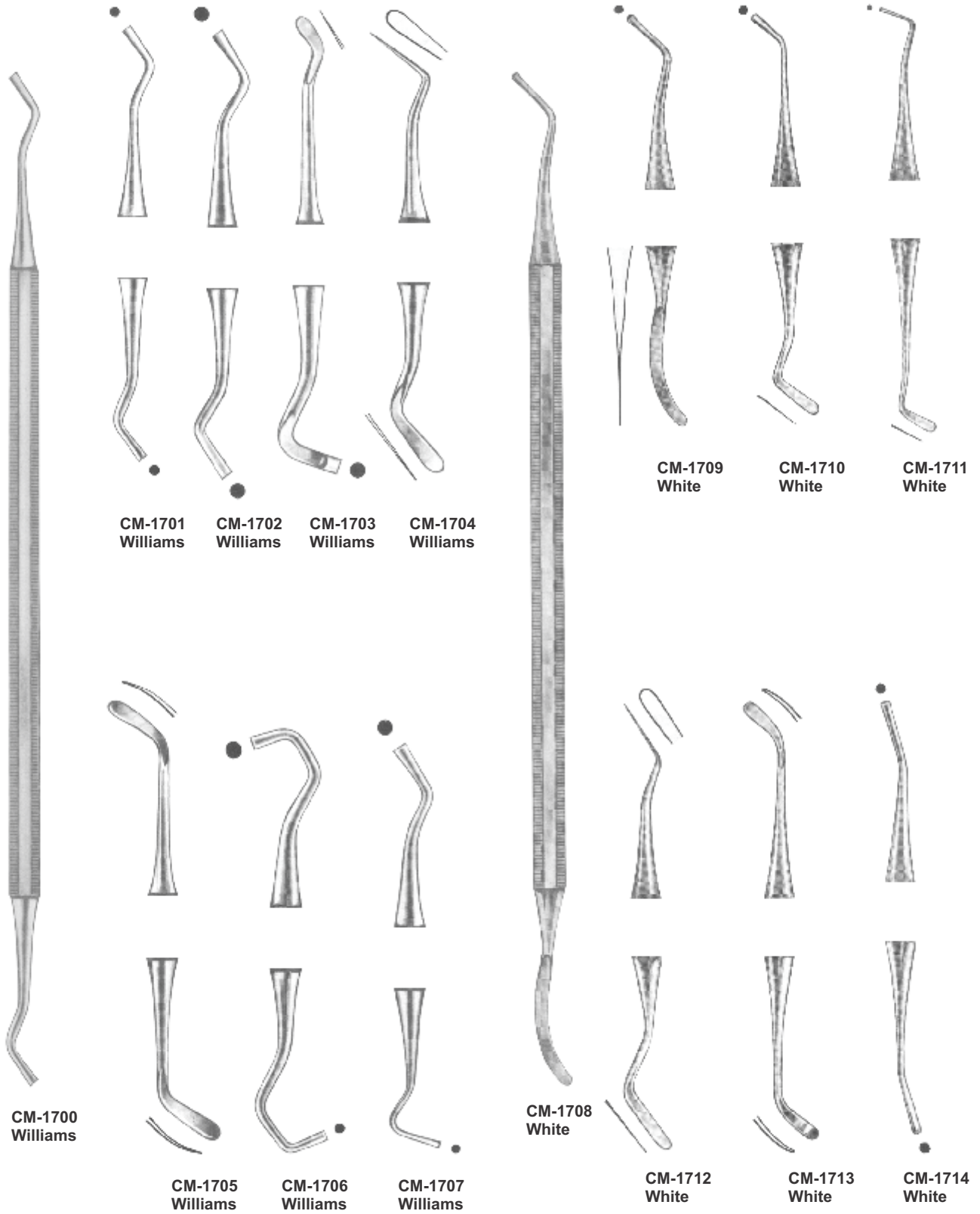

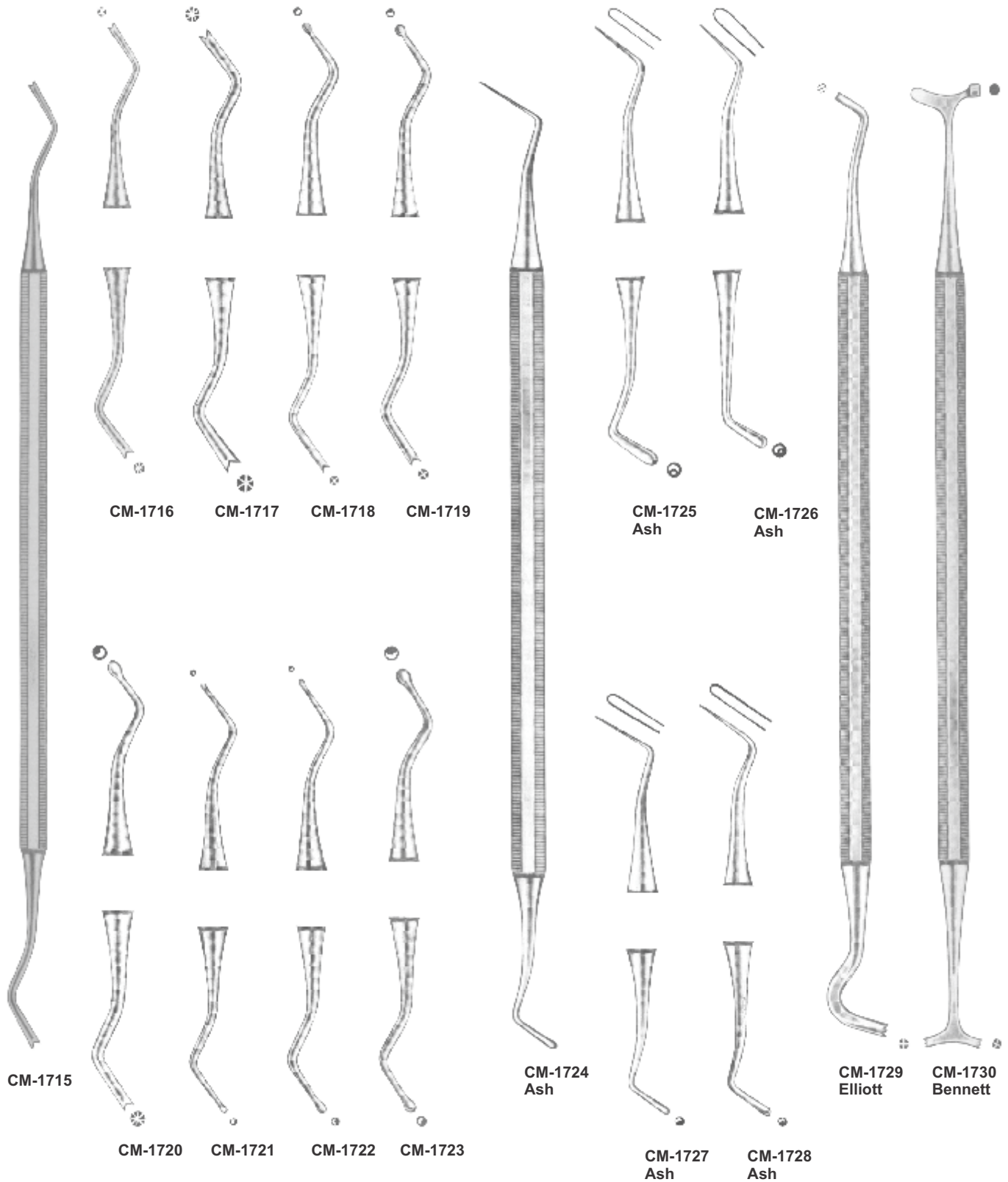

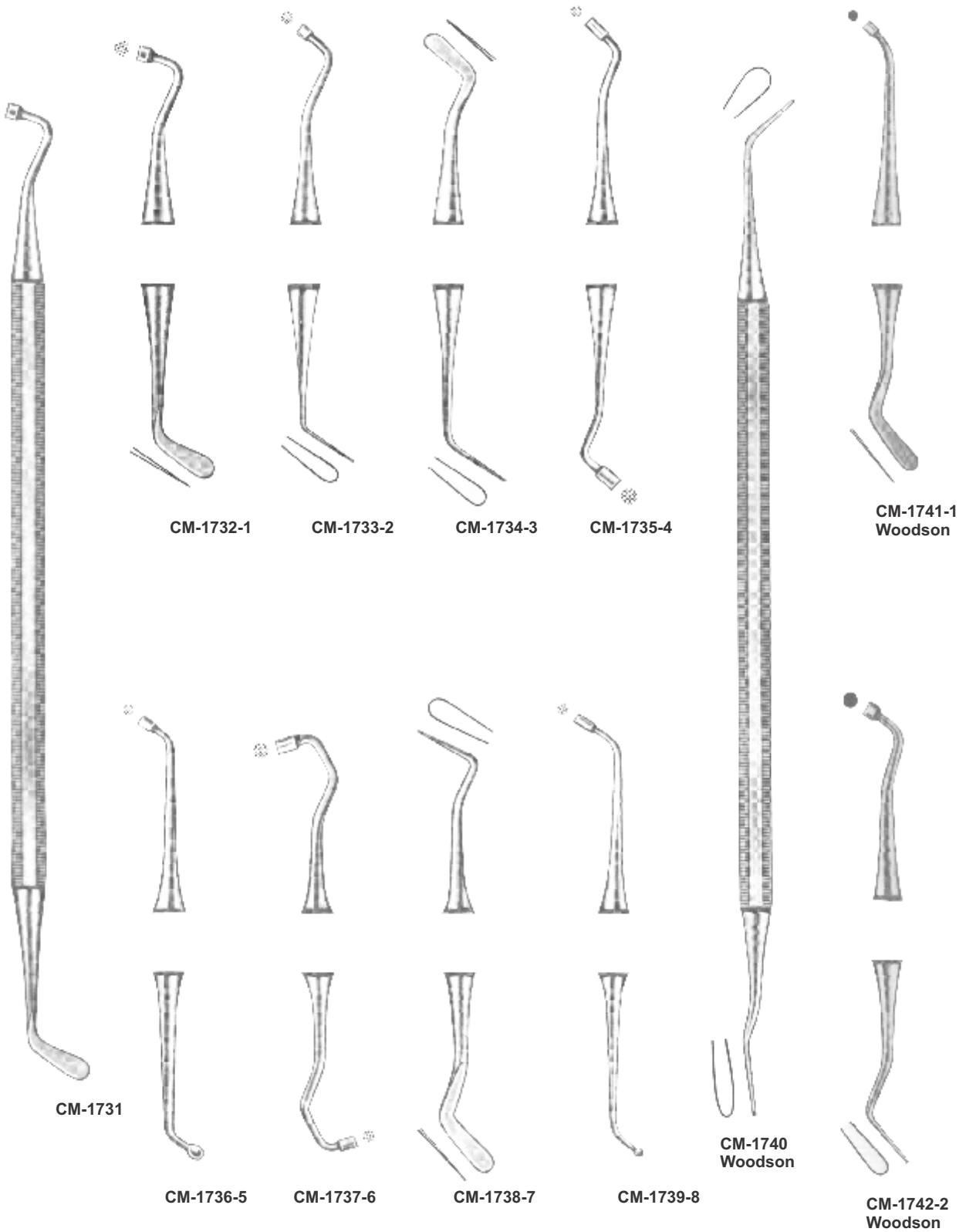



CM-1743
Heidemann
Fig 1



CM-1744
Heidemann
Fig 2



CM-1745
Heidemann
Fig 3



CM-1746



CM-1747
Fig 146



CM-1749
Fig 148



CM-1748
Fig 147



CM-1750
Fig 149



CM-1751
Fig 158

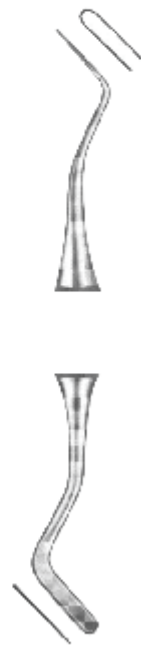

CM-1752
Fig 159



CM-1753
Woodson
Fig 160



CM-1754
Gracey



CM-1755
Gracey
Fig 1



CM-1756
Gracey
Fig 2



CM-1757
Gracey
Fig 3

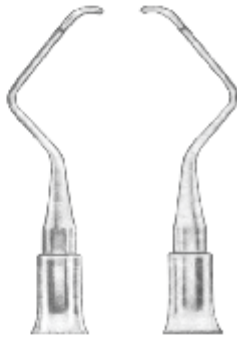

CM-1758
Gracey
Fig 4



CM-1759
Gracey
Fig 5



CM-1760
Gracey
Fig 6



CM-1761



CM-1762-1
Fig 18



CM-1763-2
Fig 19



CM-1764-3
Fig 20



CM-1765-4
Fig 22



CM-1766-5
Fig 23



CM-1767-6
Fig 25



CM-1768-7
Fig 26



CM-1769-8
Fig 27

With Point Set In



CM-1770



CM-1771-1



CM-1772-2



CM-1773-3



CM-1774-4



CM-1775-5



CM-1776-6



CM-1777-7



CM-1778-8



CM-1779-9



CM-1780-10



CM-1781-11



CM-1782-2
Woodson

Polishing Instruments

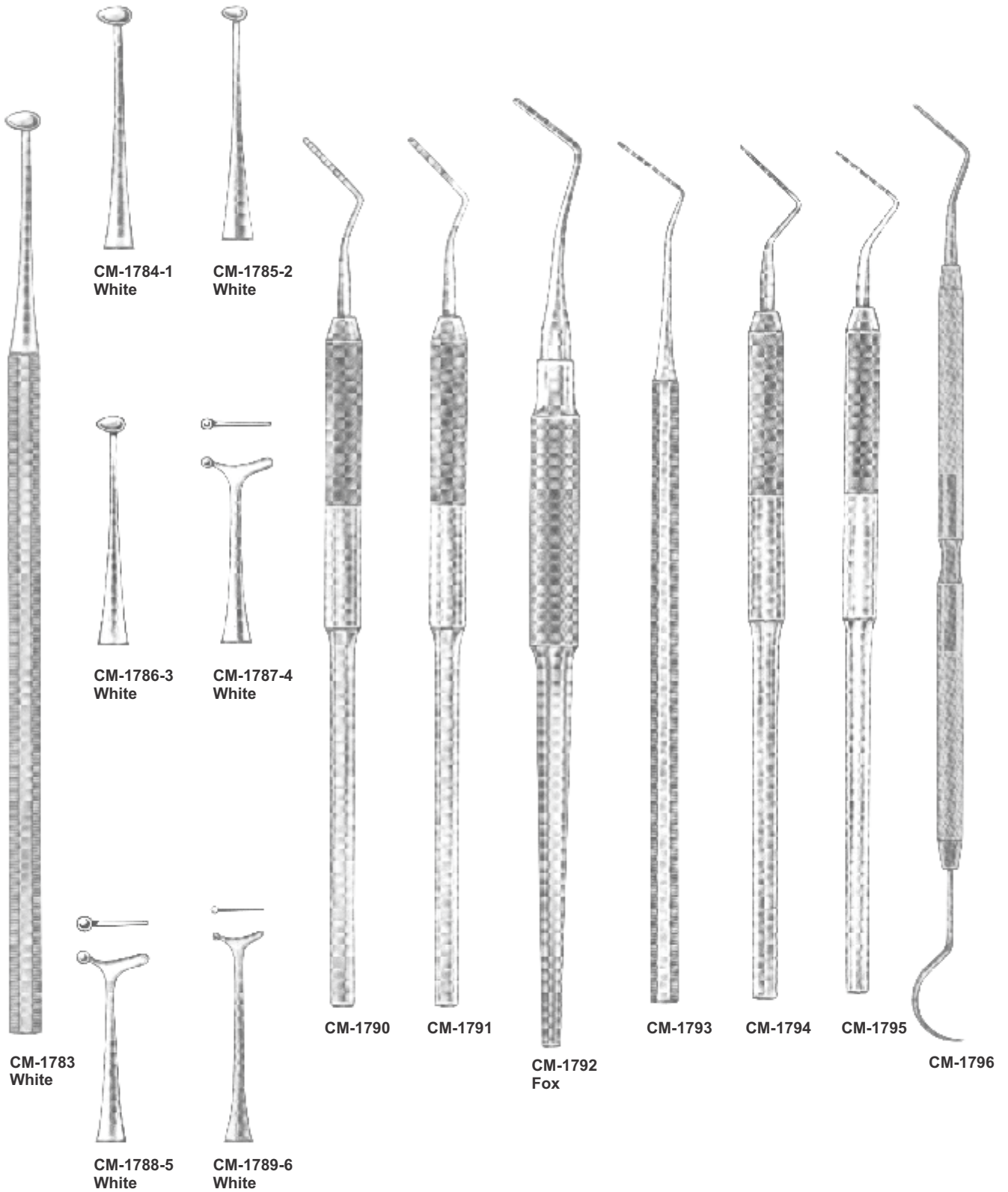

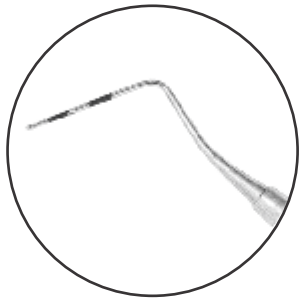

- New marking process.
- Laser system marking.
- No more paint peeling off.
- Permanent marking.
- Antiglare, low depth marking.
- Maximum tip resistance against breaking.



CM-1797
Fig CP-C



CM-1798
Fig CP-11



CM-1799
Fig CP-12



CM-1800
Fig CP-12S
O.M.S



CM-1801
Williams



CM-1802
Merrit A



CM-1803
Merrit B



CM-1804
Goldman
Fox



CM-1805
University of
Michigan



CM-1806
26 G

Files

Chisels

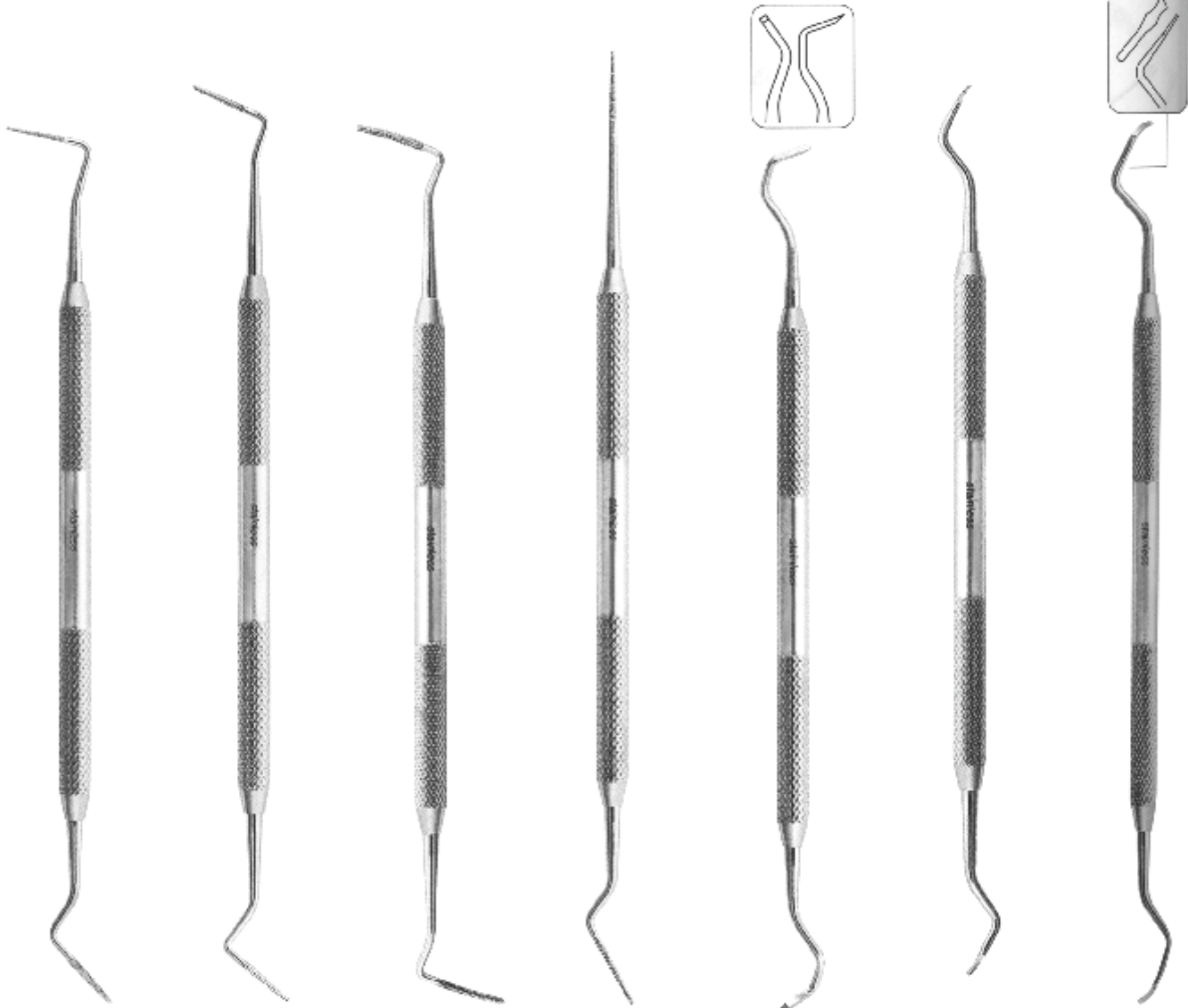

CM-1807
Sugarman
Fig. 1S/2S

CM-1808
Sugarman
Fig. 3S/4S

CM-1809
Schluger
Fig. 9/10

CM-1810
Buck
Fig. 11/12

CM-1811
Ochsenbein
Fig. 3

CM-1812
Ochsenbein
Fig. 4

CM-1813
Rhodes
Back - Action
Fig. 36/37

Files

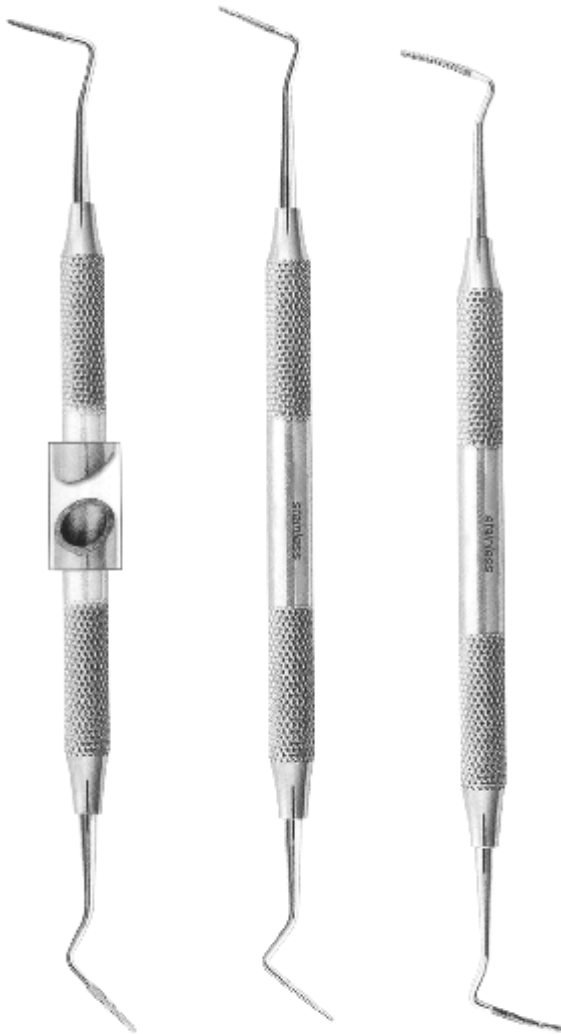

CM-1814
Sugarman
Fig. 1S/2S



CM-1815
Sugarman
Fig. 3S/4S



CM-1816
Schluger
Fig. 9/10



CM-1817
Buck
Fig. 11/12



Chisels



CM-1818
Ochsenbein
Fig. 3



CM-1819
Ochsenbein
Fig. 4



CM-1820
Rhodes
Back - Action
Fig. 36/37

Gingivectomy knives



CM-1821
Goldman-Fox
Fig. 7



CM-1822
Goldman-Fox
Fig. 8



CM-1823
Goldman-Fox
Fig. 9



CM-1824
Goldman-Fox
Fig. 11



CM-1825
Buck
Fig. 3/4



CM-1826
Buck
Fig. 5/6

Curettes and Scalers



CM-1827
Curette
Fig. HU 1/2



CM-1828
Columbia
Fig. 2R/2L



CM-1829
Columbia
Fig. 4R/4L



CM-1830
Columbia
Fig. 13/14



CM-1831
Fig. 411/412



CM-1832
Fig. 413/414



CM-1833
Zerfing-chisel

Gingivectomy knives

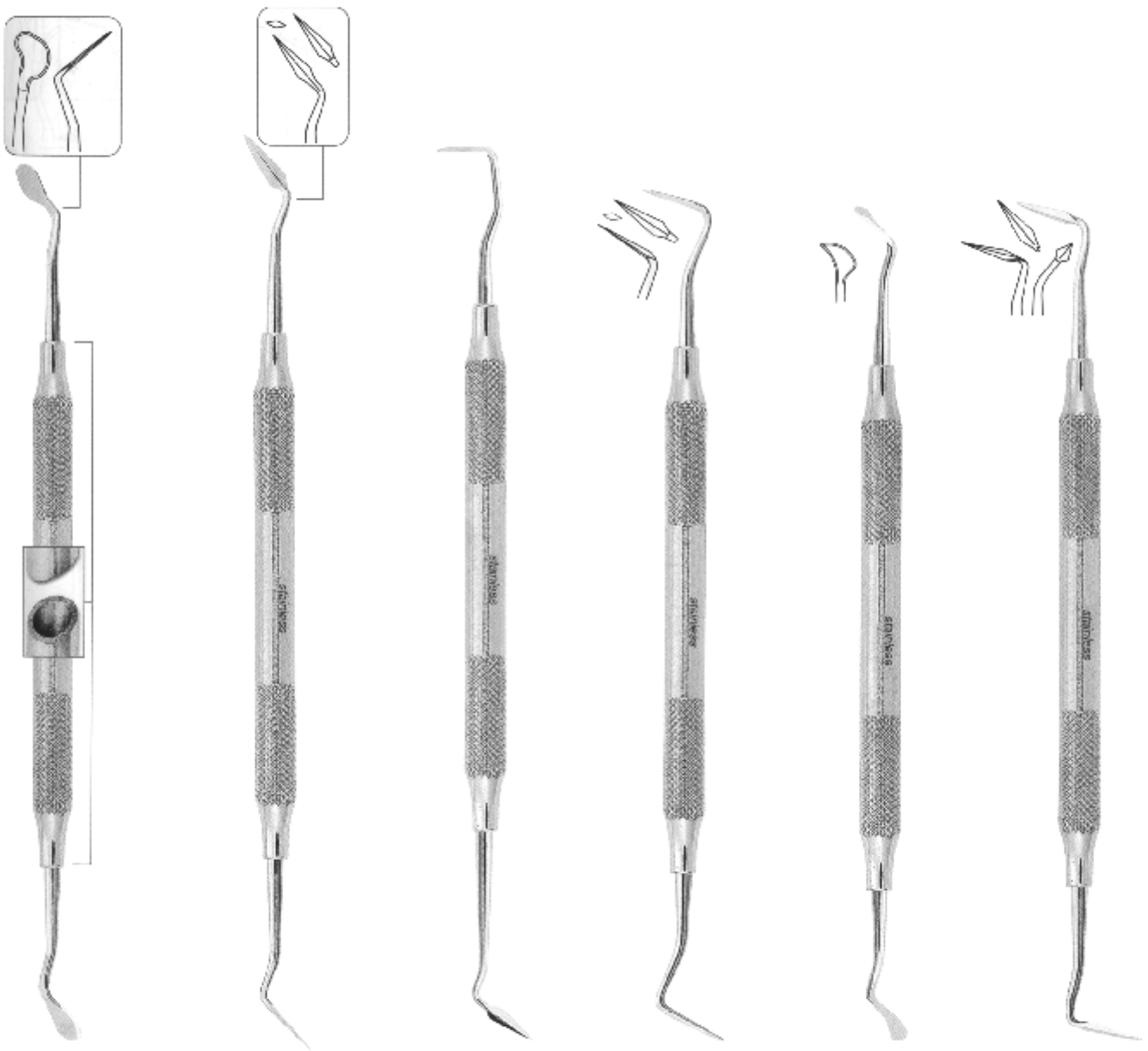

CM-1834
Goldman - Fox
Fig. 7

CM-1835
Goldman - Fox
Fig. 8

CM-1836
Goldman - Fox
Fig. 9

CM-1837
Goldman - Fox
Fig. 11

CM-1838
Buck
Fig. 3/4

CM-1839
Buck
Fig. 5/6

Curettes and Scalers



CM-1840
Curette
Fig. HU 1/2



CM-1841
Columbia
Fig. 2R/2L



CM-1842
Columbia
Fig. 4R/4L



CM-1843
Columbia
Fig. 13/14



CM-1844
Fig. 413/412



CM-1845
Fig. 411/414



CM-1846
Zerfing-chisel

Bone Chisels and Gouges

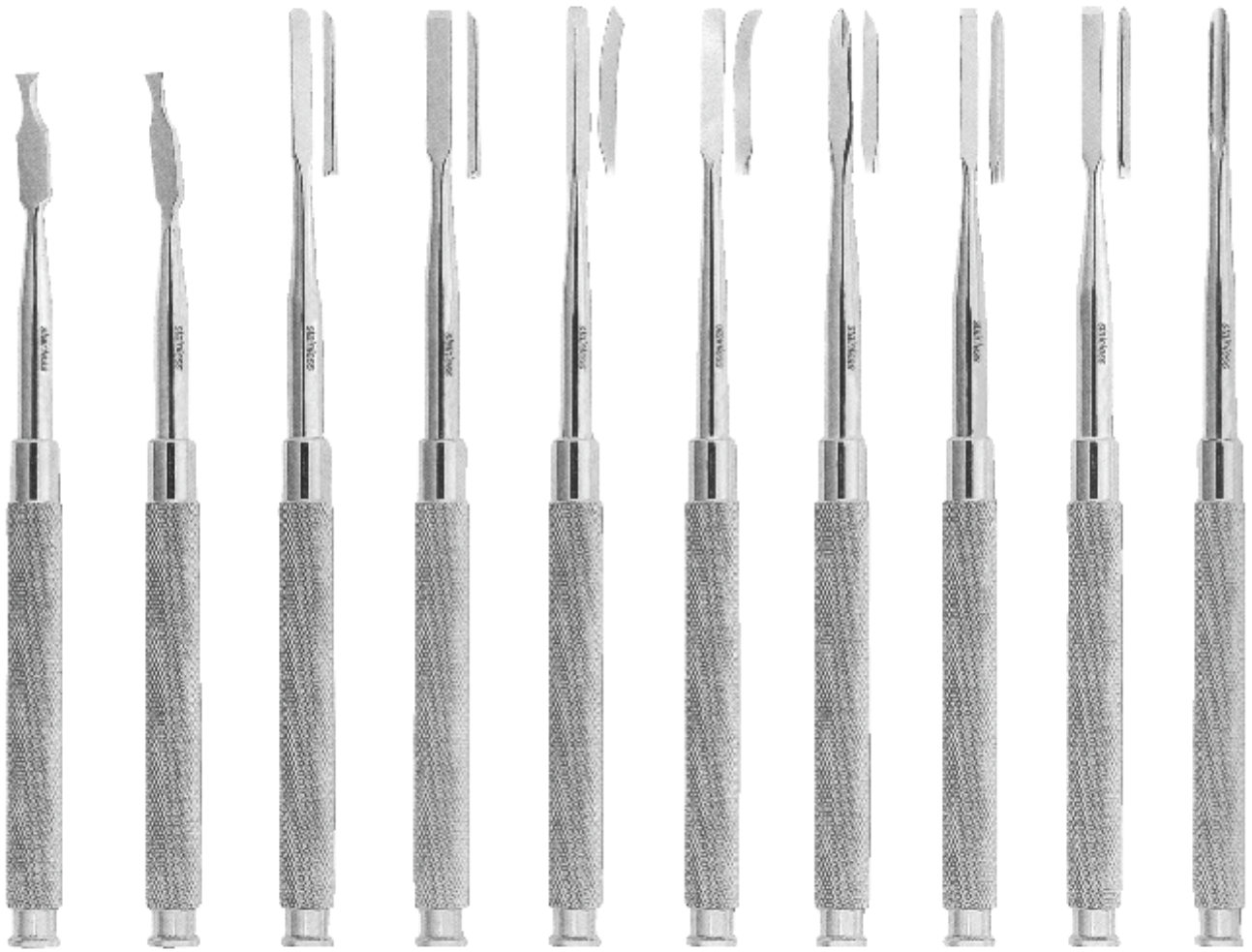

CM-1847 Ochsenbein Fig. 1	CM-1848 Ochsenbein Fig. 2	CM-1849 Gardner Fig. 1	CM-1850 Gardner Fig. 2	CM-1851 Gardner Fig. 5	CM-1852 Gardner Fig. 5R	CM-1853 Gardner Fig. 6	CM-1854 Wakefield Fig. 1W	CM-1855 Wakefield Fig. 2W	CM-1856 Buckley Fig. 3
--	--	-------------------------------------	-------------------------------------	-------------------------------------	--------------------------------------	-------------------------------------	--	--	-------------------------------------

Bone Chisels and Gouges

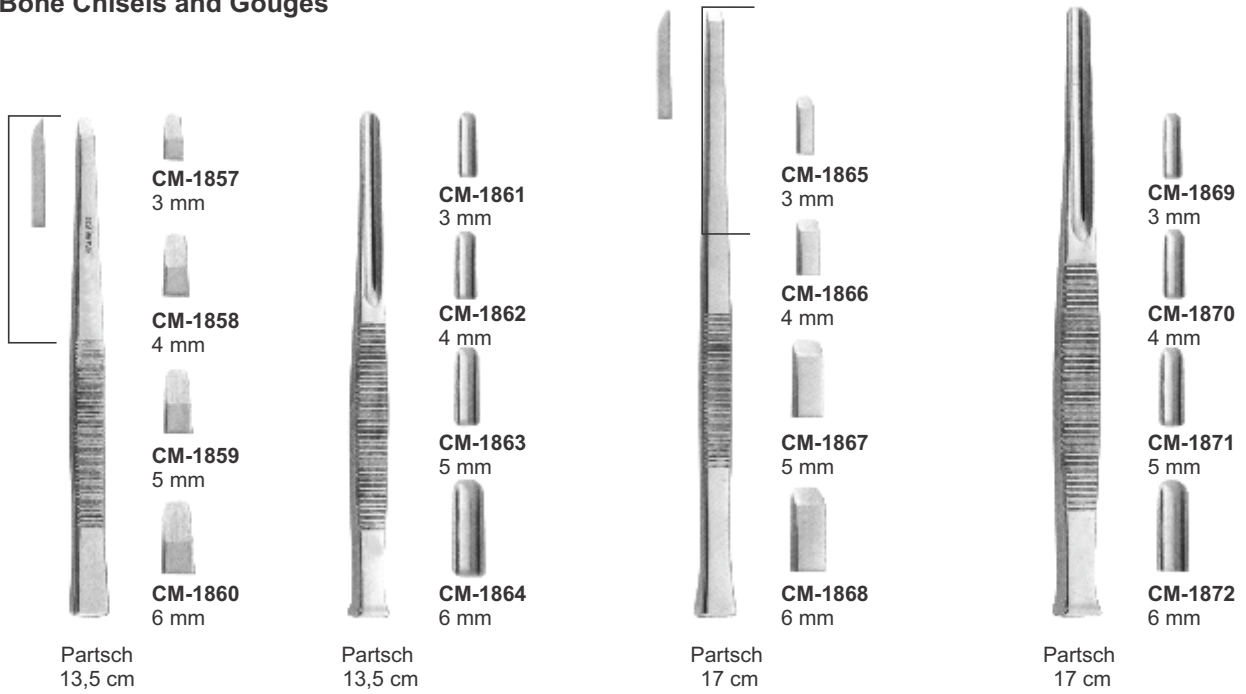

Martelli chirurgici
Mallet

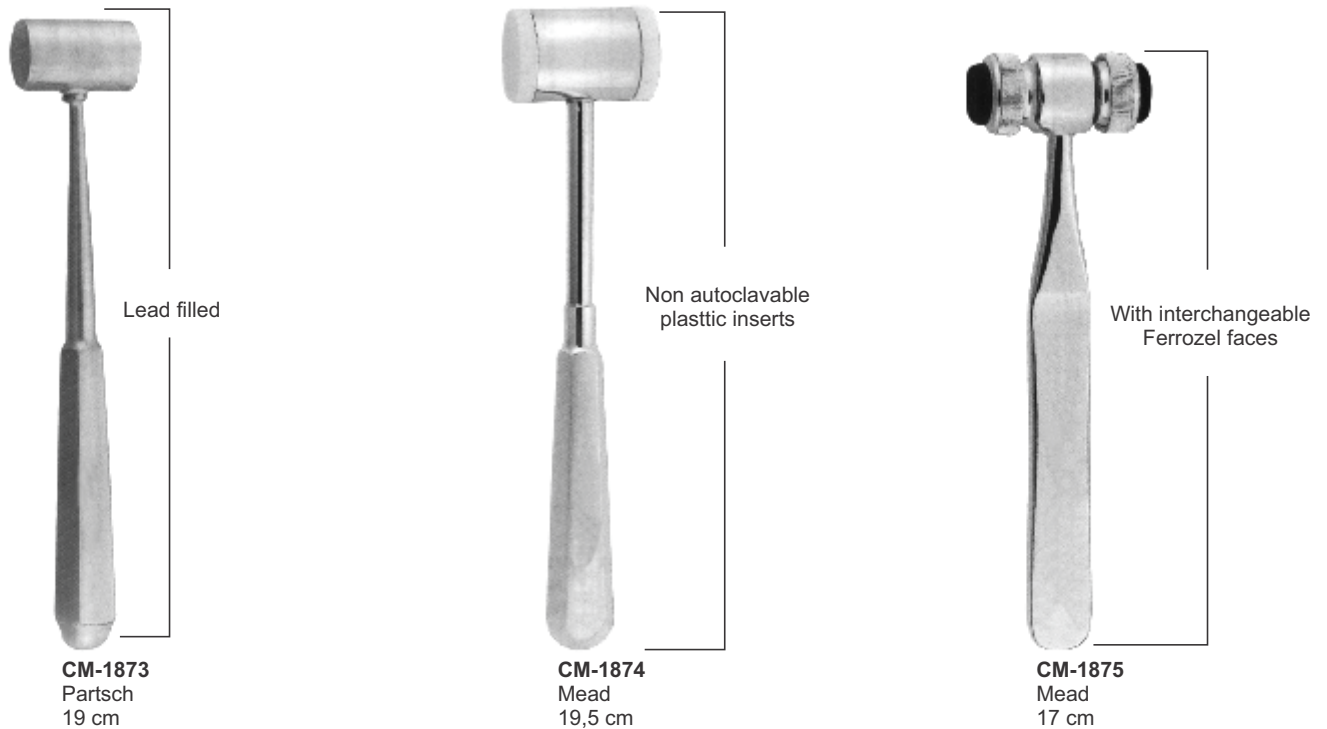

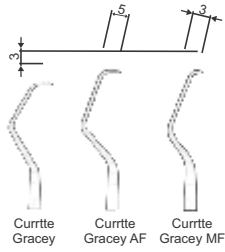

CM-1876
Gracey
Fig. 1/2



CM-1877
Gracey
Fig. 3/4



CM-1878
Gracey
Fig. 5/6



CM-1879
Gracey
Fig. 7/8



CM-1880
Gracey
Fig. 9/10



CM-1881
Gracey
Fig. 11/12



CM-1882
Gracey
Fig. 13/14



CM-1883
Gracey
Mesial Distal
Fig. 11/14



CM-1884
Gracey
Mesial Distal
Fig. 12/13

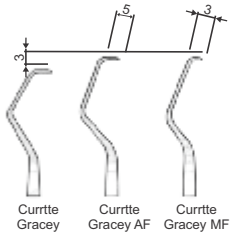

CM-1885
Gracey
AF/type
Fig. 1/2



CM-1886
Gracey
AF/type
Fig. 3/4



CM-1887
Gracey
AF/type
Fig. 5/6



CM-1888
Gracey
AF/type
Fig. 7/8



CM-1889
Gracey
AF/type
Fig. 11/12



CM-1890
Gracey
AF/type
Fig. 13/14



CM-1891
Gracey
AF/type
Fig. 17/16



CM-1892
Gracey
AF/type



CM-1893
Gracey
AF/type
Fig. 1/2



CM-1894
Gracey
AF/type
Fig. 3/4



CM-1895
Gracey
AF/type
Fig. 5/6



CM-1896
Gracey
AF/type
Fig. 7/8



CM-1897
Gracey
AF/type
Fig. 11/12



CM-1898
Gracey
AF/type
Fig. 13/14



CM-1899
Gracey
AF/type
Fig. 15/16



CM-1900
Gracey
MF/type
Fig. 1/2



CM-1901
Gracey
MF/type
Fig. 3/4



CM-1902
Gracey
MF/type
Fig. 5/6



CM-1903
Gracey
MF/type
Fig. 7/8



CM-1904
Gracey
MF/type
Fig. 11/12



CM-1905
Gracey
MF/type
Fig. 13/14



CM-1906
Gracey
MF/type
Fig. 15/16

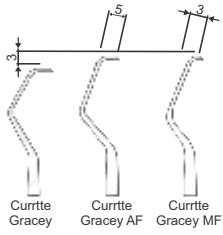

CM-1907
Gracey
MF/type
Fig. 1/2



CM-1908
Gracey
MF/type
Fig. 3/4



CM-1909
Gracey
MF/type
Fig. 5/6



CM-1910
Gracey
MF/type
Fig. 7/8



CM-1911
Gracey
MF/type
Fig. 11/12



CM-1912
Gracey
MF/type
Fig. 13/14



CM-1913
Gracey
MF/type
Fig. 15/16



CM-1914
Goldman - Fax
Fig. 1



CM-1915
Goldman - Fax
Fig. 2

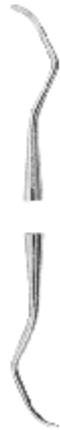

CM-1916
Goldman - Fax
Fig. 3



CM-1917
Goldman - Fax
Fig. 4



CM-1918
Goldman - Fax
Fig. 21

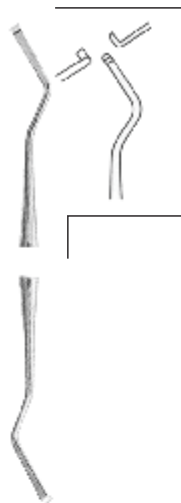

CM-1919
Goldman - Fax
Fig. 5



CM-1920
Mc Call
Fig. 13S/14S

CM-1921
Younger-Good
Fig. 7/8

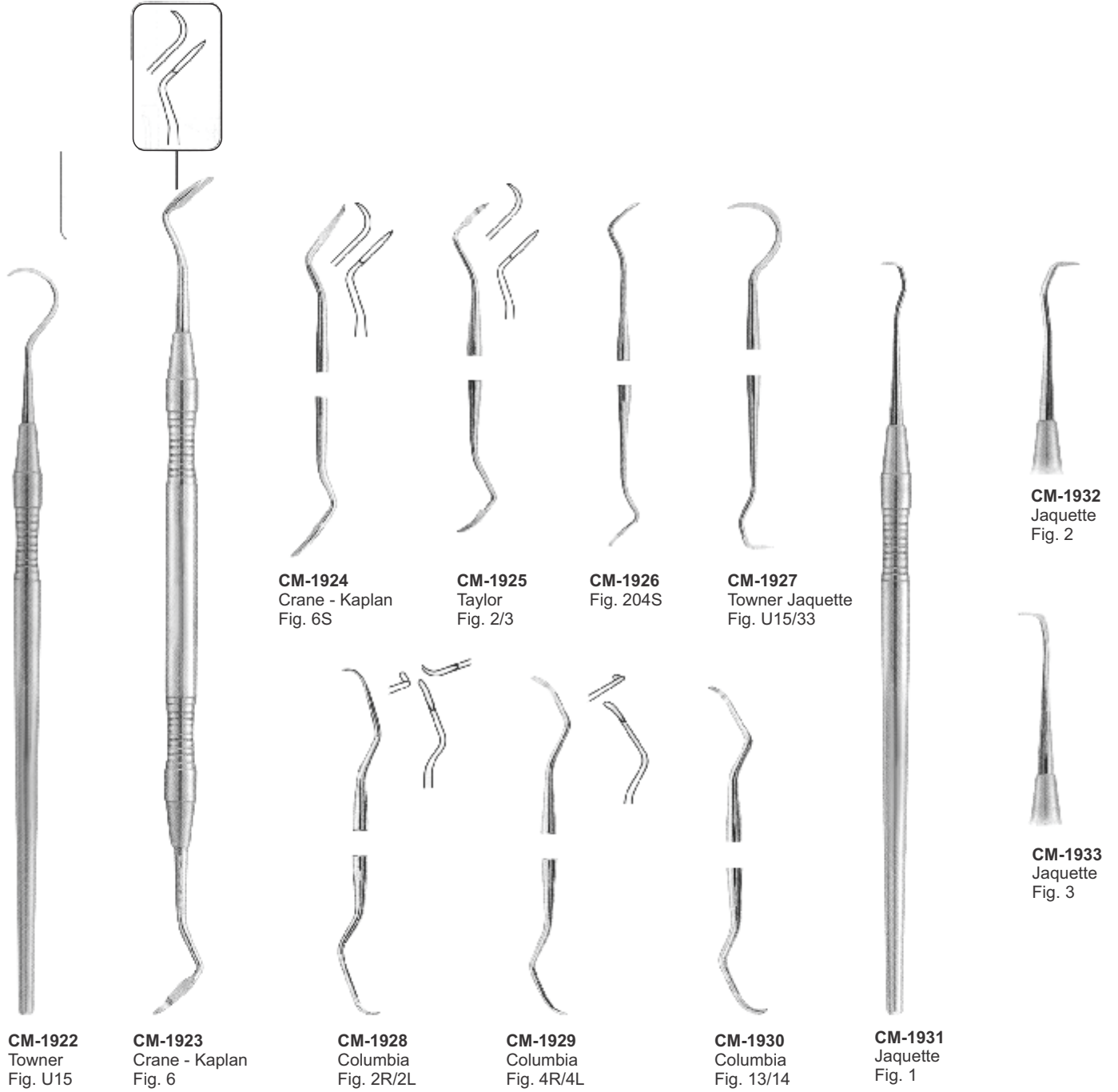



CM-1934
Hemingway
Fig. 1



CM-1935
Hemingway
Fig. 2



CM-1936
Hemingway
Fig. 3



CM-1937
Lucas
Fig. 85



CM-1938
Lucas
Fig. 86



CM-1939
Lucas
Fig. 87



CM-1940 Le Cron **CM-1941** Le Cron **CM-1942** Le Cron **CM-1943** MSY **CM-1944** MSY **CM-1945** Le Cron **CM-1946** Hylin **CM-1947** Hylin **CM-1948** Hylin **CM-1959** Zahle **CM-1950** Zahle **CM-1951** Zahle

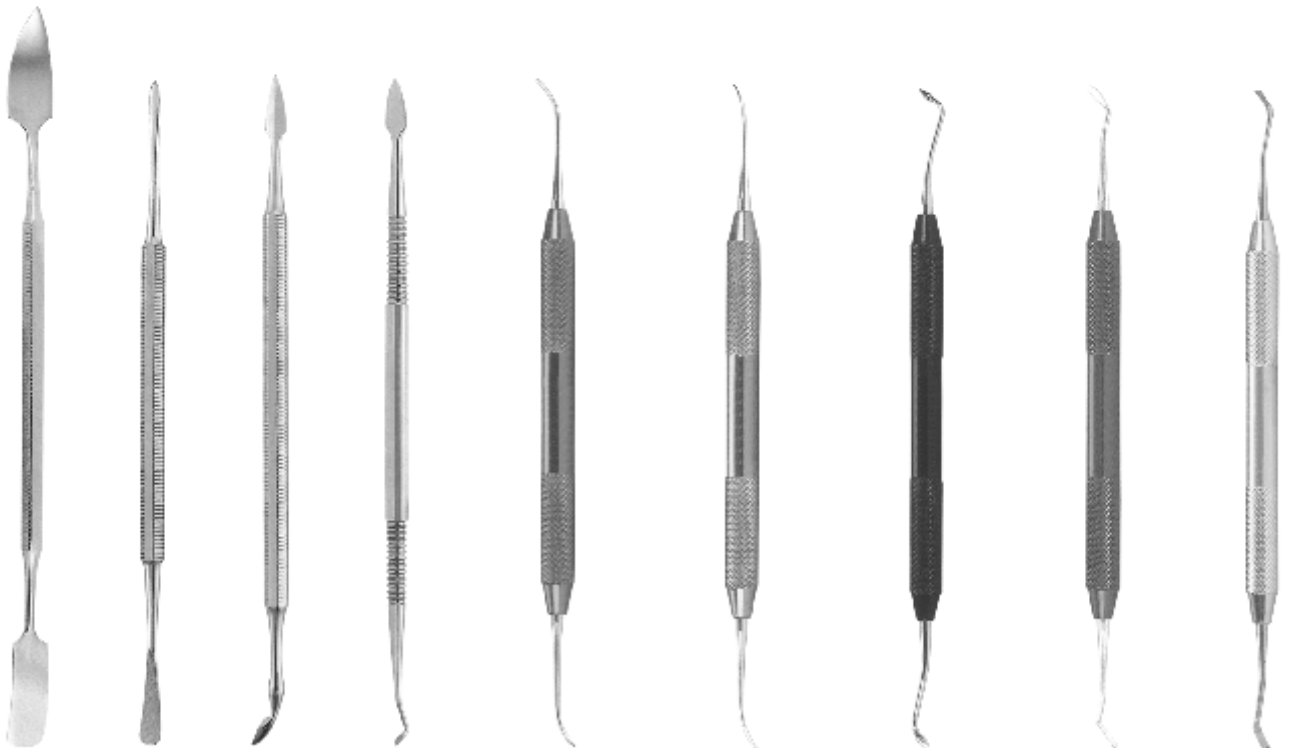

CM-1952 Gritman **CM-1953** Beale **CM-1954** Roach **CM-1955** Vehe **CM-1956** P.K. Thomas Fig. 1 **CM-1957** P.K. Thomas Fig. 2 **CM-1958** P.K. Thomas Fig. 3 **CM-1959** P.K. Thomas Fig. 4 **CM-1960** P.K. Thomas Fig. 5

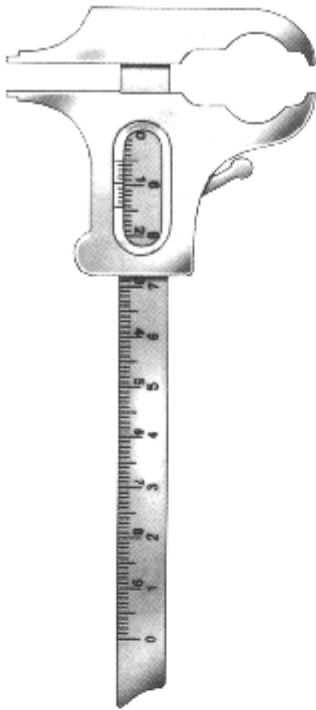

CM-1961
Boley



CM-1962
Zuricher
130 mm



CM-1963
Vernier
12 cm



CM-1964
Vernier

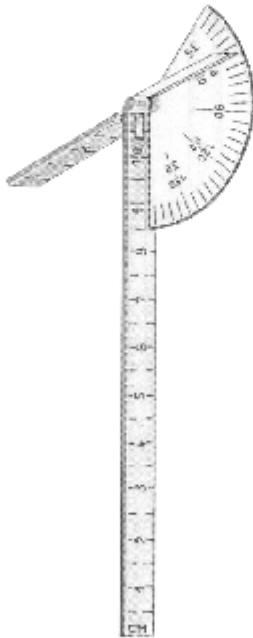

CM-1965
Carroll



CM-1966
Castroviejo's
Scleral Marker



CM-1967
Iwanson

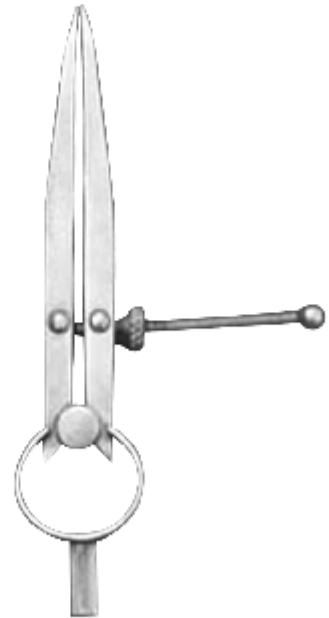

CM-1968
Albee



CM-1969
18 cm
7 1/8"



CM-1970
18 cm
7 1/8"



CM-1971
17 cm
6 3/4"
Gritman



CM-1972
17 cm
6 3/4"
Medicon



CM-1973
22 cm
8 3/4"



CM-1974
Antkoviak

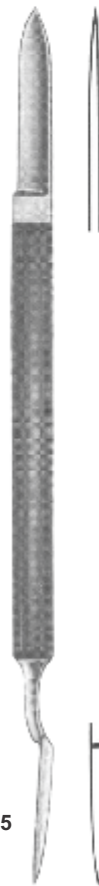

CM-1975
Ermert

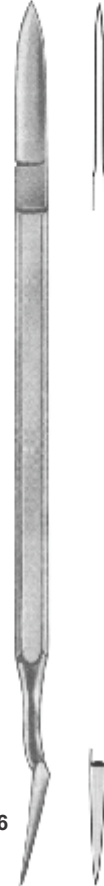

CM-1976
Ermert



CM-1977
Fahnenstock
Fig. 1
12,5cm



CM-1978
Fahnenstock
Fig. 2
17cm



CM-1979
Lessmann
Fig. 1
12,5cm



CM-1980
Lessmann
Fig. 2
17cm



CM-1981
Con scodellino
Fig. 1
12,5cm



CM-1982
Con scodellino
Fig. 2
17cm

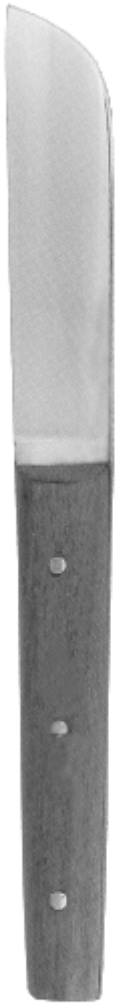

CM-1983
Fig, 1
17 cm



CM-1984
Gritman
Fig, 2
17 cm



CM-1985
Fig, 3
16 cm



CM-1986
Fig, 4
16 cm

Explorers



CM-1987
Fig 23



CM-1988
Fig 6



CM-1989
Fig 8



CM-1990
Fig 9



CM-1991
Fig 17



CM-1992
Fig 3
Rein



CM-1993
Fig 23/17



CM-1994
Fig 17

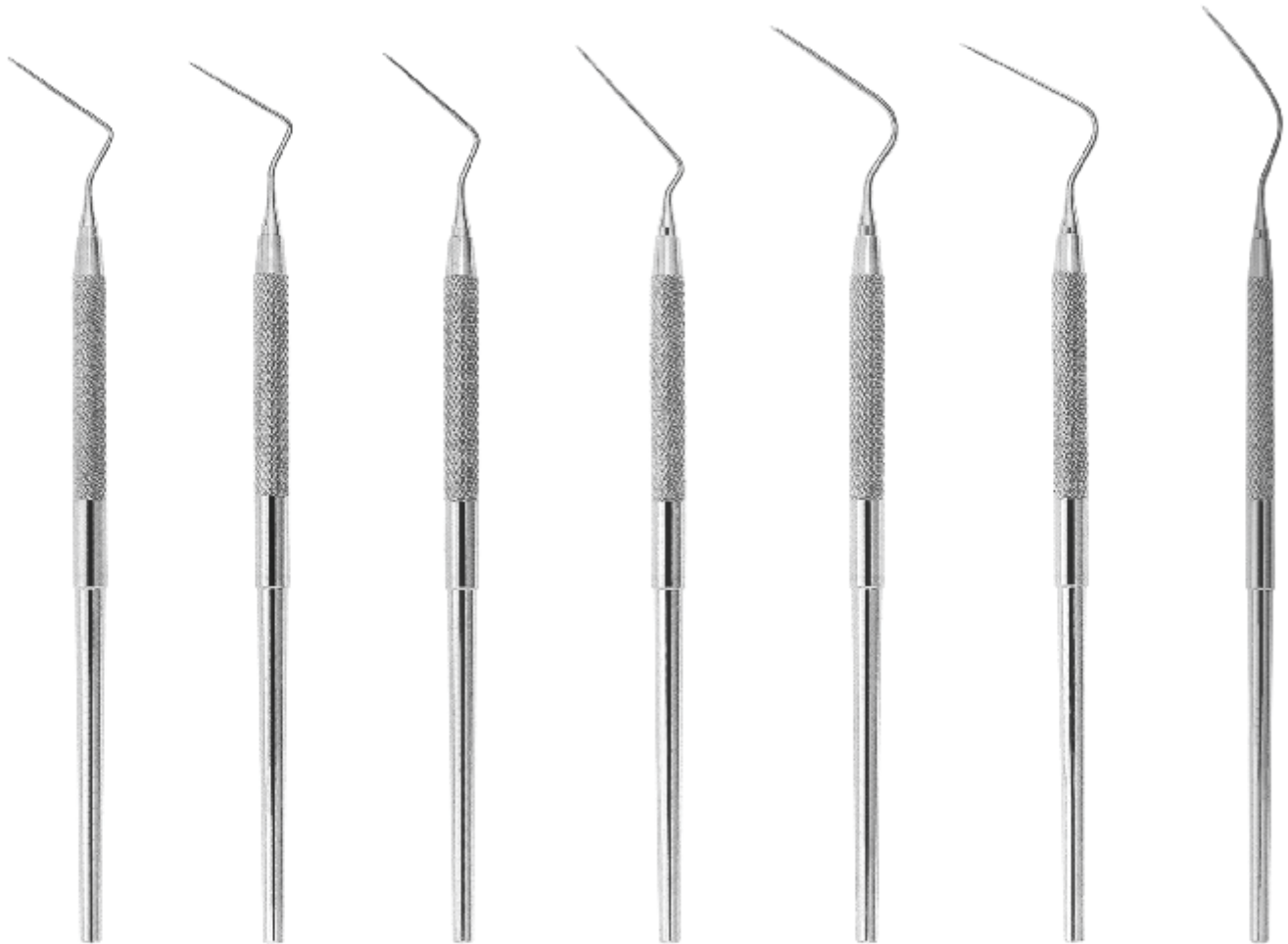

CM-1995
Fig.1
Spreader

CM-1996
Fig.2
Spreader

CM-1997
Fig.3
Spreader

CM-1998
Fig.4
Spreader

CM-1999
Fig.5
Spreader

CM-2000
Fig.6
Spreader

CM-2001
Fig.7
Spreader

Double-Ended Root Canal Explorers Plugger/Spreaders

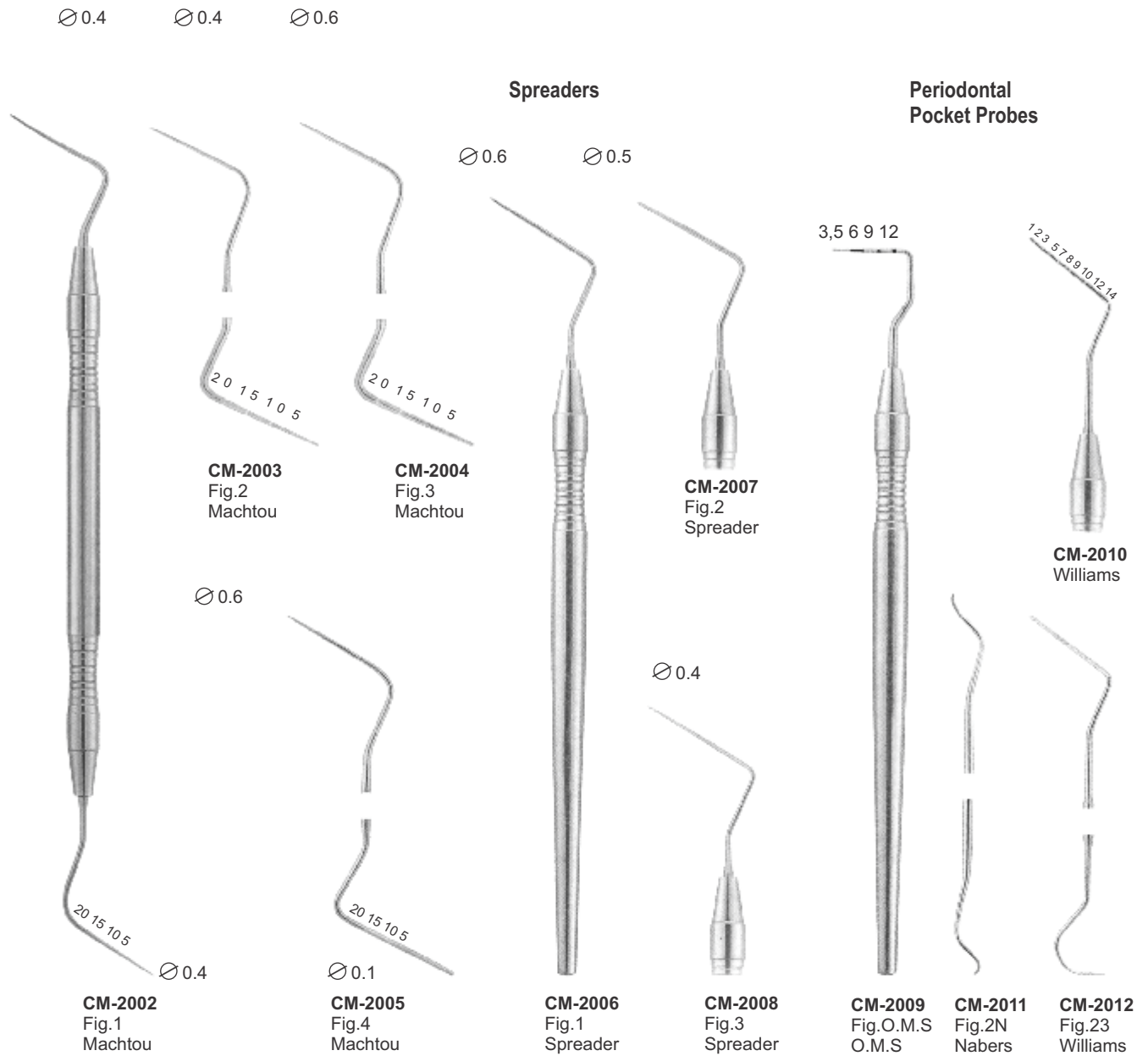

Root-canal pluggers

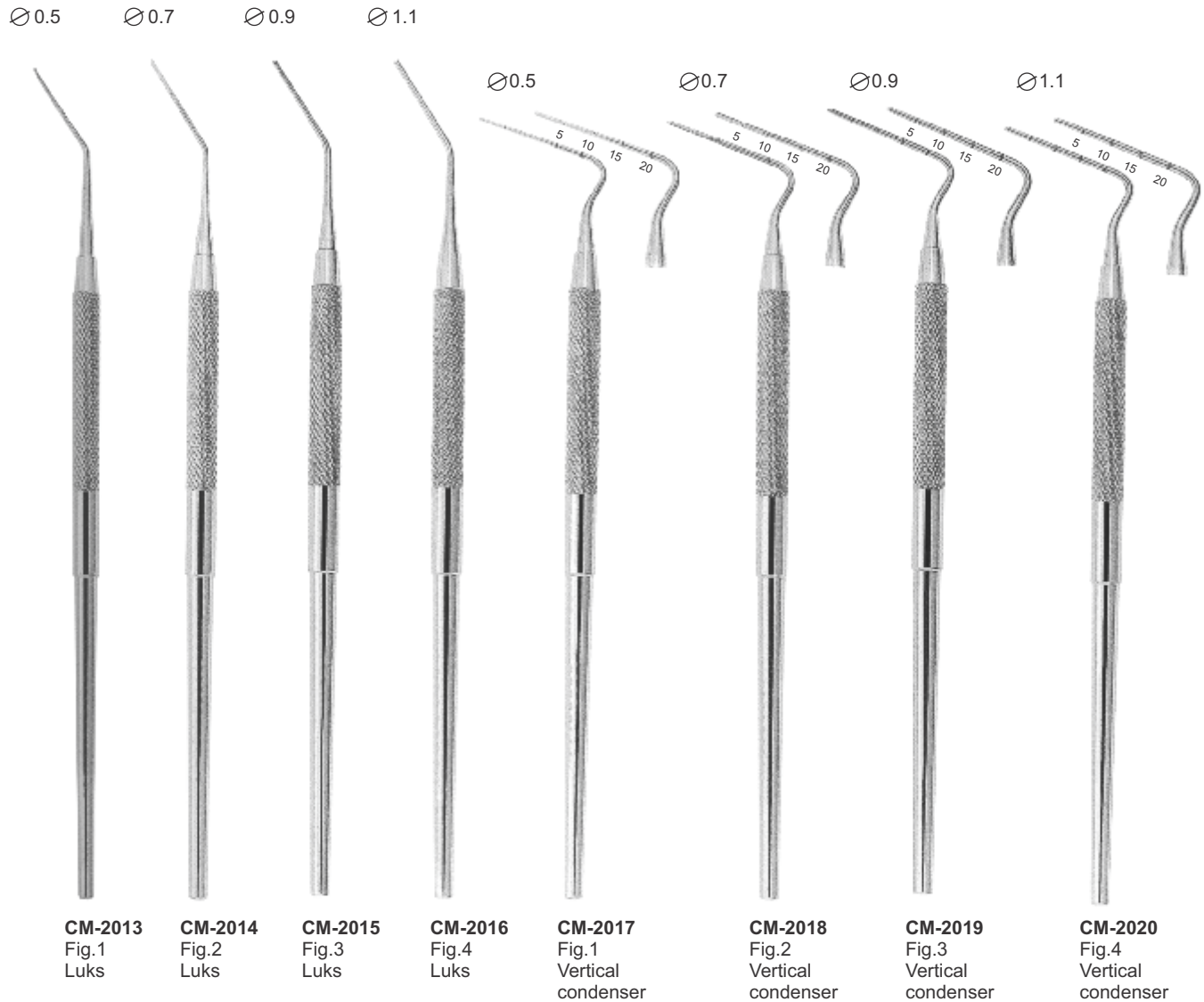

Endodontic set



CM-2021
Measuring Plate

Root-canal pluggers

Optimum Flexibility
Very Fine Points

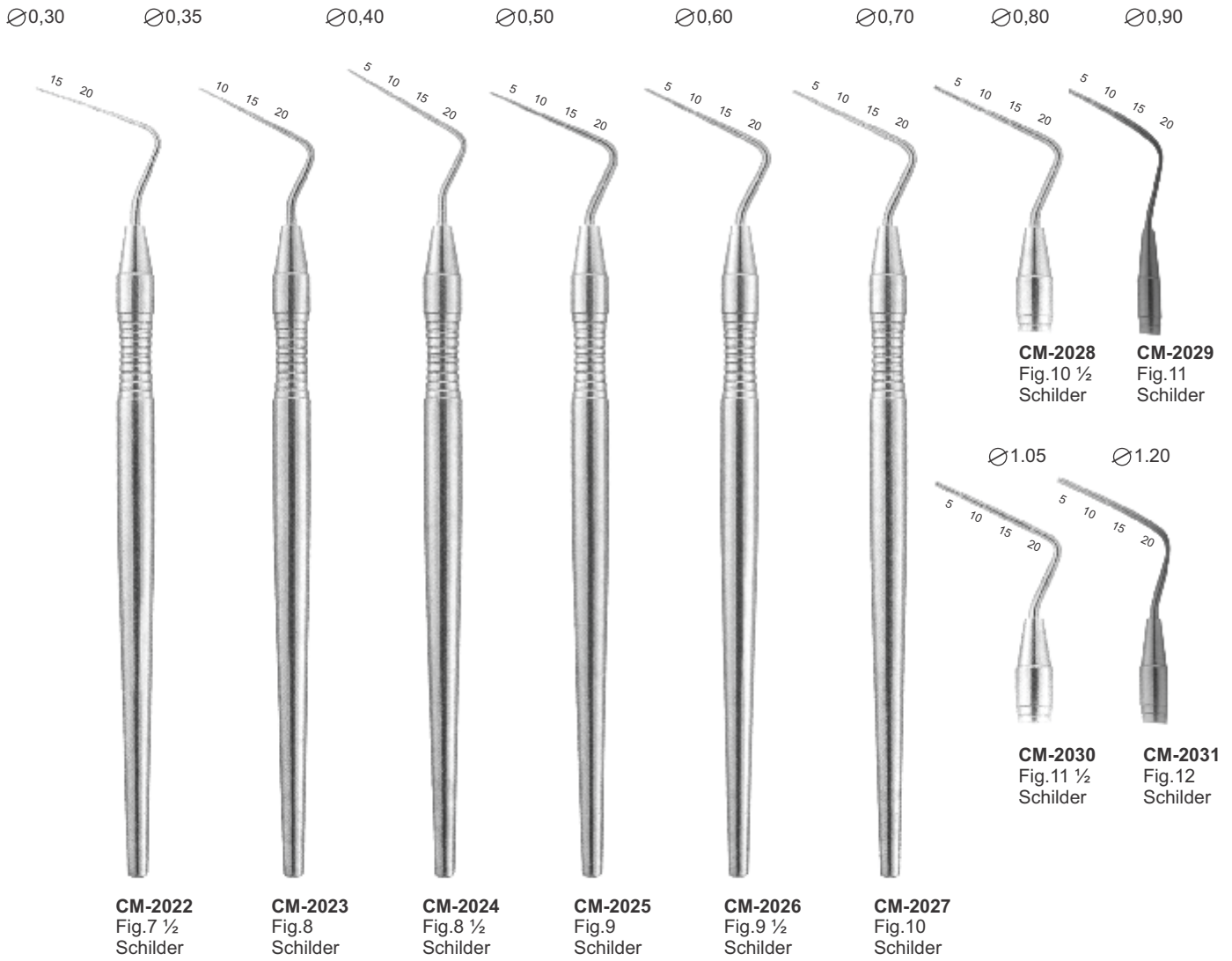

Root-canal explorers



CM-2032
Fig.6/1

CM-2033
Fig.6/17

CM-2034
Fig.6/23

Root-canal excavators



CM-2035
Fig.31L

CM-2036
Fig.32L

CM-2037
Fig.33L

1 mm



CM-2038
Fig 5

1.2 mm



CM-2039
Fig 14

1 mm



CM-2040
Fig 17

1.2 mm



CM-2041
Fig 18

1.6 mm



CM-2042
Fig 19

2 mm



CM-2043
Fig 20

1 mm



CM-2044
ASH
Fig.243

1,4 mm



CM-2045
ASH
Fig.G2

0,8 mm



CM-2046
Fig.1

0,8 mm



CM-2047
Fig.2

1 mm



CM-2048
Fig.11

1 mm



CM-2049
Fig.12

1,2 mm



CM-2050
Fig.21

1,2 mm



CM-2051
Fig.22

1,6 mm



CM-2052
Fig.31

1,6 mm



CM-2053
Fig.32

2 mm



CM-2054
Fig.41

2 mm



CM-2055
Fig.42

Set of 5 pieces

CM-2056 CM-2057 CM-2058

Plane

CM-2059
Fig.6
Ø 26 mm

CM-2060
Fig.5
Ø 24 mm

CM-2061
Fig.4
Ø 22 mm

CM-2062
Fig.4
Rhodium
Ø 22 mm

Front surface mouth mirrors

Magnifying

CM-2063
Fig.6
Ø 26 mm

CM-2064
Fig.5
Ø 24 mm

CM-2065
Fig.4
Ø 22 mm

CM-2066
Fig.5
Rhodium
Ø 24 mm

Hollow, stainless steel



CM-2067



CM-2068



CM-2069



CM-2070



CM-2071



CM-2072
Parallelometer
mouth mirror

CM-2073
Parallelometer
mouth mirror
+ handle
code 2101

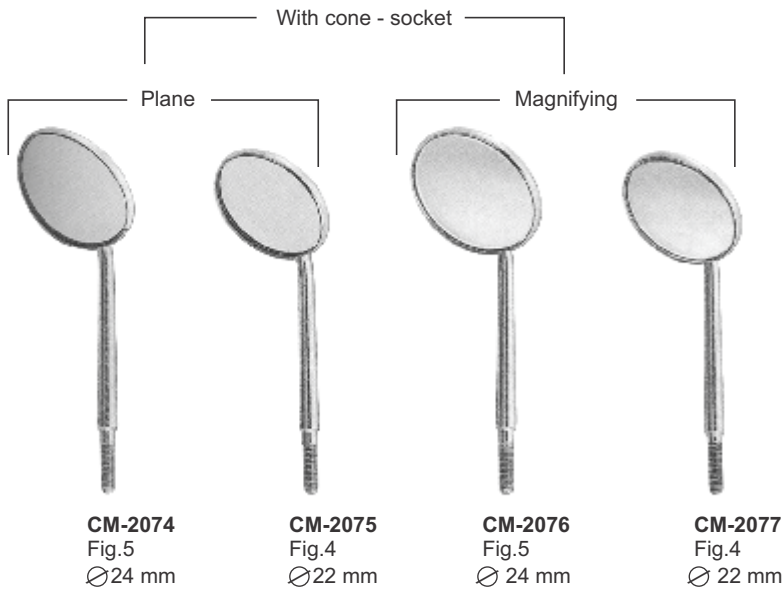

CM-2074
Fig.5
Ø24 mm

CM-2075
Fig.4
Ø22 mm

CM-2076
Fig.5
Ø 24 mm

CM-2077
Fig.4
Ø 22 mm



CM-2078
Cone - socket



CM-2079
Cone - socket



CM-2080
Cone - socket



CM-2081



CM-2082



CM-2083



CM-2084



CM-2085



CM-2086



CM-2087



CM-2088



CM-2089



CM-2090



CM-2091



CM-2092



CM-2093



CM-2094



CM-2095







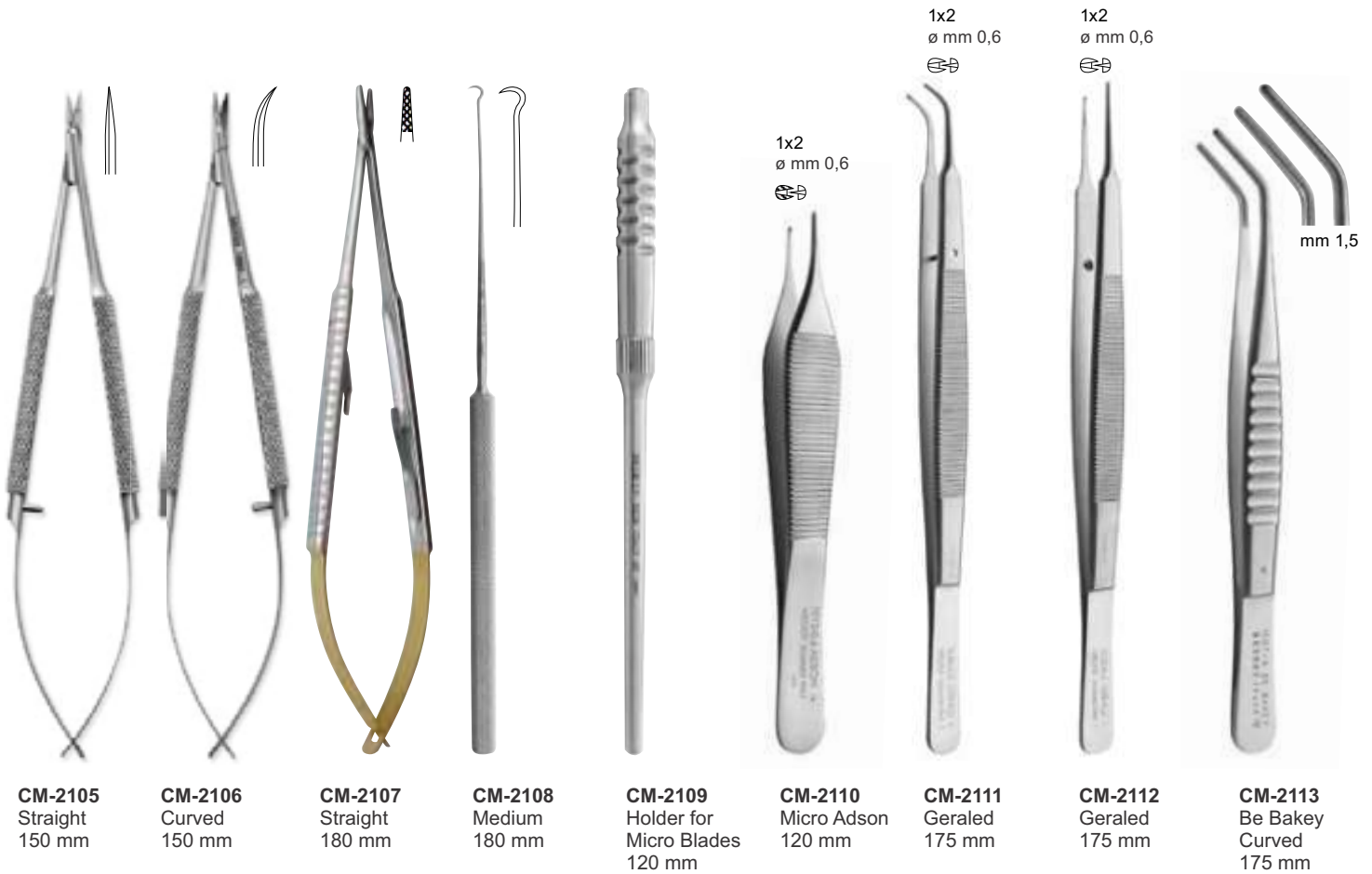

CM-214
Micro surgery set 9 pieces on tray

- CM-2107** Castroviejo – Straight / retto (mm 180)
- CM-2105** Micro scissor – Straight / Forbici – retta (mm 150)
- CM-2106** Micro scissor – Curved / Forbici – Curve (mm 150)
- CM-2108** Retractor
- CM-2110** Micro adson 1x2 mm 120 ø mm 0,6
- CM-2111** Geraled straight 1x2 mm 175 ø mm 0,6
- CM-2112** Geraled curved 1x2 mm 175 ø mm 0,6
- CM-2109** Handle for micro blades mm 120
- CM-2113** Debakey mm 150
- CM-2114** Tray mm 280x180x25





1x2
ø mm 0,

CM-2115
Round 1x2
180 mm



1x2
ø mm 0,9

CM-2116
Round 1x2
180 mm



CM-2117
Curved
180 mm



CM-2118
Curved
155 mm



CM-2119
Sinus lift instruments
175 mm



CM-2120
Holder for micro blades
120 mm



CM-2121



Package 25 pcs

- CM-2115** tweezer round, straight (mm 180)
- CM-2116** tweezer round, curved (mm 180)
- CM-2117** Needle holder (mm 180)
- CM-2118** Scissor spring action (mm 155)
- CM-2119** Sinus lift (mm 175)
- CM-2120** Handle micro blades (mm 120)
- CM-2121** Micro blades N-67
- CM-2122** Tray



CM-2122
Micro surgery set 7 pieces on tray Set



CM-2123
15 Instruments
mm 75 x 54 x 60



CM-2124
mm 195 x 90 x 35



CM-2125
10 Instruments
mm 260 x 160 x 24



Silicon Mat



CM-2127
Double Deck
mm 260 x 160 x 60

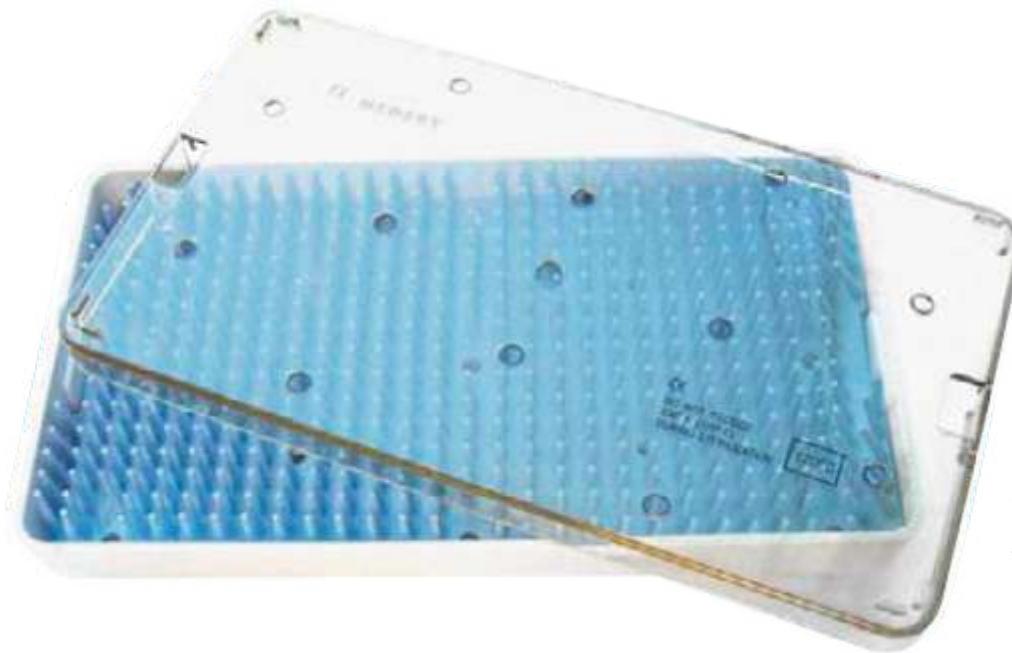

Silicon mat

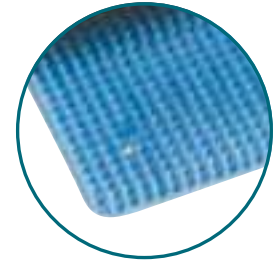

CM-2128
195 x 110 x 20
autoclavable up to 170°
Kit (cover-lid and silicone mat)



CM-2130 (Beige)
CM-2131 (Blue – Blu)
CM-2132 (green – Verde)
CM-2133 (red – rosso)
CM-2134 (White – Bianco)
mm 190 x 90 x 25



CM-2129
Our plastic trays are compatible with all sterilization technique including steam and dry autoclave. Specially designed silicone mats accommodate 5 various instruments. Available in 5 colours: beige, blue, green, red, white.



CARE MEDICAL[®]
SUPPLIES

Your health _ Our Priority

Section

04

Page 107-128

Orthodontic Instruments



inspiring
confidence in
health
care

www.caremedical.com.pk

Mini head distal end cutter with safety hold, long handles
Fitted with un-breakable, corrosion resistant & durable stainless steel tips

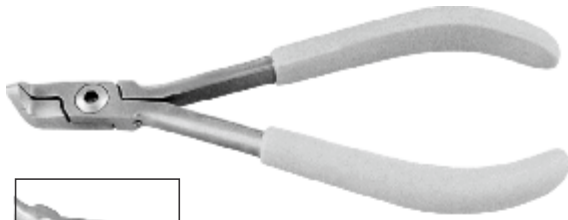

CM-2301
Max
13 cm

- 0.30 mm to 0.50 mm (.012" to .020")
- Max. 0.46 mm x 0.64 mm (.018" x .025")
- ⊗ 0.38 mm to 0.53 mm (.0155" to .0215")
- ⊗ Max. 0.53 mm x 0.64 mm (.021" x .025")

Hard wire cutter, 15° angled
Fitted with un-breakable, corrosion resistant & durable stainless steel tips



CM-2302
Max
13 cm

- 0.30 mm to 0.50 mm (.012" to .020")
- Max. 0.56 mm x 0.71 mm (.022" x .028")

Soft wire & ligature cutter, Mini
Fitted with un-breakable, corrosion resistant & durable stainless steel tips



CM-2303
Max
13 cm

- ⌋ .25 mm to .38 mm (.010" to .015")

Screw Tech Soft Grip Pliers

Band removing pliers

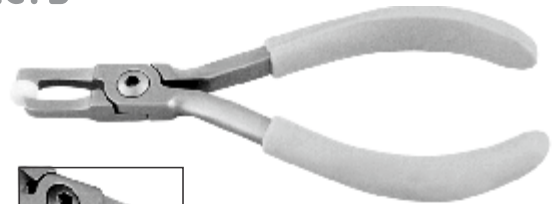

CM-2304
Max
13 cm

Bracket removing pliers with plastic tip

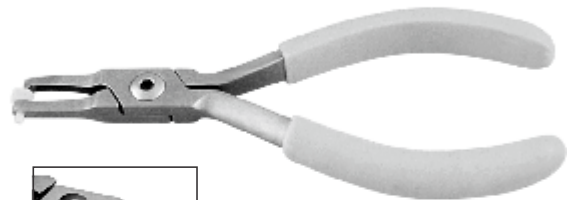

CM-2305
Max
13 cm

Utility pliers



CM-2306
Weingart
13 cm

- 0.30 mm to 0.50 mm (.012" to .020")
- Max. 0.56 mm x 0.71 mm (.022" x .028")



Silicone grip for orthodontic pliers
Comfortable, Non Slip, Reduce hand fatigue, Easy to put on & off
CM-2307 White pair

Standard distal end cutter with safety hold
Fitted with un-breakable, corrosion resistant & durable stainless steel tips

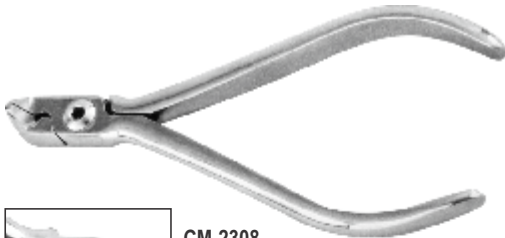

CM-2308
Max 13 cm
● 0.30 mm to 0.50 mm (.012" to .020")
■ Max. 0.56 mm x 0.71 mm (.022" x .028")

Screw Tech

Soft wire & ligature cutter, Mini
Fitted with un-breakable, corrosion resistant & durable stainless steel tips



CM-2312
Max 13 cm
☞ .25 mm to .38 mm (.010" to .015")

Mini head distal end cutter with safety hold
Fitted with un-breakable, corrosion resistant & durable stainless steel tips



CM-2309
Max 13 cm
● 0.30 mm to 0.50 mm (.012" to .020")
■ Max. 0.46 mm x 0.64 mm (.018" x .025")
☒ 0.38 mm to 0.53 mm (.0155" to .0215")
☒ Max. 0.53 mm x 0.64 mm (.021" x .025")

Soft wire and ligature cutter, standard
Fitted with un-breakable, corrosion resistant & durable stainless steel tips



CM-2313
Max 13 cm
☞ .25 mm to .38 mm (.010" to .015")

Distal end cutter with safety hold, mini head, long handles
Fitted with un-breakable, corrosion resistant & durable stainless steel tips



CM-2310
Max 13 cm
● 0.30 mm to 0.50 mm (.012" to .020")
■ Max. 0.46 mm x 0.64 mm (.018" x .025")
☒ 0.38 mm to 0.53 mm (.0155" to .0215")
☒ Max. 0.53 mm x 0.64 mm (.021" x .025")

Soft wire & ligature cutter, 15° angled
Fitted with un-breakable, corrosion resistant & durable stainless steel tips



CM-2314
Max 13 cm
☞ .25 mm to .38 mm (.010" to .015")

Flush-cut distal end cutter with safety hold
Fitted with un-breakable, corrosion resistant & durable stainless steel tips

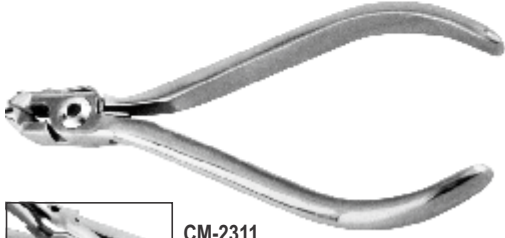

CM-2311
Max 13 cm
● 0.30 mm to 0.50 mm (.012" to .020")
■ Max. 0.46 mm x 0.64 mm (.018" x .025")

Soft wire & ligature cutter, 45° angled
Fitted with un-breakable, corrosion resistant & durable stainless steel tips



CM-2315
Max 13 cm
☞ .25 mm to .38 mm (.010" to .015")

Hard wire cutter, straight

Fitted with un-breakable, corrosion resistant & durable stainless steel tips



CM-2316

Max
13 cm

- 0.30 mm to 0.50 mm (.012" to .020")
- Max. 0.56 mm x 0.71 mm (.022" x .028")

**Screw
Tech**

Bracket removing pliers angled



CM-2320

Max
13 cm

Hard wire cutter, 15° angled

Non-autoclavable



CM-2317

Max
13 cm

- 0.30 mm to 0.50 mm (.012" to .020")
- Max. 0.56 mm x 0.71 mm (.022" x .028")

Bracket removing pliers straight



CM-2321

Max
13 cm

Hard wire cutter, 15° angled

Fitted with un-breakable, corrosion resistant & durable stainless steel tips

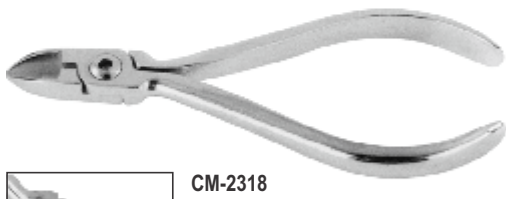

CM-2318

Max
13 cm

- 0.30 mm to 0.50 mm (.012" to .020")
- Max. 0.56 mm x 0.71 mm (.022" x .028")

Bracket removing pliers with plastic tip



CM-2322

Max
13 cm

Band removing pliers



CM-2319

Max
13 cm

Adhesive removing pliers



CM-2323

Max
13 cm

CM-2324 Replacement metal tip

Screw Tech

Utility pliers



CM-2325
Weingart-Mini
13 cm
● 0.30 mm to 0.50 mm (.012" to .020")
■ Max. 0.56 mm x 0.71 mm (.022" x .028")



CM-2326
Weingart
13 cm
● 0.30 mm to 0.50 mm (.012" to .020")
■ Max. 0.56 mm x 0.71 mm (.022" x .028")

Utility pliers



CM-2327
How
Straight 13 cm
● 0.30 mm to 0.50 mm (.012" to .020")
■ Max. 0.56 mm x 0.71 mm (.022" x .028")



CM-2328
How
Angled 13 cm
● 0.30 mm to 0.50 mm (.012" to .020")
■ Max. 0.56 mm x 0.71 mm (.022" x .028")

Wire bending & loop forming pliers



CM-2329
Angel (Bird beak)
13 cm
● 0.30 mm to 0.50 mm (.012" to .020")
■ Max. 0.56 mm x 0.71 mm (.022" x .028")

Light wire bending & loop forming pliers



CM-2330
Max
13 cm
● 0.30 mm to 0.50 mm (.012" to .020")
■ Max. 0.41 mm x 0.56 mm (.016" x .022")

Light wire bending pliers with cutter
Fitted with hard metal tips



CM-2331
Max
13 cm
● 0.30 mm to 0.50 mm (.012" to .020")
■ Max. 0.46 mm x 0.56 mm (.018" x .022")

Light wire bending & loop forming pliers with cutter



CM-2332
Max
13 cm
● 0.30 mm to 0.50 mm (.012" to .020")
■ Max. 0.46 mm x 0.56 mm (.018" x .022")

Light wire bending & loop forming pliers, grooved tip



CM-2333
Tweed
13 cm
● 0.30 mm to 0.50 mm (.012" to .020")
■ Max. 0.46 mm x 0.56 mm (.018" x .022")

**Screw
Tech**

Loop forming pliers with cutter



CM-2334
Tweed
13 cm
● 0.30 mm to 0.50 mm (.012" to .020")
■ Max. 0.53 mm x 0.64 mm (.021" x .025")

Archwire forming pliers, concave & convex tips



CM-2338
Hollow-Chop
13 cm
● 0.30 mm to 0.71 mm (.012" to .028")
■ Max. 0.56 mm x 0.71 mm (.022" x .028")

Light wire bending pliers



CM-2335
Jarabak
13 cm
● 0.30 mm to 0.50 mm (.012" to .020")
■ Max. 0.46 mm x 0.56 mm (.018" x .022")

Multi-purpose pliers (bird beak, De la rosa & cutter in one)



CM-2339
Max
13 cm
● 0.30 mm to 0.50 mm (.012" to .020")
■ Max. 0.46 mm x 0.56 mm (.018" x .022")

3-jaw wire bending pliers



CM-2336
Aderer
13 cm
● 0.30 mm to 0.50 mm (.012" to .020")
■ Max. 0.56 mm x 0.71 mm (.022" x .028")

Distal end bending pliers

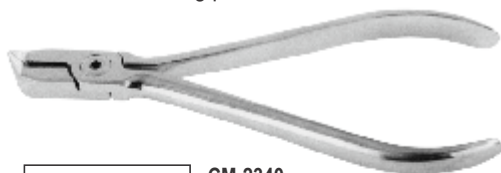

CM-2340
Max (Cinch back / tie back)
13 cm
● 0.30 mm to 0.50 mm (.012" to .020")
■ Max. 0.56 mm x 0.71 mm (.022" x .028")

Ligature forming pliers



CM-2337
Max
13 cm
□ .25 mm to .38 mm (.010" to .015")

Distal end bending pliers



CM-2341
Max (Hammer head)
13 cm
● 0.30 mm to 0.50 mm (.012" to .020")
■ Max. 0.56 mm x 0.71 mm (.022" x .028")

Screw Tech

Loop forming pliers



CM-2342

Nance
13 cm

- 0.36 mm to 0.71 mm (.014" to .028")
- Max. 0.56 mm x 0.71 mm (.022" x .028")

Torquing pliers set



CM-2346

Max
13 cm

Detailing step pliers / Bayonet bending pliers - 1mm



CM-2343

Max
13 cm

- 0.30 mm to 0.50 mm (.012" to .020")
- Max. 0.56 mm x 0.71 mm (.022" x .028")

Rectangular arch forming & torquing pliers



CM-2347

Tweed / angel
13 cm

- 0.30 mm to 0.71 mm (.012" to .028")
- Max. 0.56 mm x 0.71 mm (.022" x .028")

Stop pliers V- Bend - 1mm



CM-2344

Max
13 cm

- 0.30 mm to 0.50 mm (.012" to .020")
- Max. 0.43 mm x 0.56 mm (.017" x .022")

Surgical ball hook crimping pliers, angled



CM-2348

Max
13 cm

Lingual / palatal arch forming pliers

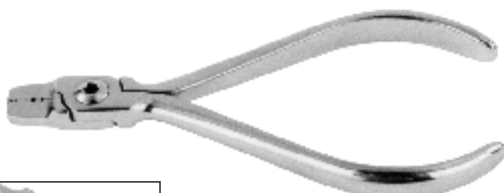

CM-2345

Max
13 cm

- 0.76 mm (.030") / 0.91 mm (.036")

Surgical ball hook crimping pliers, straight



CM-2349

Max
13 cm

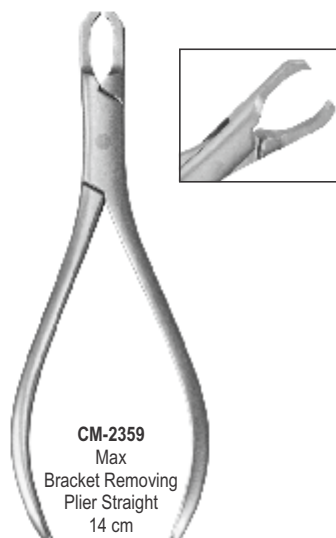
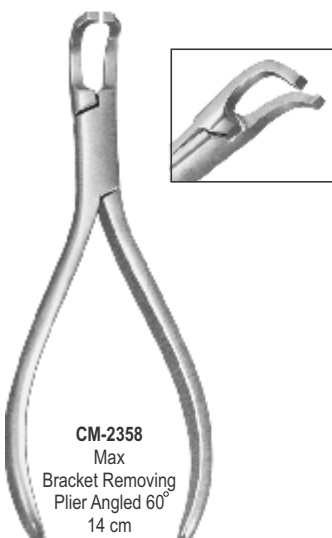
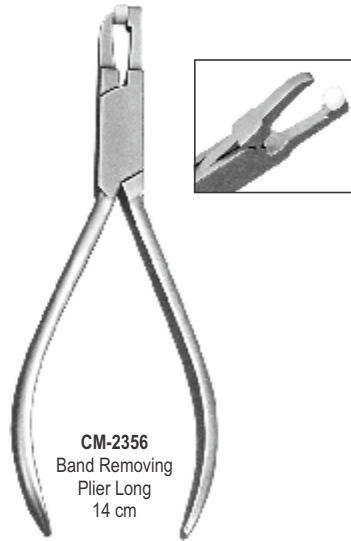
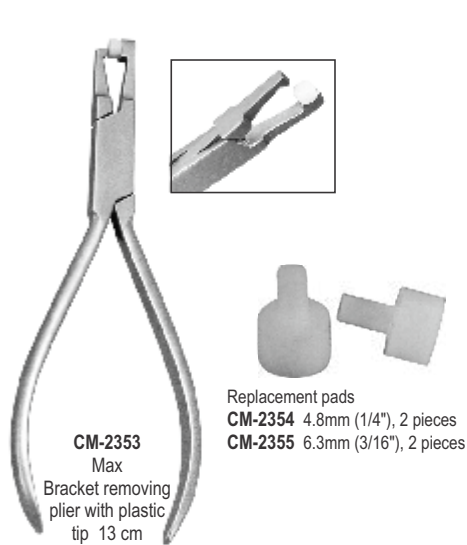

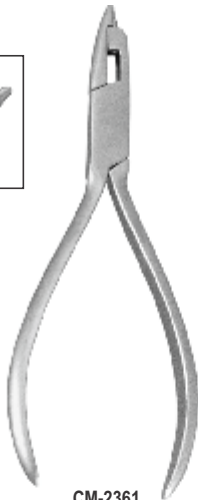
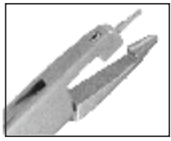

CM-2362
Replacement tip stainless 440 for Omega or Tweed loop forming pliers.
Tip diameters: 1.14mm, 1.52mm & 1.91 mm



CM-2363
Omega 13 cm
Loop forming pliers with replaceable stainless steel tip, three step tip has 1.14, 1.52 & 1.91 mm diameters

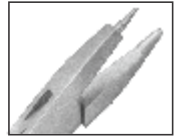

CM-2364
Tweed
Loop forming plier
13 cm



CM-2365
Angled

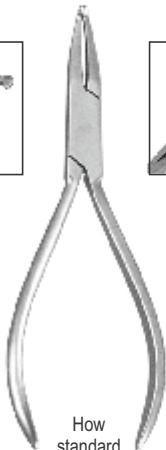

How standard
4 mm wide tips
13 cm



CM-2366
Straight



CM-2367
Band Seating
Plier 13 cm

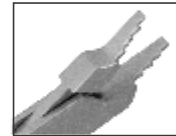

CM-2368
Nance
Loop forming plier
with four steps beak
13 cm



CM-2369
Tweed
Loop forming plier
13 cm



CM-2370
Weingart Mini
13 cm



CM-2371
Weingart
13 cm



CM-2372
Weingart Narrow
Narrow long tips for better
access to reach hard areas
13 cm

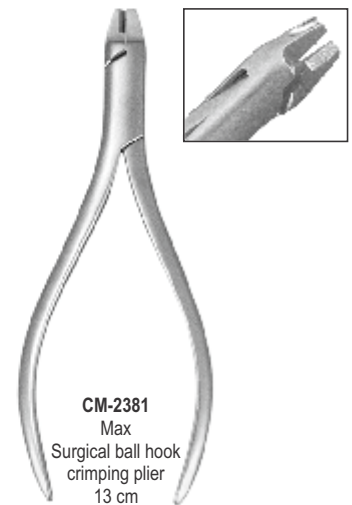
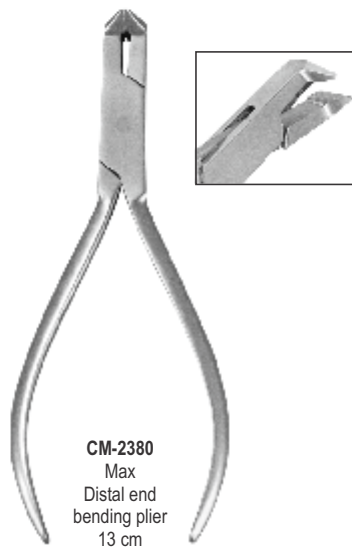
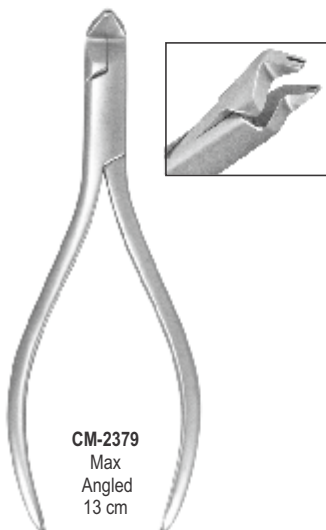
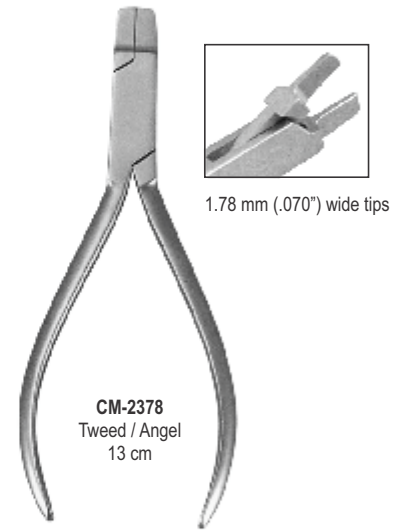
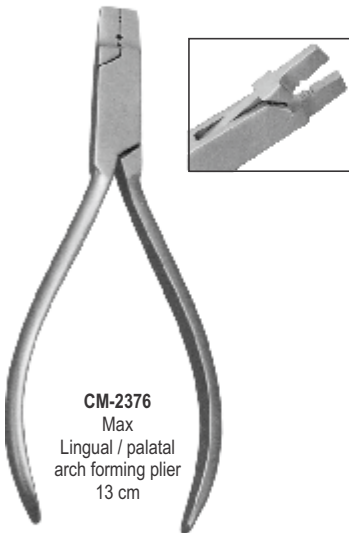
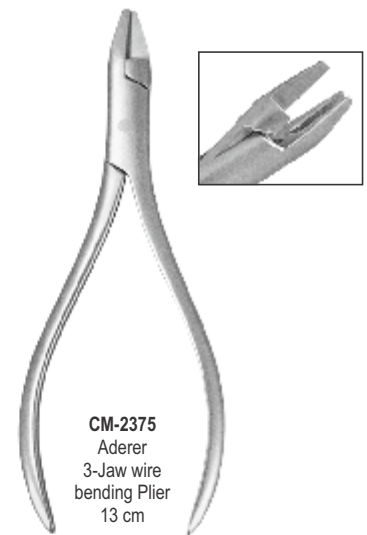

→●← →■←
 .028" .028"
 0.7 mm 0.7 mm



CM-2382
 Adams Mini
 12 cm

→●← →■←
 .035" .035"
 0.9 mm 0.9 mm

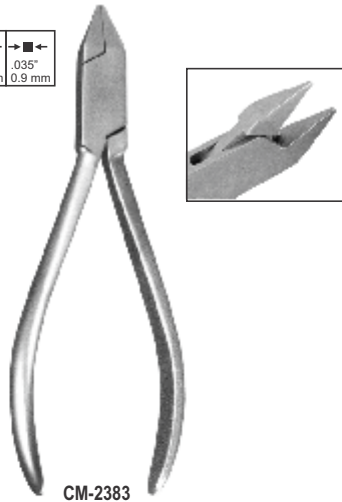

CM-2383
 Adams Maxi
 12.5 cm



CM-2384
 Round nose plier
 Fine pattern
 13 cm

→●← →■←
 .028" .028"
 0.7 mm 0.7 mm

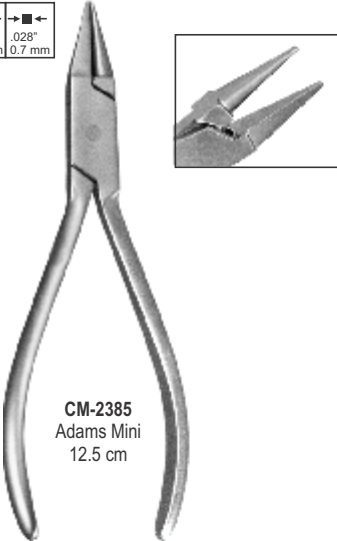

CM-2385
 Adams Mini
 12.5 cm

→●← →■←
 .035" .035"
 0.9 mm 0.9 mm

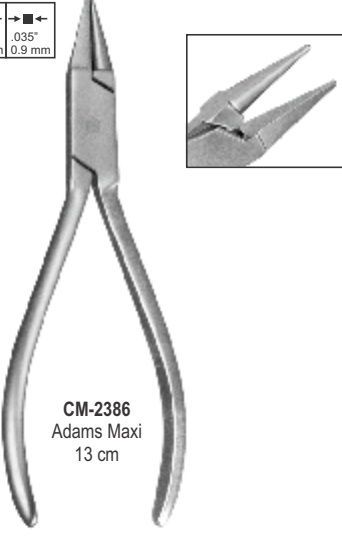

CM-2386
 Adams Maxi
 13 cm

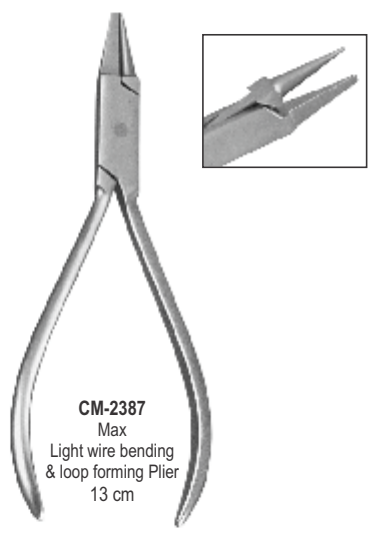

CM-2387
 Max
 Light wire bending
 & loop forming Plier
 13 cm

→●← →■←
 .035" .035"
 0.9 mm 0.9 mm



CM-2388
 Angel
 Bird beak Lab. Plier
 13 cm

→●← →■←
 .035" .035"
 0.9 mm 0.9 mm



CM-2389
 Angel
 Round nose wire
 bending loop forming plier
 13 cm



CM-2390
 Angel
 Round nose wire bending
 & loop forming plier
 13 cm

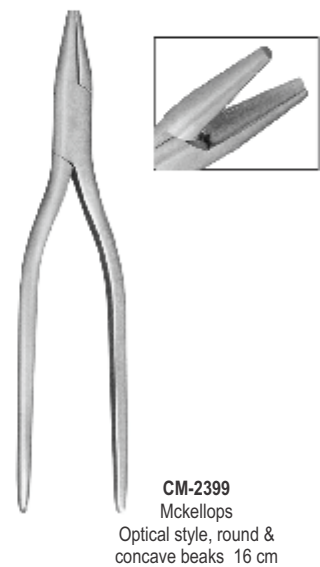
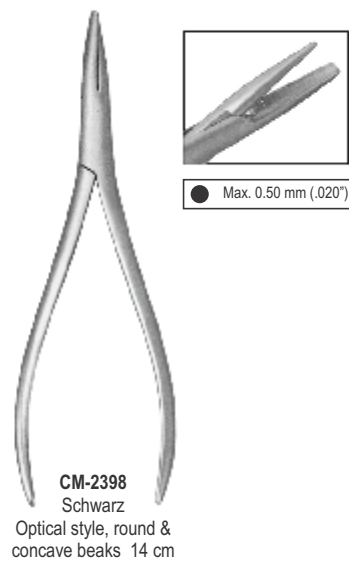
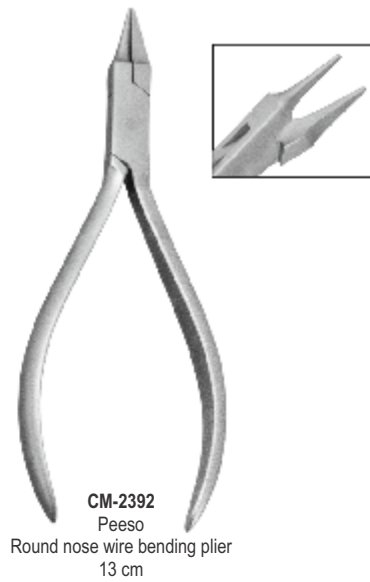
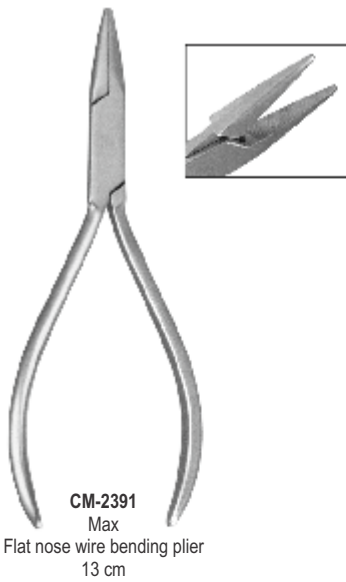

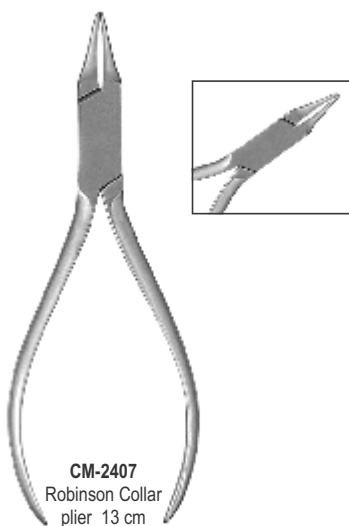
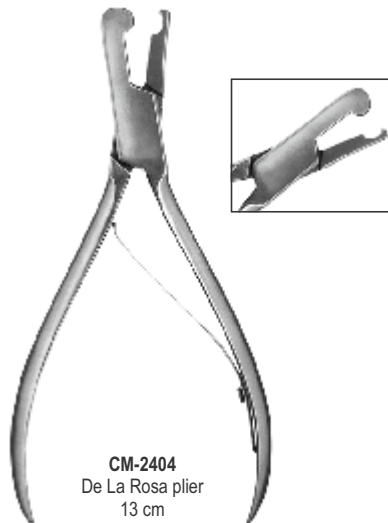
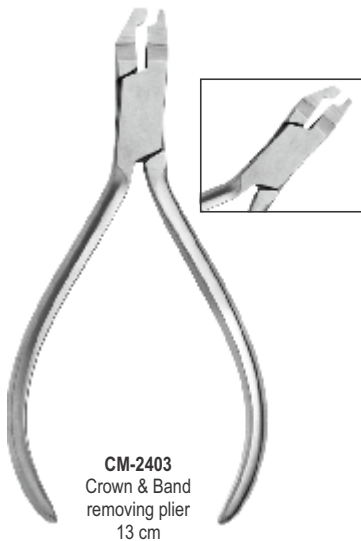
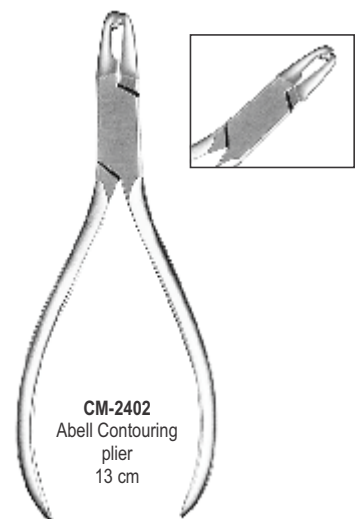
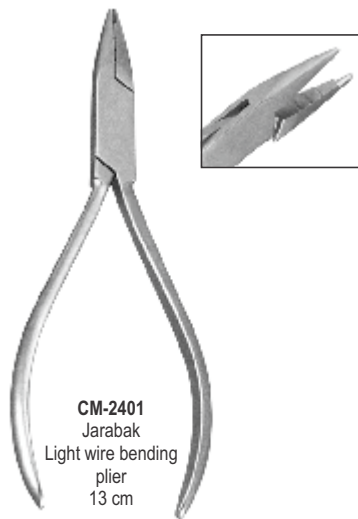
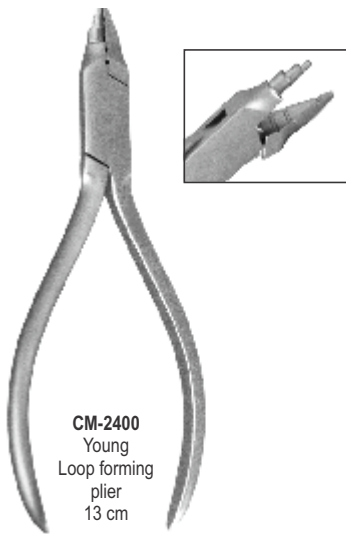



CM-2409
Serrated Laboratory
plier 14 cm



CM-2410
Smooth Laboratory
plier 14 cm

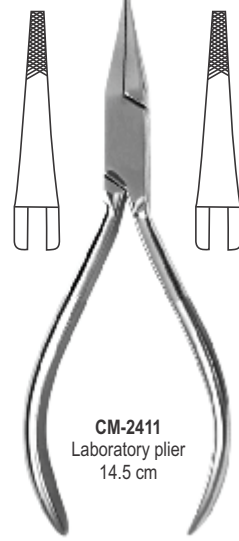
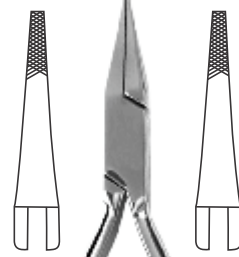

CM-2411
Laboratory plier
14.5 cm

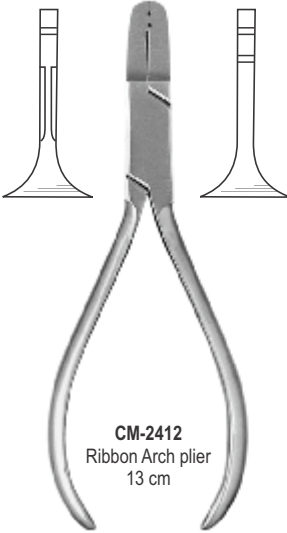
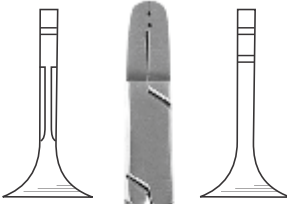

CM-2412
Ribbon Arch plier
13 cm



CM-2413
13 cm

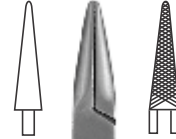

CM-2414
Goslee contouring
plier 13 cm

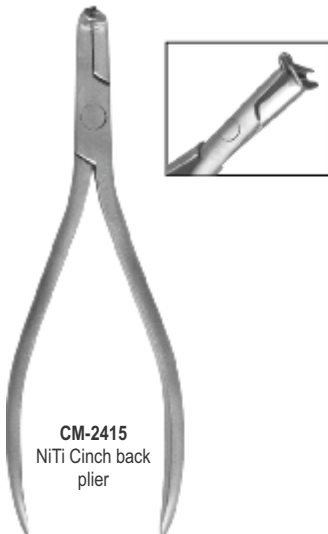

CM-2415
NiTi Cinch back
plier

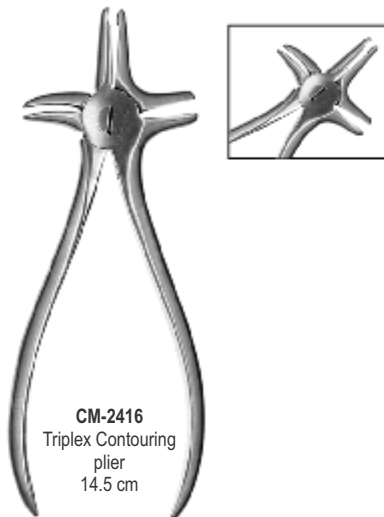

CM-2416
Triplex Contouring
plier
14.5 cm

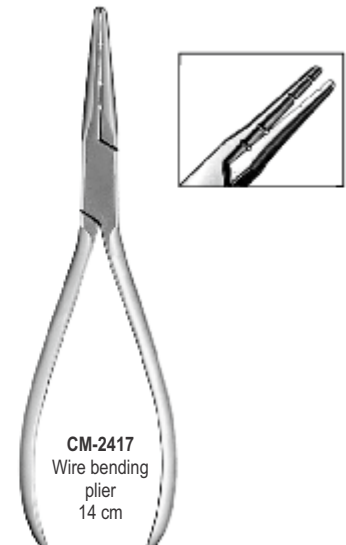

CM-2417
Wire bending
plier
14 cm



CM-2418
De La Rosa
Graduated
13 cm



CM-2419
De La Rosa
Smooth
13 cm



CM-2420
Andresen wire
bending plier
13 cm

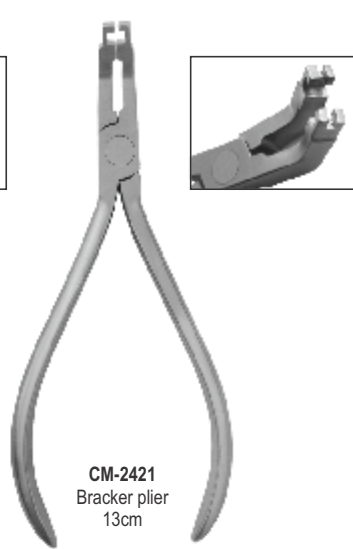

CM-2421
Bracker plier
13cm



CM-2422
Aderer-Mini



CM-2423
Aderer-Maxi



CM-2424
Three Jaw plier
round 13 cm



CM-2425
Wire bending plier
13 cm



CM-2426
Aderer
Facebow Loop
Forming Pliers
14.5 cm

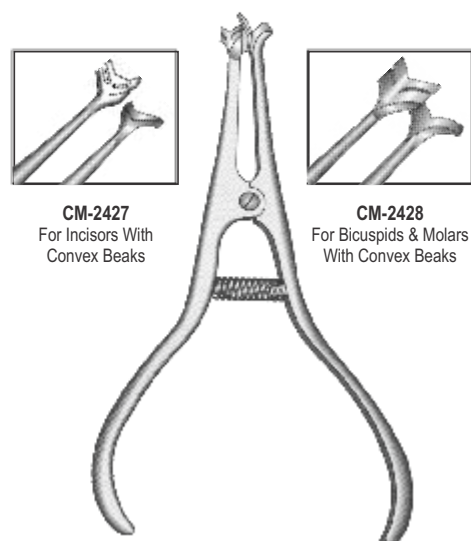

CM-2427
For Incisors With
Convex Beaks

CM-2428
For Bicuspsids & Molars
With Convex Beaks

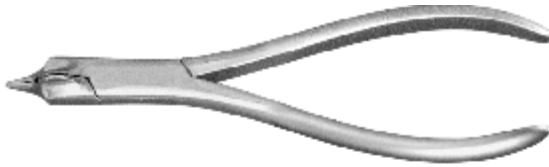

CM-2429
Universal-Dolphin style
Wire bending & cutting plier
16 cm

● Bends: 0.9 mm (.036")
● Cuts: 0.7 mm (.028")

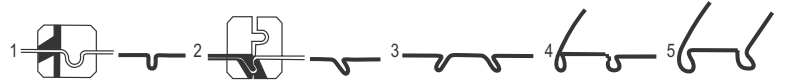

CM-2433
Nance
Adams clasp forming plier
13 cm

Max. 0.70 mm (.028")

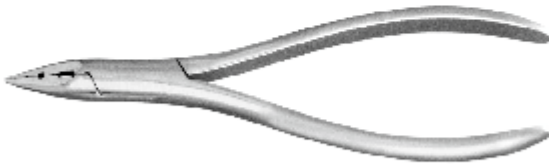

CM-2430
Universal-Taper style
Wire bending & cutting plier
16 cm

● Bends: 0.9 mm (.036")
● Cuts: 0.7 mm (.028")

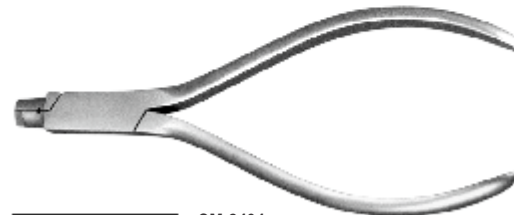

CM-2434
Schwarz
Arrow clasp forming plier
13 cm

Max. 0.70 mm (.028")

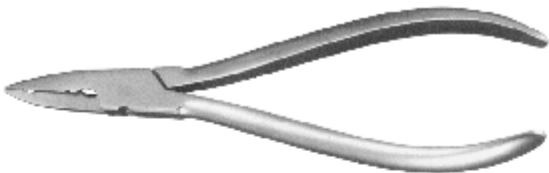

CM-2431
Waldasachs
Wire bending & cutting plier
15 cm

● Bends: 0.9 mm (.036")
● Cuts: 0.7 mm (.028")

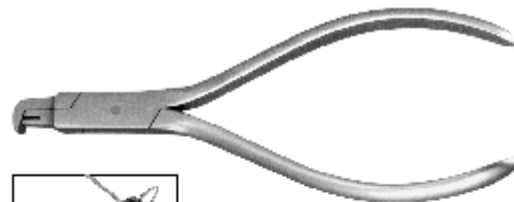

CM-2435
Schwarz
Arrow clasp forming plier
13 cm

Max. 0.70 mm (.028")



CM-2432
Universal
parallel jaw Plier
with side cutter

Max. 1.80 mm (.071")

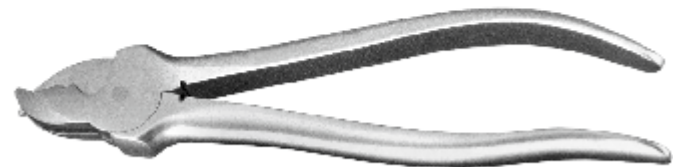

CM-2436
Magnum
Universal facebow loop
forming & cutting plier

Max. 1.80 mm (.071")

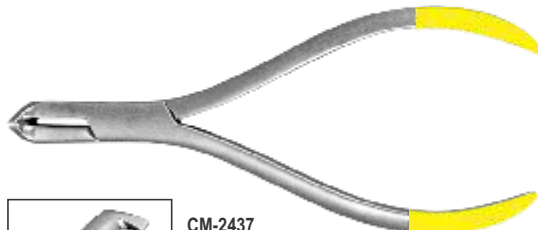
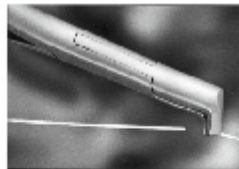

CM-2437
Max
Distal end cutter
with long handle
13 cm

- Max. 0.30 mm to 0.50 mm (.012" to .020")
- Max. 0.46 mm x 0.64 mm (.018" x .025")
- ⊗ Max. 0.38 mm to 0.53 mm (.0155" to .0215")
- ⊗ Max. 0.53 mm x 0.64 mm (.021" x .025")

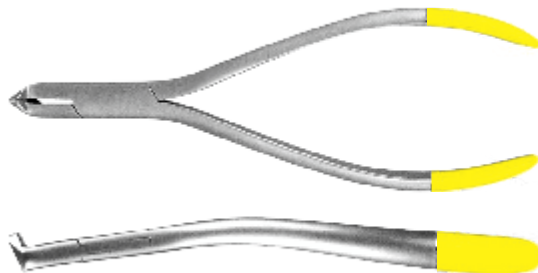

CM-2438
Max
Distal end cutter
with long handle
13 cm

- Max. 0.30 mm to 0.50 mm (.012" to .020")
- Max. 0.46 mm x 0.64 mm (.018" x .025")
- ⊗ Max. 0.38 mm to 0.53 mm (.0155" to .0215")
- ⊗ Max. 0.53 mm x 0.64 mm (.021" x .025")

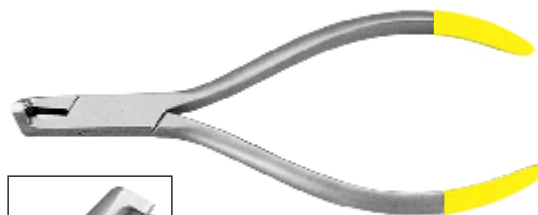

CM-2439
Max
Distal end cutter
13 cm

- Max. 0.30 mm to 0.50 mm (.012" to .020")
- Max. 0.46 mm x 0.64 mm (.018" x .025")
- ⊗ Max. 0.38 mm to 0.53 mm (.0155" to .0215")
- ⊗ Max. 0.53 mm x 0.64 mm (.021" x .025")

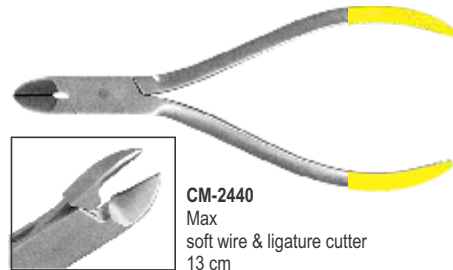

CM-2440
Max
soft wire & ligature cutter
13 cm

- ⌋ .25 mm to .38 mm (.010" to .015")

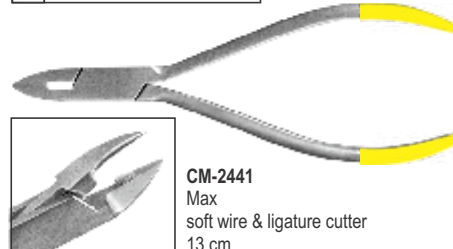

CM-2441
Max
soft wire & ligature cutter
13 cm

- ⌋ .25 mm to .38 mm (.010" to .015")

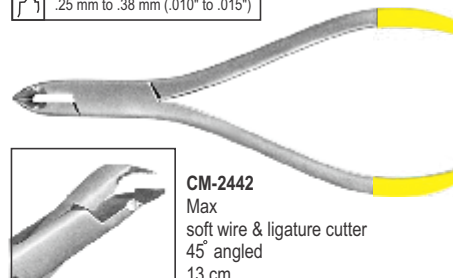

CM-2442
Max
soft wire & ligature cutter
45° angled
13 cm

- ⌋ .25 mm to .38 mm (.010" to .015")

Heavy Box Joint Construction Cutters

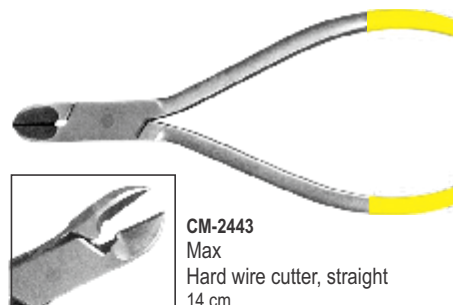

CM-2443
Max
Hard wire cutter, straight
14 cm

- Max. 0.30 mm to 0.50 mm (.012" to .020")
- Max. 0.56 mm x 0.71 mm (.018" x .025")

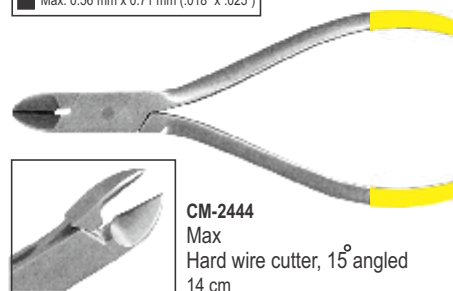

CM-2444
Max
Hard wire cutter, 15° angled
14 cm

- Max. 0.30 mm to 0.50 mm (.012" to .020")
- Max. 0.56 mm x 0.71 mm (.022" x .028")



CM-2445
Max
Hard side cutter
14 cm
● 0.70 mm to 1.00 mm (.028" to .040")



CM-2447
Max
Hard end cutter
14 cm
● 0.70 mm to 1.00 mm (.028" to .040")

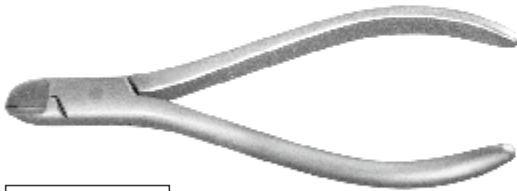

CM-2446
Max
Hard side cutter
14 cm
● 0.60 mm to 0.80 mm (.024" to .032")



CM-2448
Max
Hard end cutter
14 cm
● 0.60 mm to 0.80 mm (.024" to .032")

Heavy duty hard wire cutters cut heavy wires with little force



CM-2449
Small
Stainless steel, autoclavable
● 0.87 mm to 1.1 mm (.028" to .045")

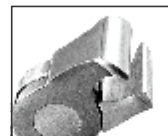

CM-2451
Small
Stainless steel, autoclavable
● 0.87 mm to 1.1 mm (.028" to .045")



CM-2450
Large
Stainless steel, autoclavable
● 0.87 mm to 1.50 mm (.032" to .057")

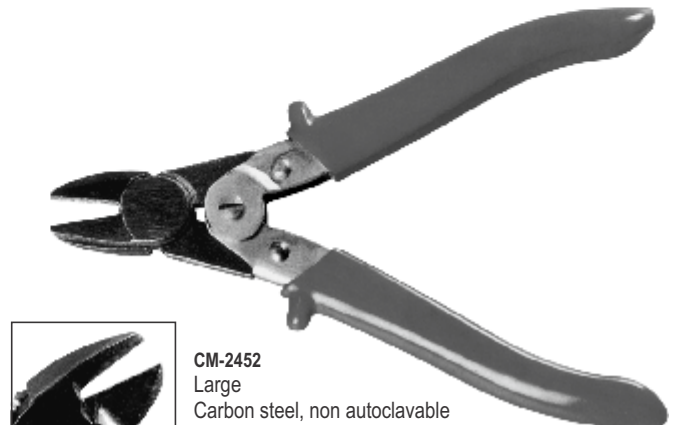

CM-2452
Large
Carbon steel, non autoclavable
● 0.87 mm to 1.50 mm (.032" to .057")

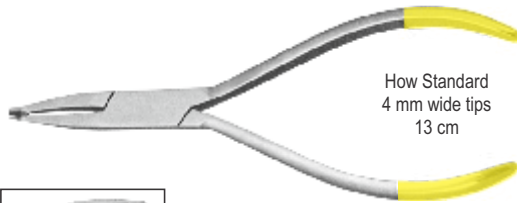

How Standard
4 mm wide tips
13 cm



CM-2453
Angled

- 0.30 mm to 0.50 mm (.012" to .020")
- Max. 0.56 mm x 0.71 mm (.022" x .028")



CM-2458
Goldman-Fox
10 cm



CM-2454
Straight

- 0.30 mm to 0.50 mm (.012" to .020")
- Max. 0.56 mm x 0.71 mm (.022" x .028")

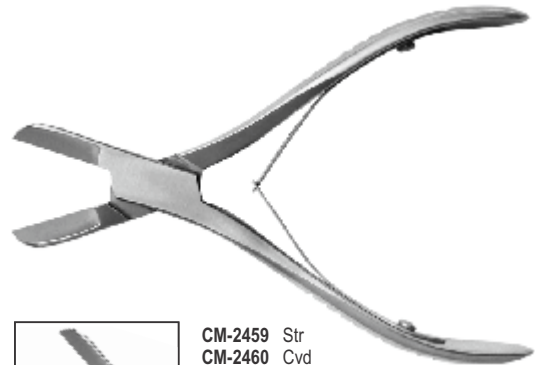

CM-2459 Str
CM-2460 Cvd
Liston Bone cutter
14 cm



CM-2455
Weingart Mini
13 cm

- 0.30 mm to 0.50 mm (.012" to .020")
- Max. 0.56 mm x 0.71 mm (.022" x .028")

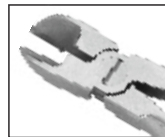

CM-2461 with TC
CM-2462 without TC
Wire Cutter Plier
14 cm



CM-2456
Weingart
13 cm

- Max. 0.30 mm to 0.50 mm (.012" to .020")
- Max. 0.56 mm x 0.71 mm (.022" x .028")



CM-2457
Max
Soft wire & ligature cutter
13 cm

- .25 mm to .38 mm (.010" to .015")



CM-2463 with TC
CM-2464 without TC
Wire Cutter Plier
with plastic grip
14 cm

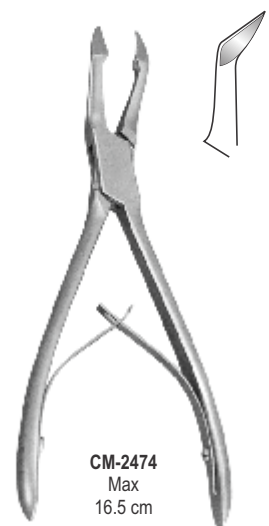
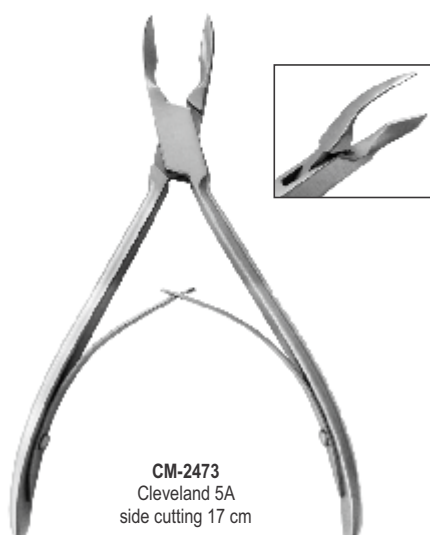
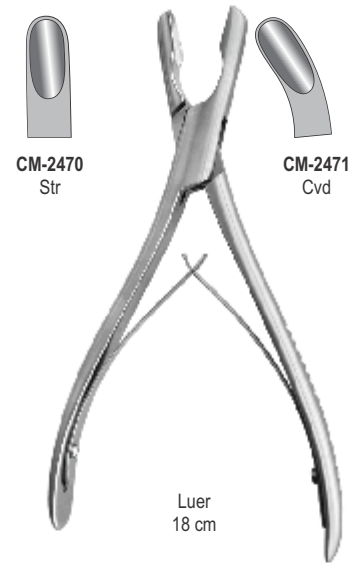
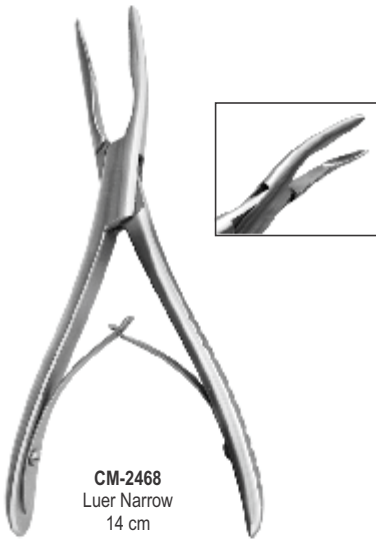
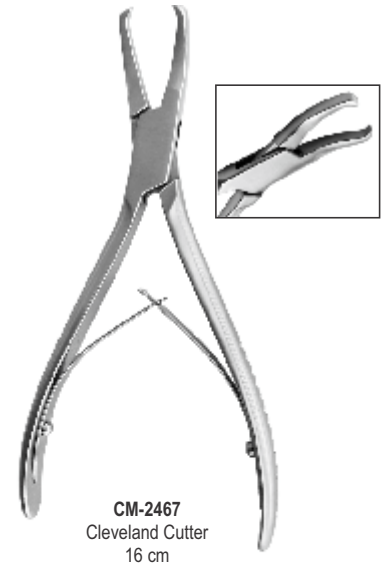



CM-2475

CM-2476



Friedmann-Mini
12.5 cm



30°

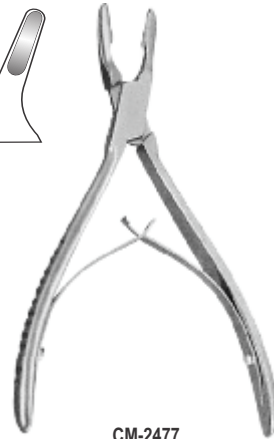

CM-2477
Friedmann
14 cm



Friedmann-Micro
15 cm



CM-2478

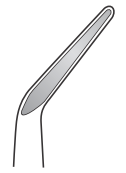

CM-2479



CM-2480

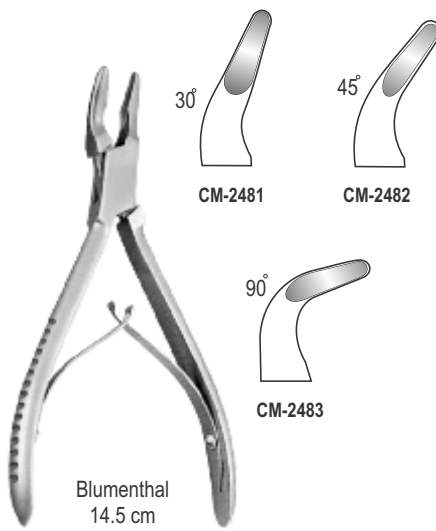

Blumenthal
14.5 cm

CM-2481

CM-2482

CM-2483



CM-2484
Bayer
18 cm



CM-2485
Max

Buccal tube convertible cap removing pliers cuts off the temporary cap on a convertible first molar buccal tube when banding of second molar is required

CM-2486
Spare blade
(2 Pieces)

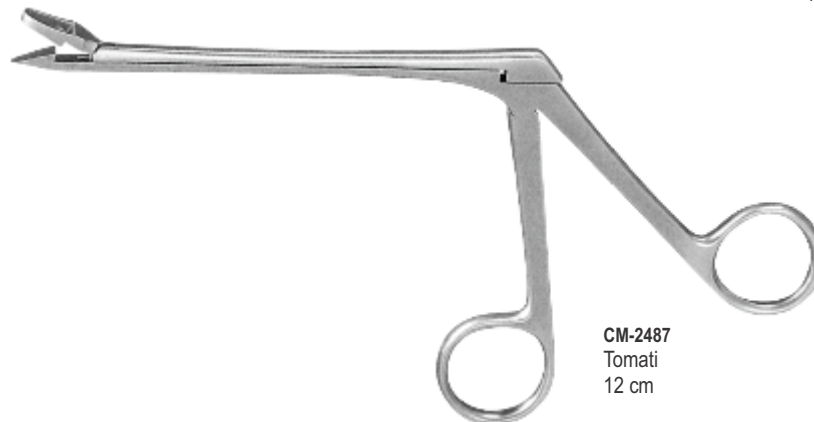

CM-2487
Tomati
12 cm



CM-2493
Set Of 5 Pcs



CARE MEDICAL[®]
SUPPLIES

Your health _ Our Priority

Section

05

Page 129-142

Dental
Surgery



inspiring
confidence in
health
care

www.caremedical.com.pk

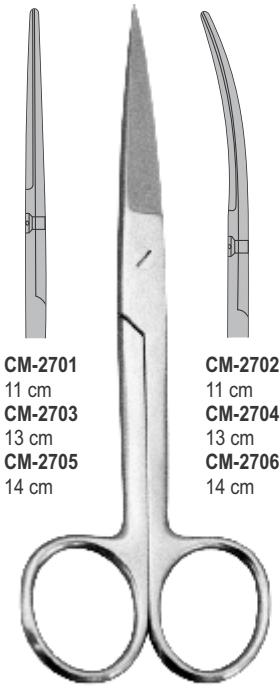

CM-2701
11 cm
CM-2703
13 cm
CM-2705
14 cm

CM-2702
11 cm
CM-2704
13 cm
CM-2706
14 cm

Standard
Sharp / Sharp

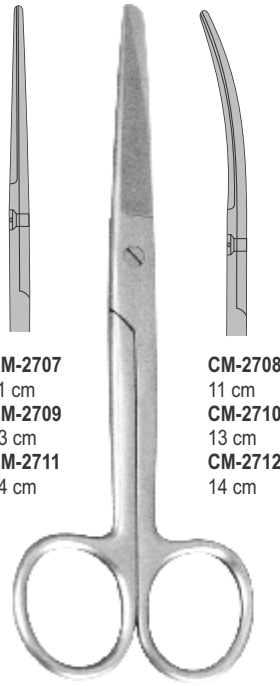

CM-2707
11 cm
CM-2709
13 cm
CM-2711
14 cm

CM-2708
11 cm
CM-2710
13 cm
CM-2712
14 cm

Standard
Blunt / Sharp

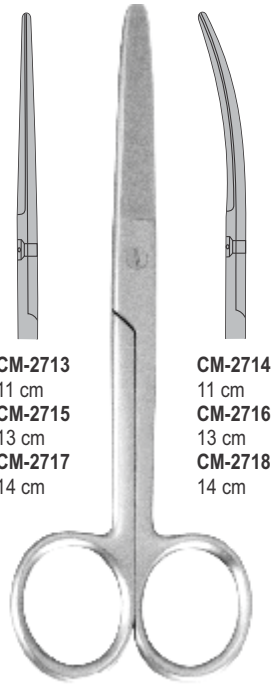

CM-2713
11 cm
CM-2715
13 cm
CM-2717
14 cm

CM-2714
11 cm
CM-2716
13 cm
CM-2718
14 cm

Standard
Blunt / Blunt

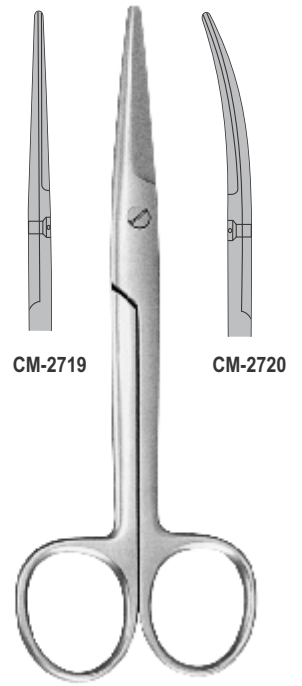

Mayo
14 cm

Suture Scissors | Tijeras para Hilos | Fadenscheren

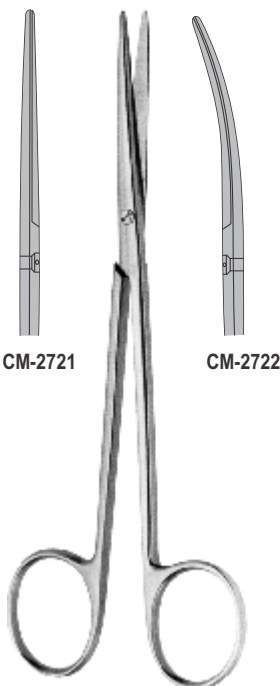

CM-2721

CM-2722

Metzenbaum-Delicate
14 cm

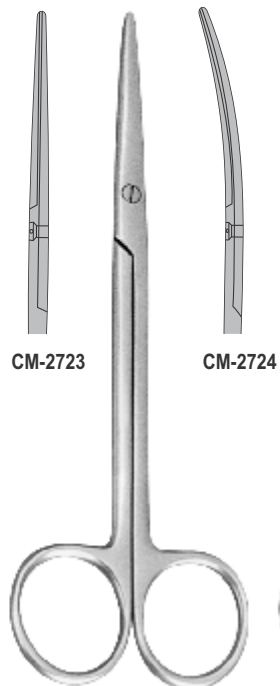

CM-2723

CM-2724

Metzenbaum
14 cm

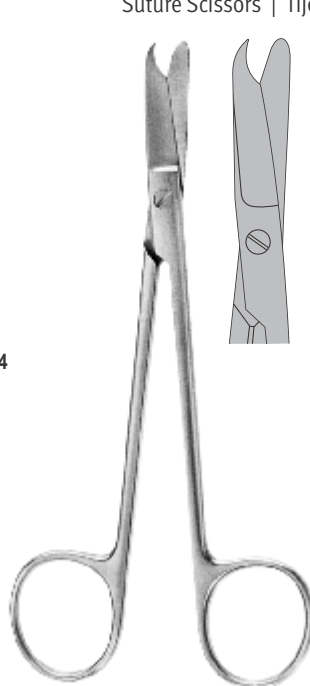

CM-2725
Littauer
14 cm

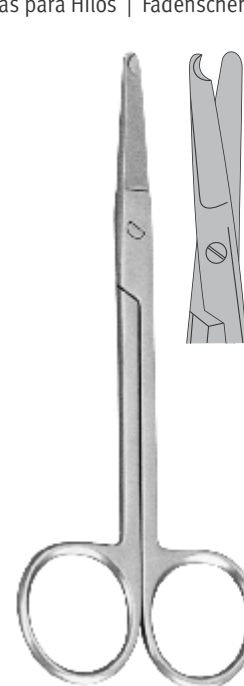

Spencer
CM-2726 9 cm
CM-2727 13 cm



Bandage Scissors Lister
CM-2728 9 cm
CM-2729 11 cm
CM-2730 14 cm
CM-2731 18 cm

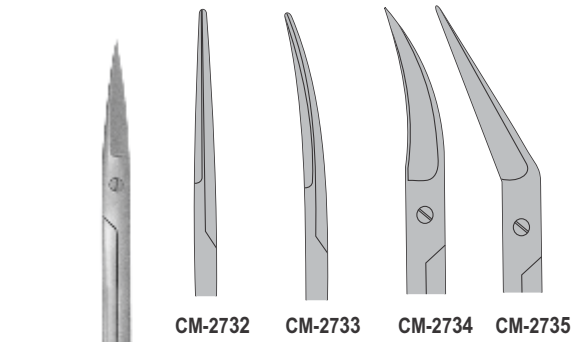

Iris
11 cm

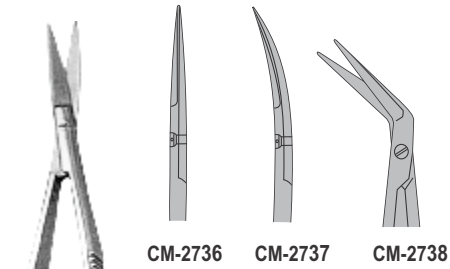

Noyes / Castroviejo
12 cm

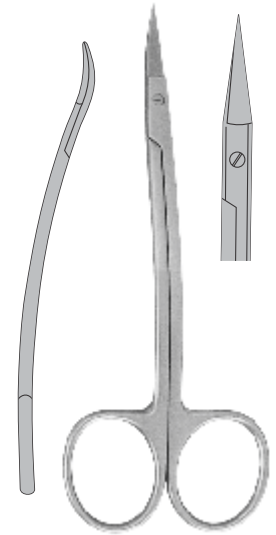

CM-2739
La Grange
11 cm



CM-2740
Universal
18 cm

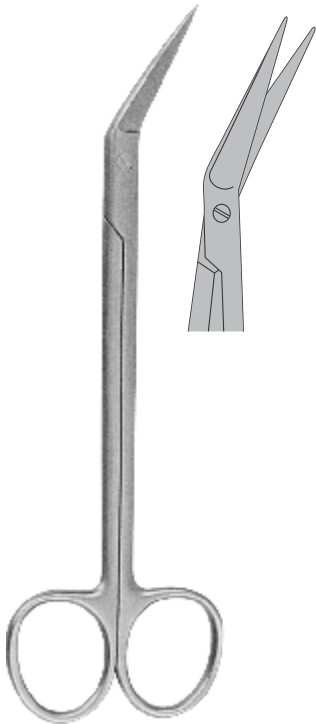

CM-2741
Kelly
16 cm

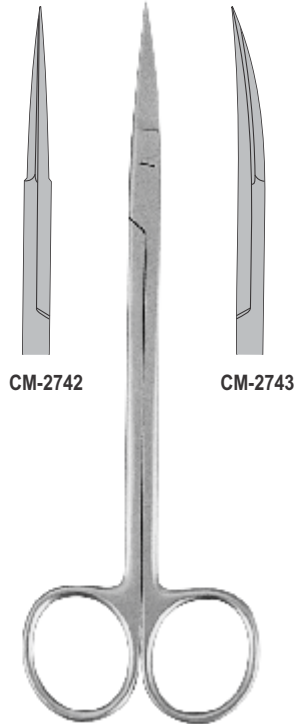

Kelly
16 cm



CM-2744
Goldman-Fox
13 cm

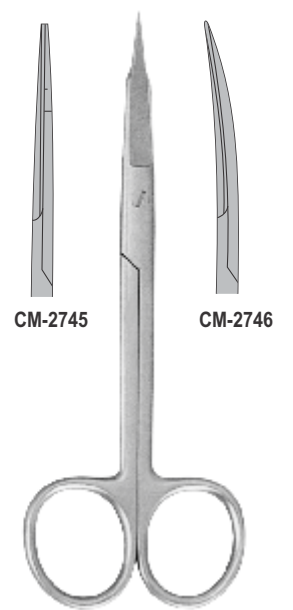

Goldman-Fox
13 cm

Scissors, One Blade Serrated

- One blade is with fine serrations to avoid tissue or ligature slippage.
- Manufactured from high quality stainless steel to provide longer-lasting cutting edge.
- Single black ring for easy identification.



Iris
11 cm

CM-2747

CM-2748

CM-2749

CM-2750



CM-2751

Goldman-Fox
13 cm

CM-2752
Goldman-Fox
13 cm

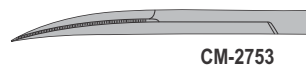

CM-2753

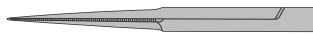

CM-2754

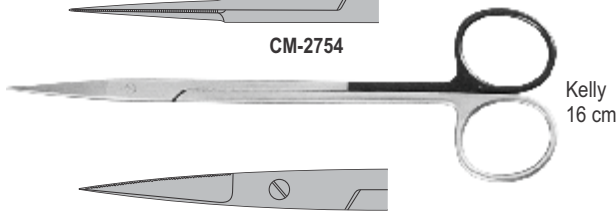

Kelly
16 cm



CM-2755
Locklin
16 cm

CM-2756
Locklin
16 cm

Super-Cut

- Cutting Blade horned to "razor" sharpness with opposing blade finished with fine serrations to avoid tissue slippage.
- Extremely smooth cutting with less trauma.
- Manufactured from high quality stainless steel to provide longer-lasting cutting edge.
- Single gold plated ring for easy identification.

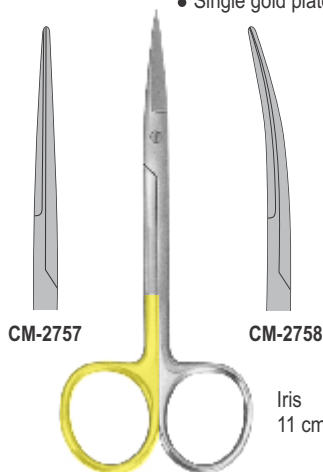

CM-2757

CM-2758

Iris
11 cm



CM-2759
La Grange
11 cm

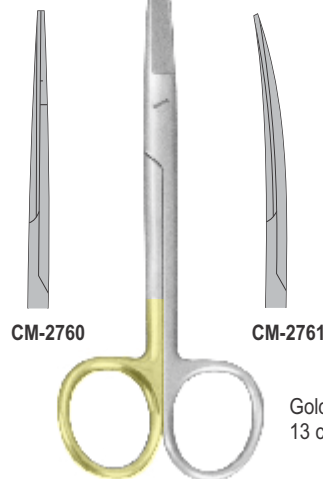

CM-2760

CM-2761

Goldman-Fox
13 cm

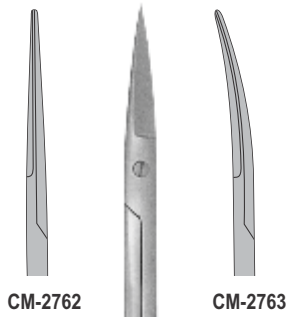

Iris
11 cm

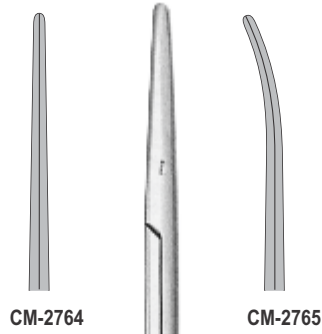

Metzenbaum
14 cm

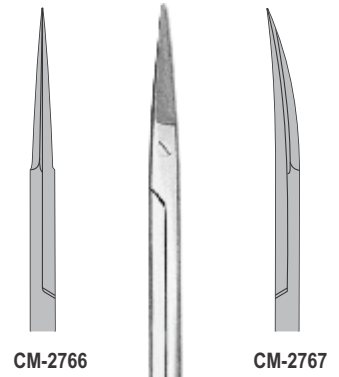

Kelly
16 cm

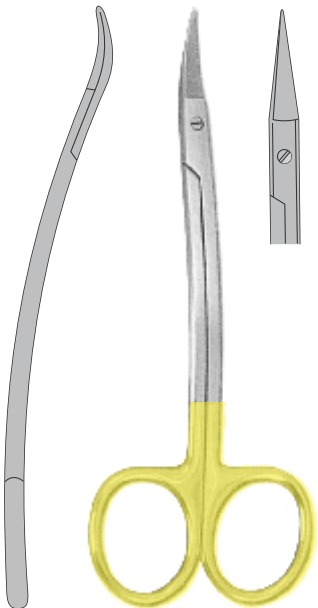

CM-2768
La Grange
11 cm

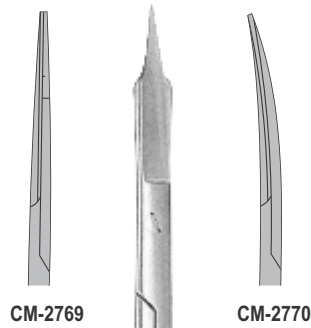

Goldman-Fox
13 cm

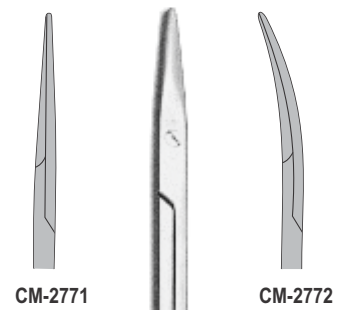

Strabismus
11 cm



Micro Scissor
Stainless Steel

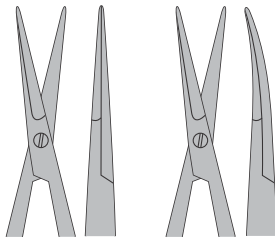

CM-2773
15 cm

CM-2774
15 cm



Micro Scissor
Stainless Steel

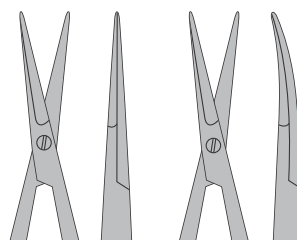

CM-2775
18 cm

CM-2776
18 cm



Micro Scissor
Stainless Steel
for ligature, one blade serrated

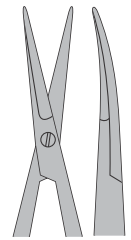

CM-2777
18 cm

Micro Scissors with Titanium Stainless Steel Tips

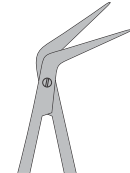

CM-2778
18 cm

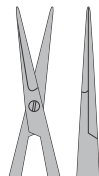

CM-2779
18 cm

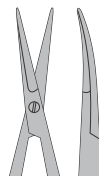

CM-2780
18 cm

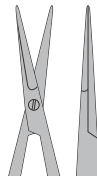

CM-2781
15 cm

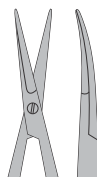

CM-2782
15 cm



CM-2783
Micro Scissor
12cm Straight



CM-2784
Micro Scissor
12cm Curved

Tweezers

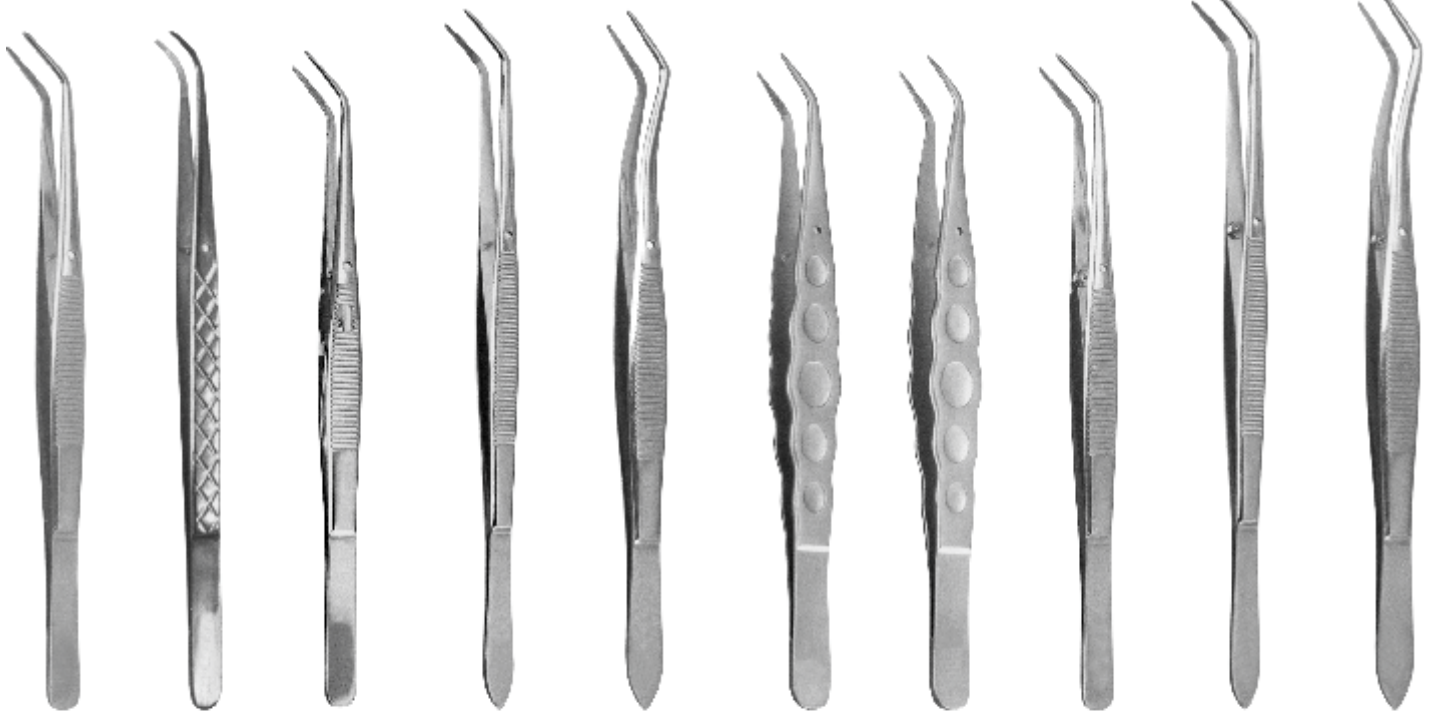

CM-2785 College 15 cm	CM-2786 College 15 cm	CM-2787 College-Locking 15 cm	CM-2788 Flagg 16 cm	CM-2789 Meriam 16 cm	CM-2790 College 15 cm	CM-2791 Meriam 15 cm	CM-2792 College 15 cm	CM-2793 Flagg 16 cm	CM-2794 Meriam 16 cm
------------------------------------	------------------------------------	--	----------------------------------	-----------------------------------	------------------------------------	-----------------------------------	------------------------------------	----------------------------------	-----------------------------------

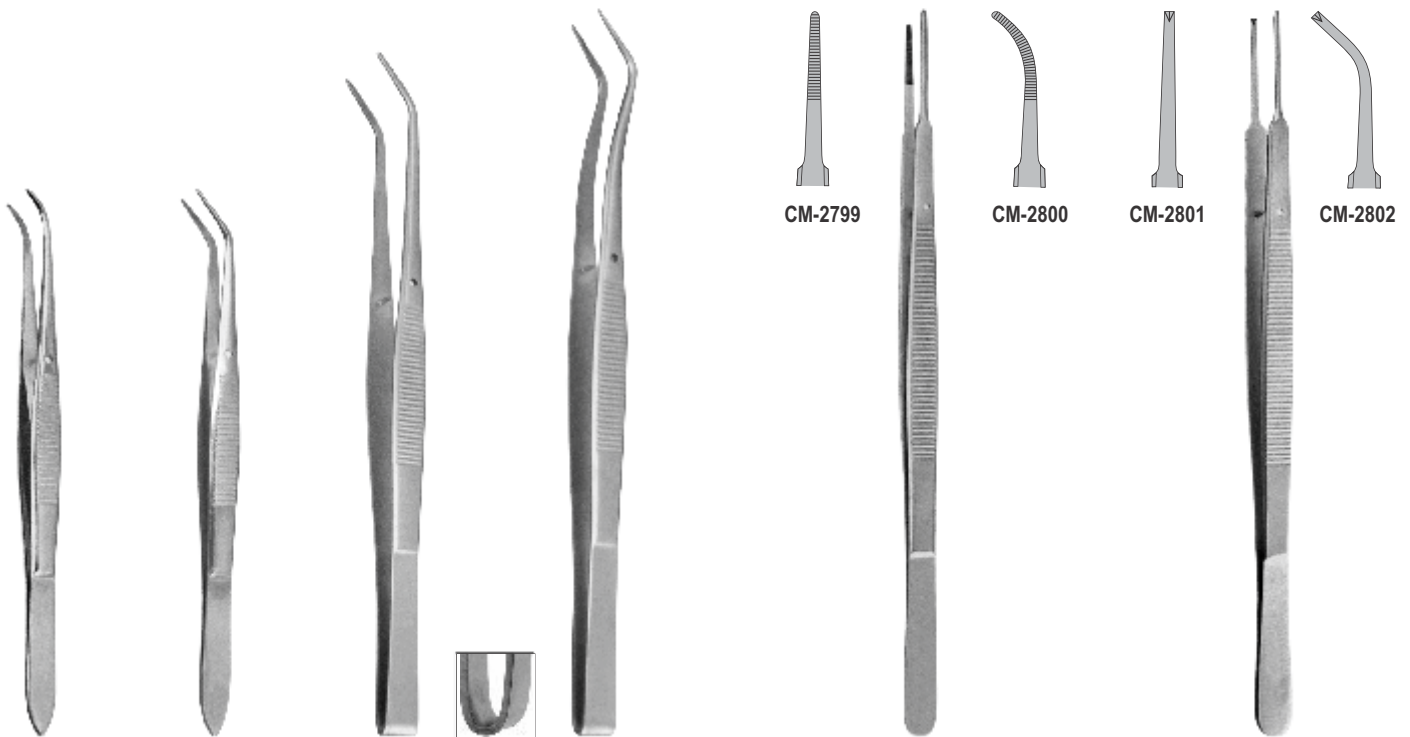

CM-2795 Perry 13 cm	CM-2796 Perry 13 cm	CM-2797 College TOE 15 cm	CM-2798 Meriam TOE 16 cm	CM-2799	CM-2800	CM-2801	CM-2802	Gerald 18 cm	Gerald 18 cm
----------------------------------	----------------------------------	--	---------------------------------------	----------------	----------------	----------------	----------------	------------------------	------------------------

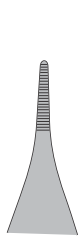

CM-2803
12 cm



Adson

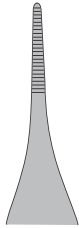

CM-2804
15 cm

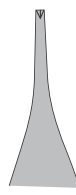

CM-2805
12 cm



Adson
1x2

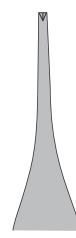

CM-2806
15 cm

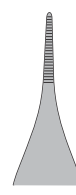

CM-2807
12 cm



Micro Adson

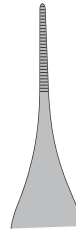

CM-2808
15 cm

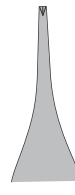

CM-2809
12 cm



Micro Adson
1x2

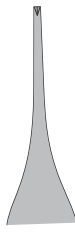

CM-2810
15 cm

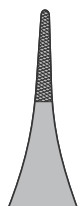

CM-2811



Adson with
Tungsten Carbide
12 cm

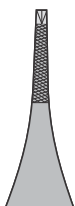

CM-2812
1x2



CM-2813



DeBakey
Atraumatic
16 cm

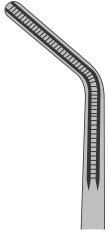

CM-2814



CM-2815



Iris
10 cm



CM-2816



CM-2817
1x2



Iris
10 cm



CM-2818
1x2



CM-2819
11 cm

Fig. 2



CM-2820
11 cm

Fig. 3



CM-2821
11 cm

Fig. 4



CM-2822
11 cm

Fig. 5



CM-2823
11 cm

Fig. 5A



CM-2824
11 cm

Fig. 7



CM-2825



Semken
12.5 cm



CM-2826

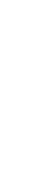

CM-2827
1x2



Semken
12.5 cm

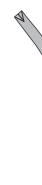

CM-2828
1x2

Micro Forceps



CM-2829
10 cm

CM-2830
11 cm

CM-2831
13 cm

CM-2832
14 cm

CM-2833
15 cm

CM-2834
16 cm

CM-2835
18 cm

CM-2836
20 cm

CM-2837
25 cm

CM-2838
30 cm

Standard Dressing Forceps



CM-2839
10 cm

CM-2840
11 cm

CM-2841
13 cm

CM-2842
14 cm

CM-2843
15 cm

CM-2844
16 cm

CM-2845
18 cm

CM-2846
20 cm

CM-2847
25 cm

CM-2848
30 cm

Standard Dissecting Forceps

Tissue Forceps

Splinter Forceps

Towel Forceps



CM-2849
Adson-Brown
12 cm

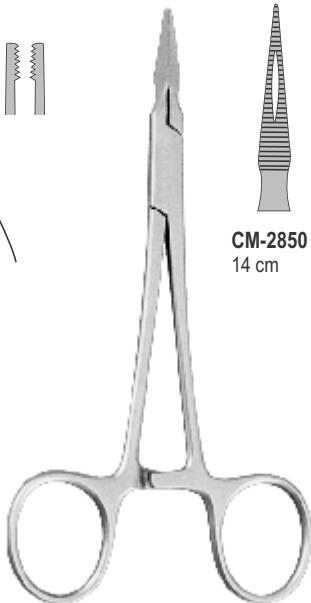
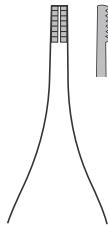

Stieglitz



CM-2850
14 cm

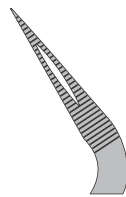

CM-2851
13.5 cm



CM-2852
12.5 cm



Backhaus
CM-2853 9 cm
CM-2854 11 cm
CM-2855 13 cm



CM-2856
Jones
9 cm



CM-2857
Schaedel
9 cm

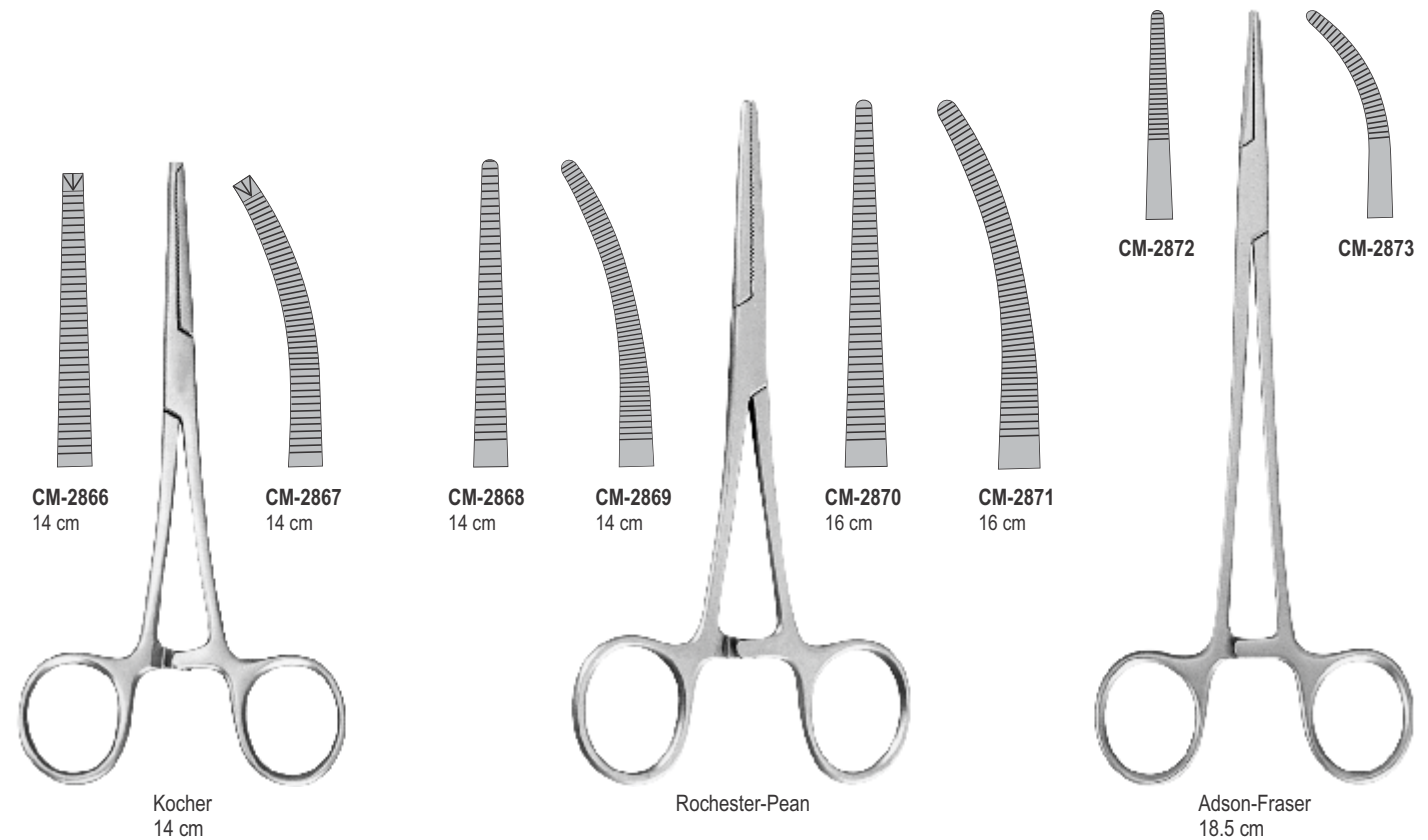

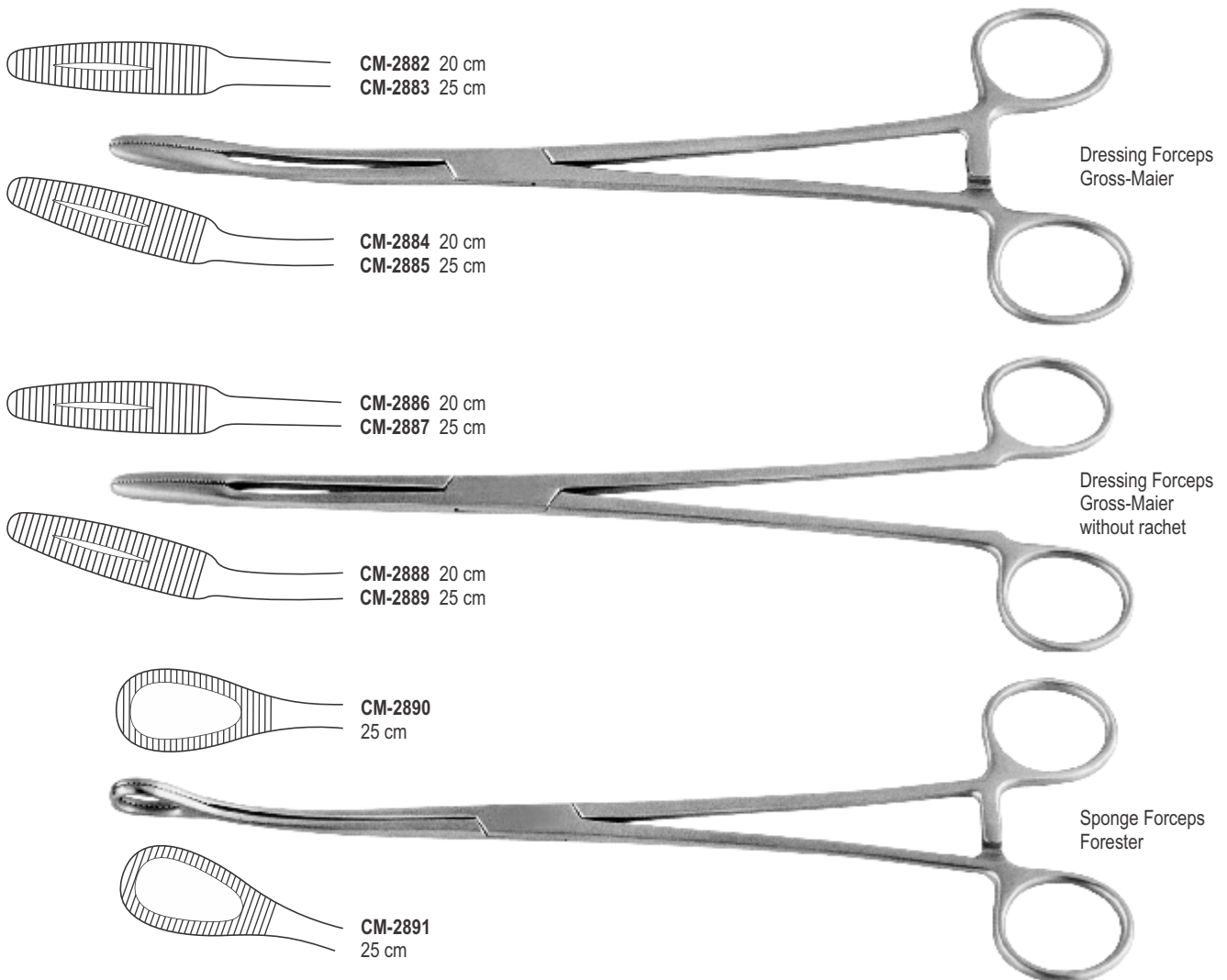



CM-2892
Derf
12.5 cm

CM-2893
Olsen-Hegar
with scissor
14 cm

CM-2894
Baumgartner
14.5 cm

CM-2895
Crilewood
15 cm

Mayo-Hegar
CM-2896 14 cm
CM-2897 15 cm
CM-2898 16 cm
CM-2899 18 cm
CM-2900 20 cm

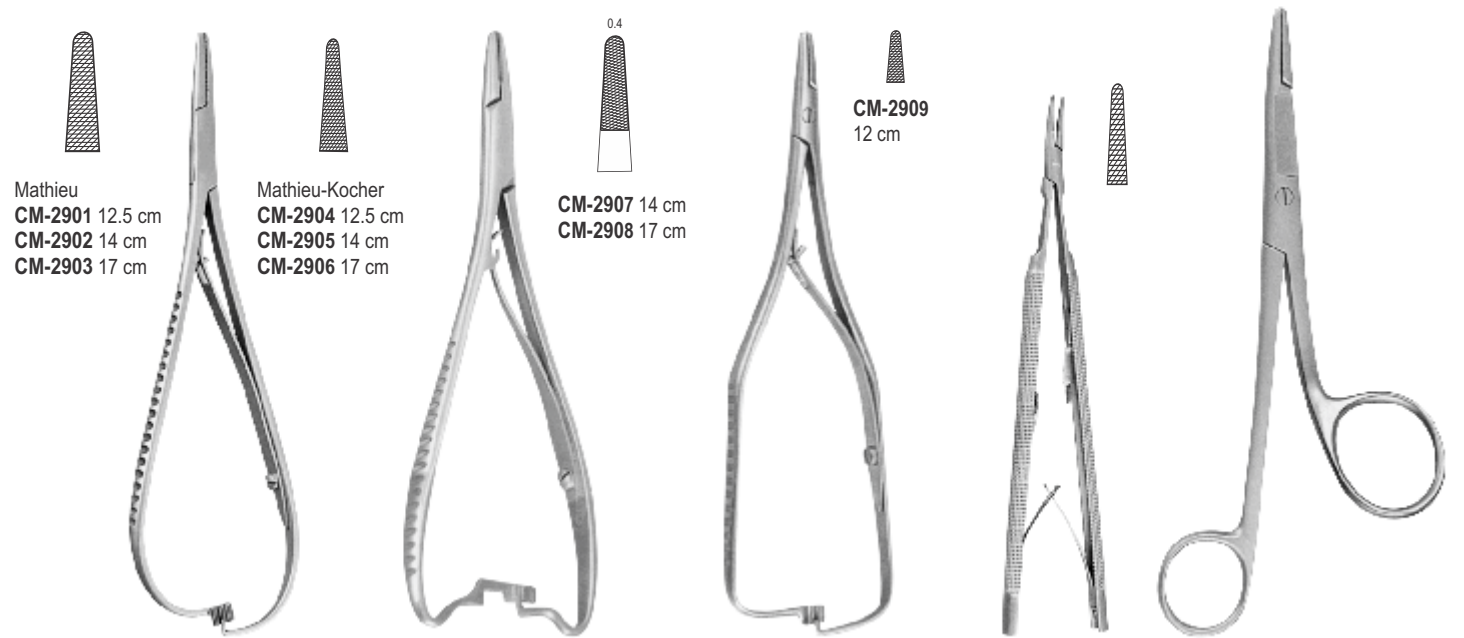

Mathieu
CM-2901 12.5 cm
CM-2902 14 cm
CM-2903 17 cm

Mathieu-Kocher
CM-2904 12.5 cm
CM-2905 14 cm
CM-2906 17 cm

CM-2907 14 cm
CM-2908 17 cm

CM-2909
12 cm

CM-2910
Castroviejo
13 cm

Gillies with Scissor 16 cm
CM-2911 Left handed
CM-2912 Right handed

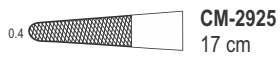
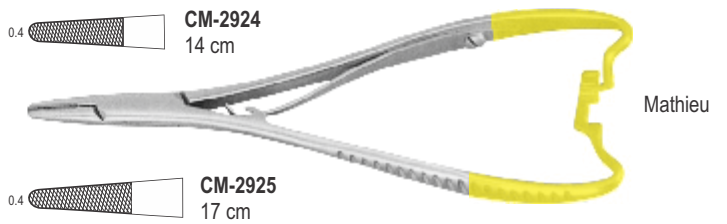
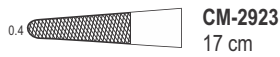
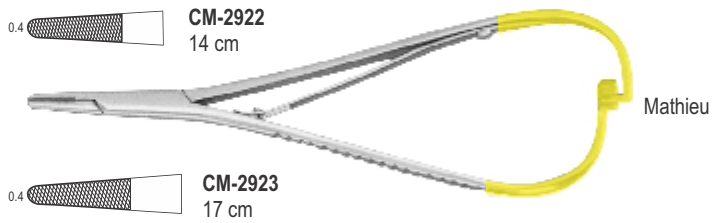
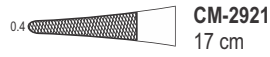
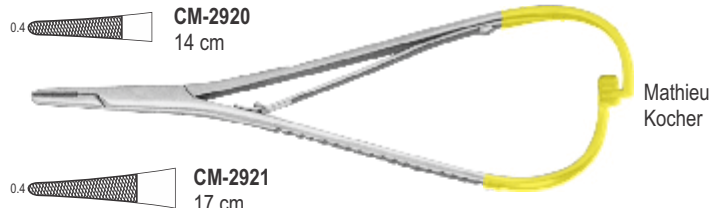
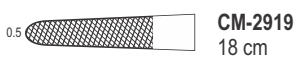
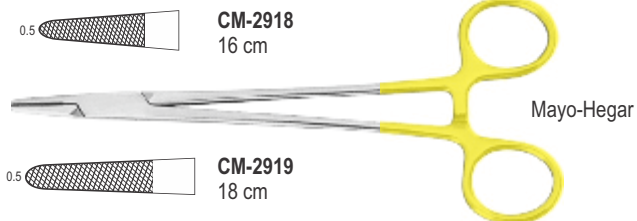
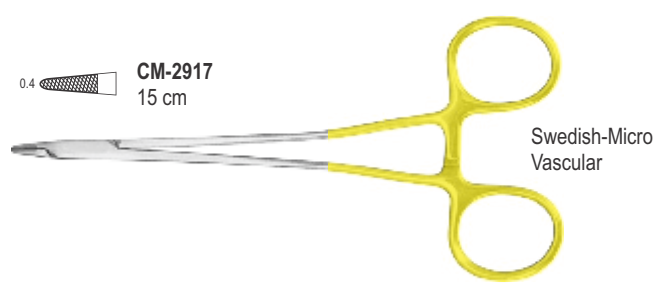
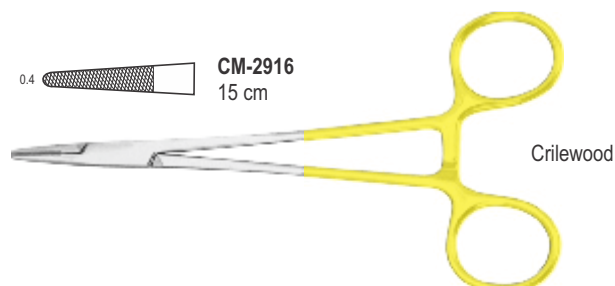
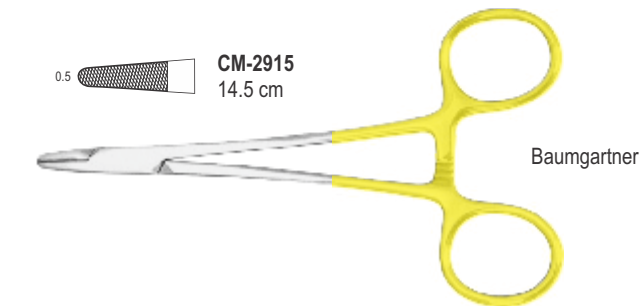
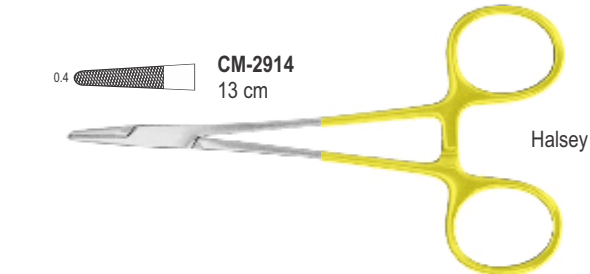
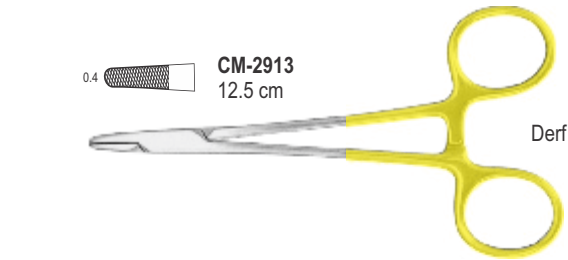

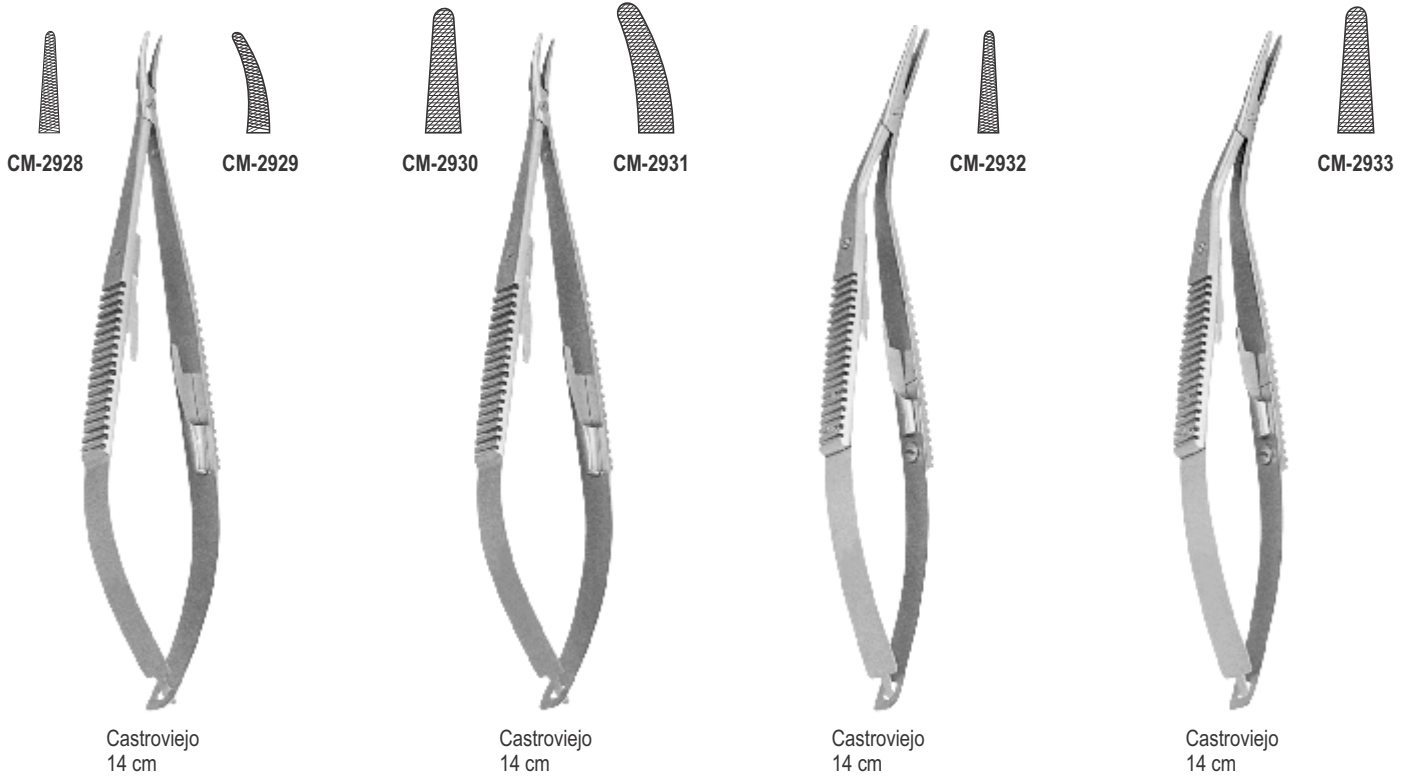

Needle Holders with Tungsten Carbide inserts

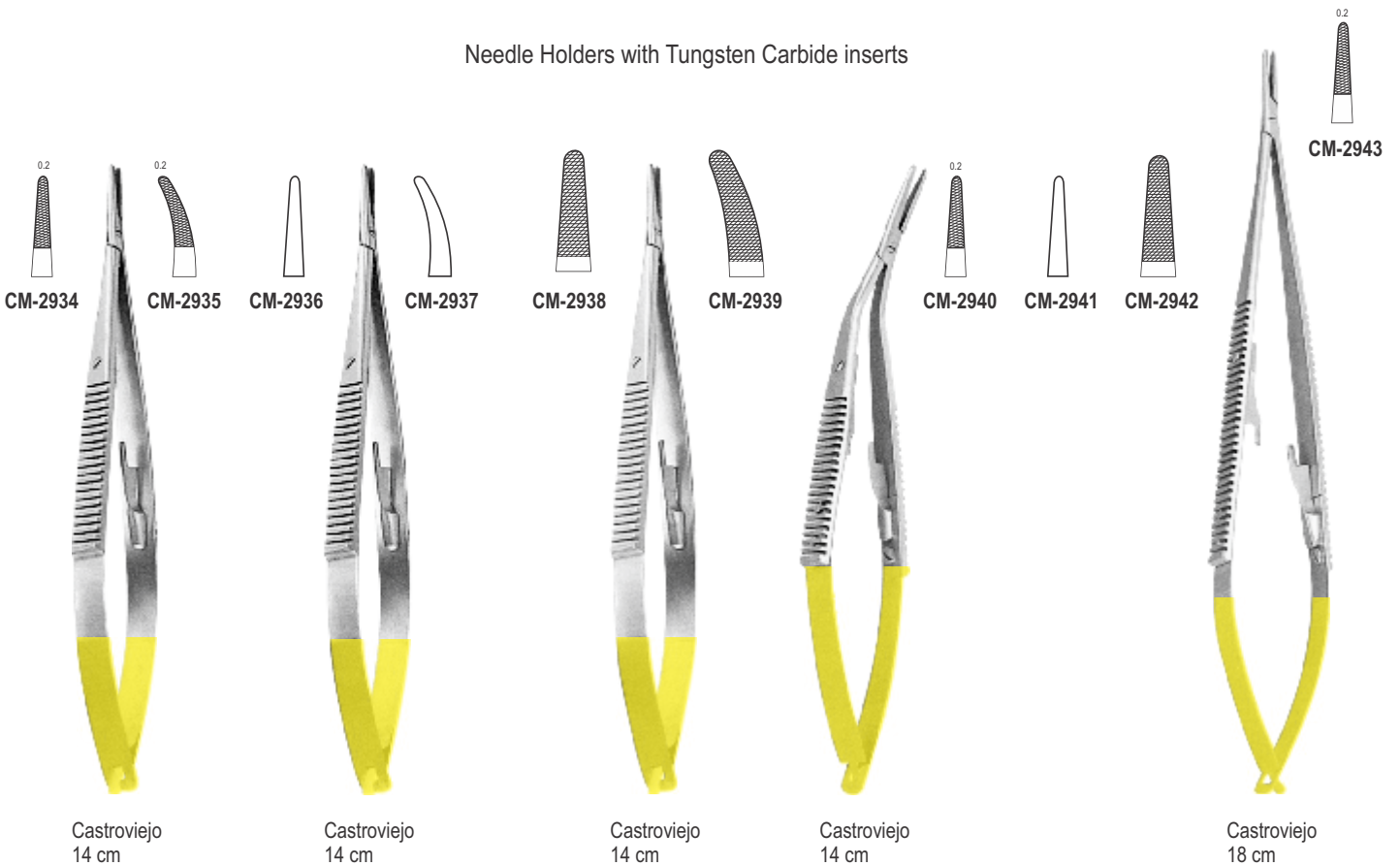

Micro Needle Holders Stainless Steel

Micro Needle Holders Stainless Steel with Tungsten Carbide Inserts

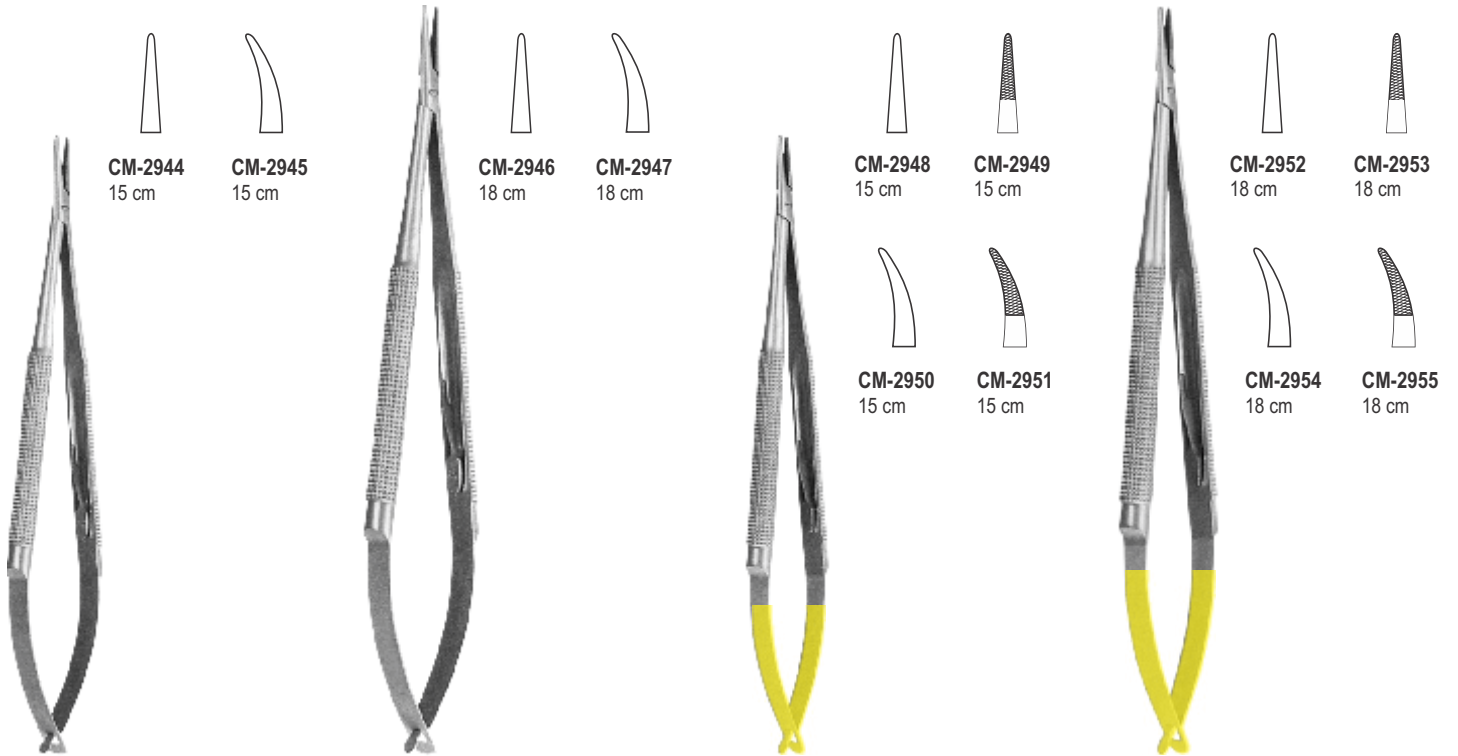

Micro Forceps Stainless Steel

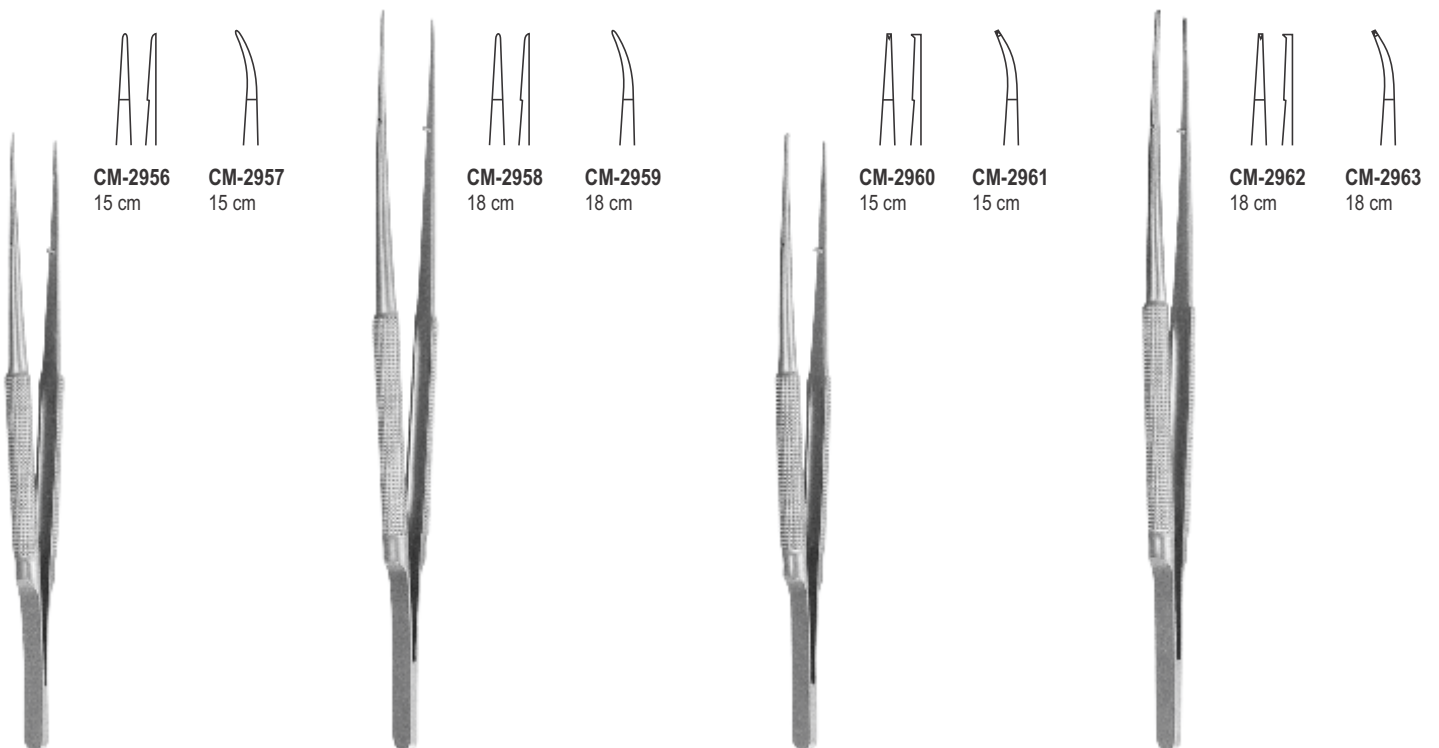



CARE MEDICAL[®]
S U P P L I E S

Your health _ Our Priority

Section

06

Page 143-146

Impression
Tray

inspiring
confidence in
health
care

www.caremedical.com.pk

All Impression Trays Upper & Lower Type are available in S, M, L & XL Sizes

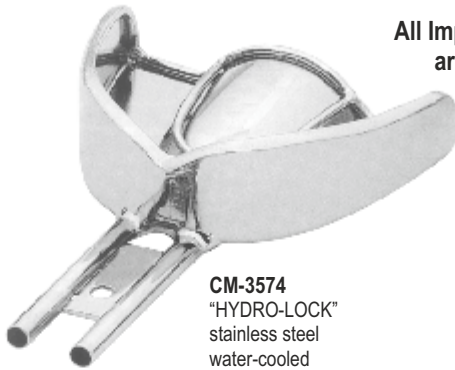

CM-3574
"HYDRO-LOCK"
stainless steel
water-cooled
impression trays
with retention rim.

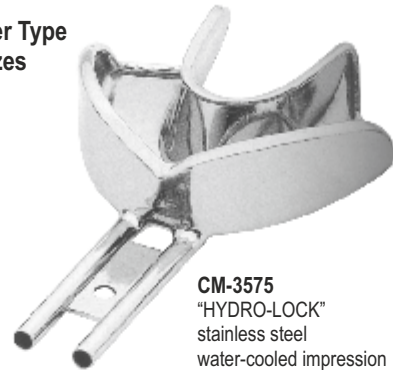

CM-3575
"HYDRO-LOCK"
stainless steel
water-cooled impression
trays with retention rim.



CM-3576
"NEW SUPER"
stainless steel
impression trays
with retention rim.



CM-3577
"NEW SUPER" stainless
steel impression trays
with retention rim.



CM-3578
"ANATOMIC" solid
regular stainless
steel impression
trays without
retention rim.



CM-3579
"ANATOMIC" solid regular
stainless steel impression
trays without retention rim.

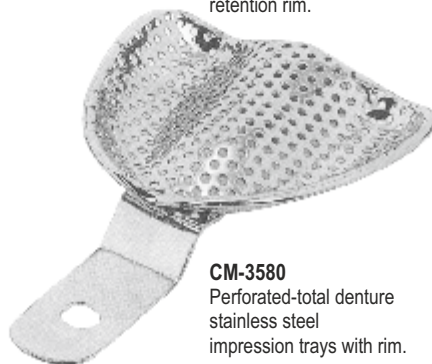

CM-3580
Perforated-total denture
stainless steel
impression trays with rim.



CM-3581
Perforated-total denture
stainless steel
impression trays with rim.

All Impression Trays Upper & Lower Type are available in S, M, L & XL Sizes



CM-3582
"PERMA-LOCK" solid regular stainless steel impression trays with retention rim.



CM-3583
"PERMA-LOCK" solid regular stainless steel impression trays with retention rim.



CM-3584



CM-3585



CM-3586



CM-3587



CM-3588



CM-3589



CM-3590
Set of six

PACKINGS



CM-3591
Set of Eight



CM-3592
Solid stainless steel anterior depressed impression trays with retention rim.



CM-3593



CM-3594



CM-3595



CM-3596



CM-3597



CM-3598



CM-3599
Solid stainless steel anterior depressed impression trays with retention rim.

All Impression Trays Upper & Lower Type
are available in S, M, L & XL Sizes

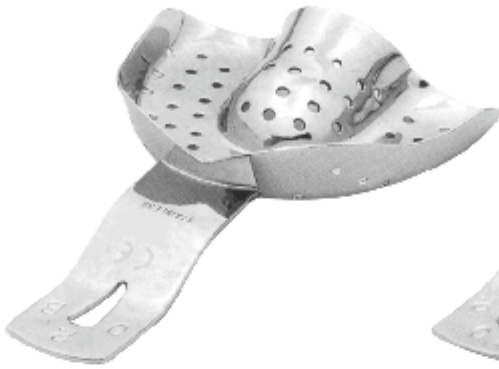

CM-3600
Fig. 0 per bambini - for children

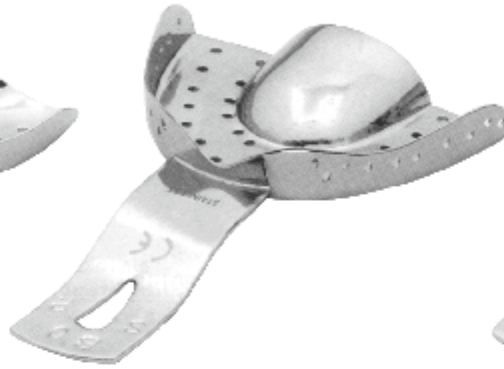

CM-3601
For narrow toothed upper jaws



CM-3602
Fig. 0 per bambini - for children



CM-3603
For partially toothed upper jaws



CM-3604
For partially toothed lower jaws



CM-3605
For edentulous upper jaws



CM-3606
For edentulous lower jaws

All Impression Trays Upper & Lower Type are available in S, M, L & XL Sizes



CM-3607
Solid total denture stainless steel impression tray with rim.

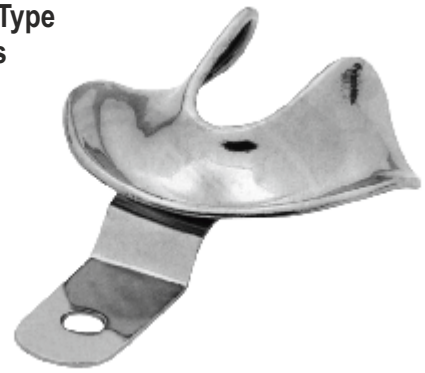

CM-3608
Solid total denture stainless steel impression tray with rim.



CM-3609
"PERMA-LOCK" perforated regular stainless steel impression trays with retention rim.



CM-3610
"PERMA-LOCK" perforated regular stainless steel impression trays with retention rim.



CM-3611
Perforated stainless steel anterior depressed impression trays with retention rim.

CM-3612



CM-3613



CM-3614



CM-3615



CM-3616



CM-3617



CM-3618
Perforated stainless steel anterior depressed impression trays with retention rim.



CM-3619
Perforated stainless steel impression trays without retention rim for complete denture.



CM-3620
Perforated stainless steel impression trays without retention rim for complete denture.



CARE MEDICAL[®]
SUPPLIES

Your health _ Our Priority

Section

07

Page 145-149

Rubber Dam Instruments

inspiring
confidence in
health
care

www.caremedical.com.pk

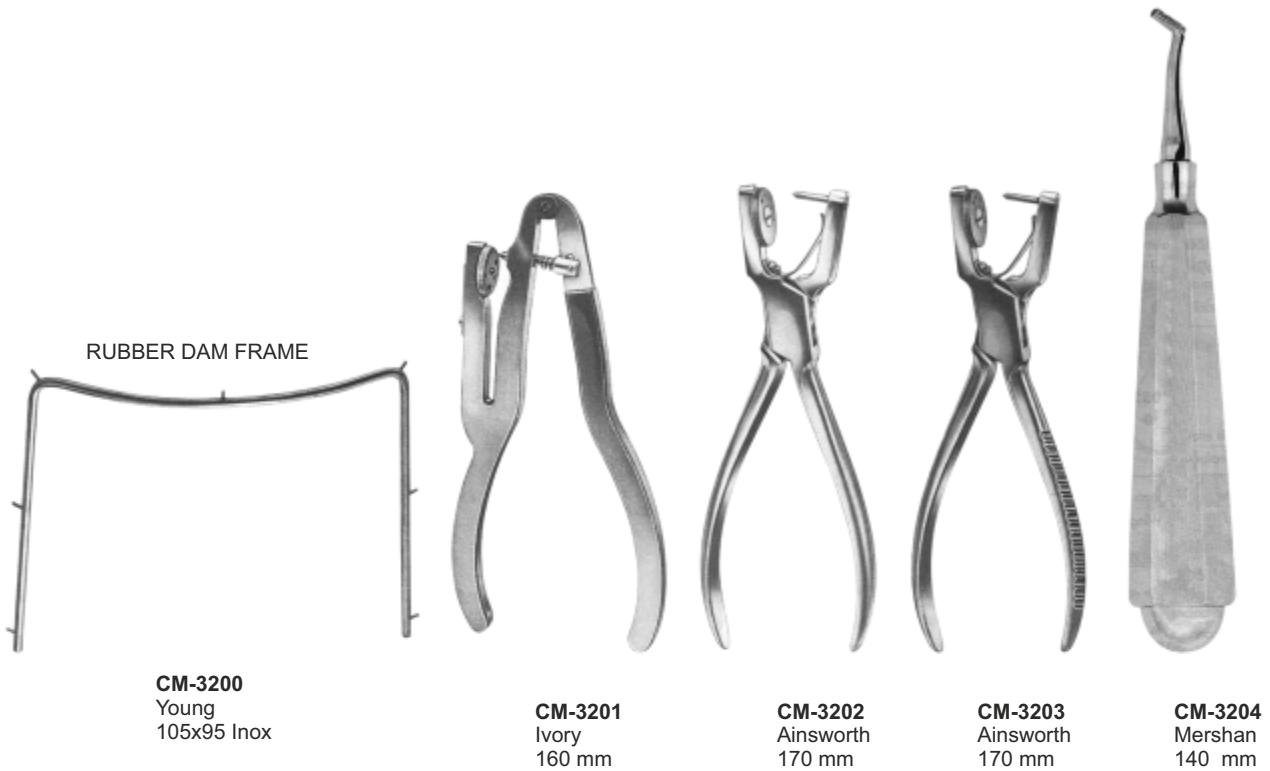

CLAMPS (PLIERS)

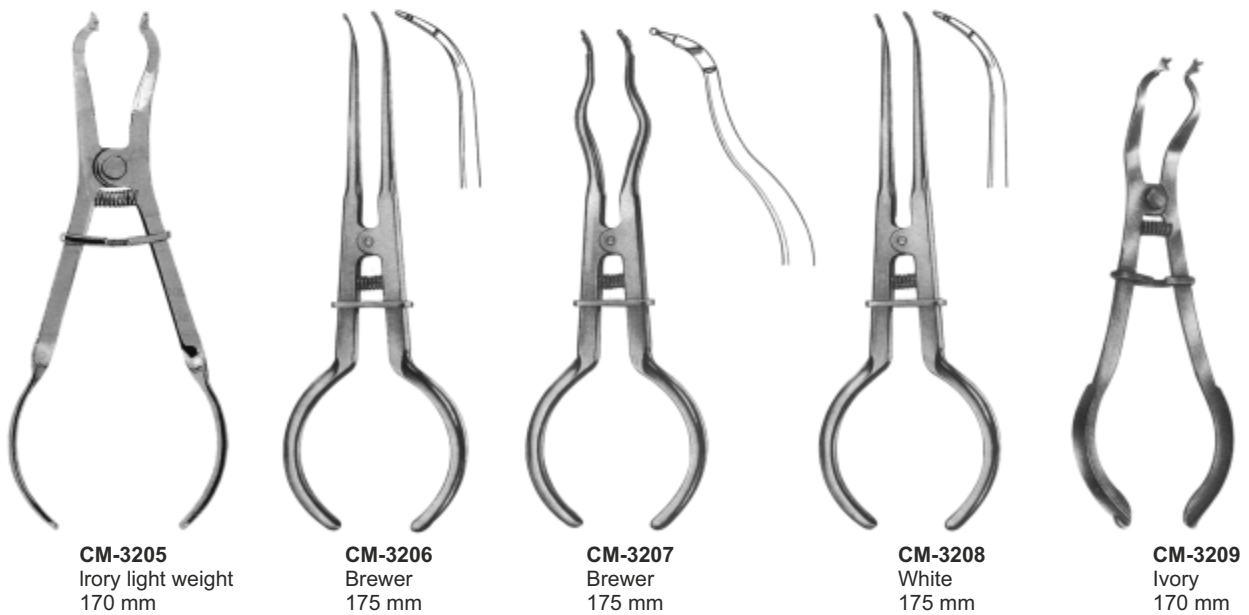



CM-3210 - 9
Winged
Labial Clamp



CM-3211 - 9T
Winged
Edged Labial Clamp



CM-3212 - 212
Winged
Cervical Clamp



CM-3213 - 210
Winged
Labial Clamp

Premolars



CM-3214 - 00
Winged



CM-3215 - 0
Winged



CM-3216 - WO
Wingless

For Small Teeth, Elongated or With Narrow Collars



CM-3217 - 1
Winged



CM-3218 - 1T
Winged



CM-3219 - W1
Wingless

For General Use With Adjustable Jaws According To Gingival Line Shapes



CM-3220 - 2A
Winged



CM-3221 - 2AT
Edged, Winged



CM-3222 - W2A
Wingless

For Premolars, With Elongated Collar



CM-3223 - 2
Winged



CM-3224 - 2T
Edged, Winged



CM-3225 - W2
Wingless

For Premolars, With Elongated Collar



CM-3226 - 29
Wingless



CM-3227 - 60
Wingless



CM-3228 - 3
Winged



CM-3229 - W3
Wingless



CM-3230 - 4
Winged



CM-3231 - W4
Wingless

For Small Lower Molars

For Small Lower Molars With Round clamps



CM-3232 - 7
Winged



CM-3233 - W7
Wingless



CM-3234 - 8
Winged



CM-3235 - W8
Wingless

For Square Lower Molars

For Round Upper Molars



CM-3236 - 8A
Winged



CM-3237 - W8A
Wingless



CM-3238 - 12A
Winged



CM-3239 - 13A
Wingless

For Molar Roots

For Partially Broken Molars



CM-3240 - 14
Winged



CM-3241 - 14T
Edged Winged



CM-3242 - W14
Wingless



CM-3243 - 14A
Winged



CM-3244 - W14A
Wingless

For Round Molars, Partially Broken, Undersized or Inclined



CM-3245 - 26
Wingless



2246 - 51
Wingless



CM-3247 - 202
Winged



CM-3248 - 205
Winged



CM-3249
Ivory
63mm

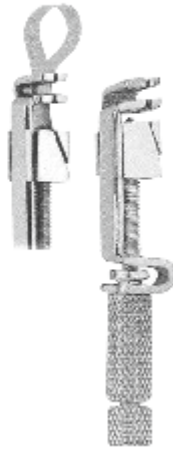

CM-3250
Tofflemire-Universal



CM-3251
Tofflemire-Junior



CM-3252
Tofflemire-Senior



CM-3253
Ivory 8
5 mm



CM-3254
Ivory 8
6 mm



CM-3255
Ivory 8
7 mm



CM-3256
Ivory 8 N



CM-3257
Didner 8 P



CM-3259



CM-3260



CM-3261

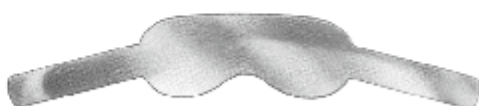

CM-3262

For Molars and Premolars



CM-3263



CM-3264



CM-3265



CM-3258

1750-5 mm x 100 cm
1750-6 mm x 100 cm
1750-7 mm x 100 cm

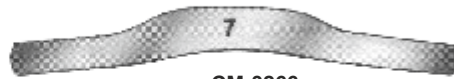

CM-3266
Molar
Fig 7

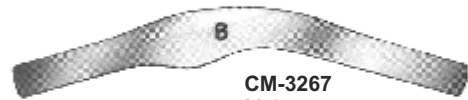

CM-3267
Molar
Fig 8



CM-3268
Molar
Fig 9

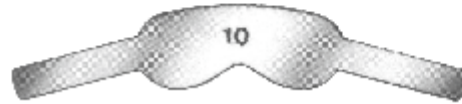

CM-3269
Molar
Fig 10



CM-3270
Tofflemire



CM-3271
Tofflemire



CM-3272
Tofflemire



CM-3273
Bicuspid



CM-3274
Bicuspid



CM-3275
Bicuspid



CM-3276
Bicuspid



CM-3277
Bicuspid



CM-3278
Bicuspid



CM-3282



CM-3279
Molar



CM-3280
Molar



CM-3281
Molars



CARE MEDICAL[®]
SUPPLIES

Your health _ Our Priority

Section

08

Page 150-159

Crown Removers

Rongeurs

inspiring
confidence in
health
care

www.caremedical.com.pk

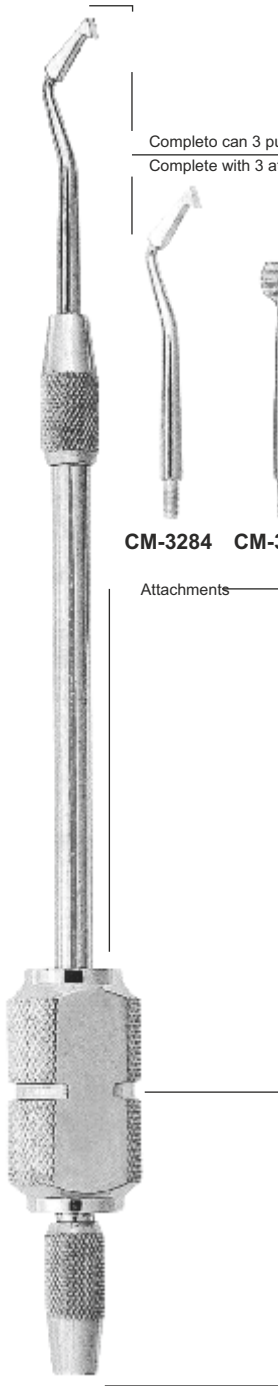

CM-3283

Completo can 3 punte
Complete with 3 attachments



CM-3284 CM-3285 CM-3286

Attachments



CM-3287

Crown Spreader, Crown Remove.
Special instrument for crown spreading
after separating, simple and safe
operation.

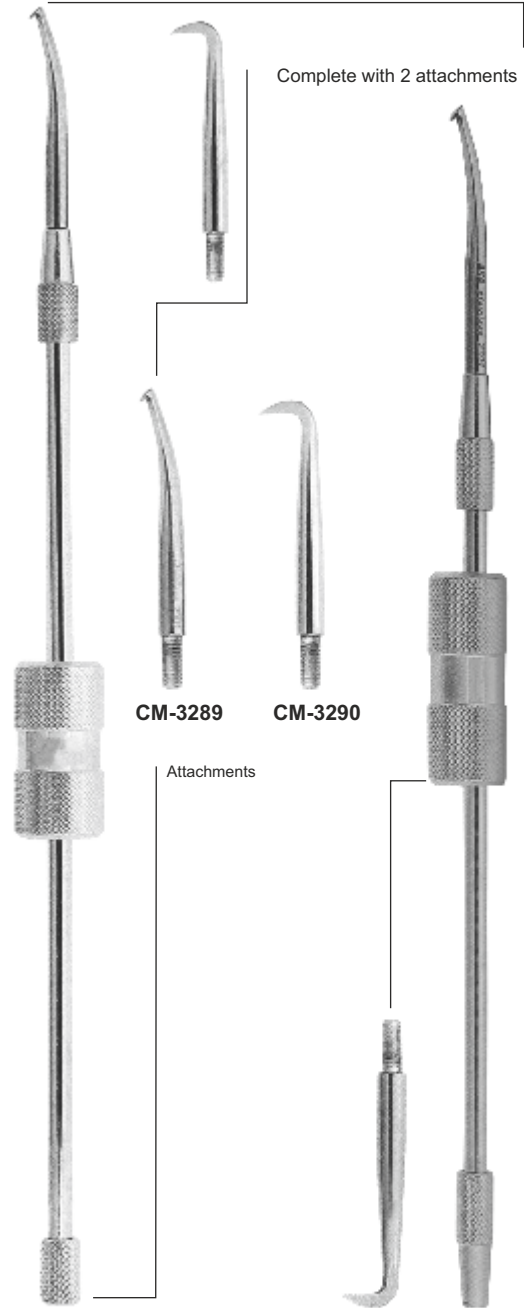

CM-3288

CM-3291

Completo with 2 attachments

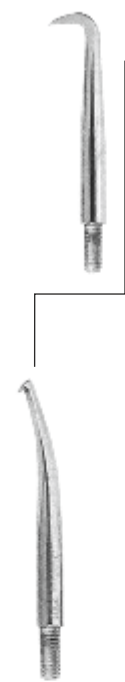

CM-3289 CM-3290

Attachments



Universal "HM"
12 cm, 4 3/4"

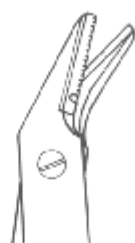

CM-3292

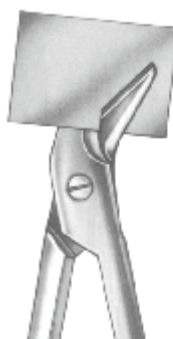

CM-3293



CM-3294
Beebe
10,5 cm, 4 1/8"



CM-3295
Merston



CM-3296
Morell



CM-3297
Morell



CM-3298
Morell



CM-3299
Morell



CM-3300
Treymann

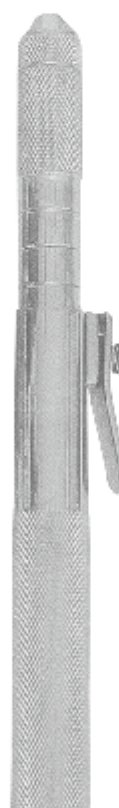

CM-3301
Automatic Crown Remover
With 2 Points



CM-3302



CM-3303



Copper ring removing pliers



CM-3315
Bohm
11,5 cm



CM-3316
Bohm
14,5 cm



CM-3317
Furrer
16 cm



CM-3318
Furrer
16 cm



CM-3319
Miller
15 cm



CM-3320
Miller
15 cm



CM-3321
Kelly
14 cm



CM-3322
Halstead-Mosquito
12 cm



CM-3323
Micro-Mosquito
10 cm

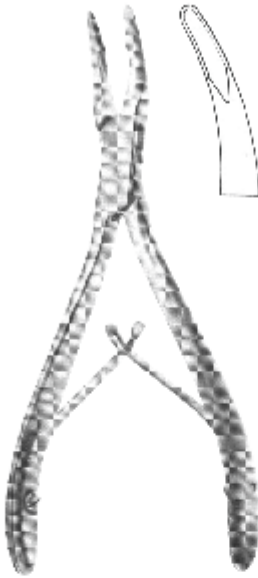

CM-3324
Friedmann
14 cm, 5 1/2"

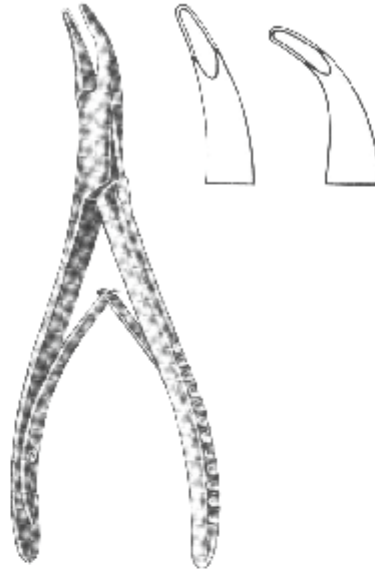

CM-3325
Mead
14 cm, 5 1/2"



CM-3326
Mead
14 cm, 5 1/2"

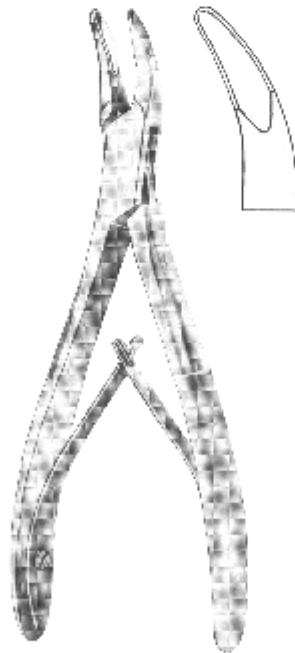

CM-3327
Mead
14 cm, 5 1/2"

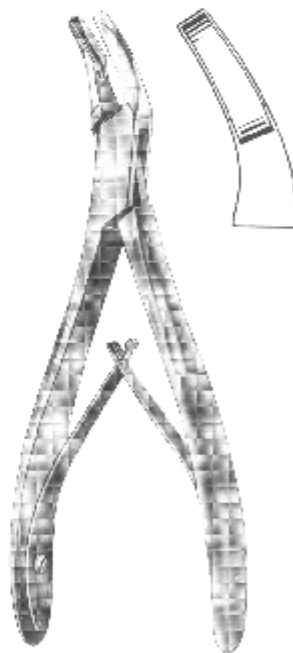

CM-3328
Mead
17 cm, 6 3/4"

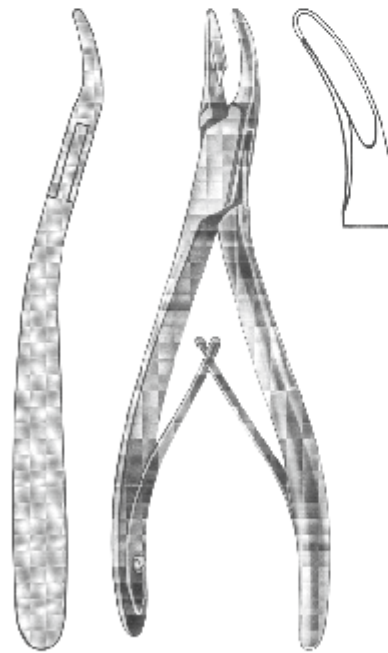

CM-3329
Schell
17 cm, 6 3/4"



CM-3330
Luer
15 cm



CM-3331
Friedman
14 cm



CM-3332
Mini Friedman
12 cm



CM-3333
Goldman-Fax
10 cm



CM-3334
Blumenthal
15 cm



CM-3335
Blumenthal 45
14,5 cm



CM-3336
Blumenthal 90
14 cm



CM-3337
Bohler
15 cm



CM-3338
Kerrison
15 cm

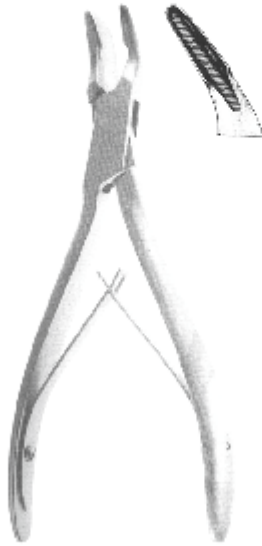

CM-3339
Blumenthal
16 cm, 6 1/4"

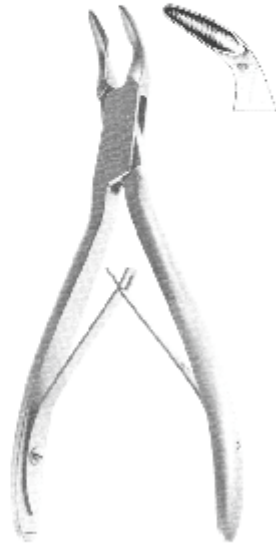

CM-3340
Blumenthal
16 cm, 6 1/4"

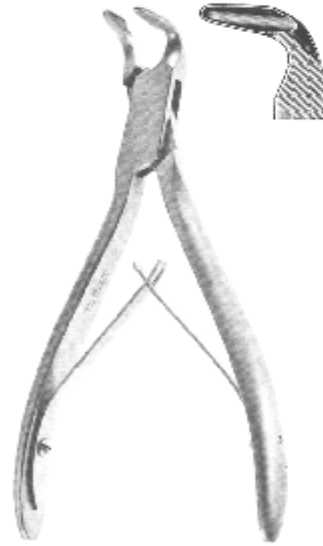

CM-3341
Blumenthal
16 cm, 6 1/4"

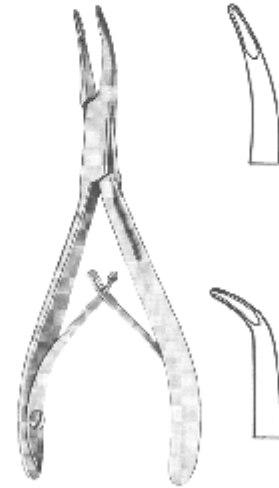

CM-3342
Kleinert-Kutz
14 cm, 5 1/2"

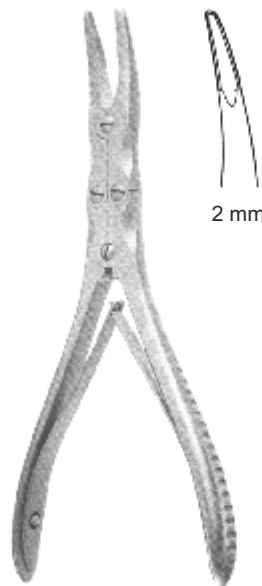

CM-3343
Ruskin-Mini
15 cm



CM-3344
Beyer
18 cm, 7 1/8"



CM-3345
Zaufal-Jansen
18 cm, 7 1/8"

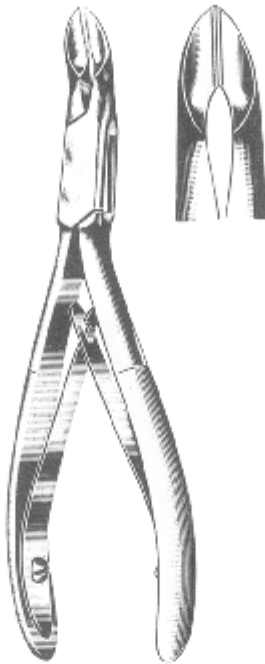

CM-3346
Niro
No. 5 S, 14 cm, 5 1/2"

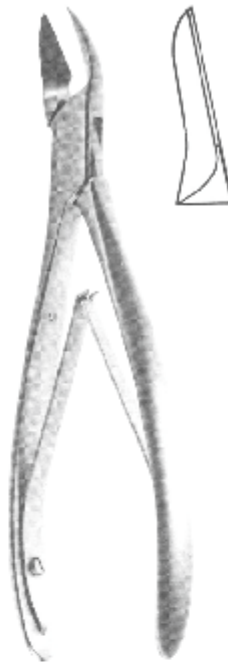

CM-3347
Cleveland
No. 5 S, 17 cm, 6 3/4"

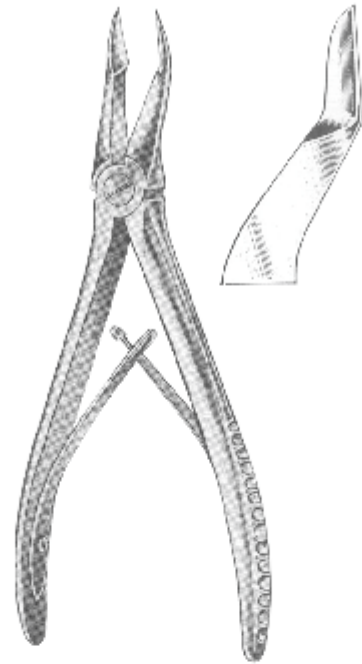

CM-3348
No. 18, 15 cm, 6"

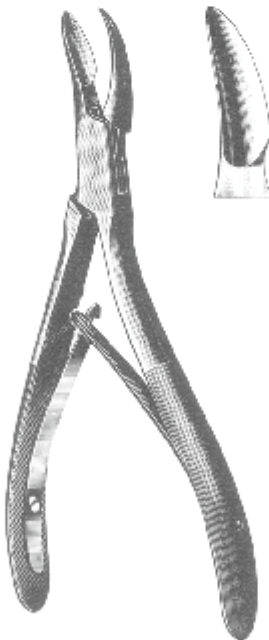

CM-3349
Cleveland
16 cm, 6 1/4"

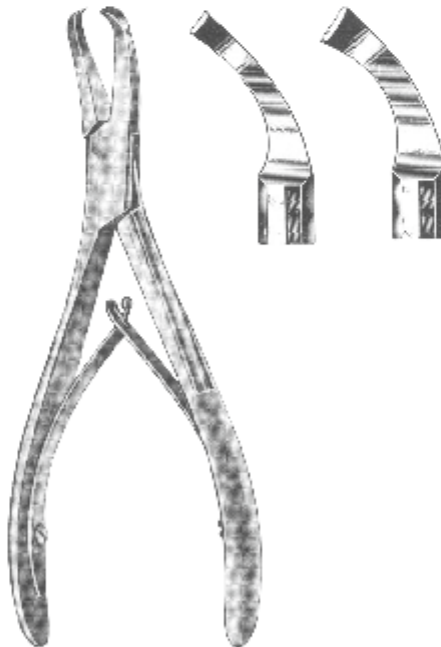

CM-3350
Gardner
16 cm, 6 1/4"

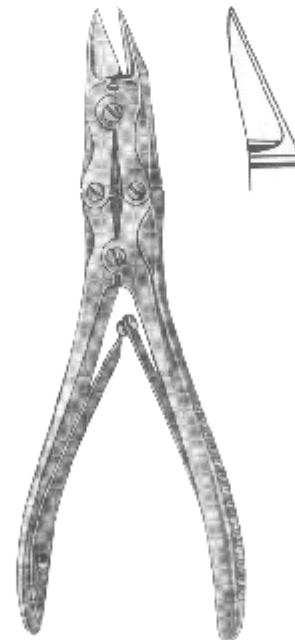

CM-3351
Liston-mini
15 cm, 6"



CM-3352
Williger
16 cm, 6 1/4"

CM-3353
Henahan
17 cm, 6 3/4"

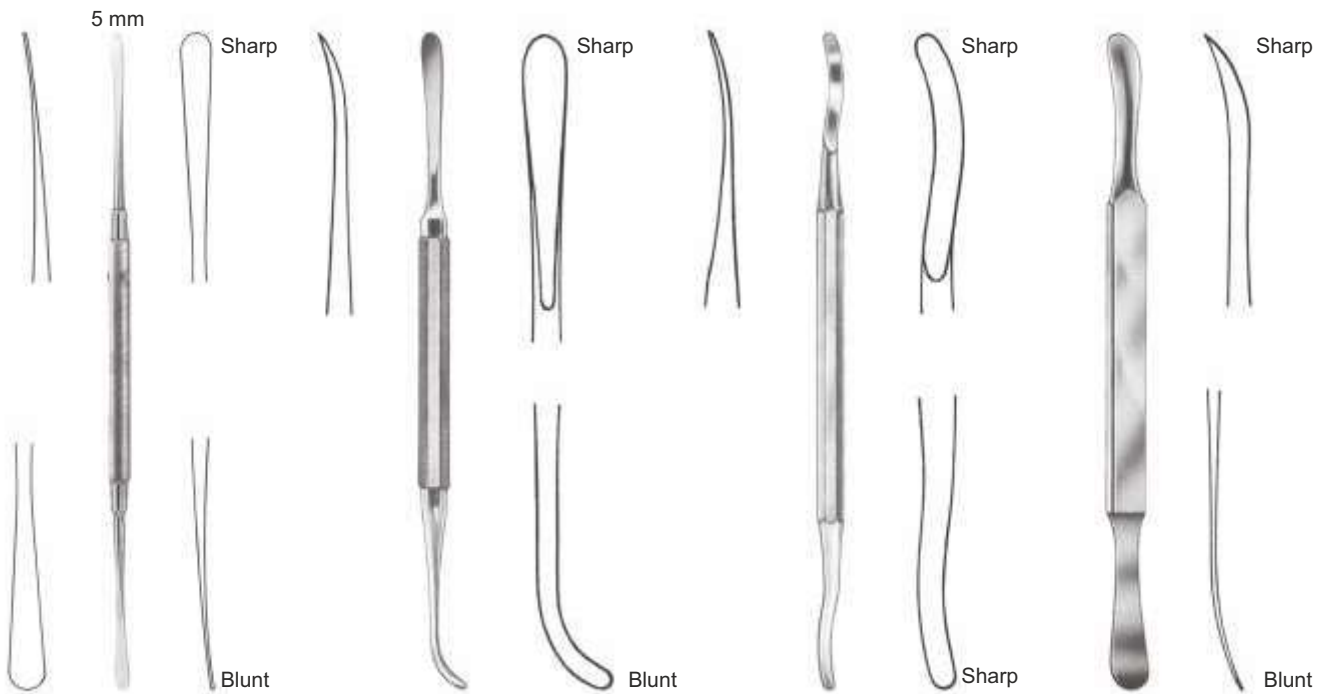

CM-3354
Freer
19 cm, 7 1/2"

CM-3355
Bennet
17 cm, 6 3/4"

CM-3356
Seldin
19 cm, 7 1/2"

CM-3357
Seldin
19,5 cm, 7 3/4"

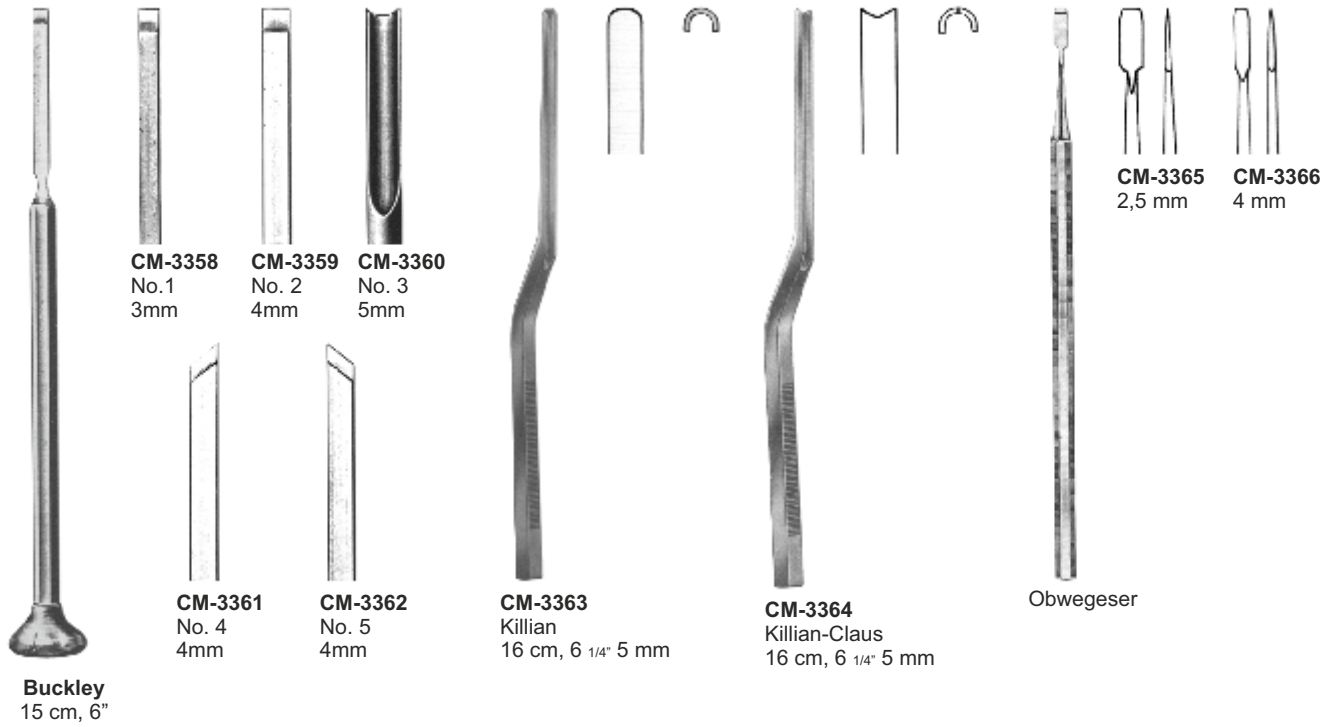



CARE MEDICAL[®]
S U P P L I E S

Your health _ Our Priority

Section

09

Page 160-170

Implants
Instruments

inspiring
confidence in
health
care

www.caremedical.com.pk



Molt
CM-3371 10 cm
CM-3372 11 cm
CM-3373 14 cm



CM-3374 16 cm
CM-3375 19 cm
 Roser-König



CM-3376
 Denhardt
 13 cm



CM-3377
 Fergusson - Ackland
 14.5 cm



CM-3378
 Heister
 Maunder Wood
 9.5 cm



CM-3379
 Obwegeser 11 cm
 Spreading 47 mm



CM-3380
 Heister
 13 cm



CM-3381 Small
CM-3382 Medium
CM-3383 Large
 Cheek Retractor

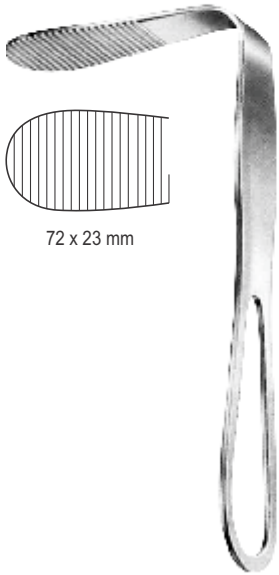

72 x 23 mm

CM-3384
Hartmann
15 cm



CM-3385
Doyen Tongue Spatula
13.5 cm



CM-3386
14.5 cm



CM-3387
18 cm



CM-3388
Bruenings
19 cm

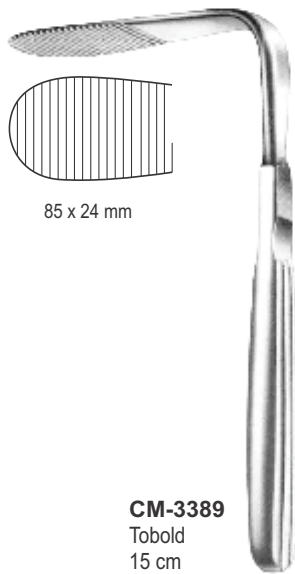

85 x 24 mm

CM-3389
Tobold
15 cm

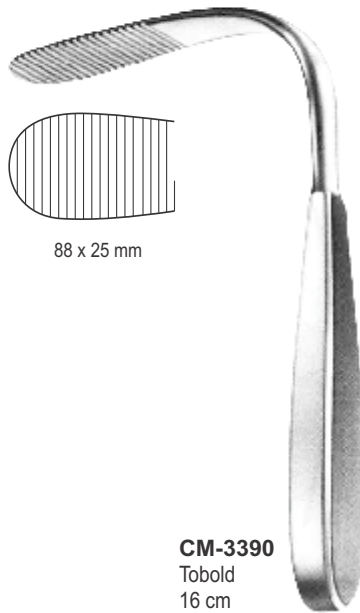

88 x 25 mm

CM-3390
Tobold
16 cm

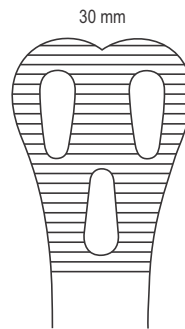

CM-3391
14 cm

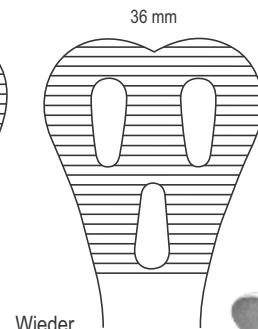

Wieder

CM-3392
15 cm

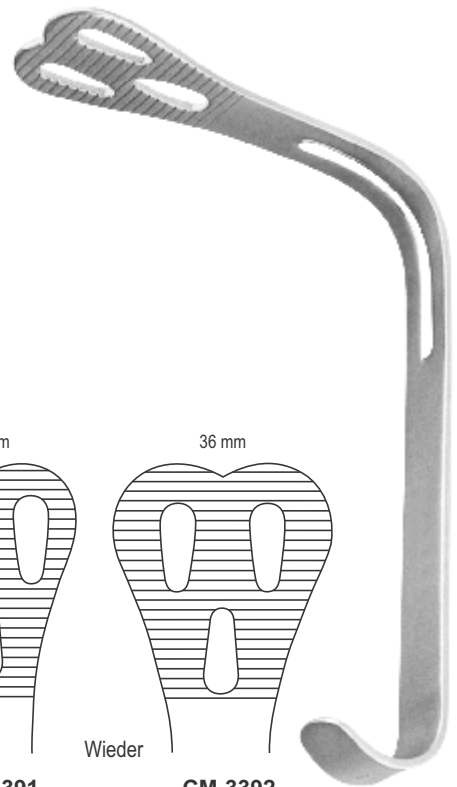

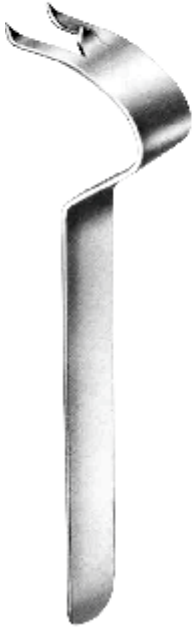

CM-3393
Obwegeser Chin
Retractor
16.5 cm



Obwegeser 16 cm
CM-3394 8 mm
CM-3395 10 mm



CM-3396 43 x 11 mm
CM-3397 57 x 11 mm
CM-3398 83 x 16 mm

35 x 11 mm



CM-3399
Obwegeser
Spina-nasalis retractor
22 cm

72 x 11 mm



CM-3400
Obwegeser
Ramus retractor for
separation of ramus & tissue
22 cm



CM-34001
Simplex
10.5 cm

30x19 mm



33x25 mm

CM-3402
Kilner
15 cm



CM-3403
Minnesota
14 cm



CM-3404
Cawood-Minnesota
15 cm



CM-3405
Austin



CM-3406
Hilger
Fits any simple stem mouth mirror handle



CM-3407
Hilger
with handle

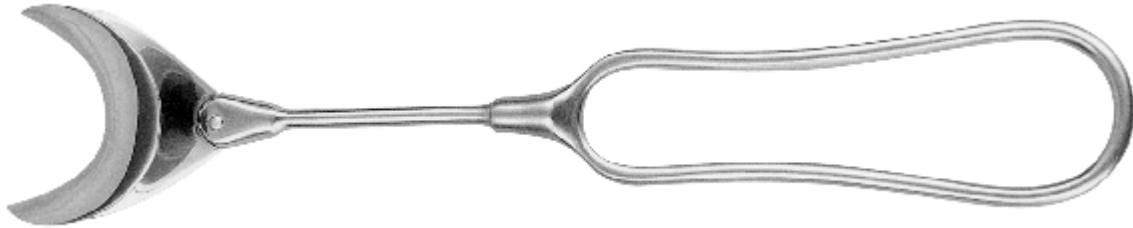

CM-3408
Max
20 cm

Finger protectors



CM-3409 Small
CM-3410 Medium
CM-3411 Large

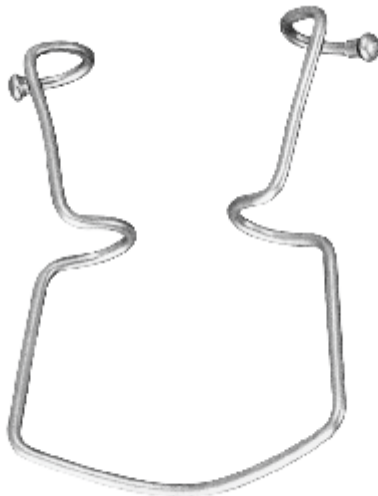

CM-3412
Oringer
11.5 cm

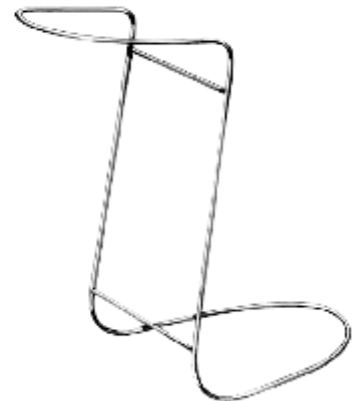

CM-3413
Obwegeser Cheek Retractor
12cm

Langenbeck



CM-3414
Columbia
14.5 cm



CM-3415 12 cm
CM-3416 14 cm
CM-3417 15 cm

Sternberg



Vestibulum
CM-3418



CM-3419
Max

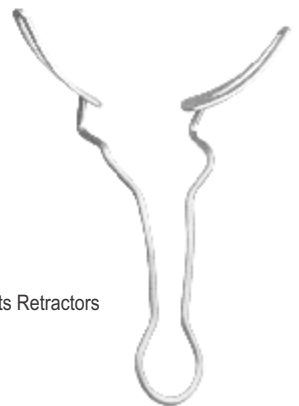

CM-3420
Max

Implants Retractors

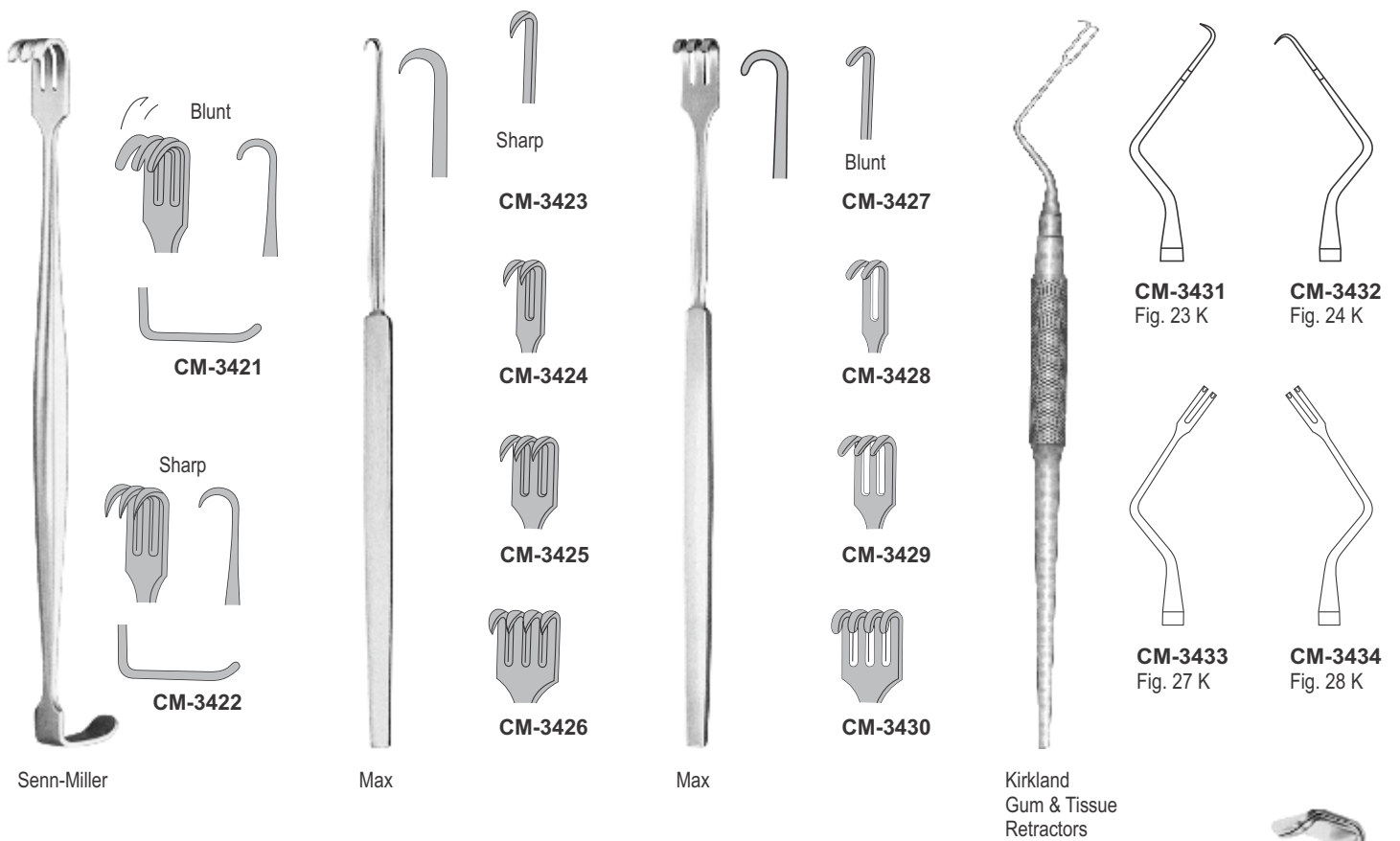

Osteotomes



15.5 cm

# 1	Diam.
0	∅ 1.60
7.5	∅ 1.80
10	∅ 2.00
13.5	∅ 2.40
15.5	∅ 3.60

1
∅ 1.6 mm



CM-3441
15.5 cm

# 2	Diam.
0	∅ 1.90
7.5	∅ 2.20
10	∅ 2.35
13.5	∅ 3.30
15.5	∅ 3.40
23.5	∅ 4.50

2
∅ 1.9 mm



CM-3442
15.5 cm

# 3	Diam.
0	∅ 2.80
7.5	∅ 3.20
10.5	∅ 3.35
13.5	∅ 3.60
21	∅ 4.40

3
∅ 2.8 mm



CM-3443
15.5 cm

# 4	Diam.
0	∅ 3.10
7.5	∅ 3.70
10.5	∅ 3.90
15.5	∅ 4.30

4
∅ 3.10 mm



CM-3444
15.5 cm

# 5	Diam.
0	∅ 3.90
10	∅ 5.00
13	∅ 5.20
20.5	∅ 6.30

5
∅ 3.90 mm



CM-3445
15.5 cm

# 6	Diam.
0	∅ 5.50
10	∅ 6.20
13	∅ 6.30

6
∅ 5.50 mm



CM-3446
15.5 cm

# 1	Diam.
0	∅ 1.50
5	∅ 1.90
8	∅ 2.20
10	∅ 2.40
12	∅ 2.60
14	∅ 2.80

1
∅ 1.5 mm



CM-3447
15.5 cm

# 2	Diam.
0	∅ 2.10
5	∅ 2.60
8	∅ 2.80
10	∅ 3.00
12	∅ 3.20
14	∅ 3.40

2
∅ 2.1 mm



CM-3448
15.5 cm

# 3	Diam.
0	∅ 2.60
5	∅ 3.00
8	∅ 3.30
10	∅ 3.50
12	∅ 3.70
14	∅ 3.90

3
∅ 2.6 mm



CM-3449
15.5 cm

# 4	Diam.
0	∅ 3.00
5	∅ 3.50
8	∅ 3.80
10	∅ 4.00
12	∅ 4.20
14	∅ 4.40

4
∅ 3.0 mm



CM-3450
15.5 cm

# 5	Diam.
0	∅ 3.50
5	∅ 3.90
8	∅ 4.20
10	∅ 4.40
12	∅ 4.60
14	∅ 4.80

5
∅ 3.5 mm



CM-3451
15.5 cm

∅ 2.8 mm



CM-3452
15.5 cm

Spelling Straight
Bone Pusher

∅ 3.5 mm



CM-3453
15.5 cm

∅ 4.2 mm



CM-3454
15.5 cm

Osteotomes



15 cm

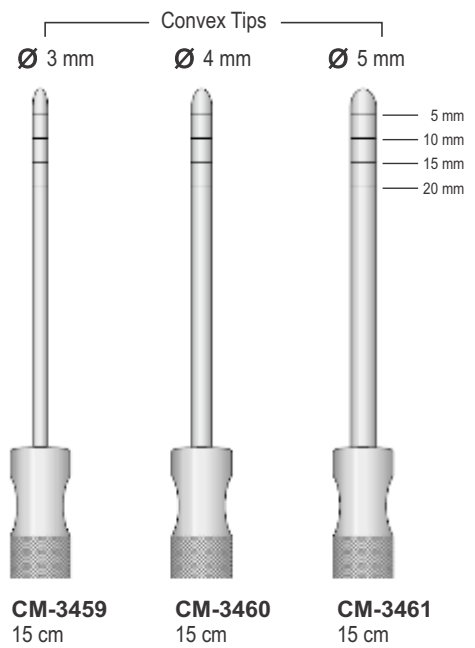
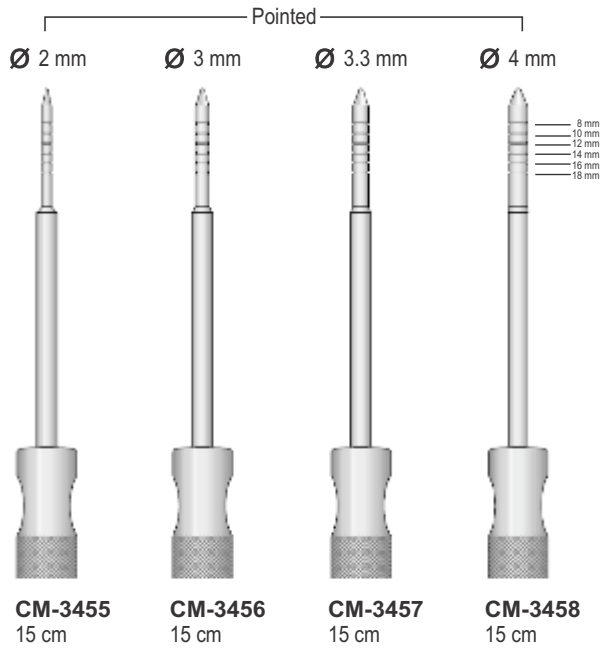

Convex Tips



16.5 cm
Str

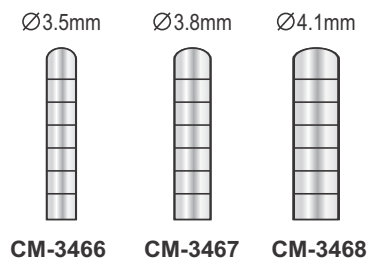
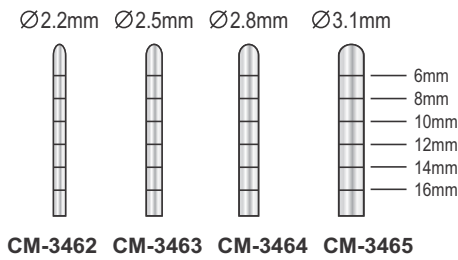

16.5 cm
Cvd

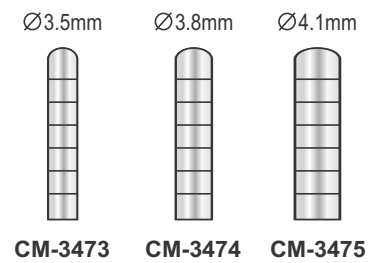
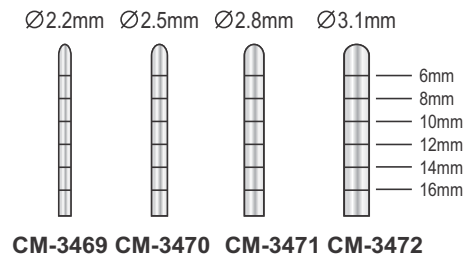

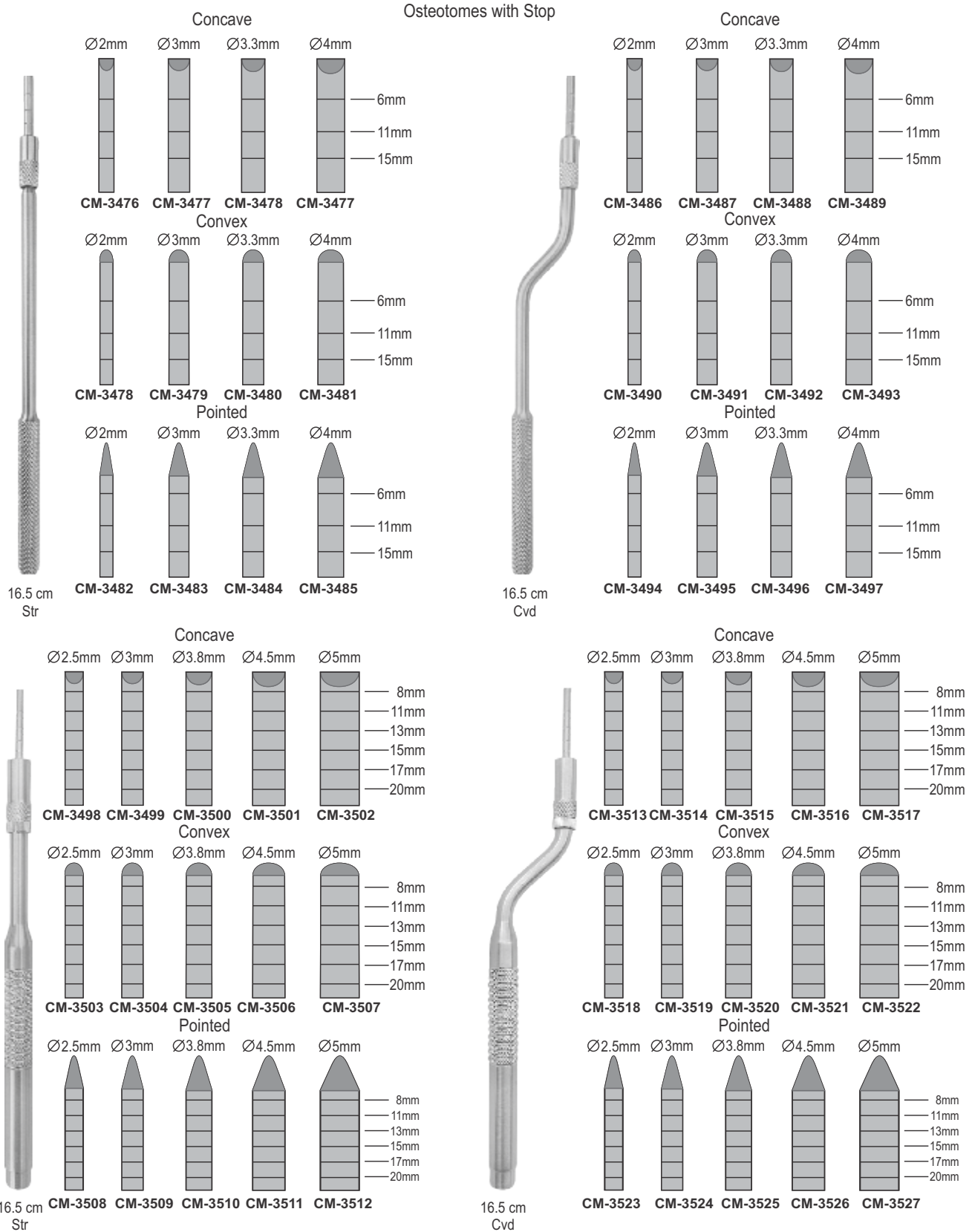



CM-3528 Distal, 2.5 mm Micro Edge



CM-3529 Mesial, 2.5 mm Micro Edge

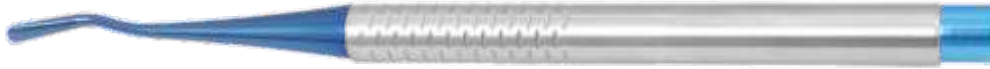

CM-3530 Distal, 4 mm Micro Edge



CM-3531 Mesial 4 mm Micro Edge



CM-3532 2.5 mm Micro Edge, Straight



CM-3533 2.5 mm Micro Edge, Curved



CM-3534 3.4 mm Straight

CM-3535 Set Of 7 Pieces



CM-3536 Distal, 2.5 mm Micro Edge



CM-3537 Mesial, 2.5 mm Micro Edge



CM-3538 Distal, 4 mm Micro Edge



CM-3539 Mesial 4 mm Micro Edge



CM-3540 2.5 mm Micro Edge, Straight

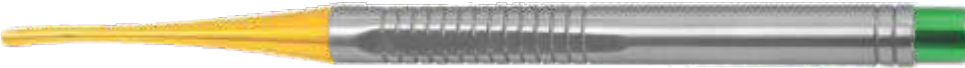

CM-3541 2.5 mm Micro Edge, Curved



CM-3542 3.4 mm Straight

CM-3543 Set Of 7 Pieces



Instruments Tray

Trephine Drills

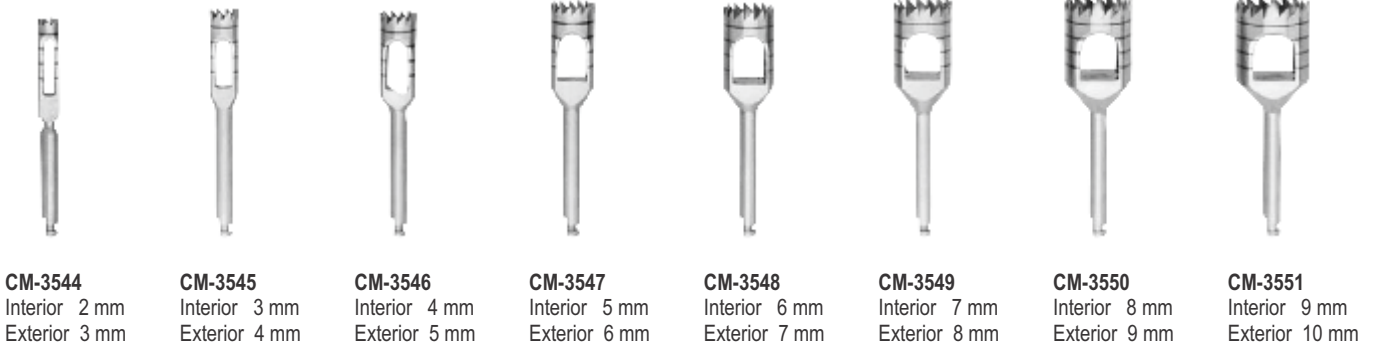

CM-3552
Trephine Drills Stand
Complete with drills



CM-3553
Trephine Drills Stand
Complete with drills

Tissue Punches

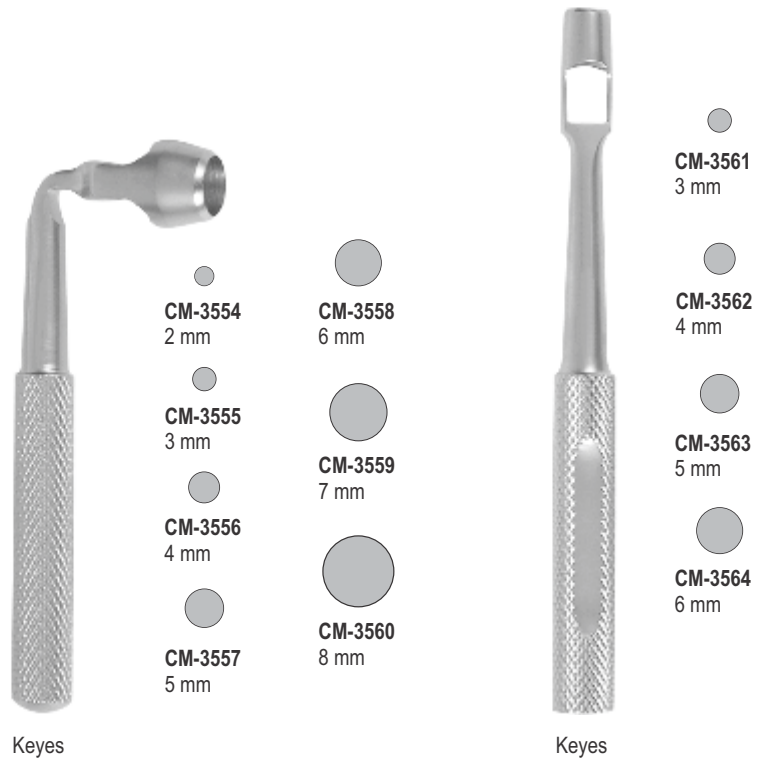



CM-3565
Bone Collector Chisel Straight



CM-3566
Blade for Straight bone collector chisel



CM-3567
Bone Collector Chisel Curved



CM-3568
Blade for Curved bone collector chisel



CM-3569
Ratchet Screw driver handle
Hexagonal head

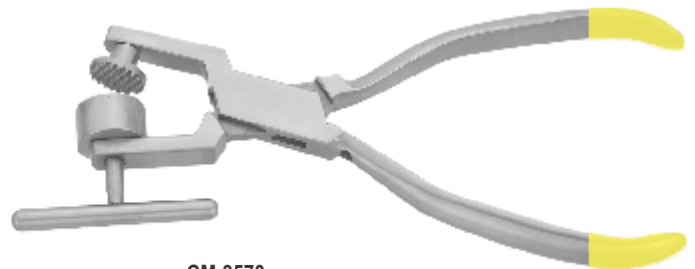

CM-3570
Bone Morselizer with Titanium Grinding



CM-3571
Bone Mixing Basin
Dia 35 mm

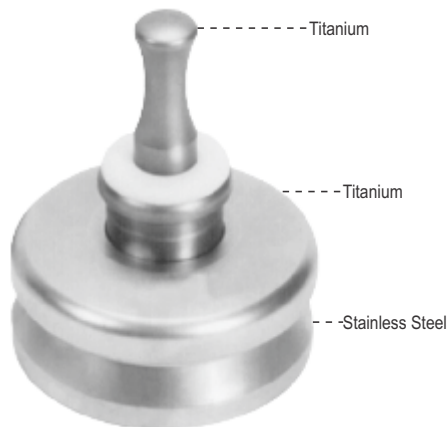

CM-3572
Manual Easy Bone Mill



CM-3573
Bone Craker Titanium



CARE MEDICAL[®]
SUPPLIES

Your health _ Our Priority

Section

10

Page 171-174

Dental
Syringes

inspiring
confidence in
health
care

www.caremedical.com.pk

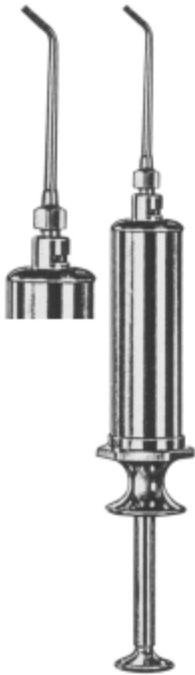

2300
Water Syringe complete with
1 cannula (Lure-Lock)



2301
Water Syringe complete with
1 cannula (Lure-Lock)



2302
Metal water syringe, self-filling,
with 1 cannula (Lure-Lock)



2303
Sparrel Barrel with
plunger suitable for
syringes



2304
Cannula, only, with
Luer-Lock connector
suitable for syringes

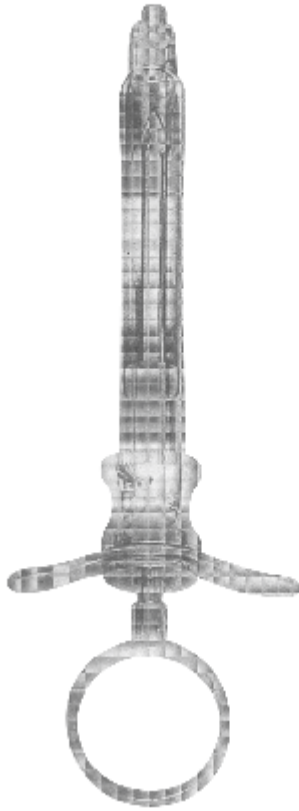

2305
Aspirating Syringe

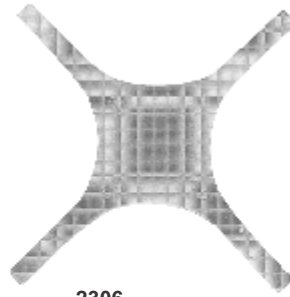

2306
Position Gauge

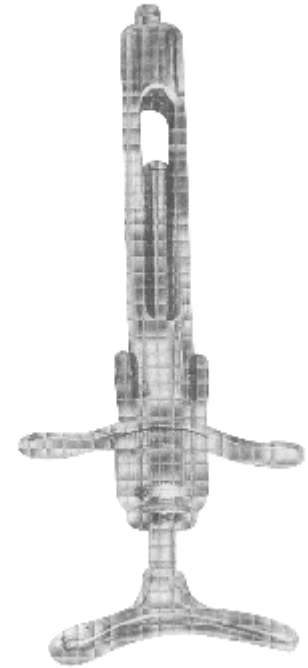

2307
Breech Loading Syringe

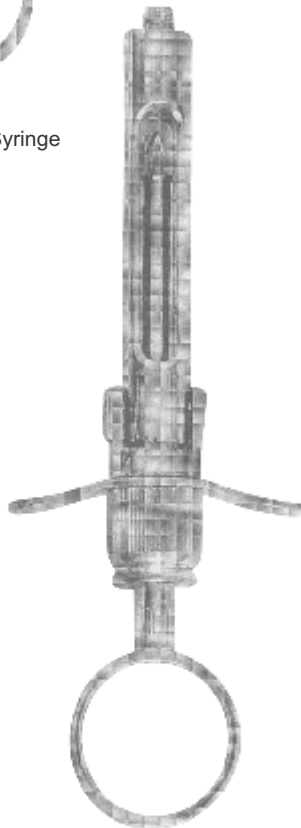

2308
Aspirating & Breech Syringe



2309
Band Adaptor



2310
Endo Finger Ruler
With Adjustable Slide

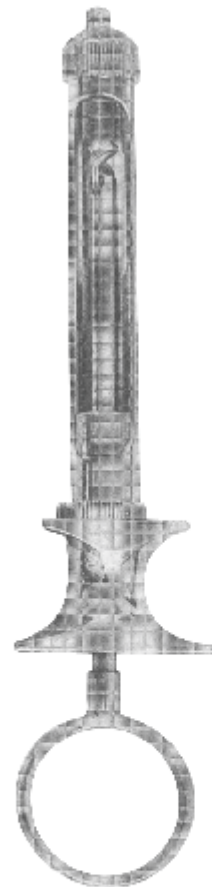

2311
Aspirating Syringe



2312



2313



2314

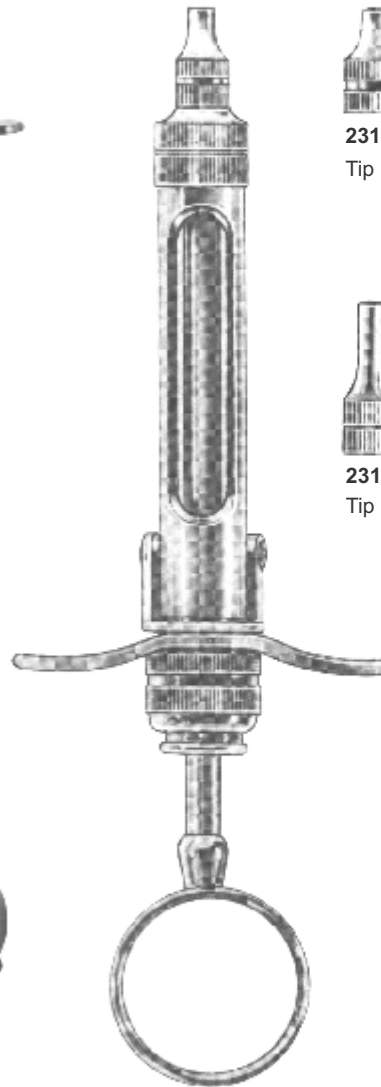

2315 1,8 ml
2316 2,2 ml

Cartridge Syringe complete
With 2 tips and without needles



2317
Tip Only, short



2318
Tip Only, long



2319



2320



2321

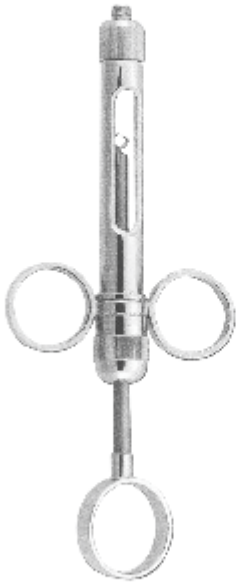

2322
Cork screw tip

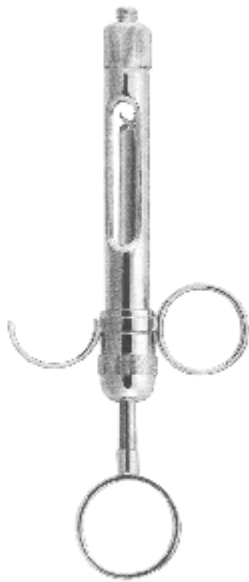

2323
Cork screw tip



2324
Folding type, cork screw tip



2325
Folding type, cork screw tip



2326



2327
Cork screw tip



2328
Spare cap with metric thread



2329
With Whitworth thread

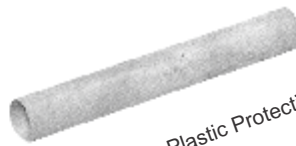

2330
Autoclavable Plastic Protection sleeve



2331
Brass syringe with stainless steel moving parts

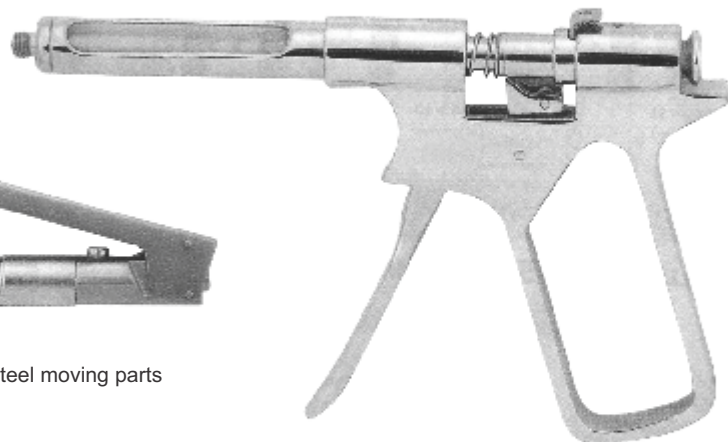

2332
Brass syringe with stainless steel moving parts



CARE MEDICAL[®]
SUPPLIES

Your health _ Our Priority

Section

11

Page 175-190

Hollow
Ware



inspiring
confidence in
health
care

www.caremedical.com.pk



05786
Round Sterilizer Drum

CESTELLI PER STERILIZZARE

Realizzato in acciaio Inox 18/10. Coperchio e fondo stampati, fasce scorrevoli.

ROUND STERILISER DRUM

Manufactured from 18/10 stainless steel. Domed top and bottom with sliding removable band and drop down clasps. Hinged lid.

TAMBOURS POUR LA STERILISATION

Acier inoxydable 18/10, couvercle à charnières et fermetures latérales.

BOMBONA A CHARNELA

De acero inoxidable 18/10. Parte superior con asa y parte inferior con lamina extraíble.

STERILIZACNÍ BUBNY

Vyrobeny z nerezové oceli 18/10. Klenuté víko a dno, posuvná odnímatelná prezka překrývající otvory. Odklápečí víko



05830
Round Sterilizer Drum "Filter"

CESTELLI PER STERILIZZARE CON FILTRO

Realizzato in acciaio Inox 18/10. Coperchio e fondo stampati, fasce scorrevoli e filtri.

ROUND STERILIZER DRUMS "FILTER"

Manufactured from 18/10 stainless steel. Perforated hinged lid and bottom with interchangeable filters. Designed for vertical steam flow.

TAMBOURS POUR LA STERILISATION AVEC FILTRE

Acier inoxydable 18/10, avec filtres.

BOMBONA CON "FILTRO"

De acero inoxidable 18/10. Tapa perforada con asa y parte inferior con filtros intercambiables. Proyectada para flujo de vapor vertical.

STERILIZACNÍ BUBNY S FILTREM

Vyrobeny z nerezové oceli 18/10. Perforované odklápečí víko a dno s vymenitelnými filtry. Navrženo pro vertikální prtok páry.

MODEL DIMENSIONI / SIZE / DIMENSIONS /MEDIDAS /ROZMERY

05786	mm. Ø 125 x 80 H	05801	mm. Ø 240 x 145 H	05816	mm. Ø 340 x 165 H
05787	mm. Ø 125 x 100 H	05802	mm. Ø 240 x 165 H	05817	mm. Ø 340 x 190 H
05788	mm. Ø 125 x 125 H	05803	mm. Ø 240 x 190 H	05818	mm. Ø 340 x 240 H
05789	mm. Ø 150 x 80 H	05804	mm. Ø 240 x 240 H	05819	mm. Ø 340 x 290 H
05790	mm. Ø 150 x 100 H	05805	mm. Ø 240 x 290 H	05820	mm. Ø 340 x 340 H
05791	mm. Ø 150 x 130 H	05806	mm. Ø 240 x 340 H	05821	mm. Ø 340 x 390 H
05792	mm. Ø 150 x 150 H	05807	mm. Ø 240 x 390 H	05822	mm. Ø 390 x 140 H
05793	mm. Ø 150 x 190 H	05808	mm. Ø 290 x 145 H	05823	mm. Ø 390 x 165 H
05794	mm. Ø 190 x 125 H	05809	mm. Ø 290 x 165 H	05824	mm. Ø 390 x 190 H
05795	mm. Ø 190 x 145 H	05810	mm. Ø 290 x 190 H	05825	mm. Ø 390 x 240 H
05796	mm. Ø 190 x 165 H	05811	mm. Ø 290 x 240 H	05826	mm. Ø 390 x 290 H
05797	mm. Ø 190 x 190 H	05812	mm. Ø 290 x 290 H	05827	mm. Ø 390 x 340 H
05798	mm. Ø 190 x 240 H	05813	mm. Ø 290 x 340 H	05828	mm. Ø 390 x 390 H
05799	mm. Ø 190 x 290 H	05814	mm. Ø 290 x 390 H	05829	mm. Ø 390 x 490 H
05800	mm. Ø 240 x 120 H	05815	mm. Ø 340 x 145 H		

MODEL DIMENSIONI / SIZE / DIMENSIONS /MEDIDAS /ROZMERY

05830	mm. Ø 125 x 80 H	05845	mm. Ø 240 x 290 H	05860	mm. Ø 390 x 140 H
05831	mm. Ø 125 x 100 H	05846	mm. Ø 240 x 340 H	05861	mm. Ø 390 x 165 H
05832	mm. Ø 125 x 125 H	05847	mm. Ø 240 x 390 H	05862	mm. Ø 390 x 190 H
05833	mm. Ø 150 x 100 H	05848	mm. Ø 290 x 145 H	05863	mm. Ø 390 x 240 H
05834	mm. Ø 150 x 130 H	05849	mm. Ø 290 x 165 H	05864	mm. Ø 390 x 290 H
05835	mm. Ø 150 x 150 H	05850	mm. Ø 290 x 190 H	05865	mm. Ø 390 x 340 H
05836	mm. Ø 150 x 190 H	05851	mm. Ø 290 x 240 H	05866	mm. Ø 390 x 490 H
05837	mm. Ø 190 x 145 H	05852	mm. Ø 290 x 290 H		
05838	mm. Ø 190 x 165 H	05853	mm. Ø 290 x 340 H		
05839	mm. Ø 190 x 190 H	05854	mm. Ø 290 x 390 H		
05840	mm. Ø 190 x 240 H	05855	mm. Ø 340 x 145 H		
05841	mm. Ø 240 x 145 H	05856	mm. Ø 340 x 165 H		
05842	mm. Ø 240 x 165 H	05857	mm. Ø 340 x 190 H		
05843	mm. Ø 240 x 190 H	05858	mm. Ø 340 x 240 H		
05844	mm. Ø 240 x 240 H	05859	mm. Ø 340 x 290 H		



05867
Instrument Boxes



05875
Instrument Boilers



05883
Wire Mesh Basket

BOLLITORE PER STRUMENTI

In acciaio Inox 18/10 . Base, coperchio e vassoio interno perforato stampati senza saldature.

INSTRUMENT BOILERS

Manufactured from 18/10 stainless steel. Body, lid and perforated internal tray pressed without welding. Hooks to lift the internal tray.

BOUILLEURS A INSTRUMENTS

Acier inoxydable 18/10,, conteneur, couvercle et plateau perforé pressés et sans soudures. Crochets pour fermer le conteneur.

HERVIDOR PARA INSTRUMENTAL

De acero inoxidable 18/10. Cuerpo, tapa y bandeja interior perforados. Estampada sin soldaduras. Tapa con asa para levantar la bandeja interior.

VYVAROVACE NÁSTROJU

Vyrobeny z nerezové oceli 18/10. Vylisováno bez svaru. Úchytky na vyzvednutí vnitřního roštu.

MODEL DIMENSIONI / SIZE / DIMENSIONS /MEDIDAS /ROZMERY

05875	mm. 180 x 80 x 40 H	05879	mm. 300 x 150 x 60 H
05876	mm. 200 x 100 x 60 H	05880	mm. 320 x 150 x 60 H
05877	mm. 220 x 120 x 60 H	05881	mm. 400 x 160 x 75 H
05878	mm. 250 x 120 x 60 H	05882	mm. 500 x 200 x 120 H

COTENITORI IN FILO

Realizzati in acciaio Inox 18/10

WIRE MESH BASKETS

Manufactured from 18/10 stainless steel

PANIERS

Acier inoxydable 18/10

CESTILLOS DE ALAMBRE

De acero inoxidable 18/10

DRÁTENÁ SÍTA NA NÁSTROJE

Vyrobená z nerezové oceli 18/10.

MODEL L I H MODEL L I H

05883	mm. 210	145	50	05888	mm. 480	240	50
05884	mm. 240	240	50	05889	mm. 540	240	50
05885	mm. 240	240	70	05890	mm. 540	240	70
05886	mm. 240	240	90	05891	mm. 540	240	90
05887	mm. 240	320	50				



05892
Instrument Tray with cover

VASSOIO PORTASTRUMENTICON COPERCHIO

Realizzato in acciaio Inox 18/10.

Stampato senza saldature.

INSTRUMENT TRAYS WITH COVER

Manufactured from 18/10 stainless steel. Pressed without welding.

PLATEAUX A INSTRUMENTS AVEC COUVERCLE

Acier inoxydable 18/10, conteneur pressés et sans soudures.

BANDEJAS PARA INSTRUMENTAL CON TAPA

De acero inoxidable 18/10. Sin soldaduras.

TÁC NA NÁSTROJE S VÍCKEM

Vyroběn z nerezové oceli 18/10 lisováním bez svaru.

Rovné dno.

MODEL DIMENSIONI / SIZE / DIMENSIONS /MEDIDAS /ROZMERY

05892	mm. 200 x 150 x 25	05896	mm. 220 x 170 x 50
05893	mm. 260 x 180 x 30	05897	mm. 280 x 200 x 50
05894	mm. 300 x 220 x 30	05898	mm. 320 x 240 x 50
05895	mm. 350 x 250 x 40	05899	mm. 370 x 270 x 50
		05900	mm. 460 x 360 x 55



05901
Instrument Tray without cover

VASSOIO PORTASTRUMENTI

Realizzato in acciaio Inox 18/10. Stampato senza saldature.

INSTRUMENT TRAYS

Manufactured from 18/10 stainless steel. Pressed without welding.

PLATEAUX A INSTRUMENTS

Acier inoxydable 18/10, conteneur pressés et sans soudures.

BANDEJAS PARA INSTRUMENTAL

De acero inoxidable 18/10.

Sin soldaduras.

TÁC NA NÁSTROJE

Vyroběn z nerezové oceli 18/10 lisováním bez svaru. Rovné dno.

MODEL DIMENSIONI / SIZE / DIMENSIONS /MEDIDAS /ROZMERY

05901	mm. 200 x 150 x 25	05905	mm. 220 x 170 x 50
05902	mm. 260 x 180 x 30	05906	mm. 280 x 200 x 50
05903	mm. 300 x 220 x 30	05907	mm. 320 x 240 x 50
05904	mm. 350 x 250 x 40	05908	mm. 370 x 270 x 50
		05909	mm. 460 x 360 x 55



INSTRUMENTS WITH COVER

MODEL	DIMENSIONI / SIZE / DIMENSIONS / MEDIDAS / ROZMERY
05910	mm. 210 x 110 x 50 W/internal tray
05911	mm. 240 x 160 x 50 W/internal tray
05912	mm. 300 x 180 x 50 W/internal tray
05913	mm. 360 x 210 x 50 W/internal tray
05914	mm. 400 x 230 x 55 W/internal tray

**05910
Instruments Trays**

INSTRUMENTS WITHOUT COVER

MODEL	DIMENSIONI / SIZE / DIMENSIONS / MEDIDAS / ROZMERY
05915	mm. 210 x 110 x 50
05916	mm. 240 x 160 x 50
05917	mm. 300 x 180 x 50
05918	mm. 360 x 210 x 50
05919	mm. 400 x 230 x 55

VASSOIO PORTASTRUMENTICON COPERCHIO

Realizzata in acciaio Inox 18/10. Stampata senza saldature. Con due maniglie laterali.

INSTRUMENT TRAYS WITH COVER

Manufactured from 18/10 stainless steel. Pressed without welding. Two side handles

PLATEAUX A INSTRUMENTS AVEC COUVERCLE

Acier inoxydable 18/10, pressé et sans soudures. Deux poignées de manipulation.

BANDEJAS PARA INSTRUMENTAL CON TAPA

De acero inoxidable 18/10. Estampada sin soldaduras. Dos asas laterales.

TÁC NA NÁSTROJE S VÍCKEM

Vyroběn z nerezové oceli 18/10. Lisováno bez svarů. Dvě postranní úchytky.

BACINELLA PORTA FERRI

Realizzata in acciaio Inox 18/10. Stampata senza saldature. Con due maniglie laterali.

INSTRUMENT TRAYS

Manufactured from 18/10 stainless steel. Pressed without welding. Two side handles

PLATEAUX A INSTRUMENTS

Acier inoxydable 18/10, pressé et sans soudures. Deux poignées de manipulation.

CAJAS PARA INSTRUMENTAL

De acero inoxidable 18/10. Estampada sin soldaduras. Dos asas laterales.

VYVAŘOVAČ NÁSTROJŮ

Vyroběn z nerezové oceli 18/10. Lisováno bez svarů. Dvě postranní úchytky.



**05920
Gallipot**

GALLIPOT

Realizzata in acciaio Inox 18/10. Stampata senza saldature. Base piatta.

GALLIPOT

Manufactured from 18/10 stainless steel. Pressed without welding. Flat bottom.

GALLIPOT

Acier inoxydable 18/10, pressé et sans soudures, fond plat.

GALLIPOT

De acero inoxidable 18/10. Sin soldaduras. Base plana.

GALLIPOT

Vyrobena z nerezové oceli 18/10 lisováním bez svarů. Rovné dno.

MODEL	DIMENSIONI / SIZE / DIMENSIONS / MEDIDAS / ROZMERY
05920	Ø 40 mm ml.30
05921	Ø 60 mm ml.50
05922	Ø 80 mm ml.150
05923	Ø 100 mm ml.250
05924	Ø 120 mm ml.450
05925	Ø 150 mm ml.750
05926	Ø 180 mm ml.1500
05927	Ø 200 mm ml.2100
05928	Ø 250 mm ml.3500



05929
Round Bowls with & without Cover

CAPSULA

Realizzata in acciaio Inox 18/10. Stampata senza saldature. Base piatta.

ROUND BOWLS

Manufactured from 18/10 stainless steel. Pressed without welding. Flat bottom.

CUVETTES

Acier inoxydable 18/10, pressé et sans soudures, fond plat.

CUBETAS REDONDAS

De acero inoxidable 18/10. Sin soldaduras.

Base plana.

KRUHOVÁ MISKA

Vyrobena z nerezové oceli 18/10 lisováním bez svaru. Rovné dno.

MODEL DIMENSIONI / SIZE / DIMENSIONS /MEDIDAS /ROZMERY

05929	Ø 40 mm ml.30	05934	Ø 150 mm ml.750
05930	Ø 60 mm ml.50	05935	Ø 180 mm ml.1500
05931	Ø 80 mm ml.150	05936	Ø 200 mm ml.2100
05932	Ø 100 mm ml.250	05937	Ø 250 mm ml.3500
05933	Ø 120 mm ml.450		



05938
Sputum Cup

SPUTACCHIERA

Realizzata in acciaio Inox 18/10 stampata senza saldature. Con impugnatura e coperchio.

SPUTUM CUP

Manufactured from 18/10 stainless steel. Pressed without welding, complete with handle and lid.

CRACHOIR

Acier inoxydable 18/10. Avec couvercle, poignée, sans soudures.

ESCUPIDERA

De acero inoxidable 18/10. Sin soldaduras.

Con asa y tapa.

NÁDOBA NA SPUTUM

Vyrobena z nerezové oceli 18/10. Lisována bez svaru, dodávána s držákem a víčkem.



05939
Kidney bowls with Cover

BACINELLA RENIFORME CON COPERCHIO

Realizzata in acciaio Inox 18/10. Stampata senza saldature

KIDNEY BOWLS WITH COVER

Manufactured from 18/10 stainless steel. Pressed without welding.

HARICOTS AVEC COUVERCLE

Acier inoxydable 18/10, sans soudures.

RIÑONERAS CON TAPA

De acero inoxidable 18/10. Sin soldadura.

EMITNÍ MISKA S VÍČKEM

Vyrobena z nerezové oceli 18/10 lisováním bez svaru.

MODEL DIMENSIONI / SIZE / DIMENSIONS /MEDIDAS /ROZMERY

05939	mm. 200 x 150 x 25	05941	mm. 300 x 220 x 30
05940	mm. 260 x 180 x 30	05942	mm. 350 x 250 x 40



BACINELLA RENIFORME

Realizzata in acciaio Inox 18/10. Stampata senza saldature

KIDNEY BOWLS

Manufactured from 18/10 stainless steel. Pressed without welding.

HARICOTS

Acier inoxydable 18/10, sans soudures.

RIÑONERAS

De acero inoxidable 18/10. Sin soldadura.

EMITNÍ MISKA

Vyrobena z nerezové oceli 18/10 lisováním bez svaru.

MODEL DIMENSIONI / SIZE / DIMENSIONS /MEDIDAS /ROZMERY

05943	mm. 200 x 150 x 25	05945	mm. 300 x 220 x 30
05944	mm. 260 x 180 x 30	05946	mm. 350 x 250 x 40



05947
Irrigator

IRRIGATORE
Realizzato in acciaio Inox 18/10 stampato senza saldature. Con manico e anello di sostegno.

IRRIGATOR
Manufactured from 18/10 stainless steel, without welding. with handle and holder

IRRIGATEUR
Acier inoxydable 18/10, sans soudure. Avec poignée de manipulation et crochet.

IRRIGADOR
De acero inoxidable 18/10, sin soldaduras. Con asa y gancho.

IRIGÁTOR
Vyroben z nerezové oceli 18/10. S rukojetí a držákem

MODEL DIMENSIONI / SIZE / DIMENSIONS /MEDIDAS /ROZMERY

05947	1000 ml
05948	10 1500 ml
05949	20 2000 ml



05960
Forceps Jar

PORTA STRUMENTI
Realizzato in acciaio Inox 18/10.

FORCEP JARS
Manufactured from 18/10 stainless steel.

BOITE A PINCES
Acier inoxydable 18/10.

CUBETA POR PINZAS
Construida en acero inoxidable 18/10.

TOULEC NA NÁSTROJE
Vyroben z nerezové oceli 18/10.

MODEL DIMENSIONI / SIZE / DIMENSIONS /MEDIDAS /ROZMERY

05960	Ø 30 x 90 mm
05961	Ø 50 x 130 mm
05962	Ø 50 x 180 mm



05950
Measuring Jar

CARAFFA GRADUATA
Realizzata in acciaio Inox 18/10 stampata senza saldature. Con impugnatura.

GRADUATED MEASURING JAR
Manufactured from 18/10 stainless steel, without welding. With handle.

VASE À MESURER GRADUÉ
Acier inoxydable 18/10, sans soudure. Avec poignée.

VASO GRADUADO PARA MEDIR
De acero inoxidable 18/10, sin soldaduras. Con asa lateral.

NEREZOVÁ ODMERKA SE STUPNICÍ
Vyrobena z nerezové oceli 18/10 lisováním bez svaru. S rukojetí a držákem.

MODEL DIMENSIONI / SIZE / DIMENSIONS /MEDIDAS /ROZMERY

05950	500 ml
05951	2000 ml

05952
Dressing Jar

VASO PORTA MEDICAZIONI
Realizzato in acciaio Inox 18/10. Con coperchio.

DRESSING JAR
Manufactured from 18/10 stainless steel, with cover.

VASE POUR PANSEMENT
Acier inoxydable 18/10, avec couvercle.

VASO PARA MEDICACION
De acero inoxidable 18/10, con tapa.

DÓŽA NA OBVAZY
Vyrobena z nerezové oceli 18/10, s víkém.

MODEL DIMENSIONI / SIZE / DIMENSIONS /MEDIDAS /ROZMERY

05952	mm. 75 x 75	05956	mm. 180 x 180
05953	mm. 100 x 100	05957	mm. 200 x 200
05954	mm. 125 x 125	05958	mm. 250 x 250
05955	mm. 150 x 150	05959	mm. 300 x 300





PADELLA

Realizzata in acciaio Inox 18/10 stampata senza saldature. Con impugnatura.

BED PAN

Manufactured from 18/10 stainless steel, pressed without welding. With handle.

BASSIN DE LIT

Acier inoxydable 18/10, sans soudures.

Avec poignée.

CHATA

De acero inoxidable 18/10. Sin soldaduras. Con asa.

LOŽNÍ MÍSA

Vyrobená z nerezové oceli 18/10 lisováním bez svarů. S rukojetí.

MODEL DIMENSIONI / SIZE / DIMENSIONS / MEDIDAS / ROZMERY

05963

Adult Adulte Adulto Adulto Pro dospělé

05964

Child Enfant Nino Pediatrico Pro děti



05965

Bed Pan

PADELLA ROTONDA

Realizzata in acciaio Inox 18/10 stampata senza saldature. Con impugnatura.

BED PAN

Manufactured from 18/10 stainless steel, pressed without welding. With handle.

BASSIN DE LIT

Acier inoxydable 18/10, sans soudures.

Avec poignée.

CHATA

De acero inoxidable 18/10. Sin soldaduras.

Con asa.

LOŽNÍ MÍSA

Vyrobená z nerezové oceli 18/10 lisováním bez svarů. S rukojetí.

MODEL DIMENSIONI / SIZE / DIMENSIONS / MEDIDAS / ROZMERY

05965

Senza coperchio Without cover Sans couvercle
Sin tapa Bez víka

05966

Con coperchio With cover Avec couvercle
Con tapa S víkem

05967

Bed Pan "Fracture" Type

PADELLA DA LETTO

Realizzata in acciaio Inox 18/10.

BED PAN "FRACTURE" TYPE

Manufactured from 18/10 stainless steel.

BASSIN DE LIT

Acier inoxydable 18/10.

CHATA

De acero inoxidable 18/10.

LOŽNÍ MÍSA

Vyrobená z nerezové oceli 18/10.



MODEL DIMENSIONI / SIZE / DIMENSIONS / MEDIDAS / ROZMERY

05967

Adult Adulte Adulto Adulto Pro dospělé

05968

Child Enfant Nino Pediatrico Pro děti



05969

Female Urinal

PAPPAGALLO PER DONNA

Realizzato in acciaio Inox 18/10.

Con impugnatura.

FEMALE URINAL

Manufactured from 18/10 stainless steel. With handle.

FEMME URINAL

Acier inoxydable 18/10, avec poignée.

FEMENINO ORINAL

De acero inoxidable 18/10. Con asa.

NÁDOBA NA MOC PRO ŽENY

Vyrobená z nerezové oceli 18/10. S rukojetí.



05970

Male Urinal

PAPPAGALLO PER UOMO

Realizzato in acciaio Inox 18/10.

Con impugnatura.

MALE URINAL

Manufactured from 18/10 stainless steel. With handle.

HOMME URINAL

Acier inoxydable 18/10, avec poignée.

MASCULINO ORINAL

De acero inoxidable 18/10. Con asa.

NÁDOBA NA MOC PRO MUŽE

Vyrobená z nerezové oceli 18/10. S rukojetí.

Stainless steel trays with locking instruments in silicon, resistant to corrosion. Medesy trays are simple to use and improve the protection and the storage of your valuables instruments. Maximize the efficiency and performance of washing and sterilization.



981
mm 288 x 182 x 35
20 instruments

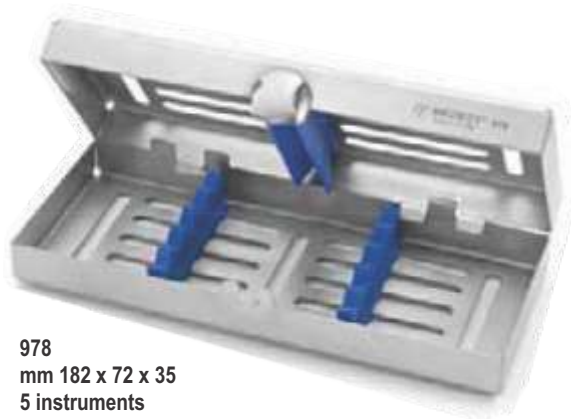

978
mm 182 x 72 x 35
5 instruments



980
mm 182 x 145 x 35
10 instruments



977/10
mm 185 x 150 x 20
10 instruments



977
mm 180 x 85 x 15
5 instruments



981/M
mm 288 x 182 x 35
20 instruments

CARE MEDICAL IN SPOT

Trays "M-Series" has more open areas, specially designed for better cleaning and sterilizing process.



981/M
mm 288 x 182 x 35
20 instruments



Stainless Steel Safety Lock



963
mm 290 x 190 x 60
Aluminium container with 2 filters

963/f
Filters spare parts, one pair



Easy Lock

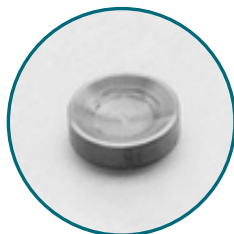

Anti-slippage

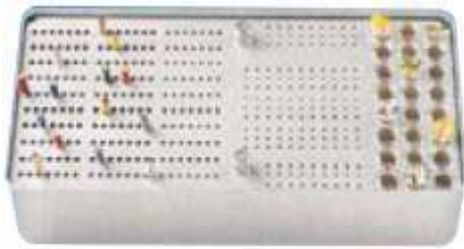

985
mm 204 x 105 x 54



989
mm 125 x 125 x 54



994
mm 104 x 44 x 54



986
mm 204 x 105 x 54



990
mm 125 x 125 x 54



995
mm 104 x 44 x 54



987
mm 204 x 105 x 54



988
mm 204 x 105 x 54



995
mm 104 x 44 x 54



996
mm 104 x 44 x 54



991/d
mm 104 x 44 x 54

991/r
mm 104 x 44 x 54



993
mm 104 x 44 x 54



992
mm 104 x 44 x 54



6150
 ø mm 34 – h mm 48
 Grey or colored top side



6200
 ø mm 94 – h mm 67



6201/V
 ø mm 48 – h mm 58



6201/D
 ø mm 48 – h mm 58



6204/R
 ø mm 48 – h mm 58



6204/G
 ø mm 48 – h mm 58



6160/B
 mm 100 x 40 x 40
 Endometer silver, red, blue



6160/r
 Red



6160/G
 Silver

Aluminium canal instruments holder



972
mm 100 x 50 x 25



971
mm 50 x 50 x 25

Aluminium low mill holders

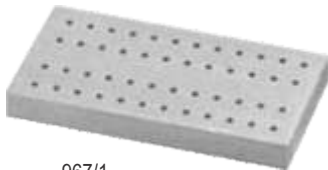

967/1
mm 75 x 40
48 holes FG (small burs)



967/3
mm 75 x 40
48 holes FG/CA (small and big burs)



967/2
mm 75 x 40
48 holes CA (big burs)

Aluminium mill holders



966/1
mm 60 x 40
36 holes FG (small burs), with lid



966/2
mm 60 x 40
36 holes CA (big burs), with lid



966/3
mm 60 x 40
36 holes FG/CA (small and big burs), with lid



966/4
Lid. Not autoclavable



965/1
24 holes FG (small burs), with lid



965/2
24 holes CA (big burs), with lid



965/3
24 holes FG/CA (small and big burs), with lid



965/4
Lid. Not autoclavable

969
Box with 2 bur holders



932
mm 85 x 35



934
mm 105 x 40

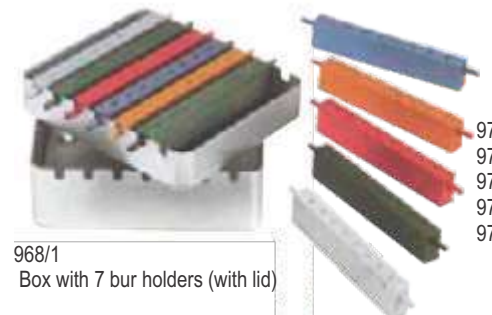

968/1
Box with 7 bur holders (with lid)

970/1B
970/1a
970/1r
970/1V
970/1G



1150
ø mm 30 inox



1152
ø mm 80 inox



1149
ø mm 25 inox



1151
ø mm 60 inox



1148
ø max mm 45



6300
mm 150 x 80 x 15
Mixing glass

6161
mm 85 x 85 x 360
Drinking cup dispenser



215/1 (ø mm 100)
215/2 (ø mm 120)
215/3 (ø mm 140)
215/4 (ø mm 160)
Mixing bowls for plaster
and alginates



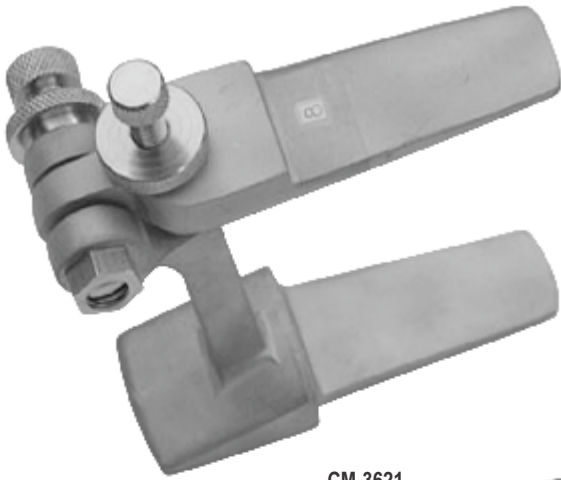

CM-3621



CM-3622



CM-3624



CM-3623

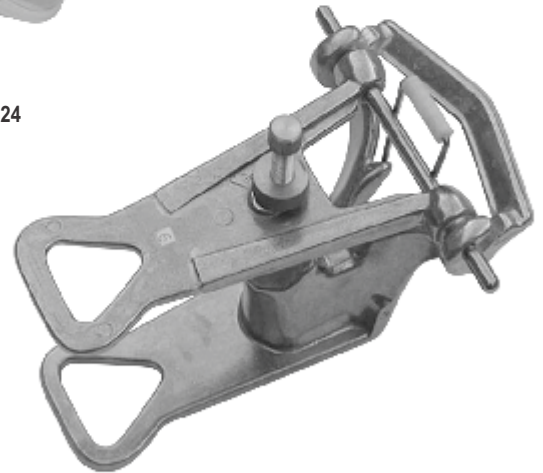

CM-3626



CM-3625



CM-3627



CM-3628



CM-3629



CM-3630



 Noal More, Roras Road,
Sialkot 51310 - Pakistan.

 0092 323 4303862

 0092 323 4303862

 info@caremedical.com.pk

 www.caremedical.com.pk



cGMP



ISO:9001:2015
ISO:13485:2016