



CARE MEDICAL[®]
SUPPLIES

SURGICAL
INSTRUMENTS
CATALOGUE



"Your Health Our Priority"

www.caremedical.com.pk

Company Profile

We have the honor to present our website catalogue of Surgical Instruments, Dental Instruments, Ophthalmic Instruments and Holloware for your perusal reference.

We take this opportunity to introduce our self as CARE MEDICAL SUPPLIES is leading Manufacturers & Exporters of all type of Surgical, Dental, Ophthalmic Instruments & Holloware. We are running our business very successfully from last one decade and growing day by day with our excellent quality products and customer satisfaction approach. The company manufactures over 6000 products and is dedicated to provide supreme quality and service. All our administration and sales staff are highly trained, which enables us to continuously monitor and achieve complete customer satisfaction.

QUALITY ACHIEVEMENTS:

It is added that our company is also holder of certificates of international quality standards such as ISO-9001:2000, cGMP & CE Mark, which reflects the quality service of our instruments. We are interested not only to sale our products but also build a good and long-term relationship with our customers.

QUALITY POLICY:

CARE MEDICAL SUPPLIES is guaranteed for quality instruments. We have better workmanship and correct design. Products are tested at each stage of manufacturing to last stage of packing / dispatch to ensure proper working of the instruments. We at CARE MEDICAL SUPPLIES has an endeavor to increase market share and are committed to continually improve the effectiveness of quality management systems of our instruments by meeting the requirements of our customers. Throughout manufacturing we maintain complete traceability for all materials used. We therefore feel that our quality system is very effective and it helps us to maintain our tradition of only Producing Quality Products.

OUR MISSION:

Our mission is to provide premium quality, value and innovation to our customers in order for them to achieve maximum return on their investment. we try to achieve by utilizing effective corporate practices, efcient teamwork and synergetic organization culture. each individual in our team shall work towards total quality culture aiming for customer satisfaction.

Care Medical enjoy a very satisfactory position for dental instruments when we take a broader view of the products we offer our customers. We are focused on delivering the highest quality product and service in the dental industry in order to help dental professionals perform at their best.



Quality & Standards:

We have been honored with ISO 9001:2002, ISO 13485:2003 Certificates & Authorized CE Marking. We are FDA and SFDA Certified. We developed and manufactured in compliance with the most Stringent Quality requirements, from the initial selection of corrosion resistant chrome steel and the manufacturing and heat treatment right through to the final finish, inspection and testing.

Guarantee:

We believe in outstanding quality and durability so all the products we offer cover's international Guarantee in connect with appropriate and professional use.



R&D:

The Passion and the Desire to make surgeries as smooth and as easy our department continue to developed products that matters in health sector today. This will of continues struggle comes from our relationship as a human beings. We are committed to bring out the best solutions for our customers.











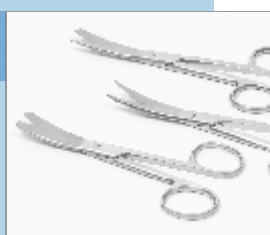
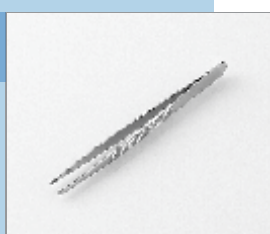

01		<p>Scalpels and Knives</p> <p style="text-align: right;">Page 01 - 12</p>
02		<p>Preparation Instruments And Diagnostic Sets</p> <p style="text-align: right;">Page 13 - 16</p>
03		<p>Tongue Depressors Examination & Measuring Instruments Razor Blade Holders & Breakers</p> <p style="text-align: right;">Page 17 - 21</p>
04		<p>Scissors</p> <p style="text-align: right;">Page 22 - 68</p>
05		<p>Dissecting and Tissue Forceps</p> <p style="text-align: right;">Page 69 - 86</p>
06		<p>Haemostatic Forceps</p> <p style="text-align: right;">Page 87-115</p>
07		<p>Sponge and Dressing Forceps Washing Forceps Organ and Tissue Grasping Forceps Towel Clamps</p> <p style="text-align: right;">Page 116 - 124</p>

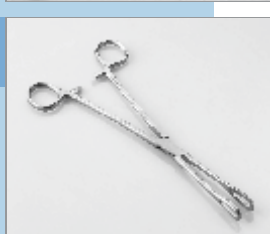
TABLE OF CONTENTS

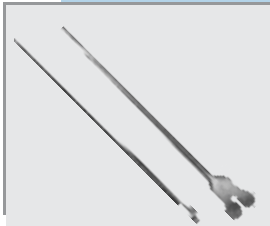
<p>Page 125 - 145</p>	<p>Needle Holders Suture Instruments Ligature Needles Guiding Probes</p>		<p>08</p>
<p>Page 146 - 152</p>	<p>Probes Cotton Applicators Suture Clips Clip Applying Forceps</p>		<p>09</p>
<p>Page 153 - 187</p>	<p>Wound Retractors</p>		<p>10</p>
<p>Page 188 - 212</p>	<p>Self-Retaining Retractors Abdominal Retractors</p>		<p>11</p>
<p>Page 213 - 247</p>	<p>Abdominal Surgery Intestinal and Rectal Instruments</p>		<p>12</p>
<p>Page 248 - 258</p>	<p>Gall Bladder, Liver and Spleen Instruments Genito-Urinary Instruments</p>		<p>13</p>
<p>Page 259</p>	<p>Trocars</p>		<p>14</p>













15		Vaginal Specula	Page 260 - 270
16		Dilators Bioopsy Instruments And Currettes Uterine Probes, Uterine Dressing - Tenaculum Ovum Forceps, Uterine Elevating Forceps	Page 271 - 293
17		Obstetrics Tracheotomy	Page 294 - 302
18		Cardiovascular And Thoracic Surgery Muller Vessel Clips Bulldog Clamps	Page 303 - 365
19		Bone Punches Rongeurs Amputation	Page 366 - 384
20		Elevators Bone Levers Raspatories Bone Files	Page 385 - 403
21		Mallets Tempers, Chisels, Gouges Bone Holding Forceps Rongeurs	Page 404 - 460

TABLE OF CONTENTS

<p>Page 461 - 467</p>	<p>Plaster Instruments</p>		<p>22</p>
<p>Page 468 - 496</p>	<p>NeuroSurgery Laminectomy</p>		<p>23</p>
<p>Page 497 - 533</p>	<p>ENT Surgery</p>		<p>24</p>
<p>Page 534 - 550</p>	<p>Micro Instruments</p>		<p>25</p>
<p>Page 551 - 563</p>	<p>Suction Instruments Intestinal and Rectal Instruments</p>		<p>26</p>
<p>Page 564 - 579</p>	<p>Kidney Trays Bowls Instruments Trays Sterilization Drums and Baskets</p>		<p>27</p>

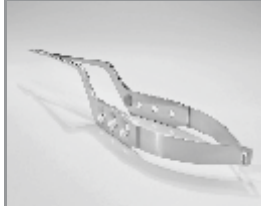
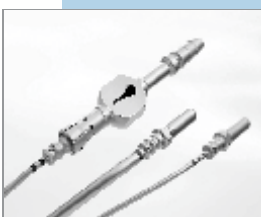

CARE MEDICAL[®]
S U P P L I E S

Your health _ Our Priority

Section

01

Page 01-11

Dissecting Knives
Autopsy, Cartilage, Post Mortem & Brain Knives
Razor Blade Holders & Breakers
Scalpel Handle
Scalpels, Tenotomes
Amputating Knives, Autopsy Knives
Scalpels, Tenotomes & Resection Knives
Dermatomes



CM01-001 - CM01-010
Fig. 1 - 10



CM01-001
Fig. 1



CM01-002
Fig. 2



CM01-003
Fig. 3



CM01-004
Fig. 4



CM01-005
Fig. 5



CM01-006
Fig. 6



CM01-007
Fig. 7



CM01-008
Fig. 8



CM01-009
Fig. 9



CM01-010
Fig. 10

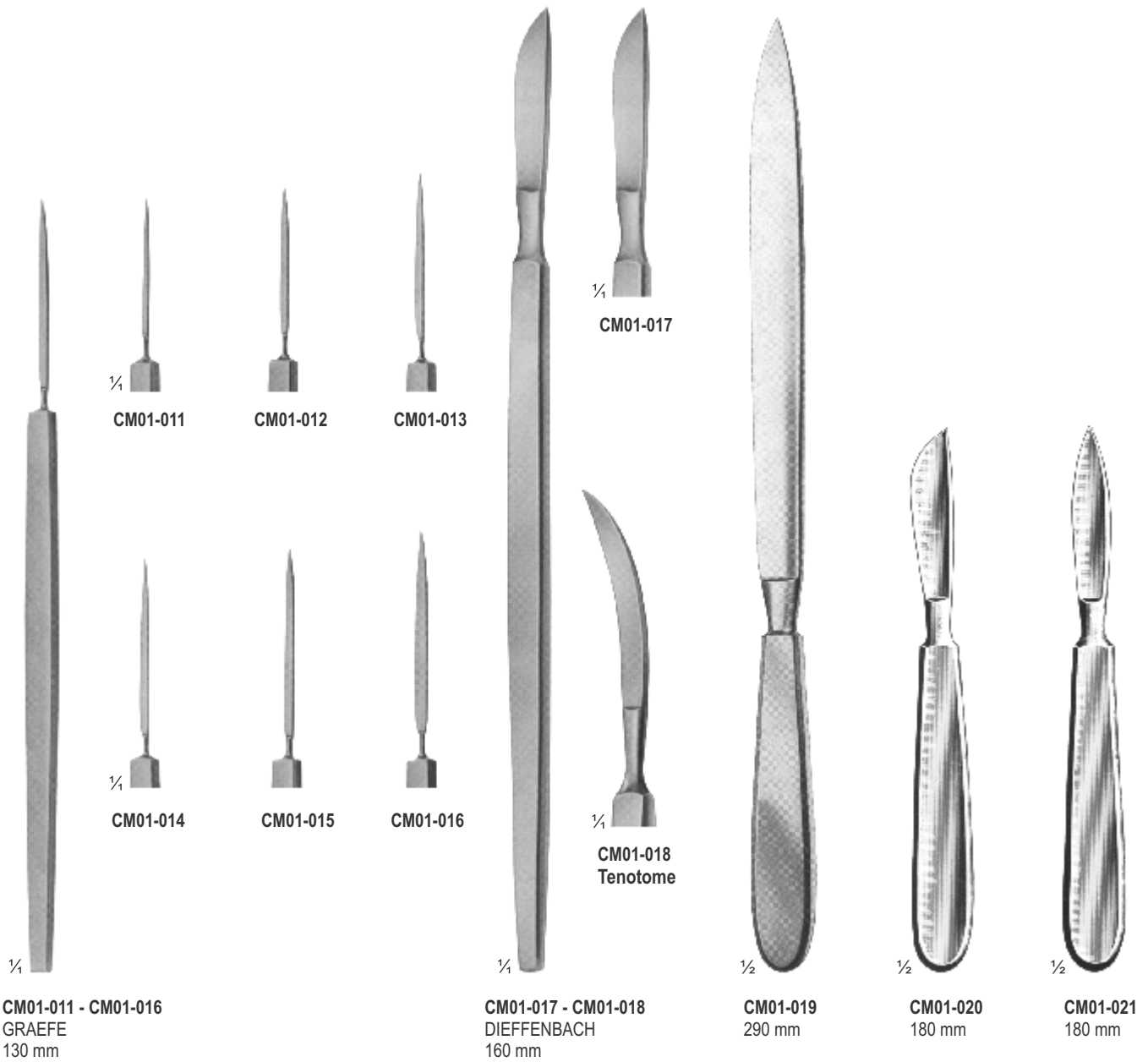

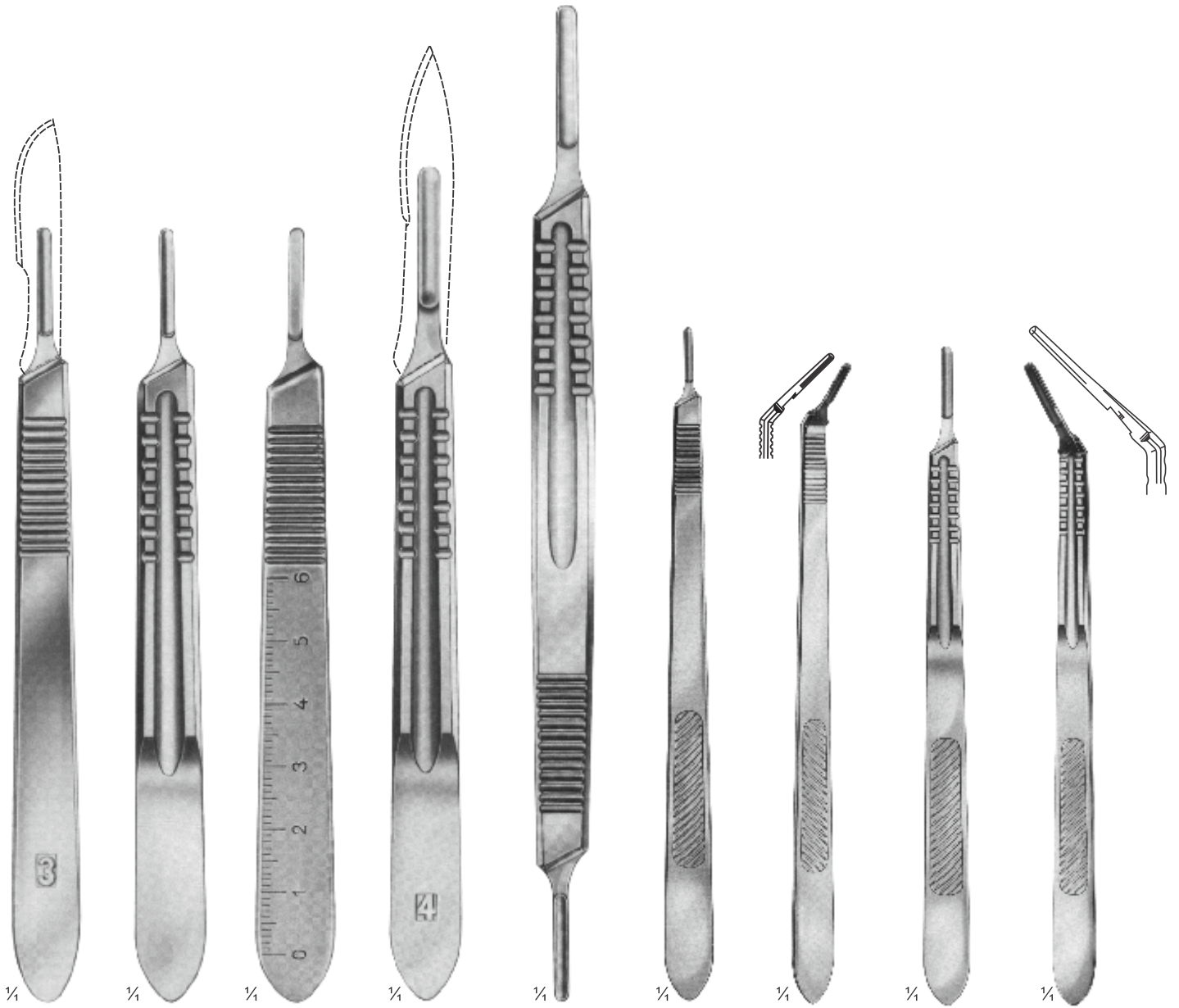

Standard
CM01-022
No. 3
12 cm
Solid

CM01-023
No. 3
12 cm
Solid

CM01-024
No. 3
12 cm
Solid

Standard
CM01-025
No. 4
13.5 cm
Solid

CM01-026
Double handle
No. 4 + No. 3
16 cm
Solid

CM01-027
No. 3 L
Straight
21.5 cm
Solid
Long

CM01-028
No. 3 L
Angled
20.5 cm
Solid
Long

CM01-029
No. 4 L
Straight
21 cm
Solid

CM01-030
No. 4 L
20.5 cm
Solid angled



CM01-031
No. 7
16 cm
Solid

CM01-032
No. 7 K
12.5 cm
Solid

CM01-033
No. 3
Hollow-Round
15.5 cm

CM01-034
No. 3
Straight
14 cm
Solid

CM01-035
No. 3
Angled
14 cm
Solid

Collin
CM01-036
No. 8
13.5 cm
Hollow

Collin
CM01-037
No. 9
14.5 cm
Hollow

Beaver
CM01-038
No. 3K
11.5 cm

CM01-039
No. 3KL
15.5 cm



HUBY
CM01-040
32 cm



HUBY
CM01-041



CM01-042
SCHINK
30 cm



SCHINK
CM01-142



CM01-043
SILVER
19.5 cm



CM01-044
PARKER



CM01-045

9.5 cm

11 cm



CM01-046
COBBETT



CM01-047
BRAITHWATTE



Spare Blade



CM01-048
HUMBY
35 cm

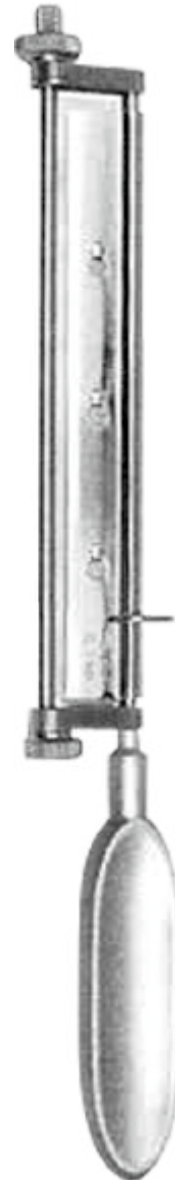

CM01-049
WATSON
30 cm

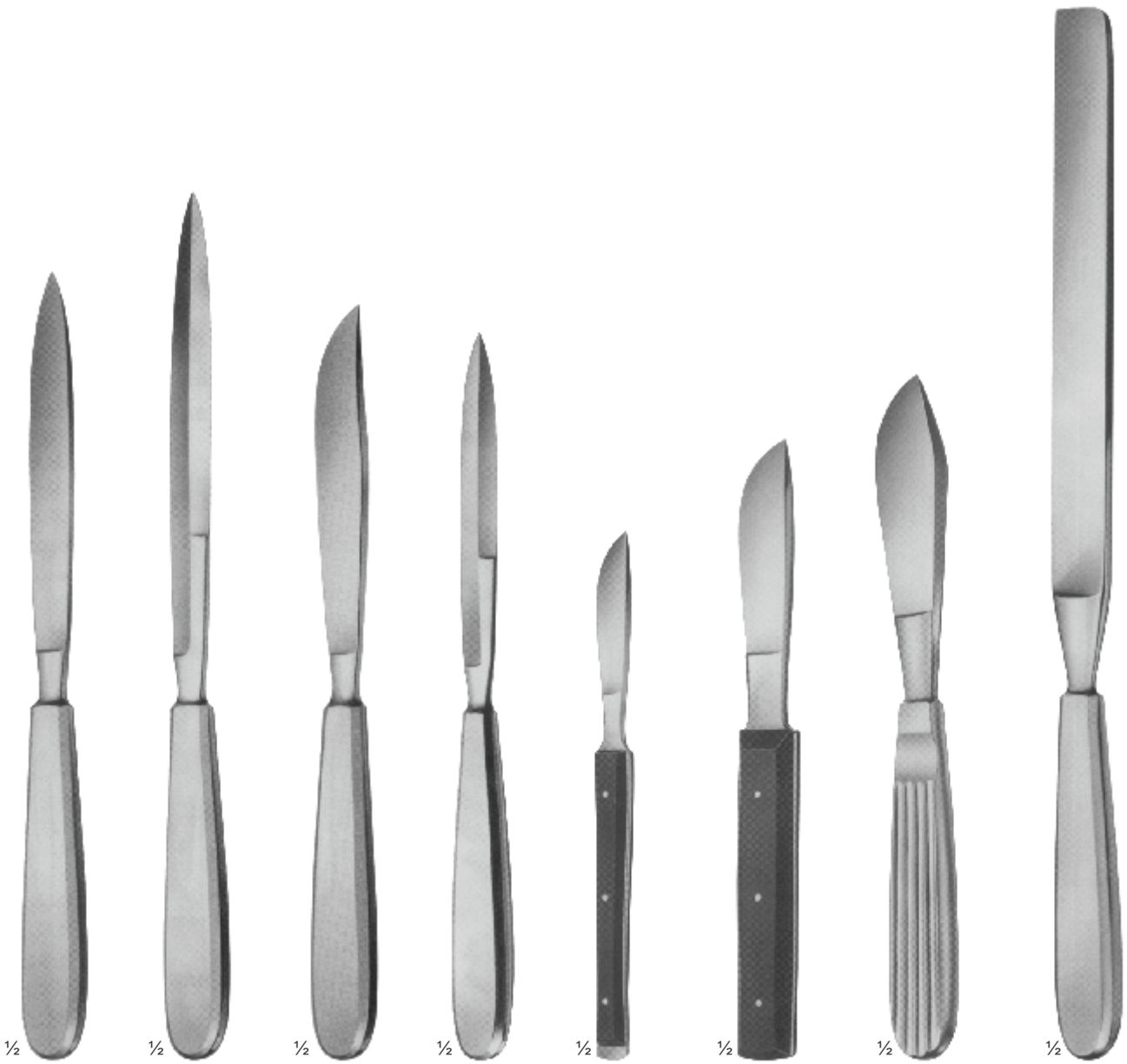

CM01-050
130 mm
CM01-051
160 mm
CM01-052
190 mm
CM01-053
200 mm

CM01-054
CATLIN
160 mm
Blade Length
Amputating
Knives

CM01-055
LANGENBECK
120 mm
Blade Length
Flap Knives

CM01-056
110 mm
Blade Length
Interosseous
Knives

CM01-057
55 mm
Blade Length
With Raspatory,
Wooden Handle

CM01-058
70 mm
Blade Length
Wooden Handle

CM01-059
80 mm
Blade Length
Metal Handle

CM01-060
195 mm
Blade Length
Metal Handle

Blade Length
Amputating Knives



CM01-061
AYRE
235 mm
Cone Knife

CM01-062
230 mm
Cone Knife

CM01-063
SEGOND
270 mm
Myomatome

CM01-064
OLIVECRONA
205 mm
Trigeminal

CM01-065
230 mm
Trigeminal
Knife

CM01-066
FOWLER
200 mm
Tonsil Knife

CM01-067
ABRAHAM
215 mm
Tonsil Knife

CM01-068
BRUNINGS
215 mm
Tonsil Knife

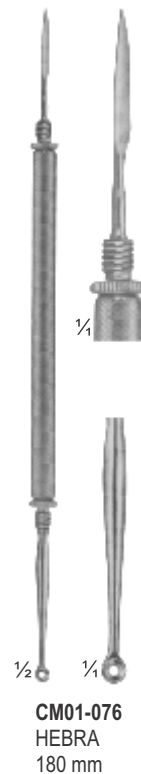
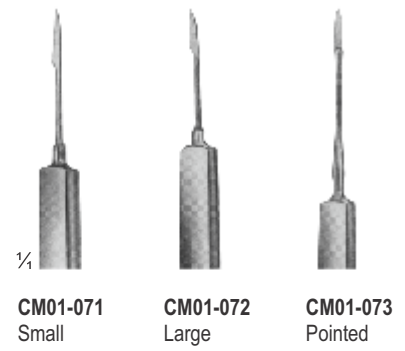
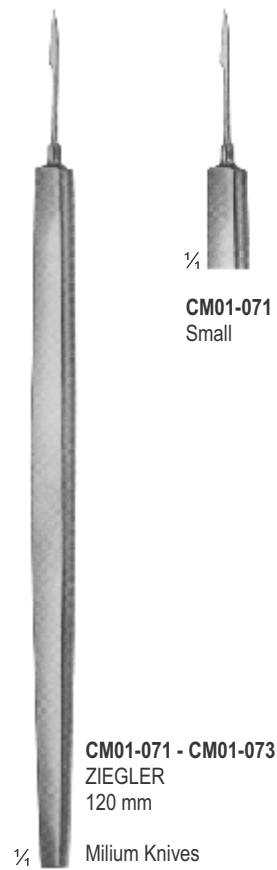
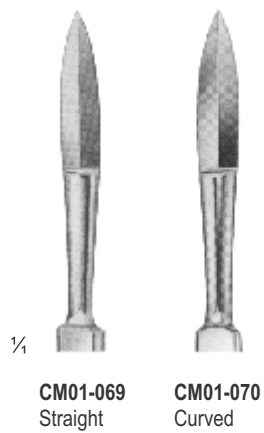

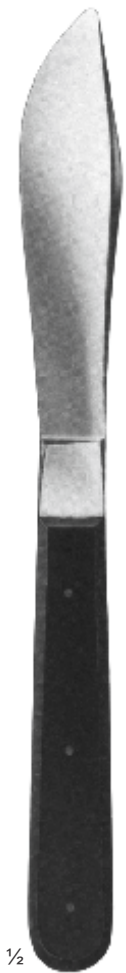

1/2

CM01-078
25.5 cm



CM01-079
VIRCHOW



CM01-080 - CM01-082
VIRCHOW

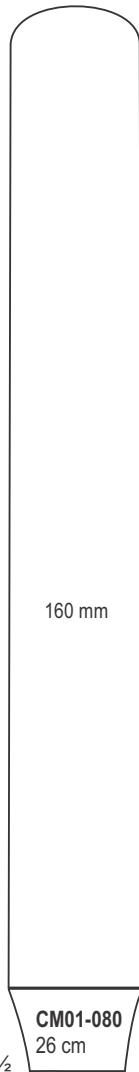

160 mm

CM01-080
26 cm

1/2

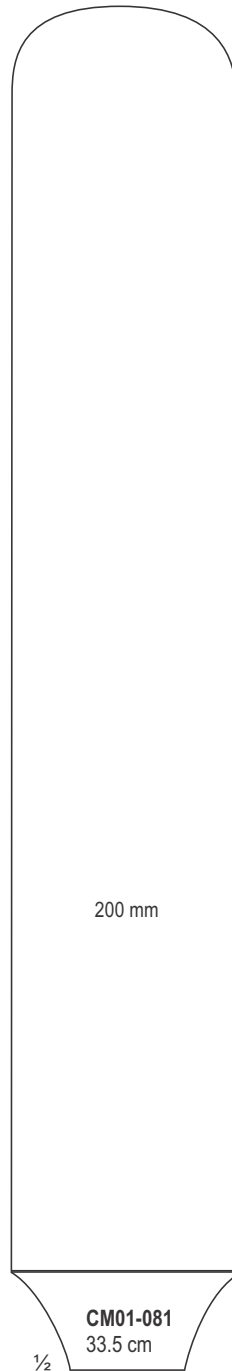

200 mm

CM01-081
33.5 cm

1/2

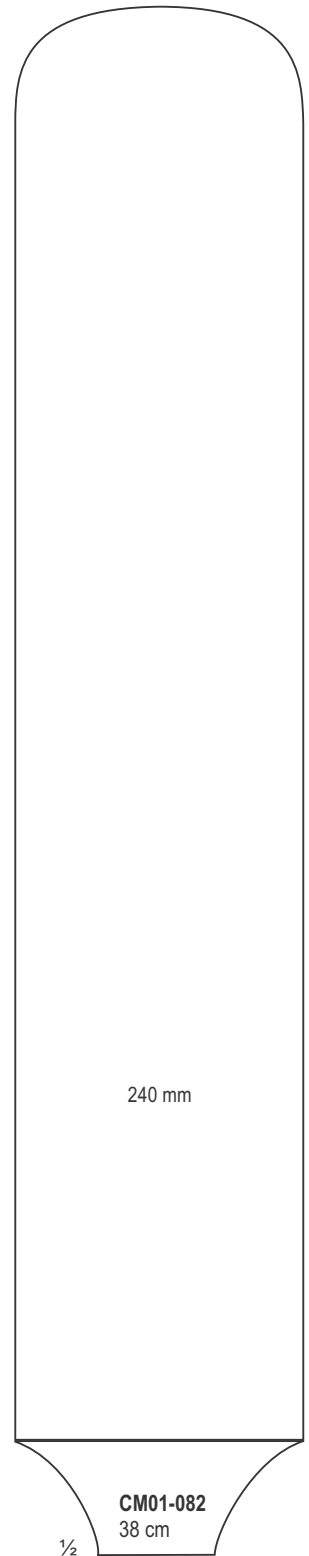

240 mm

CM01-082
38 cm

1/2



CARE MEDICAL[®]
SUPPLIES

Your health _ Our Priority

Section

02

Page 12-15

Preparation Instruments And Diagnostic Sets
Diagnostic Sets (laryngoscope)
Percussion Hammers & Aesthesiometers



CM02-001
Infants
150 mm



CM02-002
Children
200 mm



CM02-003
Adults
250 mm



CM02-001 - CM02-003
MAGILL



CM02-004
TUBING CLAMP
7", 8"
180 mm, 200 mm



CM02-005
Medium battery handle
only, 25 mm diam.



CM02-006
Spare bulb
2.7 volt, for
autosopes



CM02-007
Spare bulb
2.6 volt, for
ophthalmoscopes



CM02-008
Otoscope Set, Consists Of
Battery Handle Without Batteries,
3 Ear Specula, 1 Bulb In Velvet Lined Case

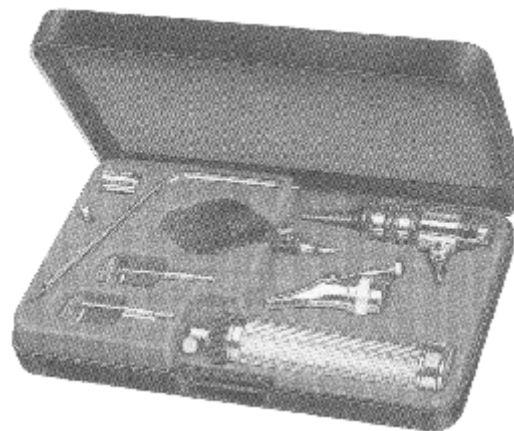

CM02-009
Diagnostic Set, Otoscope With Three Specula,
Nasal Speculam, Lamp Holder, Two Laryngeal
Mirrors, Tongue Blade Holder



1/3

CM02-010
MILLER
Laryngoscope Set, Consists Of Battery Handle
(Without Battery) With Four Miller
Laryngoscope Blades

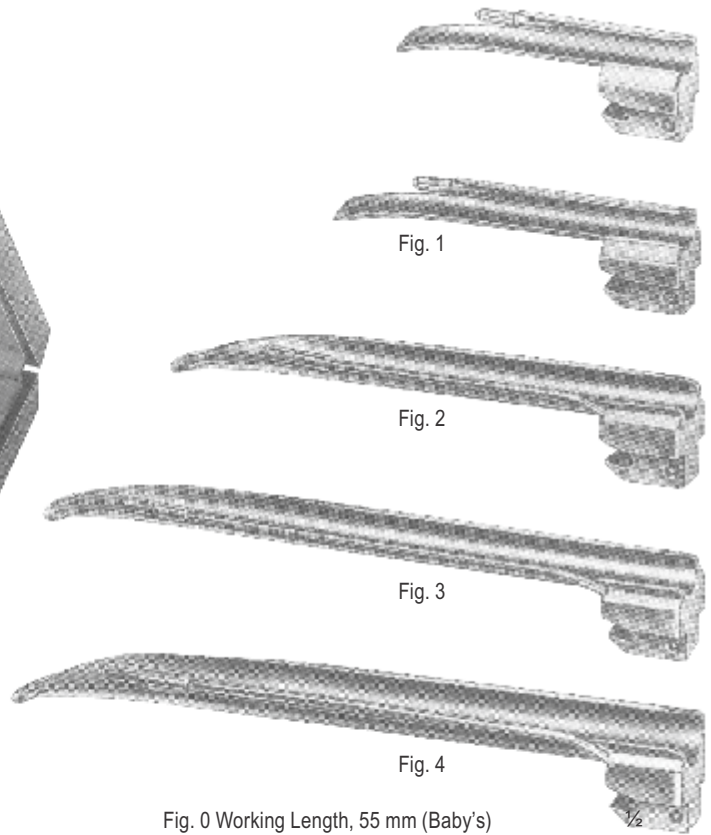

Fig. 1

Fig. 2

Fig. 3

Fig. 4

Fig. 0 Working Length, 55 mm (Baby's)
Fig. 1 Working Length, 80 mm (Children's)
Fig. 2 Working Length, 130 mm (Adolescent's)
Fig. 3 Working Length, 170 mm (Women's)
Fig. 4 Working Length, 180 mm (Men's)



1/3

CM02-011
GUEDEL-NEGUS
Laryngoscope Set, Consists Of Battery Handle
(Without Battery) With Four Miller
Laryngoscope Blades

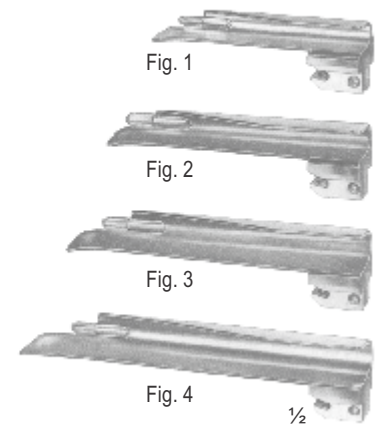

Fig. 1

Fig. 2

Fig. 3

Fig. 4

Fig. 1 Working Length, 70 mm (Children's)
Fig. 2 Working Length, 90 mm (Adolescent's)
Fig. 3 Working Length, 110 mm (Women's)
Fig. 4 Working Length, 135 mm (Men's)



CM02-012
McIntosh
Laryngoscope Set, Consists Of Battery Handle
(Without Battery) With Three McIntosh Blades,
Fig. 1, Fig. 2, Fig. 3

1/3

CM02-013
McIntosh
Laryngoscope Set, Consists Of Battery Handle (Without Battery)
With Five McIntosh Blades, Fig. 1, Fig. 2, Fig. 3, Fig. 4, Fig. 5

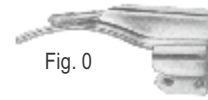

Fig. 0



Fig. 1



Fig. 2



Fig. 3

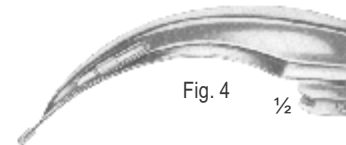
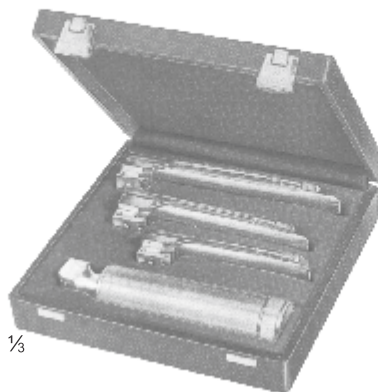

Fig. 4

1/2

Fig. 0 Working Length, 55 mm (Baby's)
Fig. 1 Working Length, 75 mm (Children's)
Fig. 2 Working Length, 90 mm (Adolescent's)
Fig. 3 Working Length, 110 mm (Women's)
Fig. 4 Working Length, 135 mm (Men's)



CM02-014
6GER
Laryngoscope Set, Consists Of
Battery Handle (Without Battery)
With Three Foregger Blades,
Fig. 1, Fig. 2, Fig. 3,

1/3

CM02-015
FOREGGER
Laryngoscope Set, Consists Of
Battery Handle (Without Battery)
With Five Foregger Blades,
Fig. 1, Fig. 2, Fig. 3, Fig. 4, Fig. 5



Fig. 1

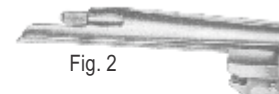

Fig. 2

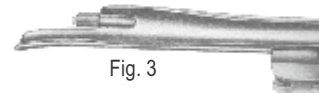

Fig. 3

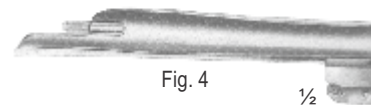

Fig. 4

1/2

Fig. 1 Working Length, 70 mm (Children's)
Fig. 2 Working Length, 90 mm (Adolescent's)
Fig. 3 Working Length, 110 mm (Women's)
Fig. 4 Working Length, 135 mm (Men's)



1/2

CM02-016
Fiber Optic
Battery Handle



1/2

CM02-017
Fiber Optic
Battery Handle



1/4

CM02-018
Replacement Lamp
(Krypton) 2.5 V



1/4

CM02-019
Replacement Lamp
(Halogen) 2.5 V

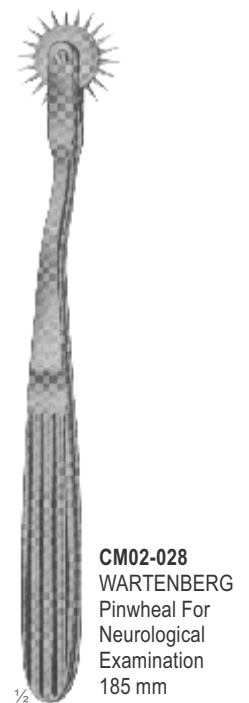
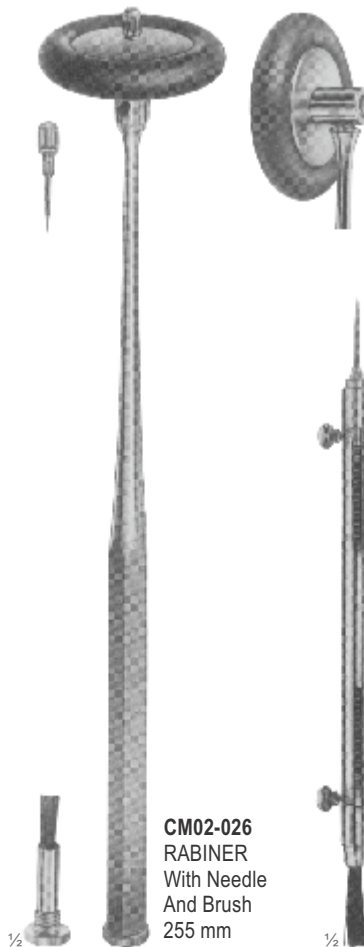
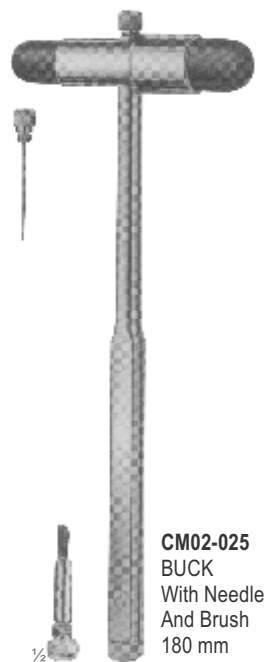
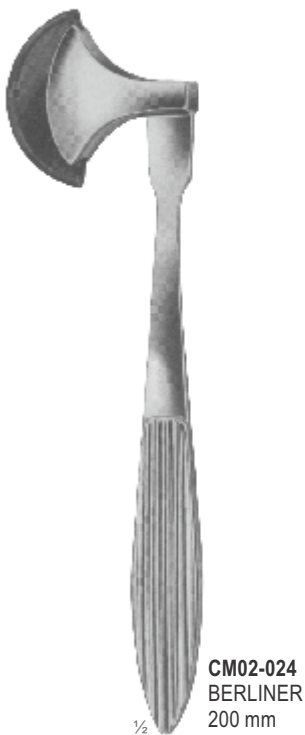





CARE MEDICAL[®]
SUPPLIES

Your health _ Our Priority

Section

03

Page 16-20

Tongue Depressors
Instruments For Anaesthesia And Tongue Forceps
Examination & Measuring Instruments
Razor Blade Holders & Breakers

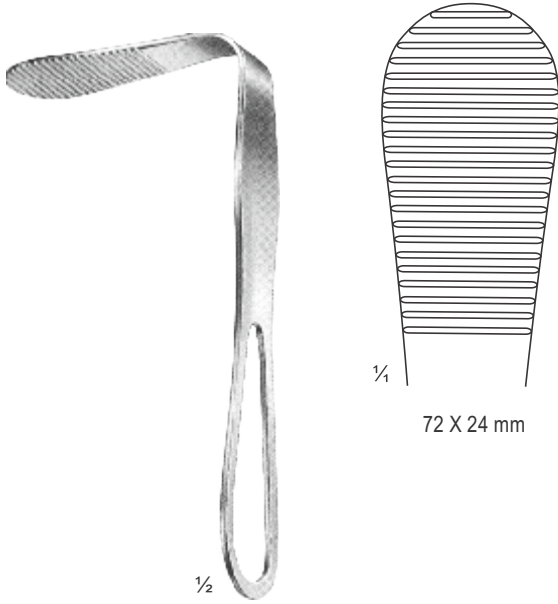

CM03-001
HARTMANN
150 mm



CM03-002
TOBOLD
150 mm

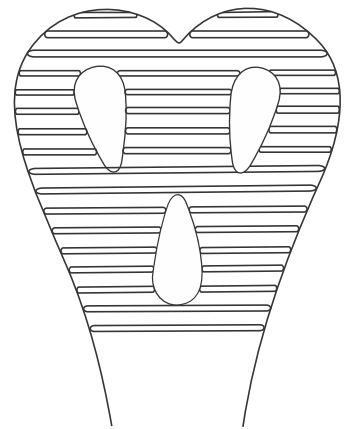

CM03-004
15 cm
43 mm



CM03-003
TOBOLD
160 mm



CM03-004 - CM03-005
WIEDER

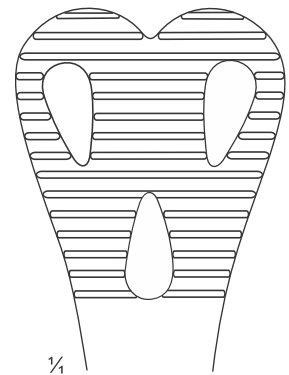

CM03-005
140 mm
36 mm

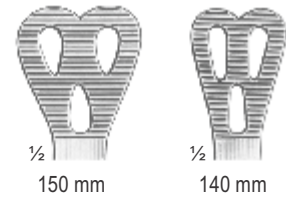
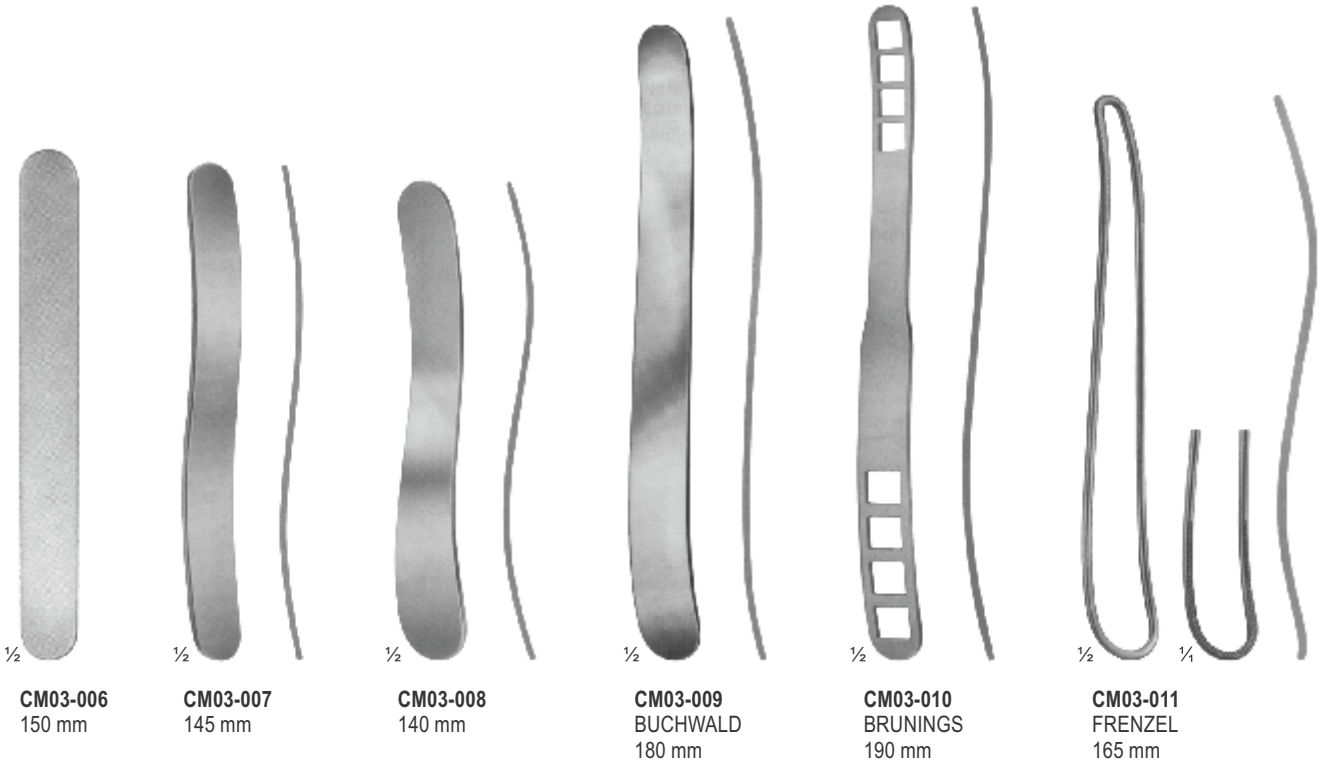



1/2

CM03-017
HEISTER
Mouth Gag
Size: 130 mm



1/2

CM03-018
FERGUSSON-ACKLAND
Mouth Gag
Size: 145 mm



1/2

CM03-019
DENHARDT
Mouth Gag With Silicon
Inserts, Interchangeable
Size: 125 mm



1/2

CM03-020
ROSER KONIG
Mouth Gag
Size: 160 mm,
185 mm

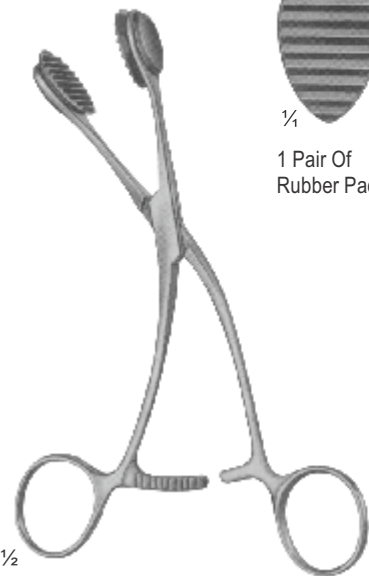

1/2

CM03-021
YOUNG
165 mm



1/4

1 Pair Of
Rubber Pads

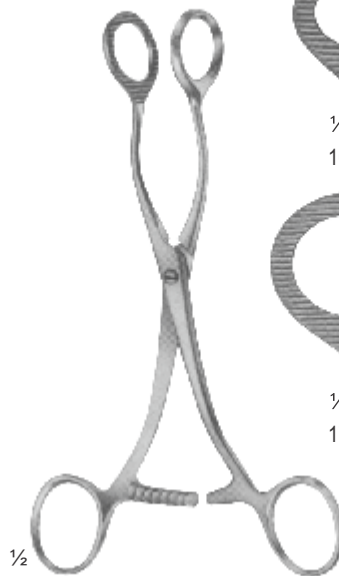

1/2

CM03-022
COLLIN
160 mm, 170 mm



1/4

160 mm



1/4

170 mm

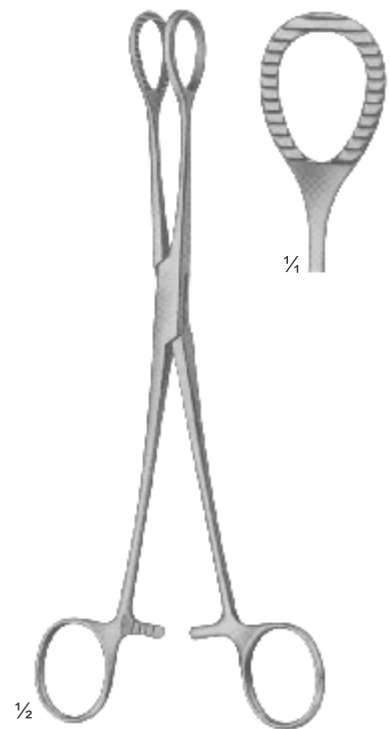

1/2

CM03-023
HEYWOOD-SMITH modif.
215 mm



1/4



CM03-024
Boley



Metal: **CM03-025**
Wax : **CM03-026**
Double Side Marking
Iwanson



CM03-027
CAROLL
140 mm



CM03-028
TOWNLEY
100 mm



CM03-029
BERTILLON
Caliper For Measuring The Head
320 mm

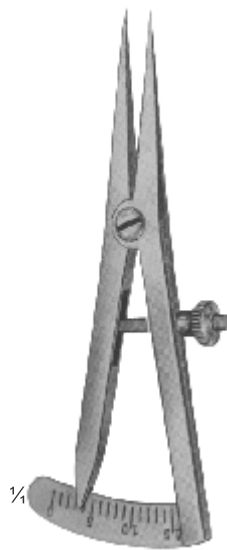

CM03-030
CASTROVIEJO
Caliper



CM03-031
MOLTGEN
Goniometer



¼

CM03-032
TROUTMAN-CHRIS
9 cm



¼

CM03-033
TROUTMAN-CHRIS
9 cm



¼

CM03-034
11 cm



¼

CM03-035
CASTROVIEJO
13 cm



¼

CM03-036
18.5 cm



CARE MEDICAL[®]
SUPPLIES

Your health _ Our Priority

Section

04

Page 21-68

Surgical Scissors
Dissecting & Surgical Scissors
Operating And Gynaecology Scissors
Percussion Hammers & Aesthesiometers
Dissecting And Operating Scissors With Tungsten Carbide
Ligature Scissors With Tungsten Carbide And Super-cut Edges
Delicate, Nasal And Tonsil Scissors
Bandage, Cloth And Plaster Scissors

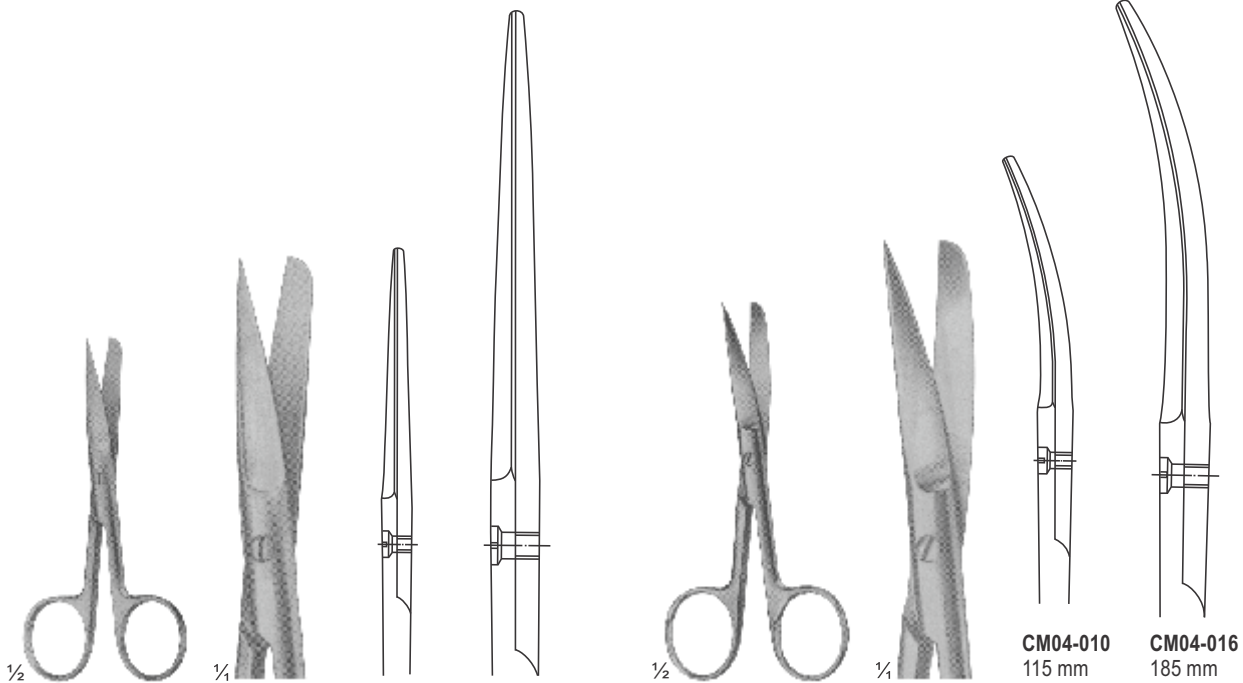

CM04-001 - CM04-009 (Standard Types)
CM04-001 (105 mm)
CM04-002 (115 mm)
CM04-003 (130 mm)
CM04-004 (145 mm)
CM04-005 (150 mm)
CM04-006 (165 mm)
CM04-007 (175 mm)
CM04-008 (185 mm)
CM04-009 (200 mm)

CM04-001
105 mm

CM04-009
200 mm

CM04-010 - 095 (Standard Types)
CM04-010 (115 mm)
CM04-011 (130 mm)
CM04-012 (145 mm)
CM04-013 (150 mm)
CM04-014 (165 mm)
CM04-015 (175 mm)
CM04-016 (185 mm)

CM04-010
115 mm

CM04-016
185 mm

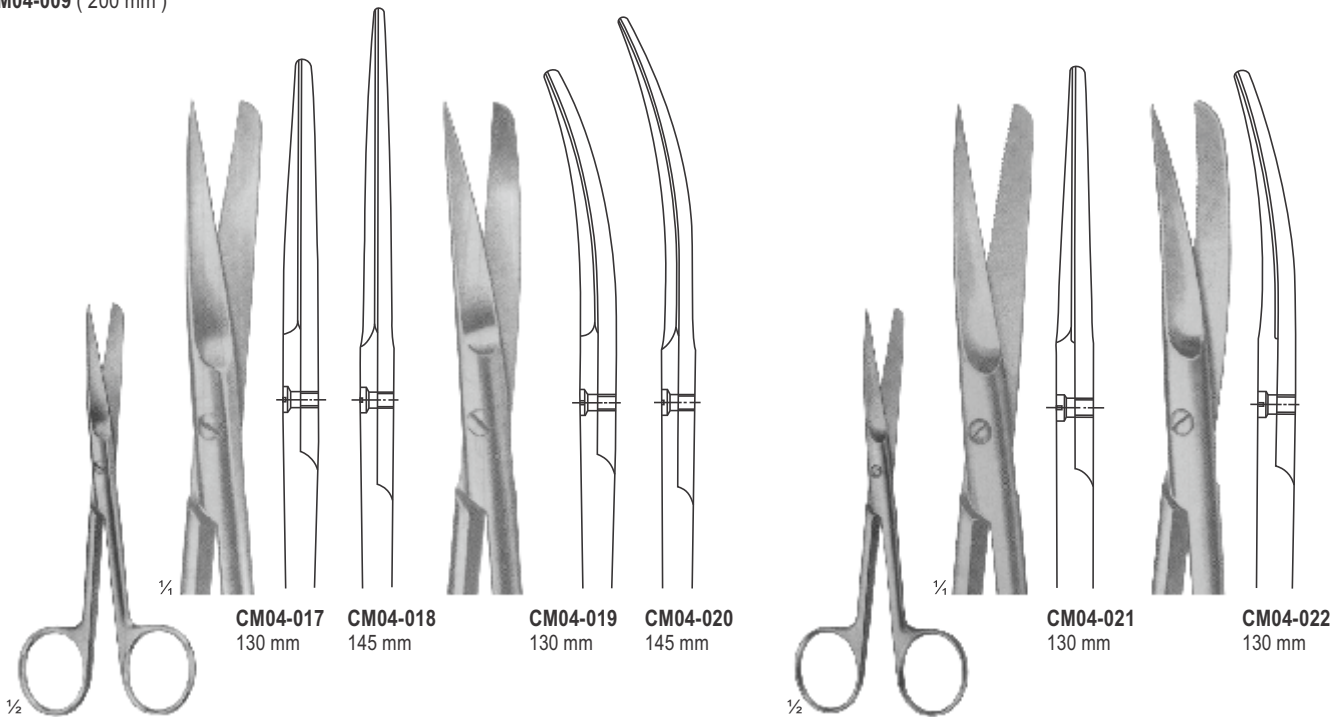

CM04-017 - CM04-018
Slender Types

CM04-017
130 mm

CM04-018
145 mm

CM04-019
130 mm

CM04-020
145 mm

CM04-021 - CM04-022
For Wound Edges
1 Blade Serrated

CM04-021
130 mm

CM04-022
130 mm

CM04-021
130 mm

CM04-022
130 mm

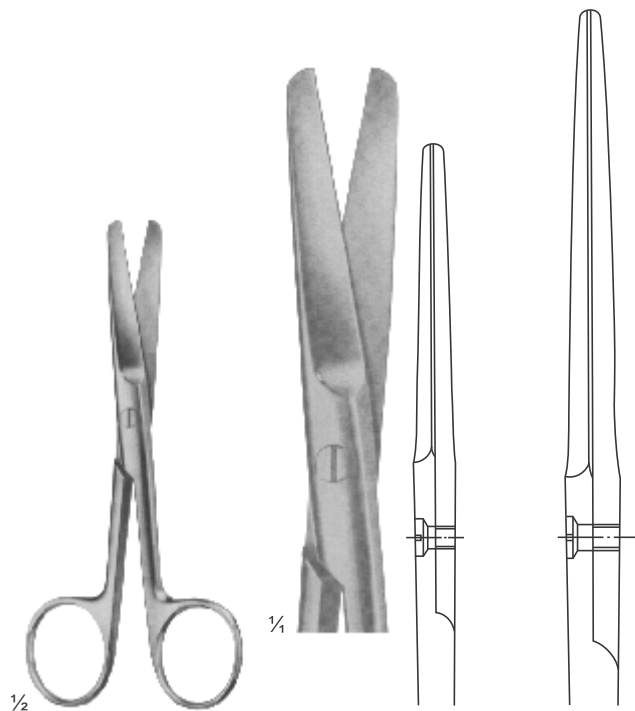

CM04-023 - 107 (Standard Types)
CM04-023 (130 mm)
CM04-024 (145 mm)
CM04-025 (150 mm)
CM04-026 (165 mm)
CM04-027 (175 mm)

CM04-023
 130 mm

CM04-027
 175 mm

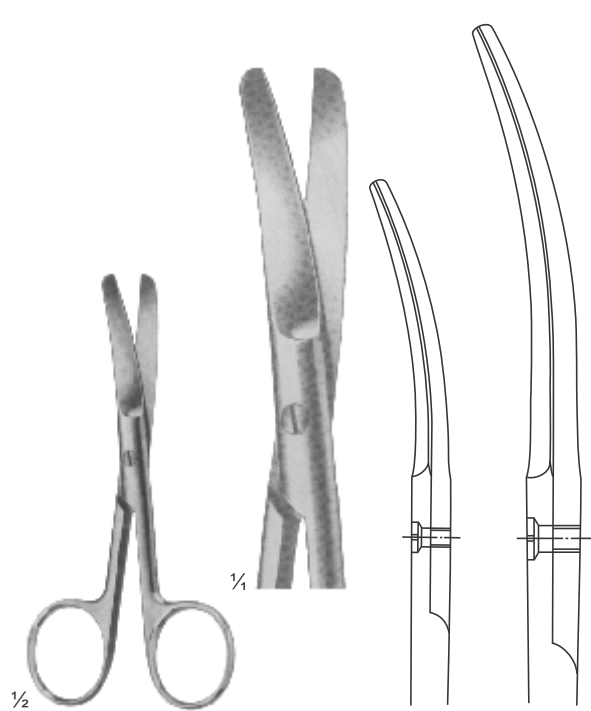

CM04-028 - 113 - COOPER
 Standard Types
CM04-028 (115 mm)
CM04-029 (130 mm)
CM04-030 (145 mm)
CM04-031 (150 mm)
CM04-032 (165 mm)
CM04-033 (175 mm)

CM04-028
 115 mm

CM04-033
 175 mm

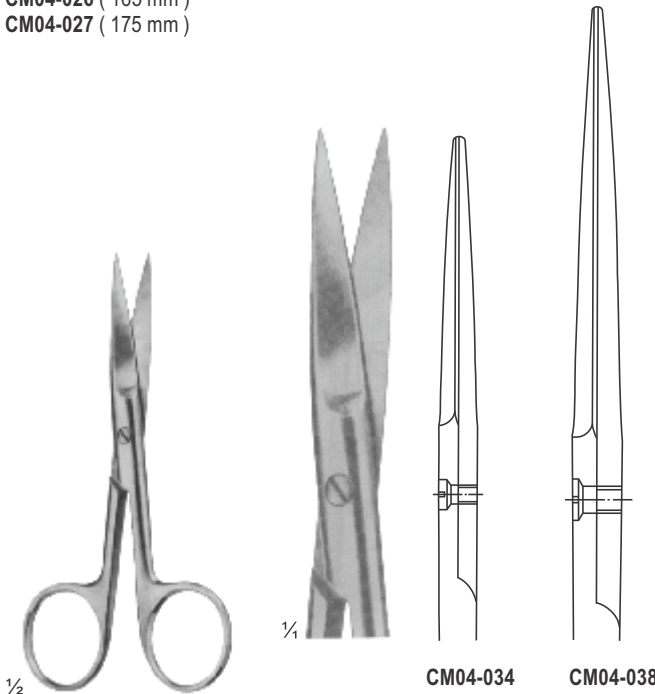

CM04-034 - CM04-038
 Standard Types
CM04-034 (115 mm)
CM04-035 (130 mm)
CM04-036 (145 mm)
CM04-037 (150 mm)
CM04-038 (165 mm)

CM04-034
 115 mm

CM04-038
 165 mm

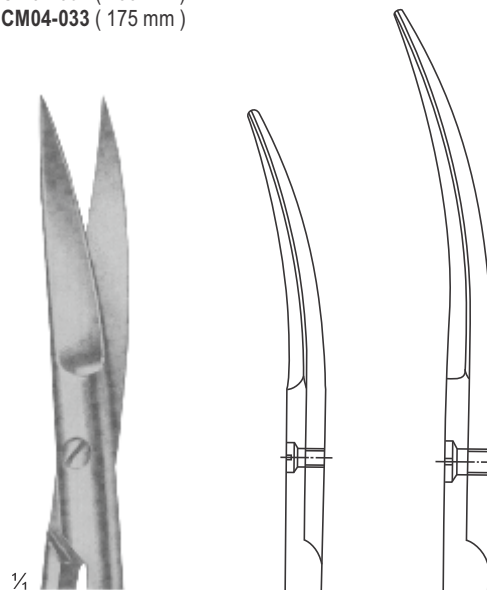

CM04-039 - 121
 Standard Types
CM04-039 (115 mm)
CM04-040 (130 mm)
CM04-041 (145 mm)
CM04-042 (150 mm)

CM04-039
 115 mm

CM04-042
 150 mm

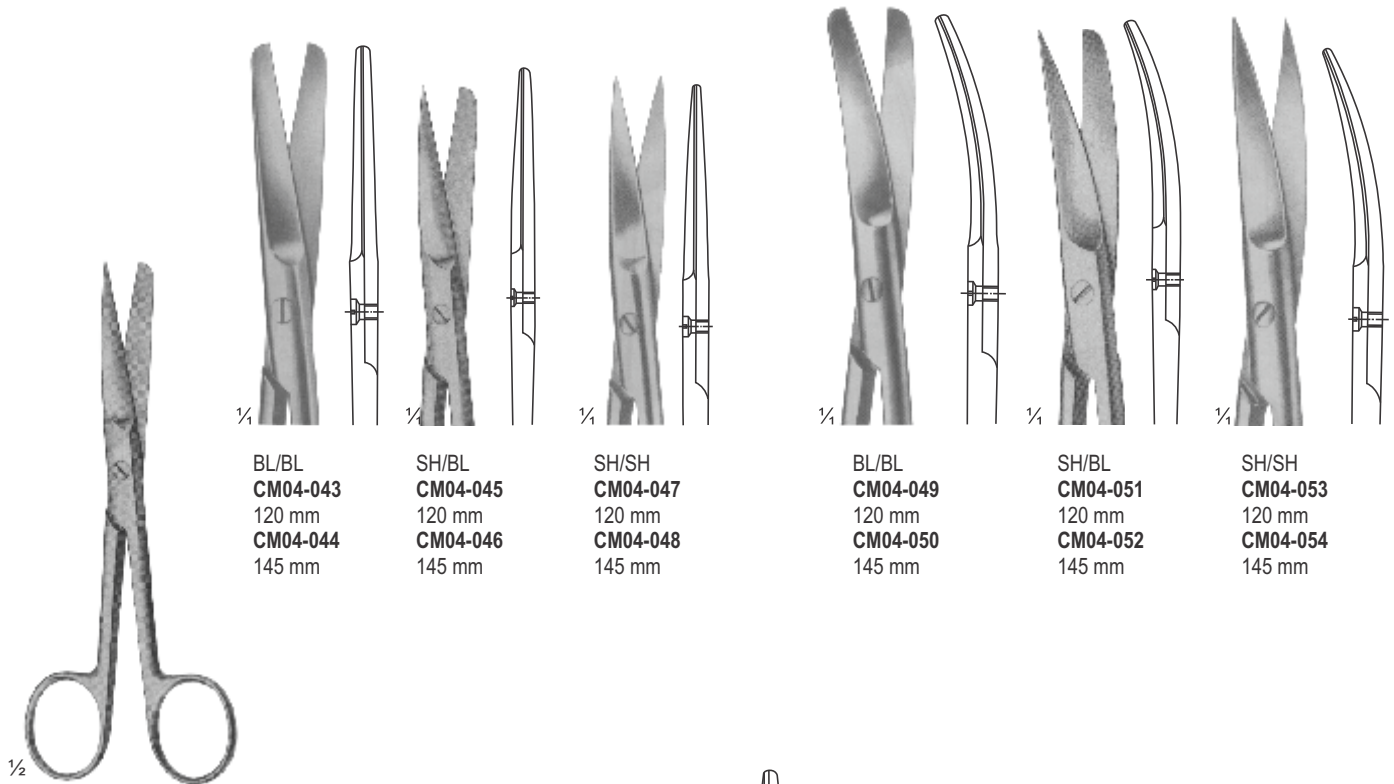

BL/BL
CM04-043
120 mm
CM04-044
145 mm

SH/BL
CM04-045
120 mm
CM04-046
145 mm

SH/SH
CM04-047
120 mm
CM04-048
145 mm

BL/BL
CM04-049
120 mm
CM04-050
145 mm

SH/BL
CM04-051
120 mm
CM04-052
145 mm

SH/SH
CM04-053
120 mm
CM04-054
145 mm

CM04-043 - VI-04-054
DEAVER
With flat lock

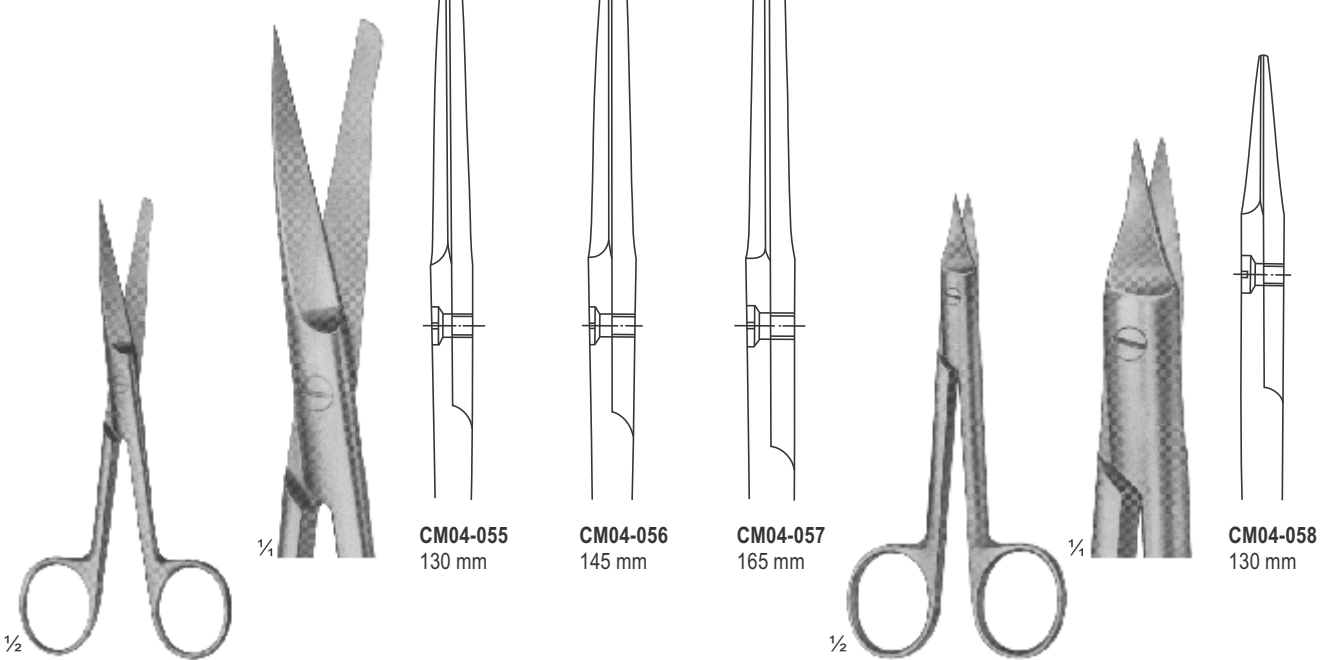

CM04-055
130 mm

CM04-056
145 mm

CM04-057
165 mm

CM04-058
130 mm

CM04-055 - CM04-057
Incision Scissors

CM04-058
SYSTRUNK
Nail Splitting Scissors

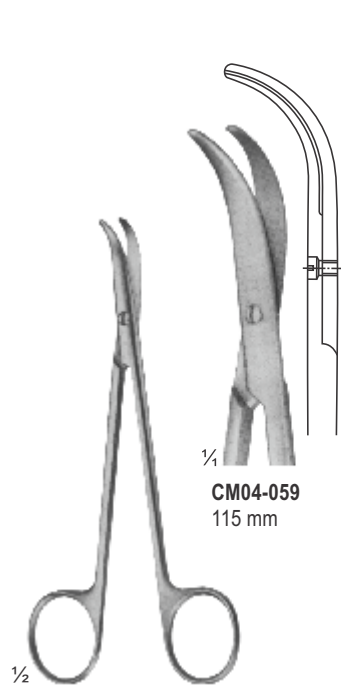

CM04-059
115 mm

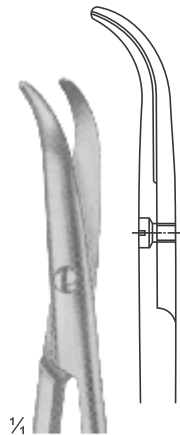

CM04-060
135 mm

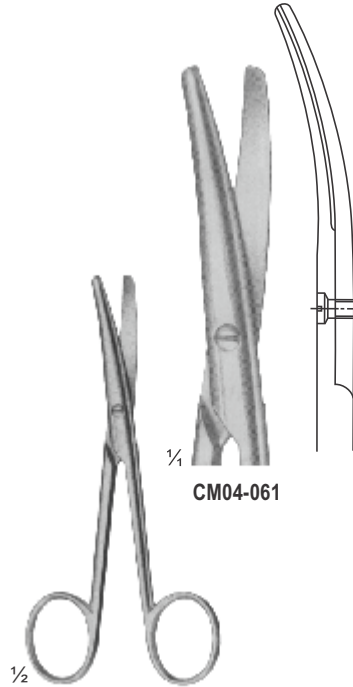

CM04-061

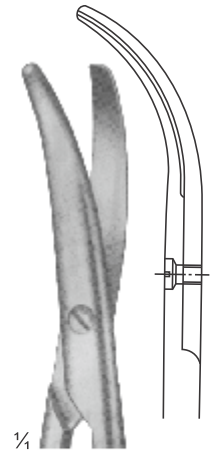

CM04-062

CM04-059 - CM04-060
FOMON
Lower lateral scissors

CM04-061 - CM04-062
LANDOLT
Enucleation scissors
120 mm

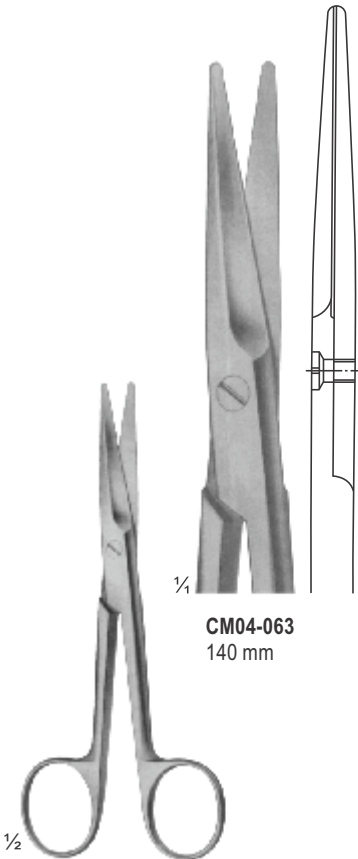

CM04-063
140 mm

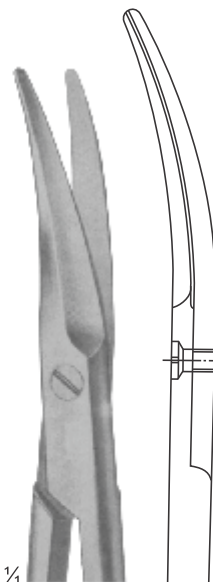

CM04-066 - CM04-068
MAYO
CM04-066 (140 mm)
CM04-067 (155 mm)
CM04-068 (170 mm)

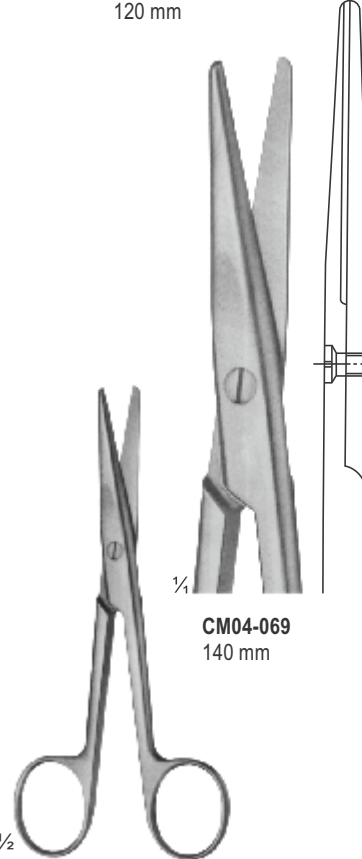

CM04-069
140 mm

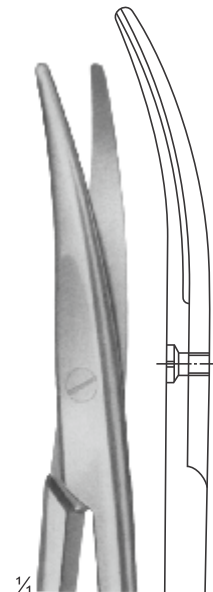

CM04-071 - CM04-072
MAYO-STILLE
CM04-071 (140 mm)
CM04-072 (170 mm)

CM04-063 - CM04-066
MAYO
CM04-063 (140 mm)
CM04-064 (155 mm)
CM04-065 (170 mm)

CM04-069 - CM04-070
MAYO-STILLE
CM04-069 (140 mm)
CM04-070 (170 mm)

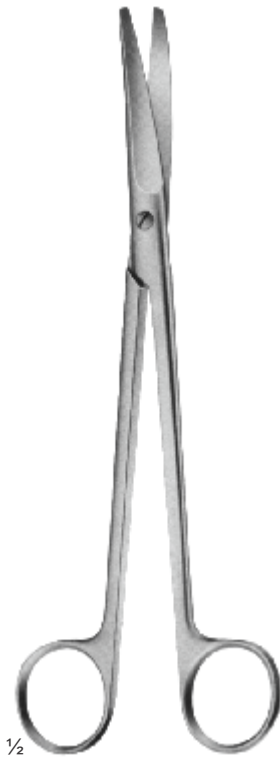

SIMS
CM04-073 - CM04-075
CM04-073 200 mm
CM04-074 210 mm
CM04-075 230 mm



Curved



WERTHEIM
CM04-076 - CM04-078
CM04-076 145 mm
CM04-077 200 mm
CM04-078 230 mm

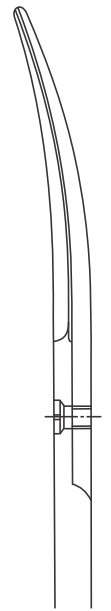

Curved

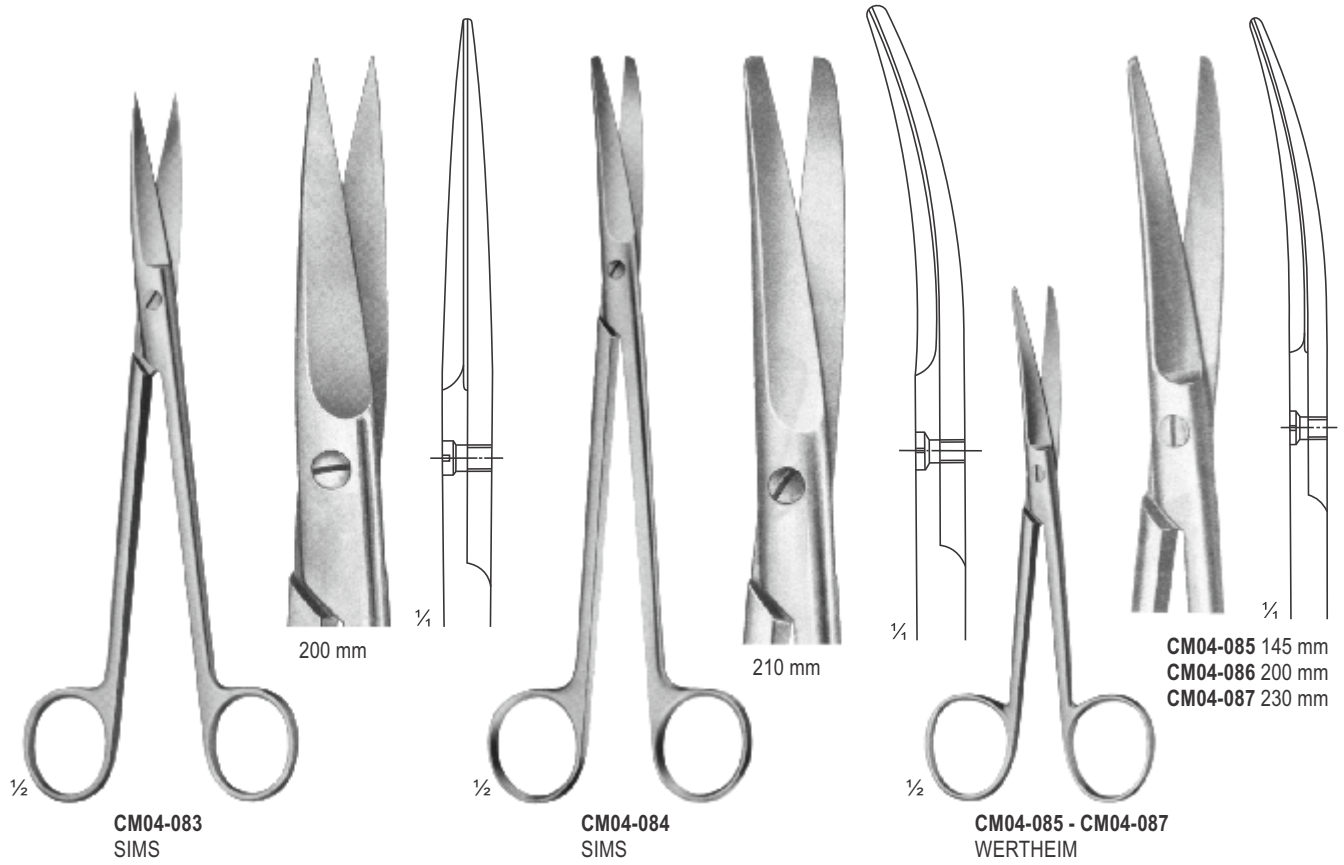
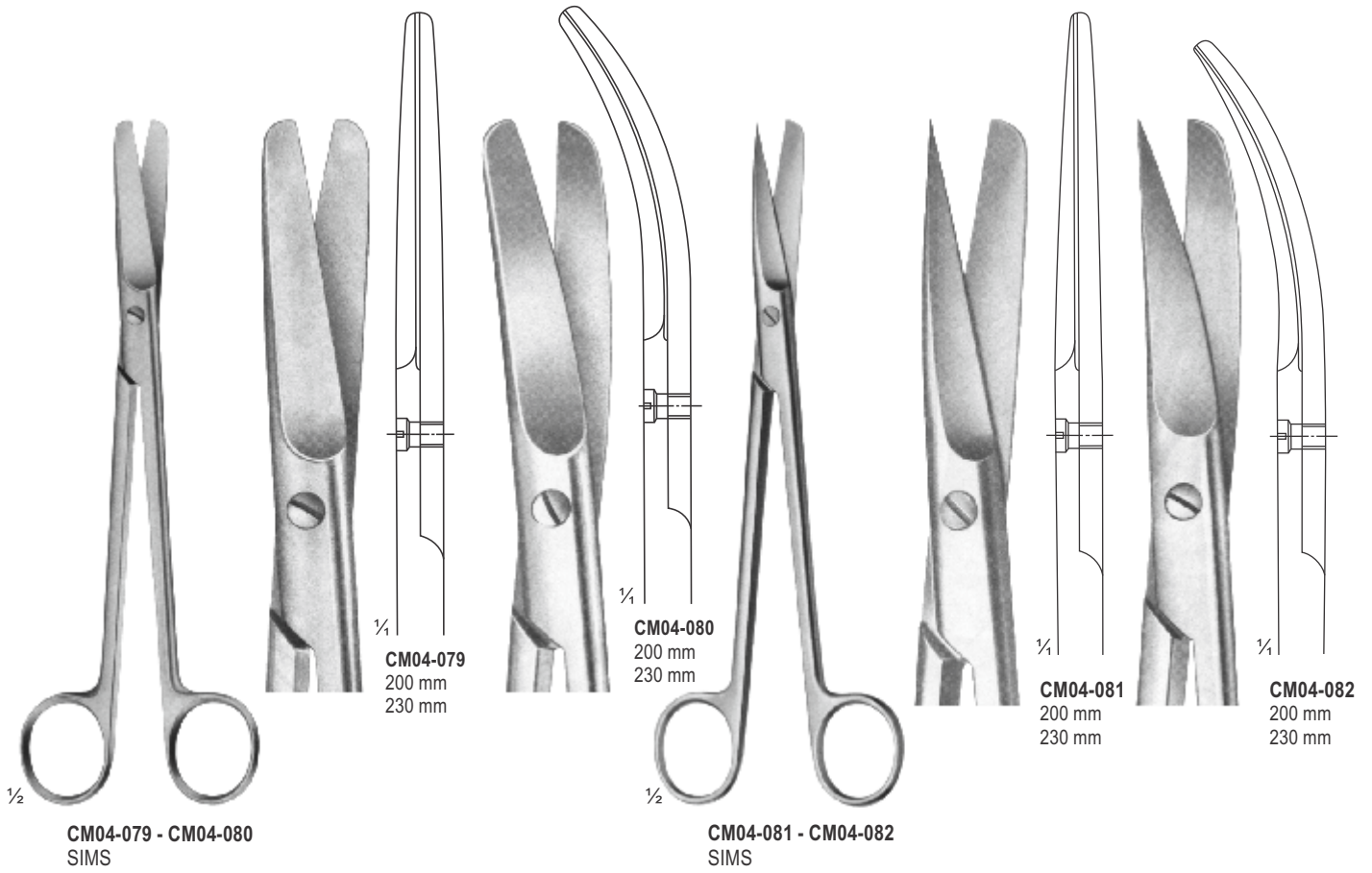



SIEBOLD
CM04-088
Uterine Scissors
24.5 cm

BOZEMANN
CM04-089
Uterine Scissors
22 cm

SIMS-SIEBOLD
CM04-090
Uterine Scissors
25 cm



CM04-091
CLOTH SCISSORS
205 mm

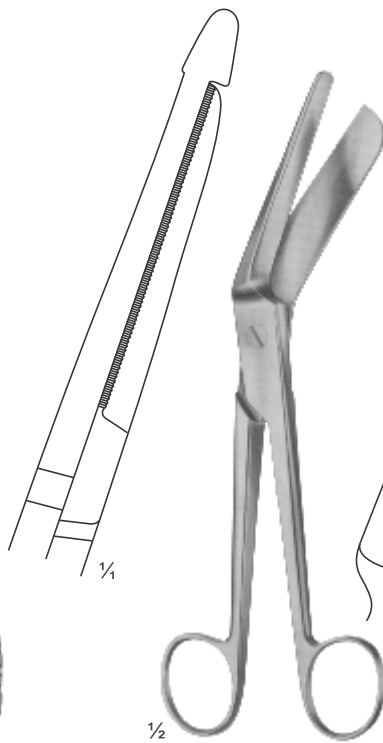

CM04-092
BRAUN-STADLER
225 mm

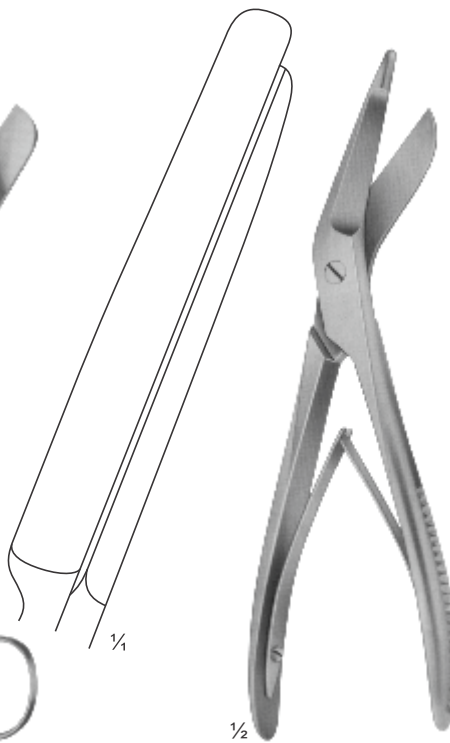

CM04-093
SEUTIN
230 mm

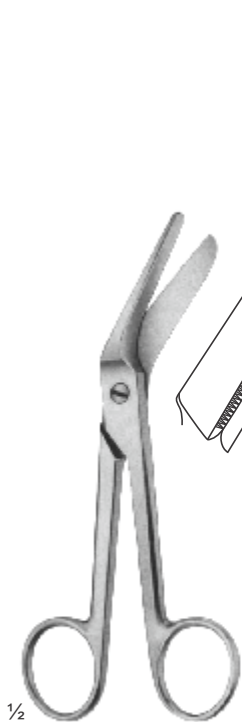

CM04-094 - CM04-095
BRAUN-STADLER
Empisiotomy Scissors

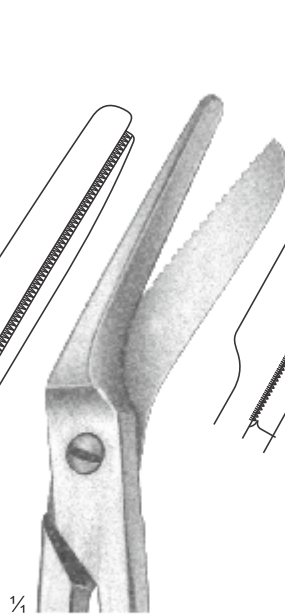

CM04-094
145 mm

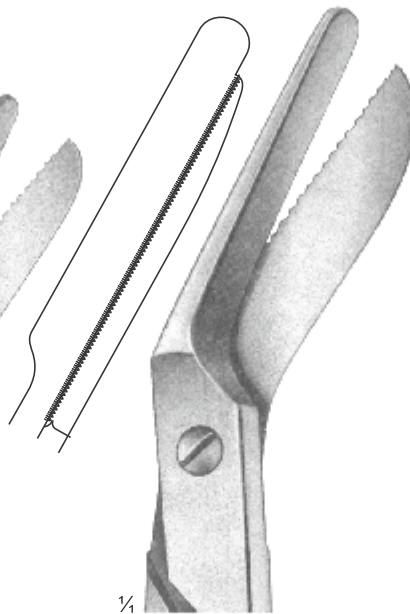

CM04-095
200 mm

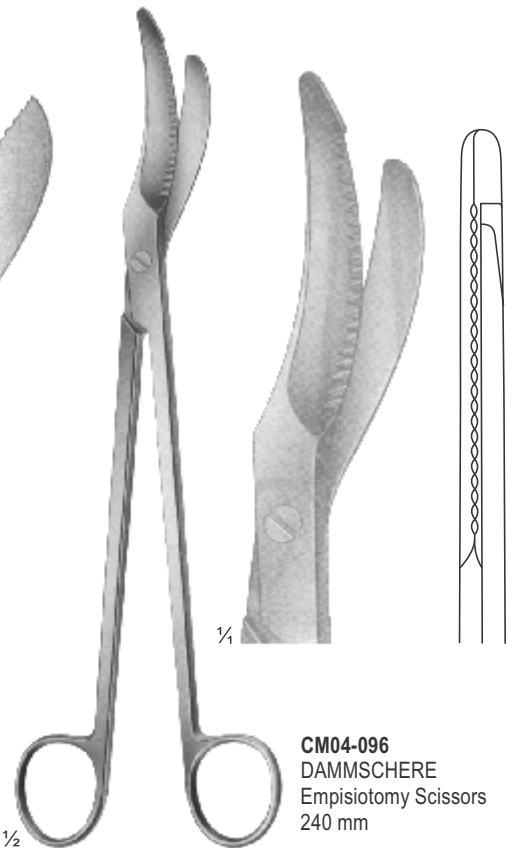

CM04-096
DAMMSCHERE
Empisiotomy Scissors
240 mm

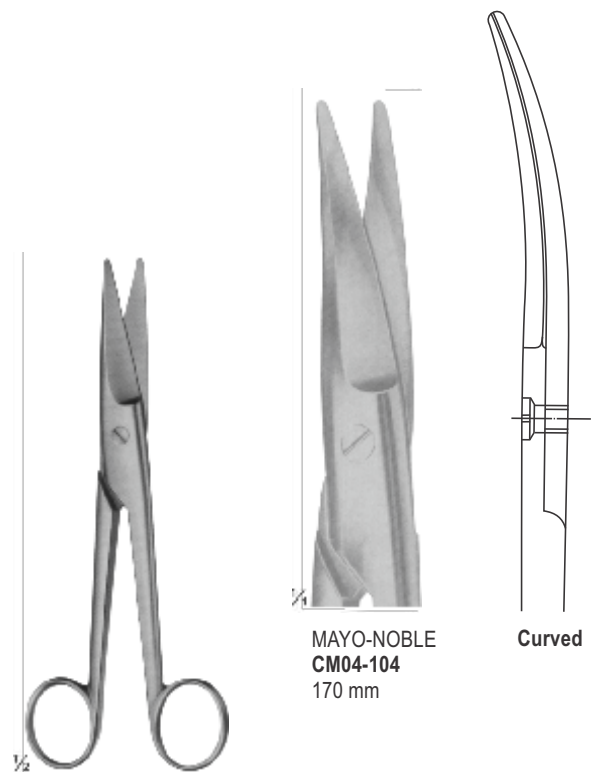
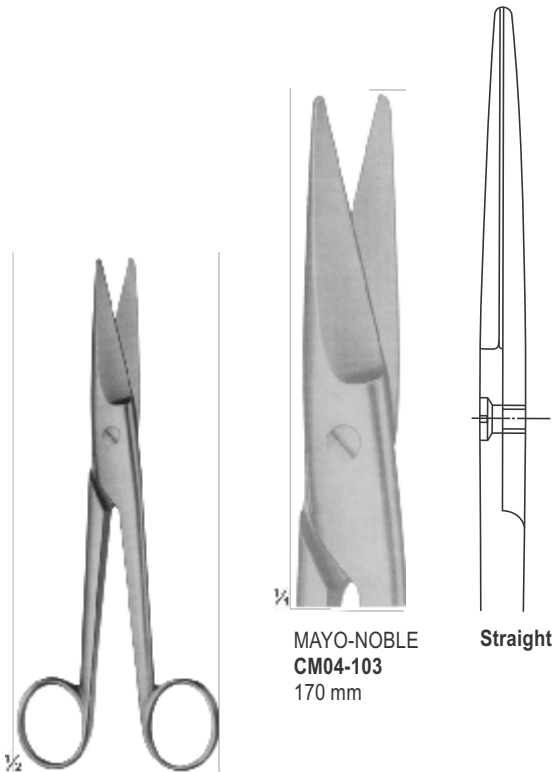
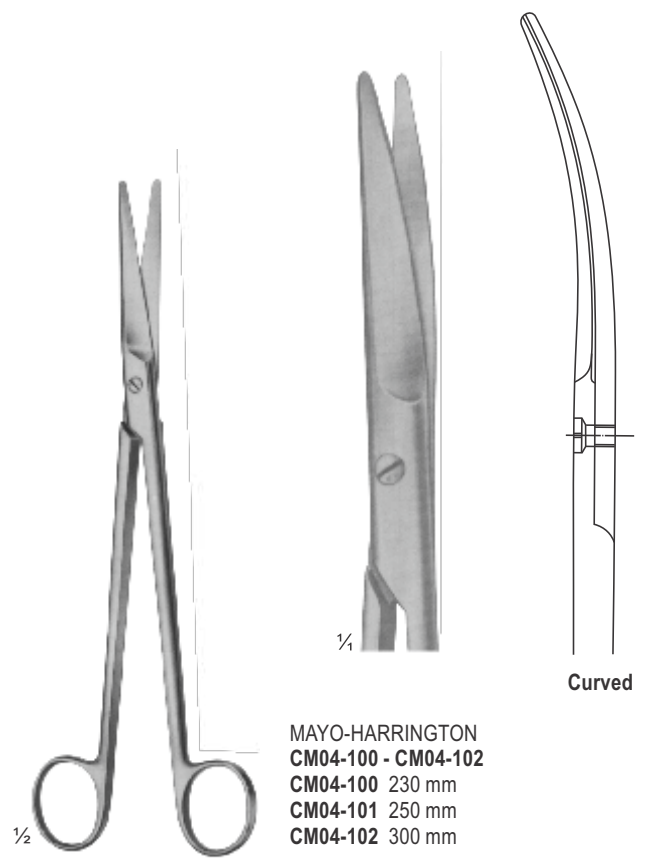
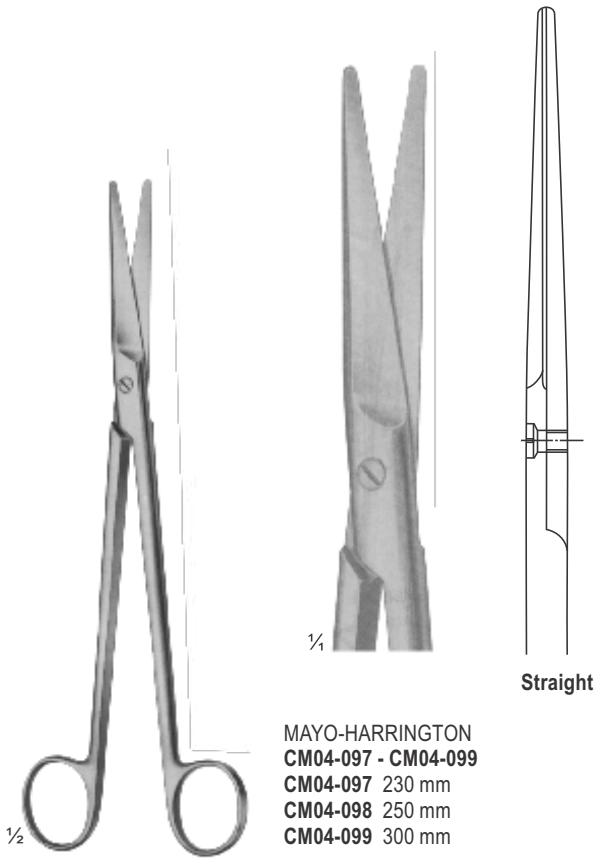

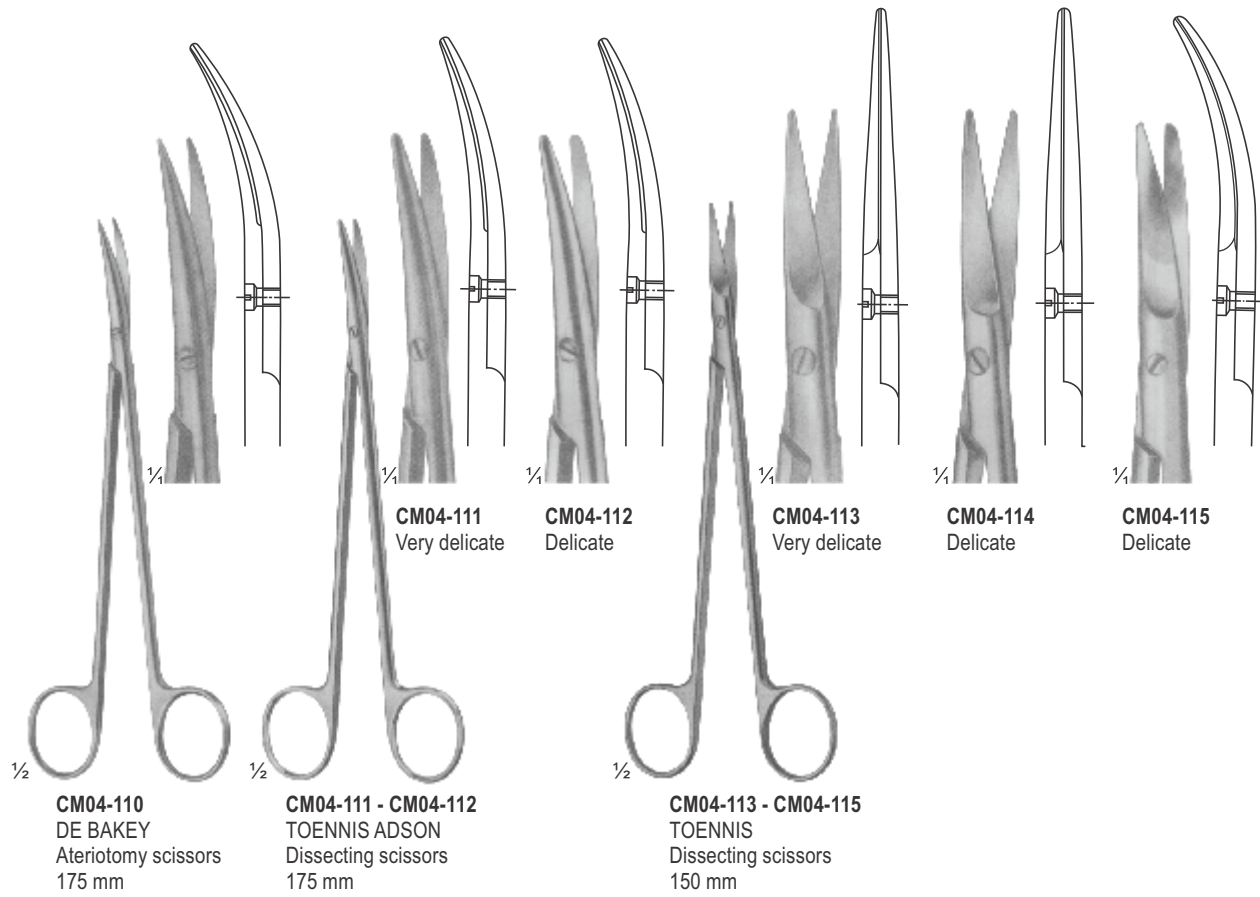
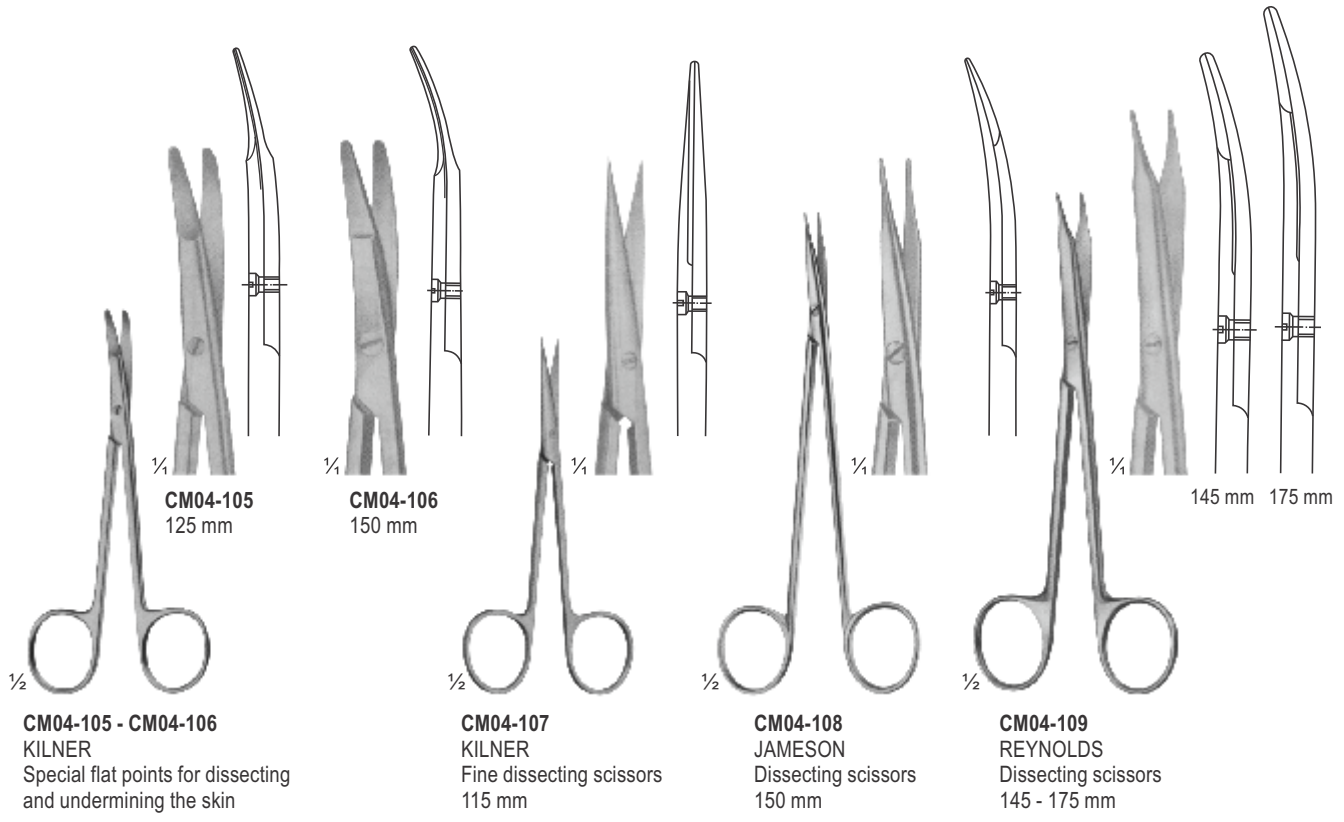

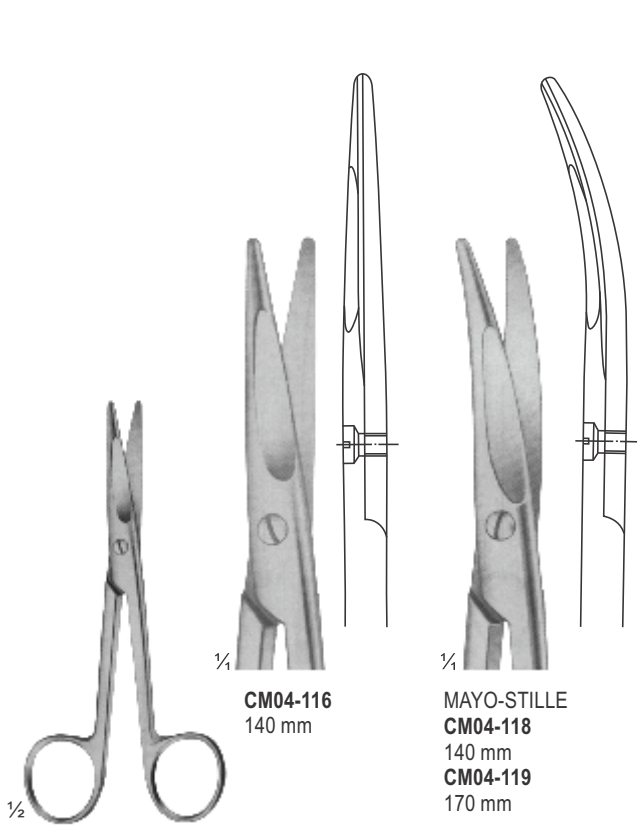

CM04-116
140 mm

MAYO-STILLE
CM04-118
140 mm
CM04-119
170 mm

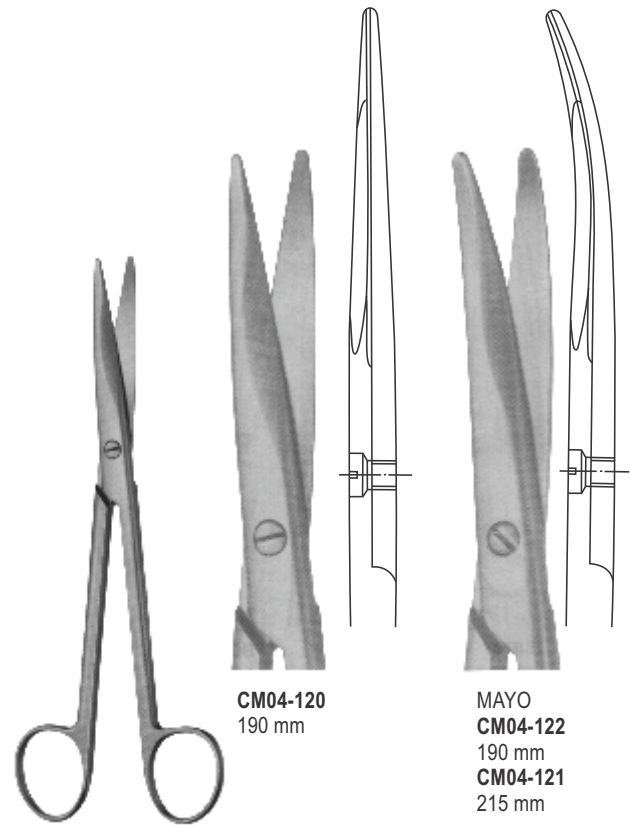

CM04-120
190 mm

MAYO
CM04-122
190 mm
CM04-121
215 mm

CM04-116 - CM04-117
MAYO-STILLE
With chamfered blades
CM04-116 (140 mm)
CM04-117 (170 mm)

MAYO
With chamfered blades
CM04-120 (190 mm)
CM04-121 (215 mm)

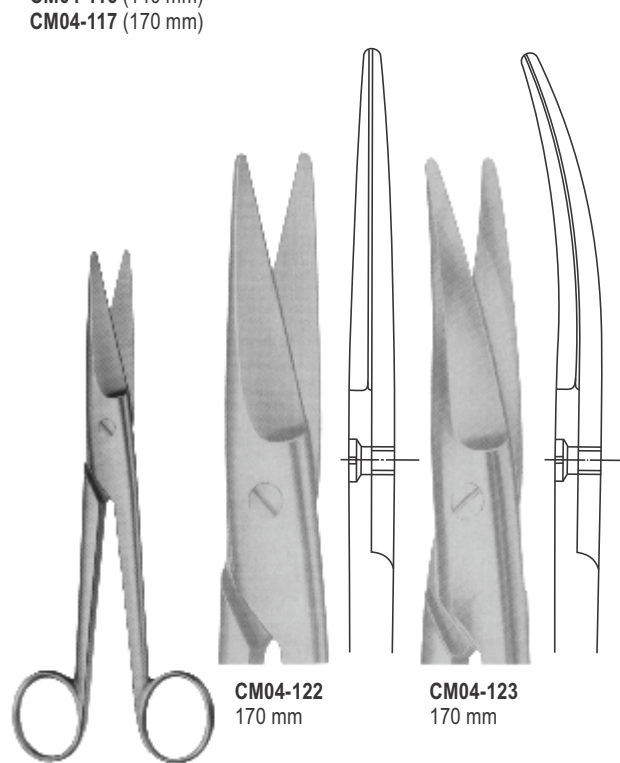

CM04-122
170 mm

CM04-123
170 mm

CM04-122 - CM04-123
MAYO-NOBLE
Broad pattern

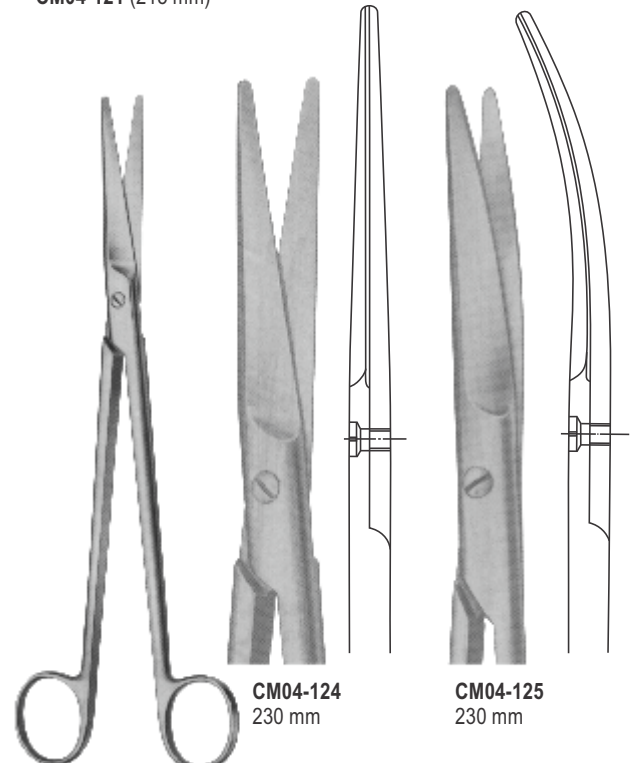

CM04-124
230 mm

CM04-125
230 mm

CM04-124 - CM04-125
MAYO-HARRINGTON

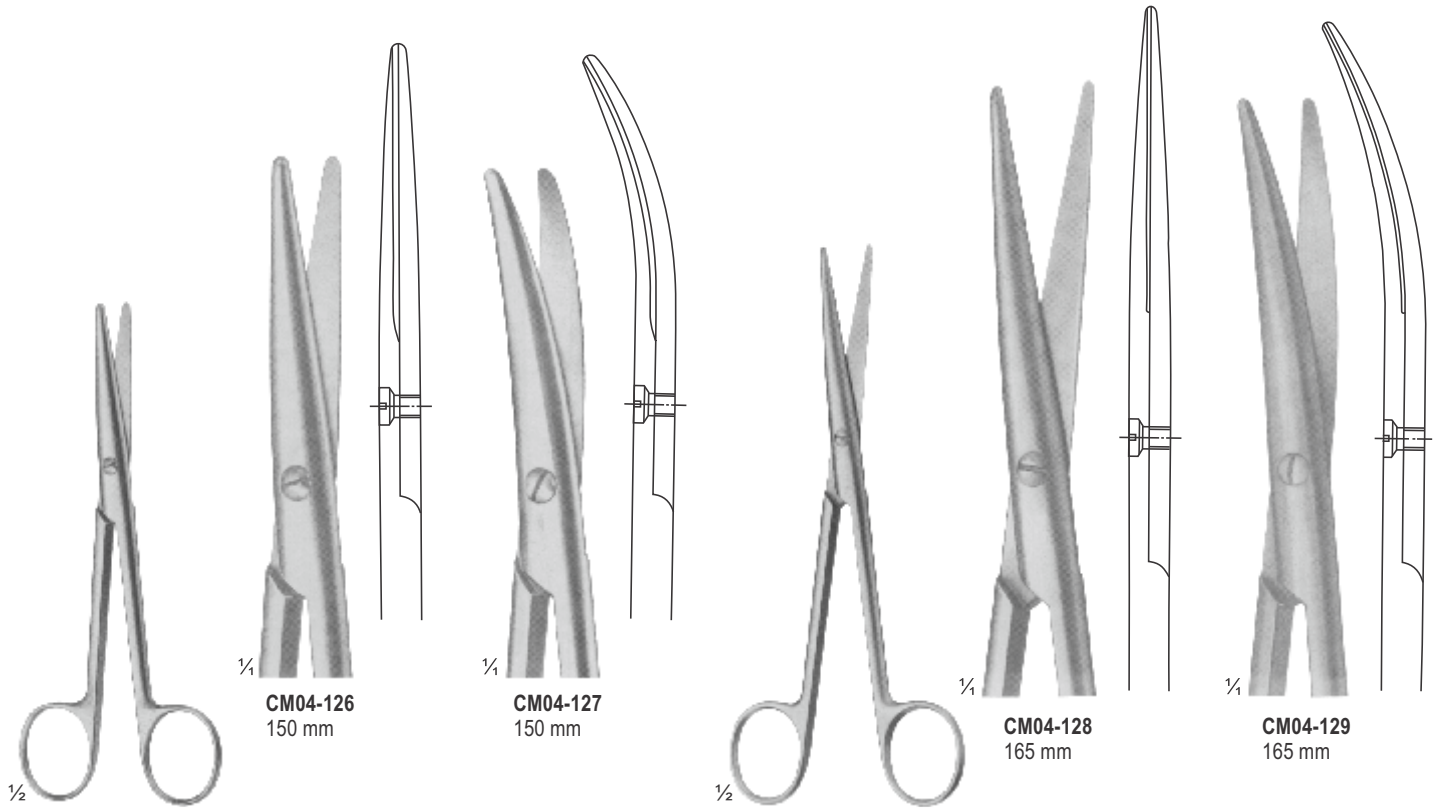

CM04-126
150 mm

CM04-127
150 mm

CM04-128
165 mm

CM04-129
165 mm

CM04-126 - CM04-127
STILLE
150 mm

CM04-128 - CM04-129
LEXER
Narrow
165 mm

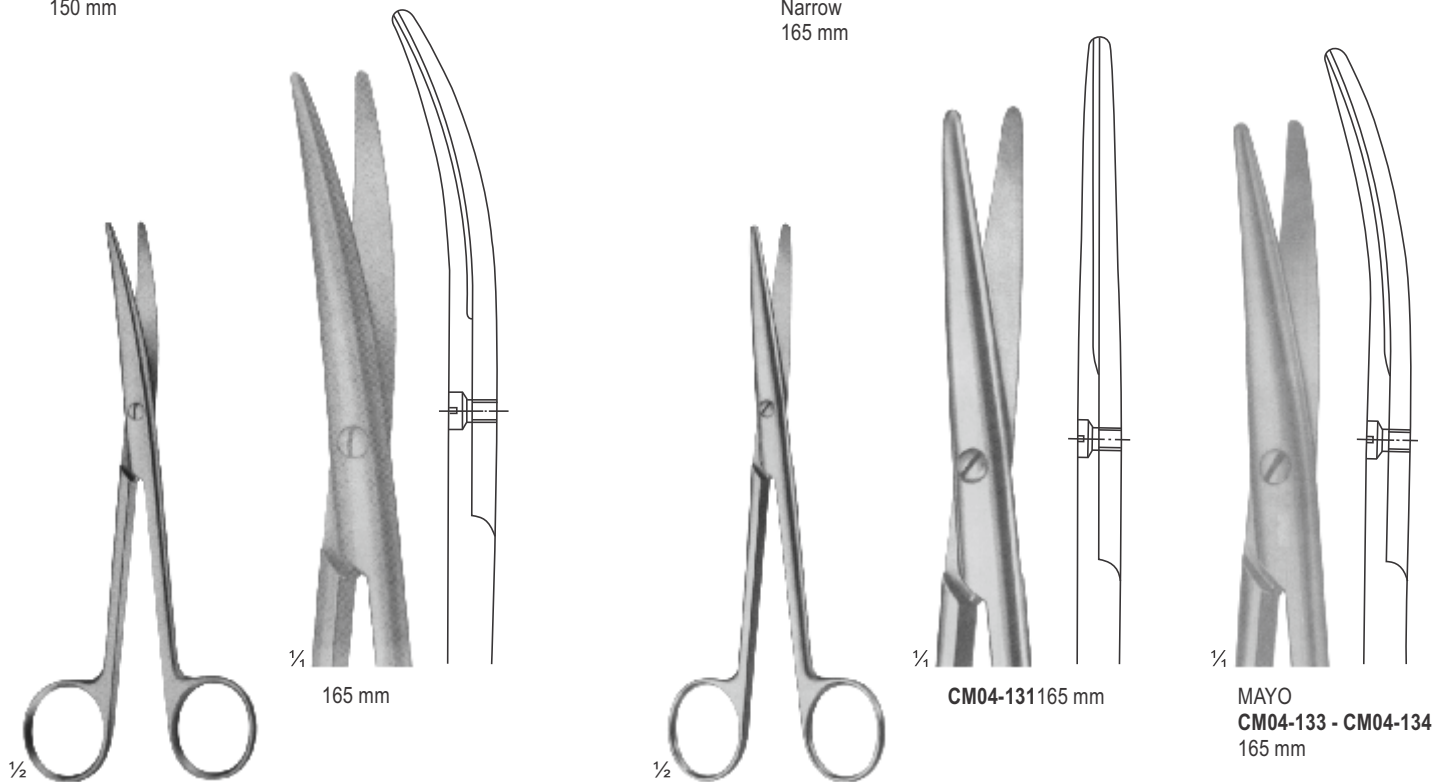

165 mm

CM04-131 165 mm

MAYO
CM04-133 - CM04-134
165 mm

CM04-130
MAYO-LEXER
Standard

CM04-131 - CM04-132
MAYO
CM04-131 (165 mm)
CM04-132 (200 mm)

CM04-133
200 mm
CM04-134
210 mm

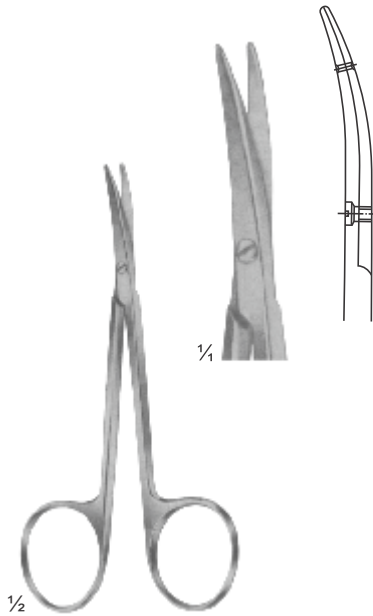

CM04-135
LITTLER
Dissecting Scissors
Tips with eye for suture
115 mm

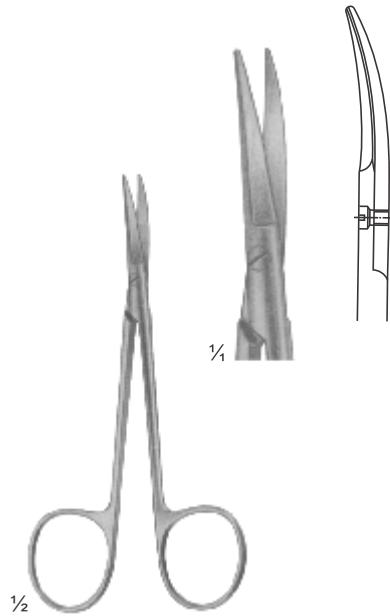

CM04-136
COTTLE
Bulldog Scissors
115 mm

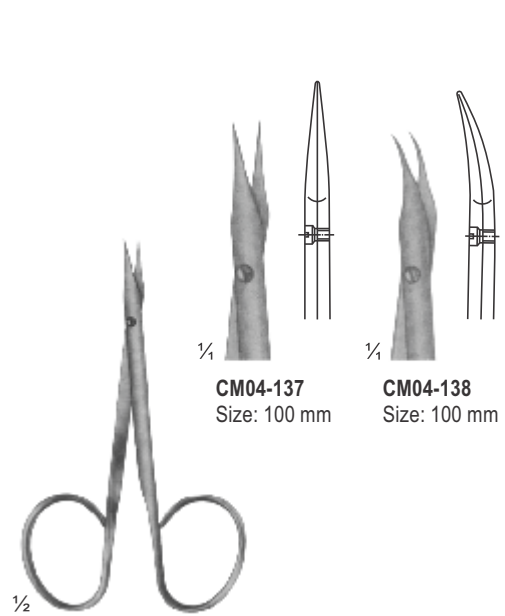

CM04-137 - CM04-138
STEVENS
Vessel and tendon Scissors
100 mm

CM04-137
Size: 100 mm

CM04-138
Size: 100 mm

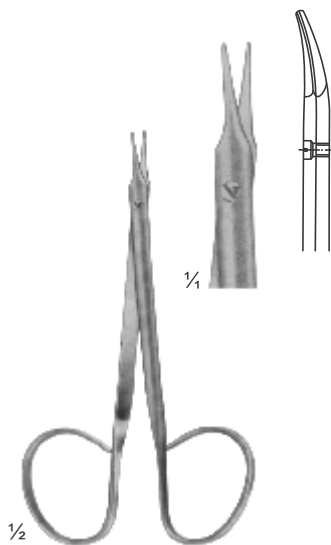

CM04-139
STEVENS
Fine Dissecting Scissors
110 mm

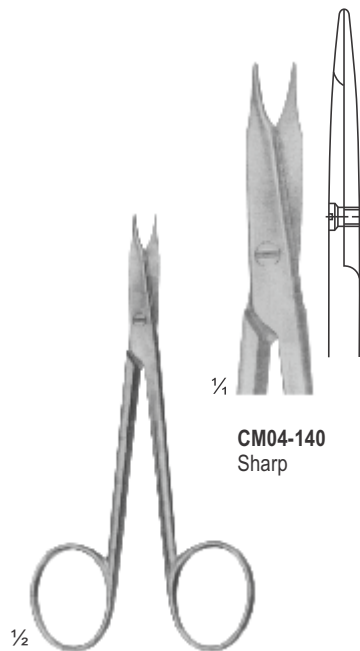

CM04-140 - CM04-143
STEVENS
Vessel and tendon Scissors
110 mm

CM04-140
Sharp

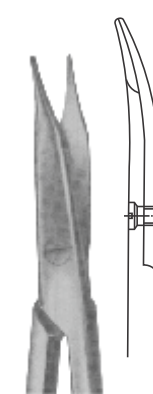

CM04-141
Sharp

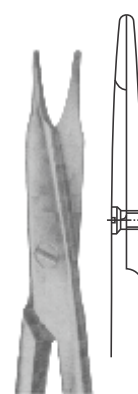

CM04-142
Blunt

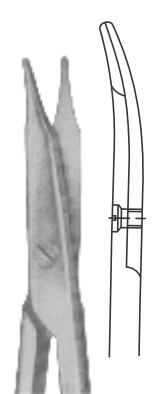

CM04-143
Blunt

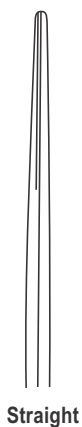

Straight

- FINO-METZENBAUM
CM04-144 - CM04-149
CM04-144 180 mm
CM04-145 200 mm
CM04-146 230 mm
CM04-147 260 mm
CM04-148 280 mm
CM04-149 300 mm

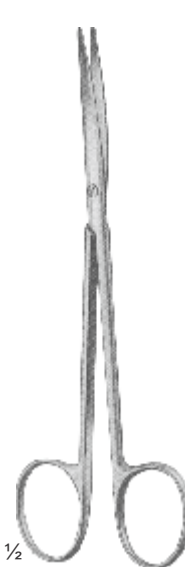

Curved

- FINO-METZENBAUM
CM04-150 - CM04-155
CM04-151 180 mm
CM04-152 200 mm
CM04-153 230 mm
CM04-154 260 mm
CM04-154 280 mm
CM04-155 300 mm

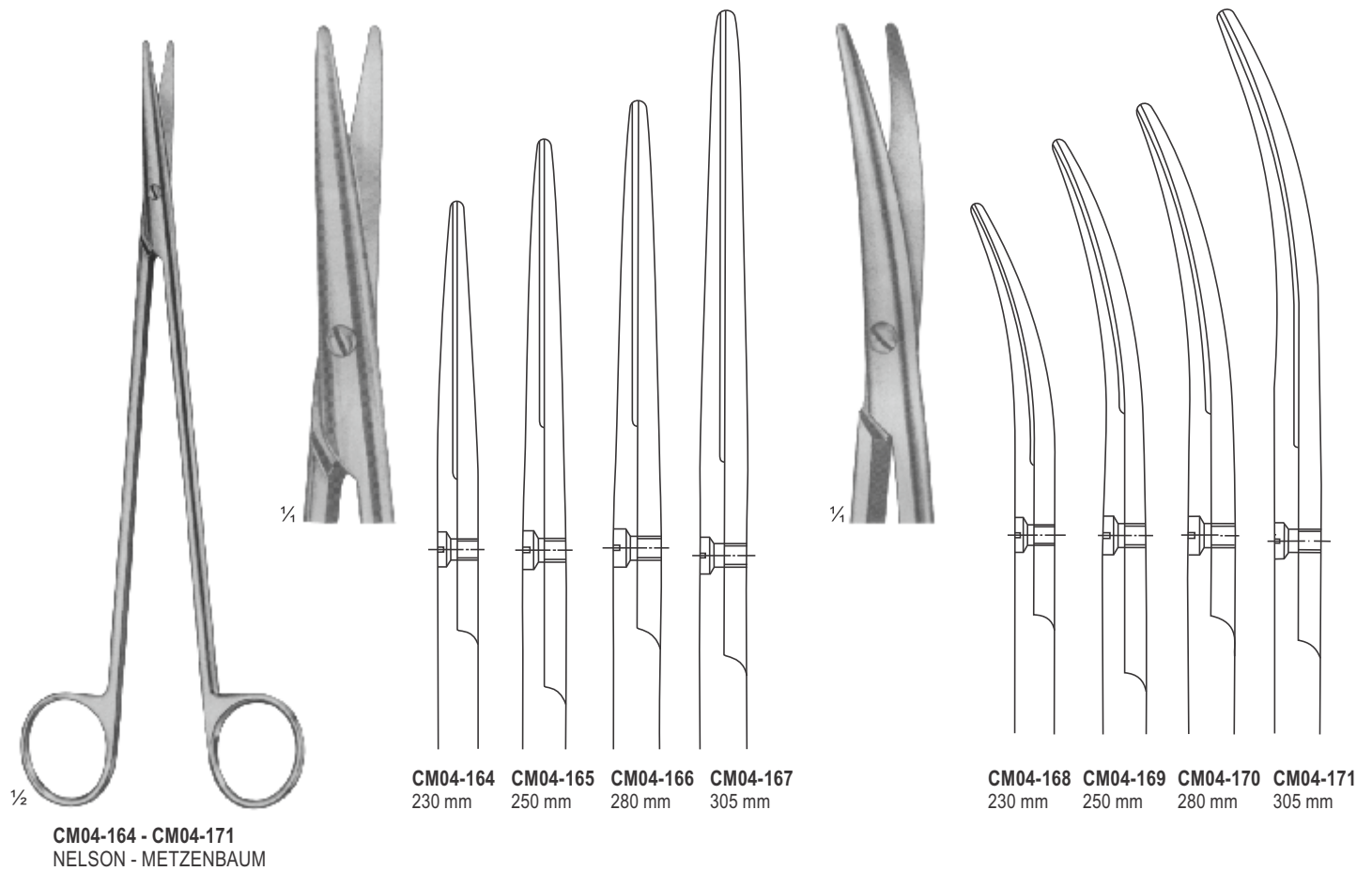
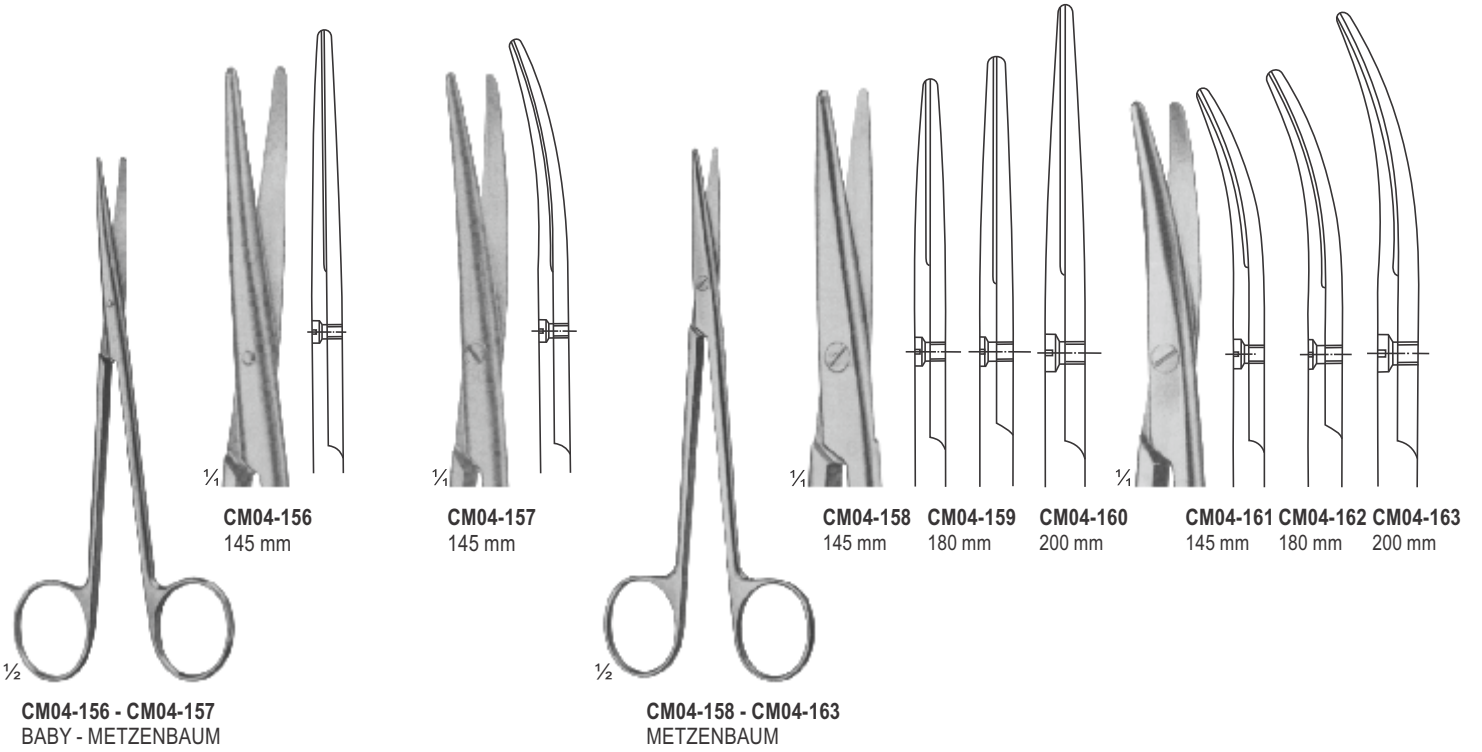



CM04-172 - CM04-174
Fine Operating Scissors
120 mm

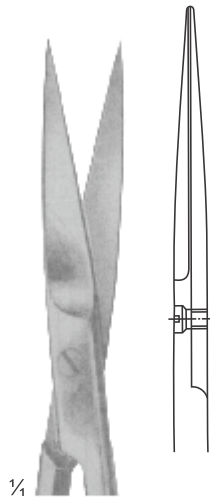

CM04-172

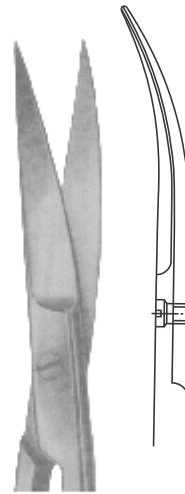

CM04-173

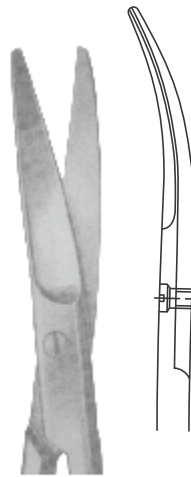

CM04-174



CM04-175 - CM04-178
Fine Operating Scissors
130 mm

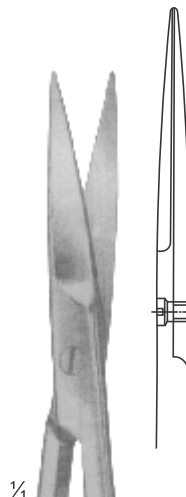

CM04-175

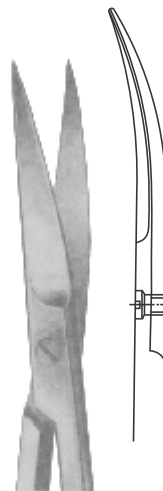

CM04-176

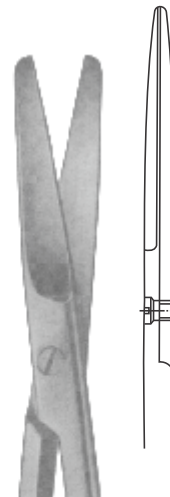

CM04-177

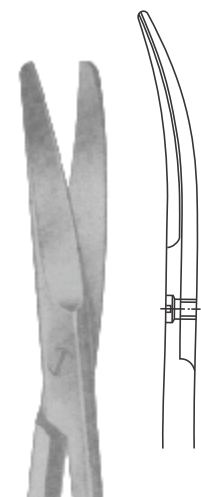

CM04-178

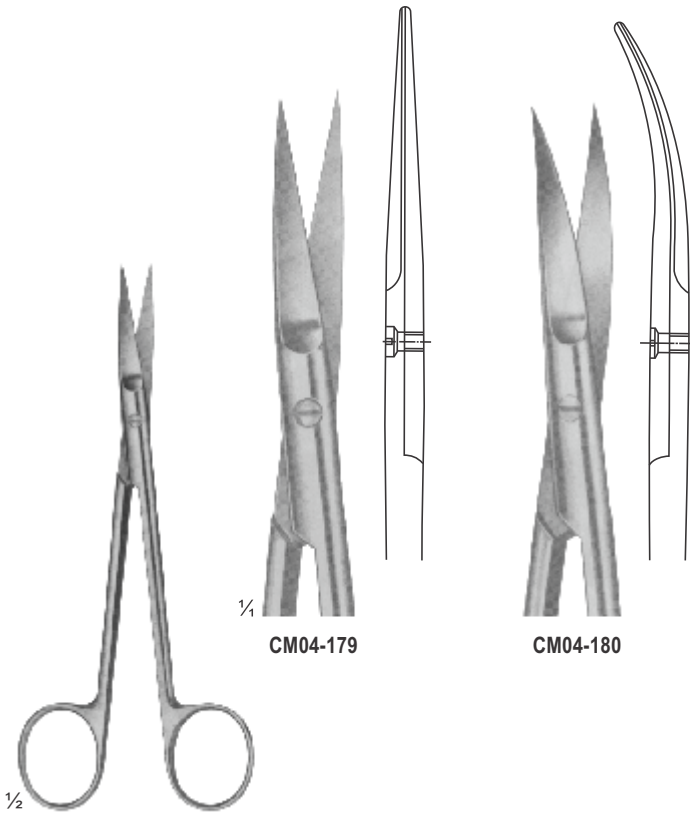

CM04-179

CM04-180

CM04-179 - CM04-180
JOSEPH
150 mm

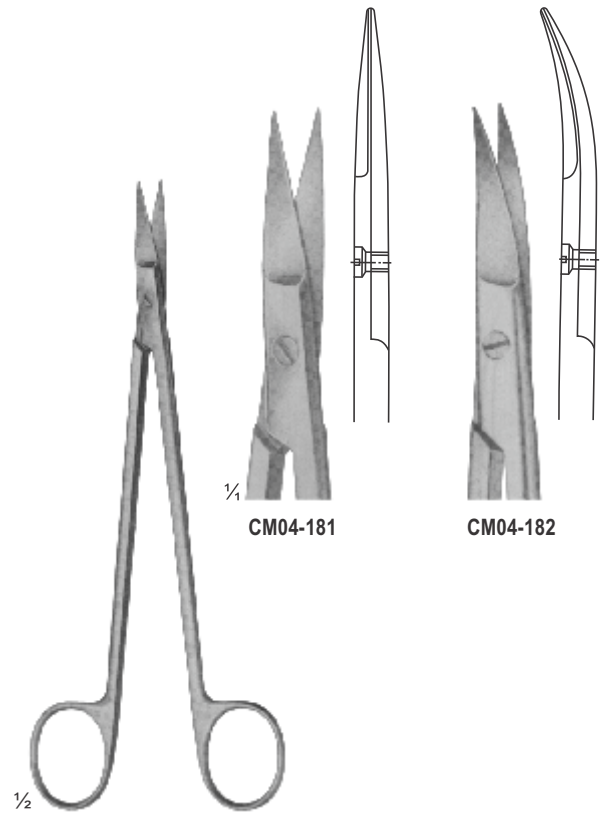

CM04-181

CM04-182

CM04-181 - CM04-182
KELLY
175 mm

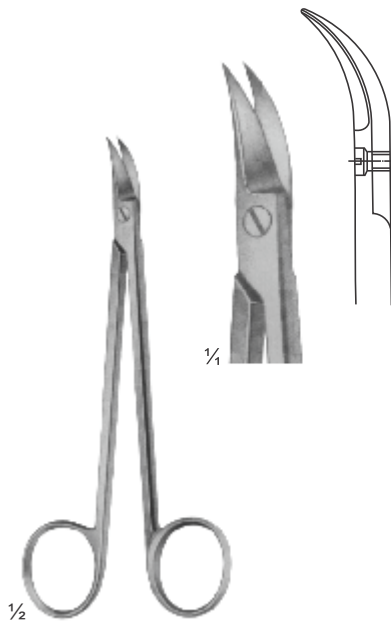

CM04-183
QUINBY
130 mm

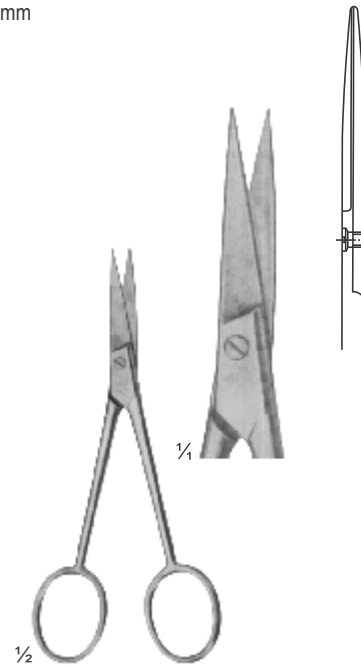

CM04-184
Dissecting
110 mm

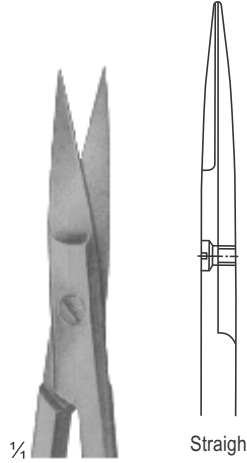

¼

Straigh

KELLY
CM04-185
17.5 cm

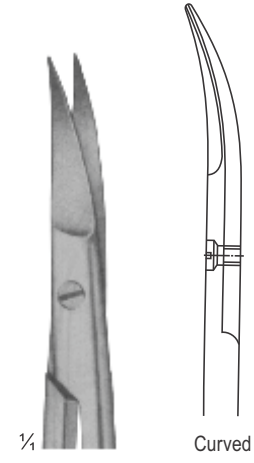

¼

Curved

½

KELLY
CM04-186
17.5 cm

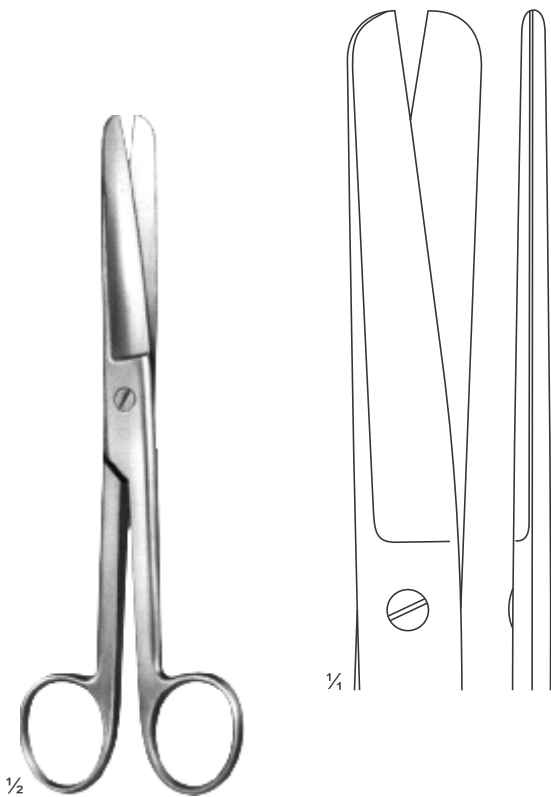

¼

½

DOYEN
CM04-187
18.5 cm

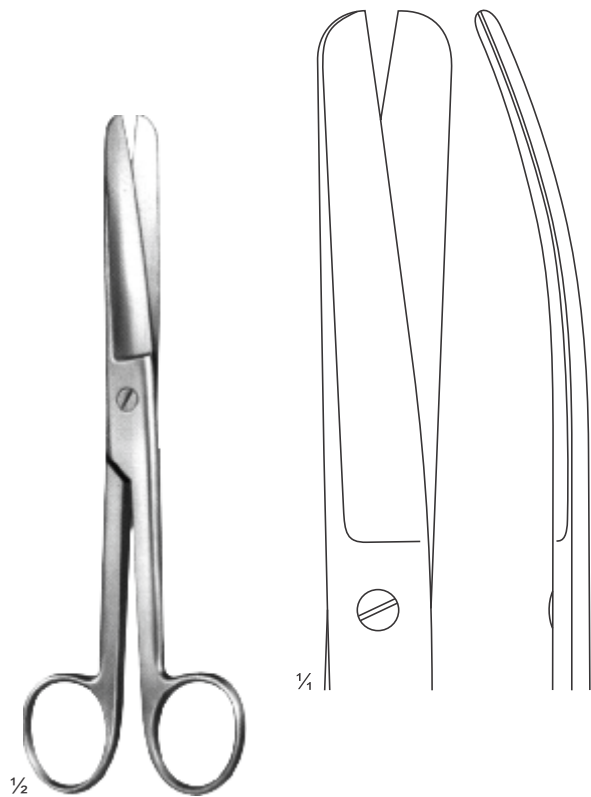

¼

½

DOYEN
CM04-188
18.5 cm

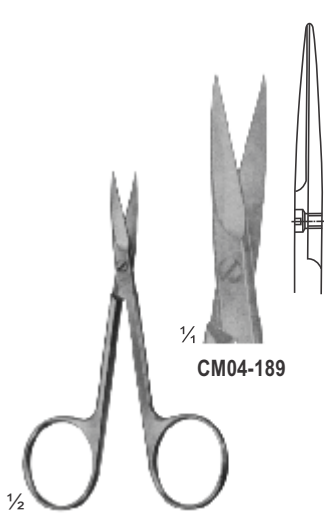

CM04-189

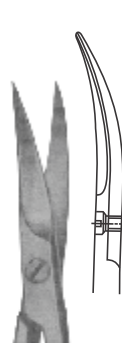

CM04-190

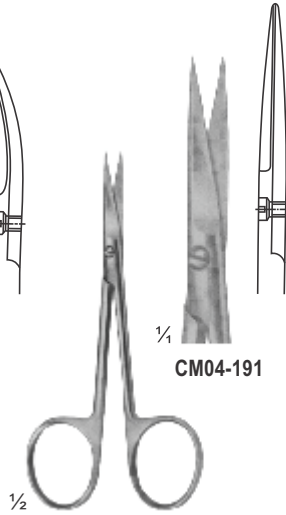

CM04-191

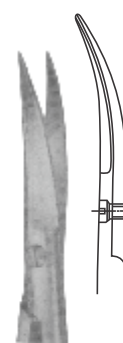

CM04-192

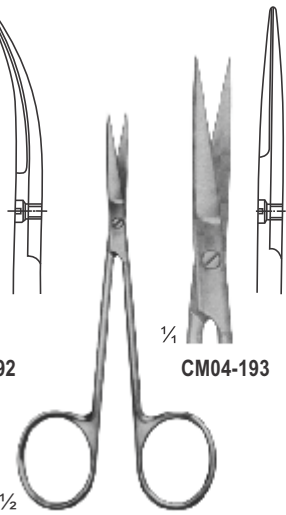

CM04-193

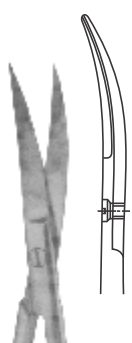

CM04-194

CM04-189 - CM04-190
Cutical
90 mm

CM04-191 - CM04-192
95 mm

CM04-193 - CM04-194
Iris
100 mm

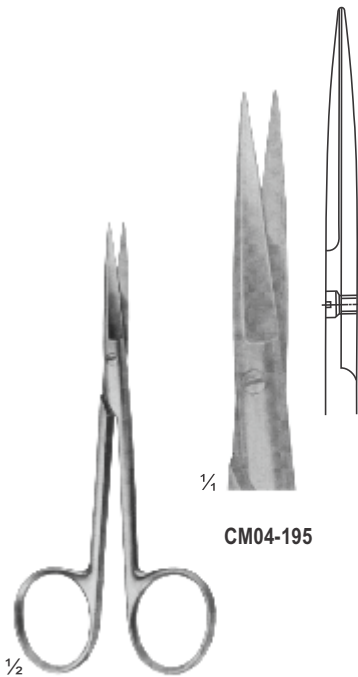

CM04-195

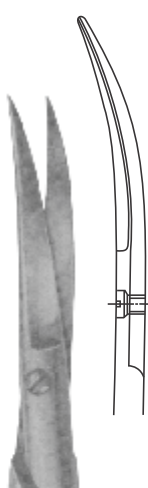

CM04-196

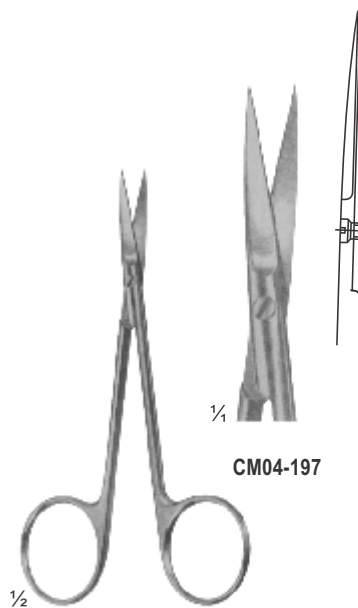

CM04-197

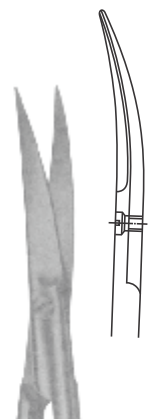

CM04-198

CM04-195 - 065
Wagner
130 mm

CM04-197 - CM04-198
Iris
110 mm

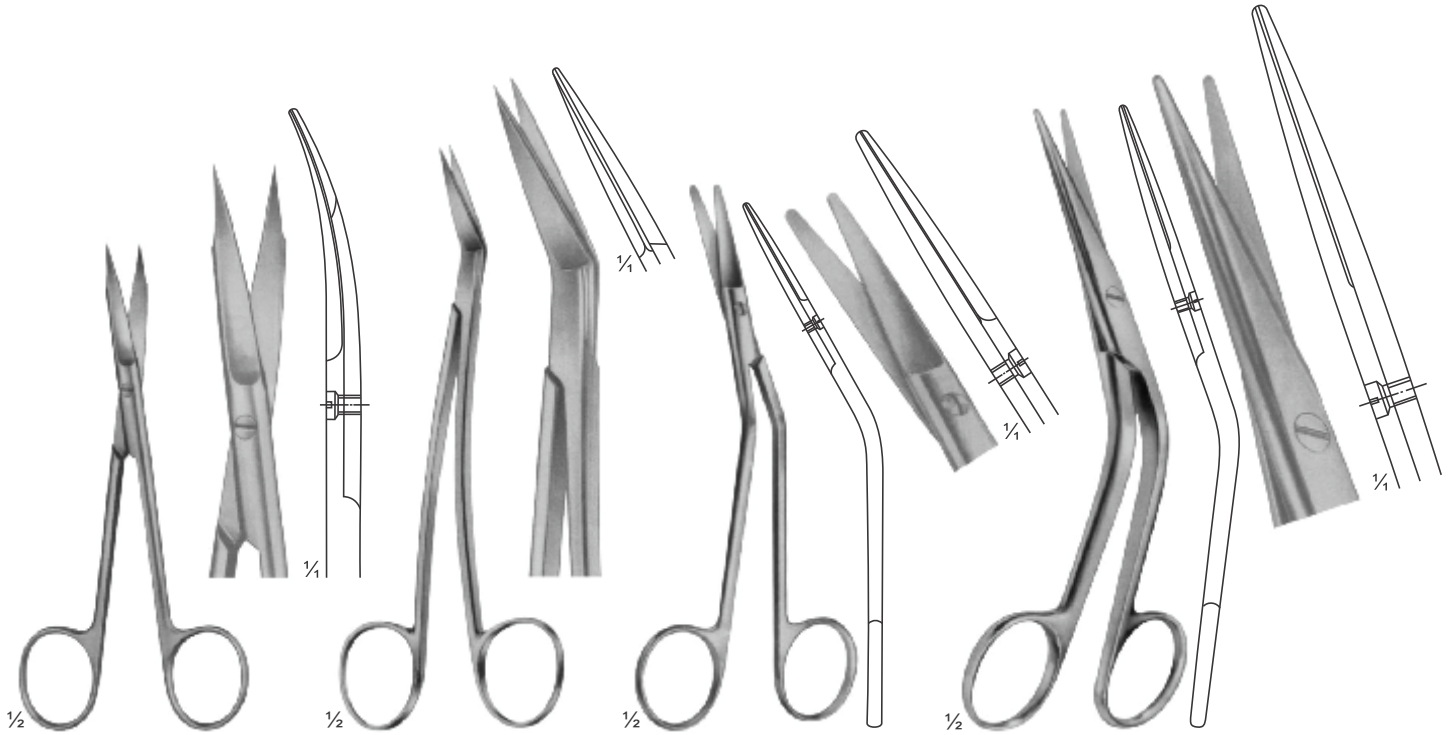

GOLDMAN-FOX
CM04-199
One Toothed Cutting Edge
13 cm

LOCKLIN
CM04-200
Curved Sideways,
1 Toothed Blade
15.5 cm

FOMON
CM04-201
Blades Serrated
14.5 cm

COTTLE
CM04-202
16.5 cm

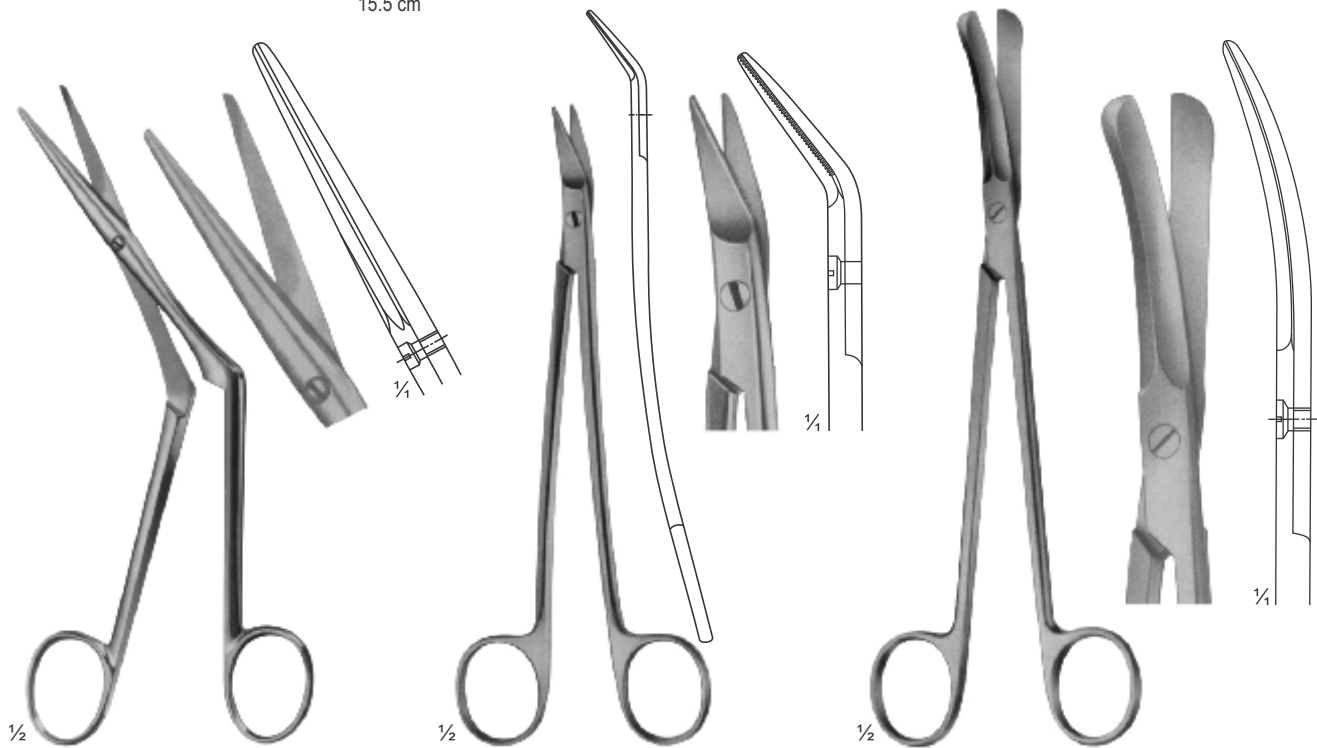

HEYMANN-KNIGHT
CM04-203
17.5 cm

DEAN
CM04-204
Blades Serrated
17 cm

GOOD
CM04-205
19.5 cm

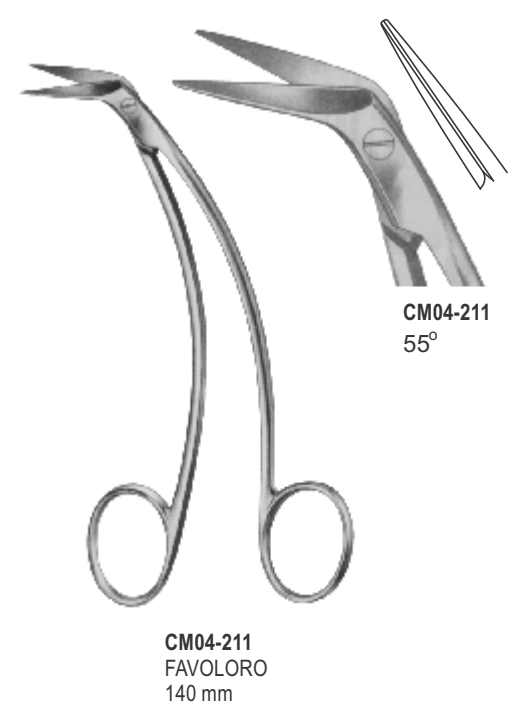
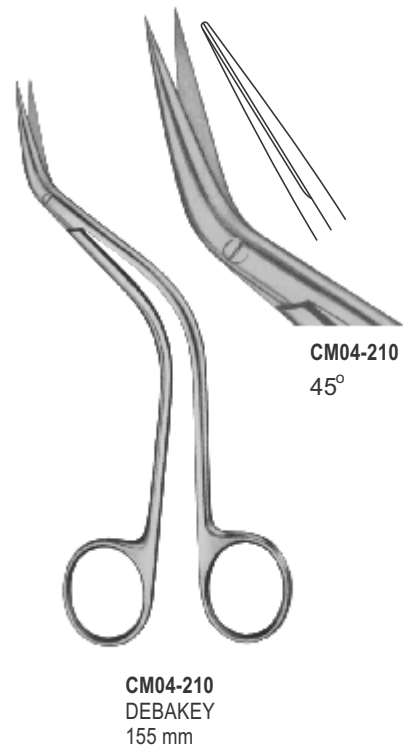
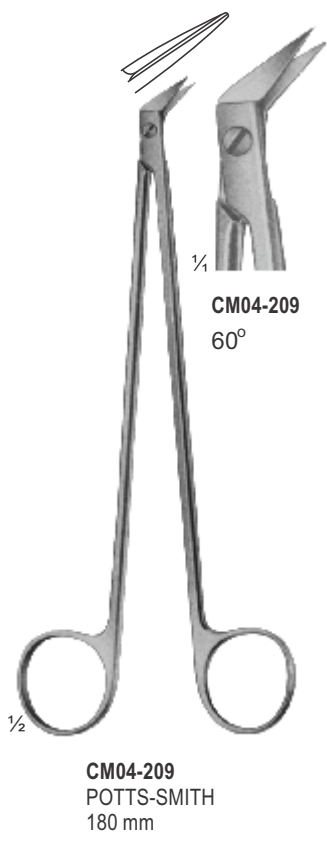
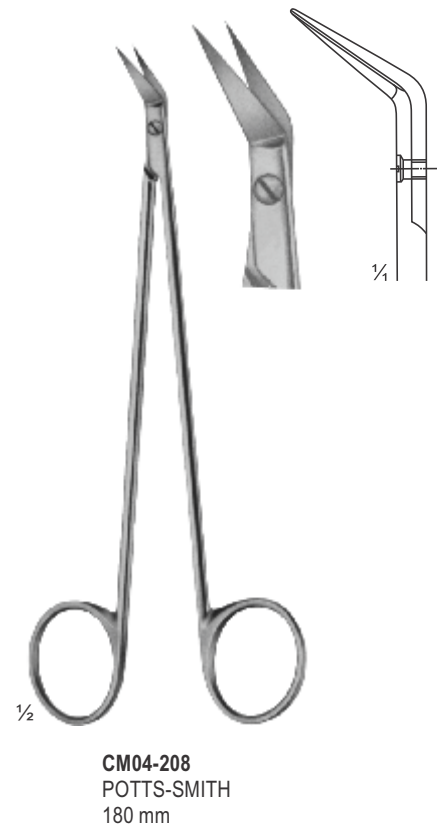
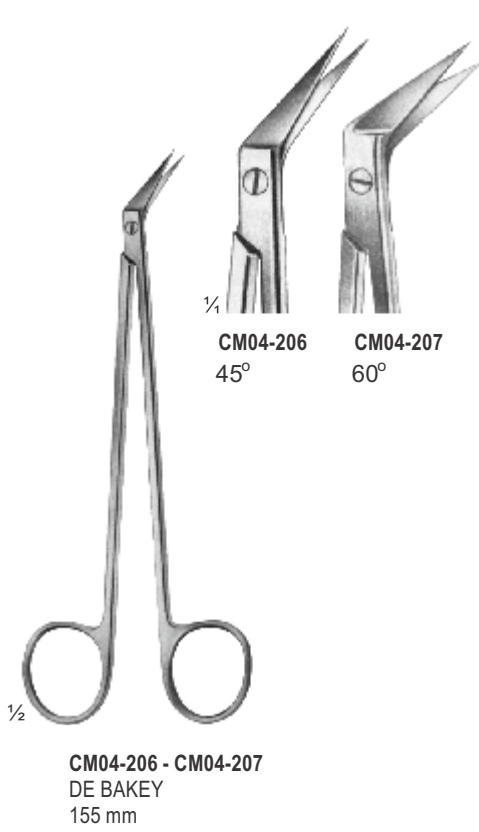

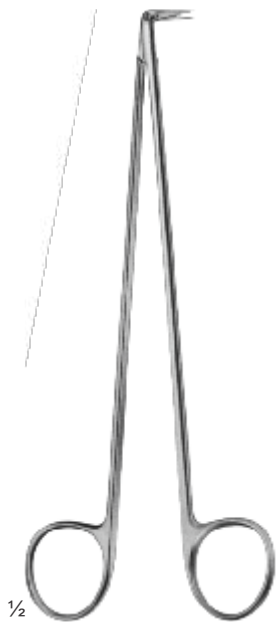

CM04-212
190 mm
25°



CM04-213
185 mm
45°

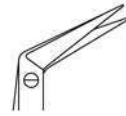

CM04-214
175 mm
60°



CM04-215
175 mm
90°

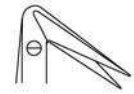

CM04-216
175 mm
120°

DIETRICH
CM04-212 - CM04-216



CM04-217
185 mm
25°



CM04-218
185 mm
45°

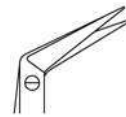

CM04-219
185 mm
60°

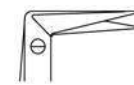

CM04-220
185 mm
90°

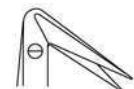

CM04-221
185 mm
120°

MIKRO-HEGEMANN
CM04-217 - CM04-221
185 mm

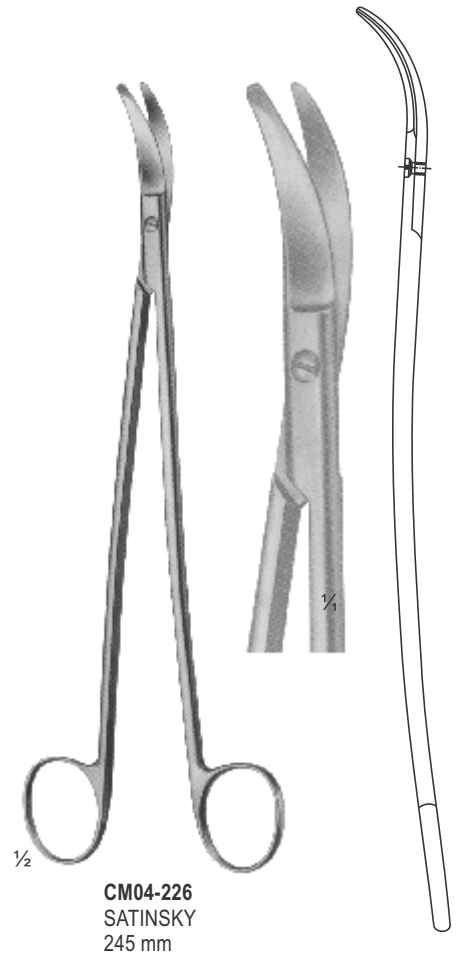
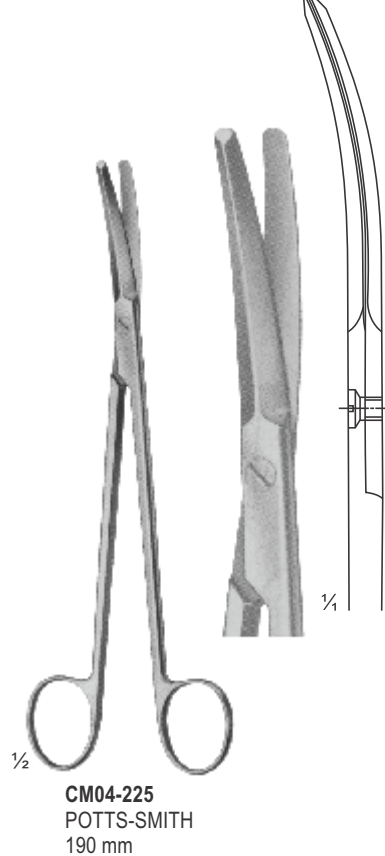
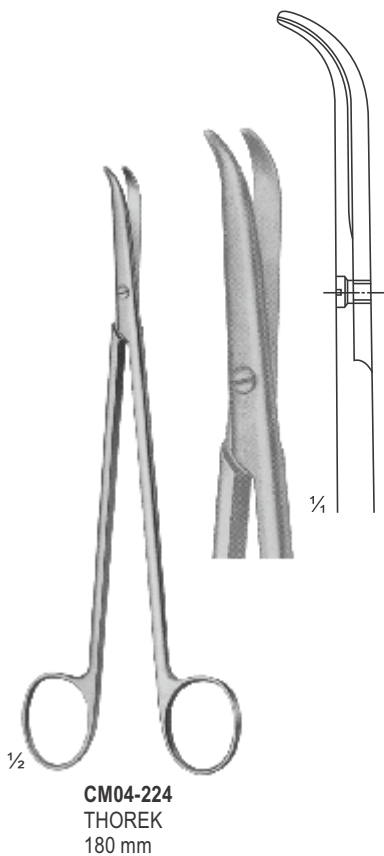
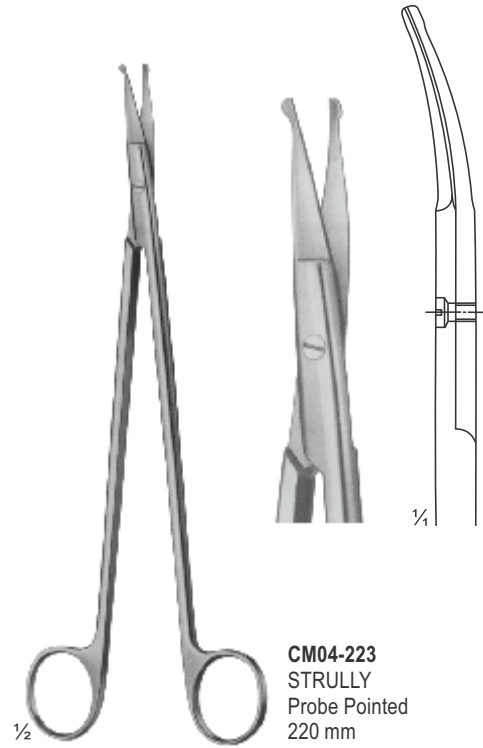
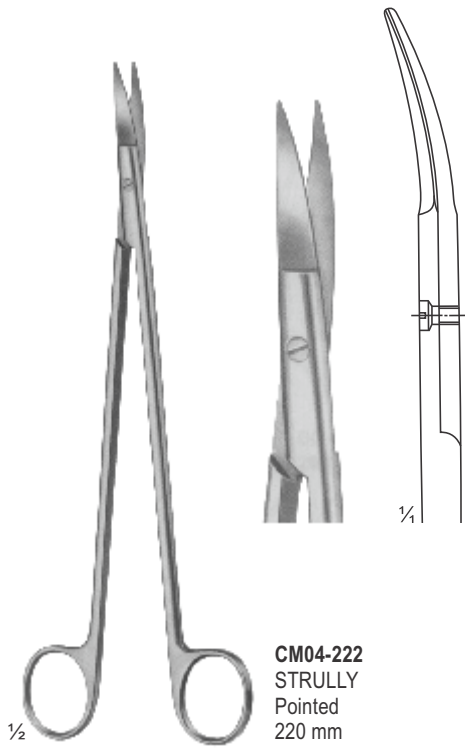



CM04-227
UNIVERSAL AND BANDAGE SCISSORS
180 mm

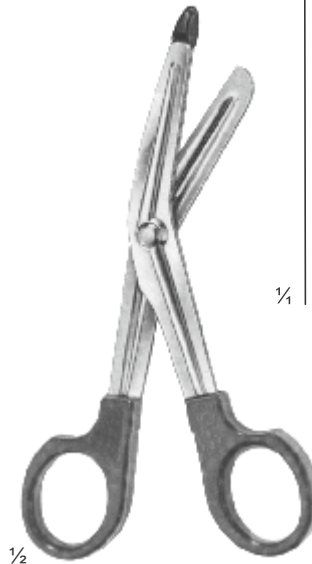
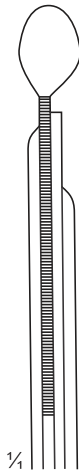

CM04-228
LISTER
145 mm

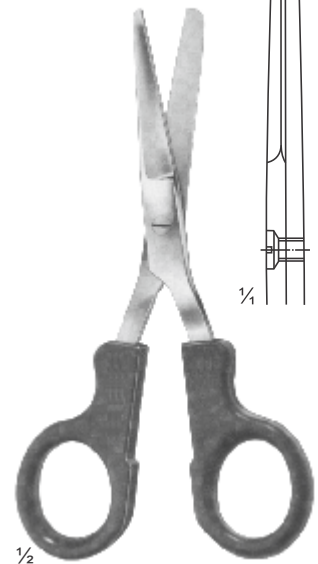
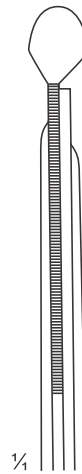

CM04-229
LISTER
145 mm

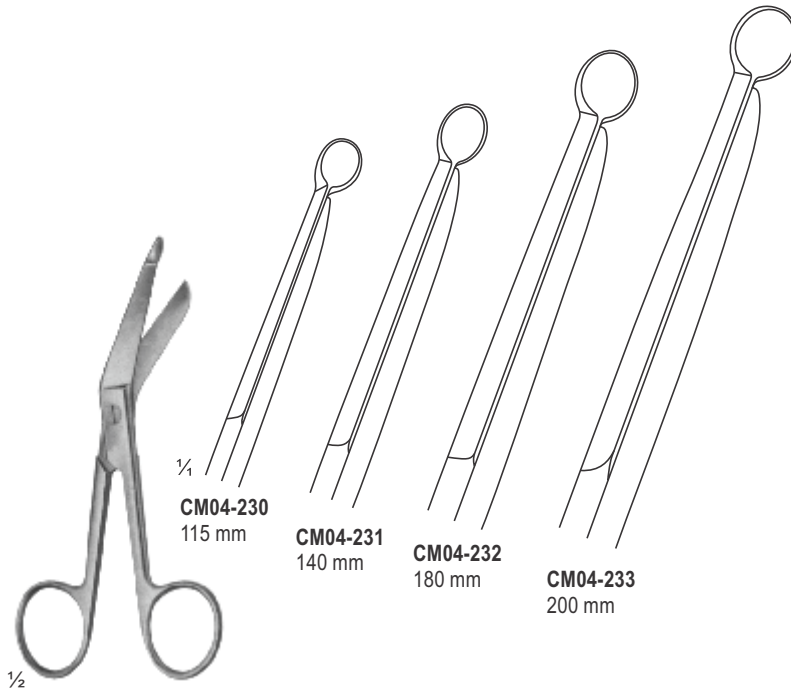

CM04-230 - CM04-233
LISTER

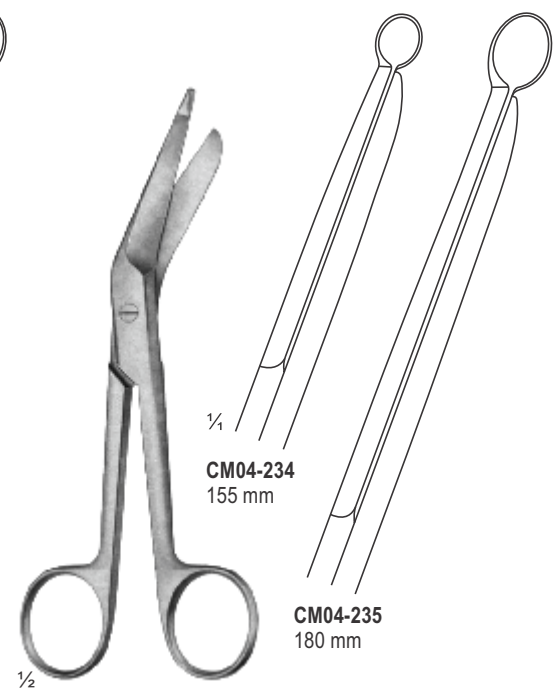

CM04-234 - CM04-235
LISTER



CM04-236
CLOTH SCISSORS
205 mm

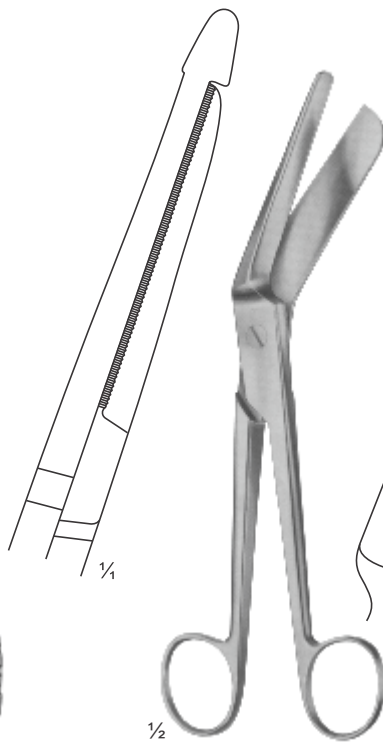

CM04-237
BRAUN-STADLER
225 mm

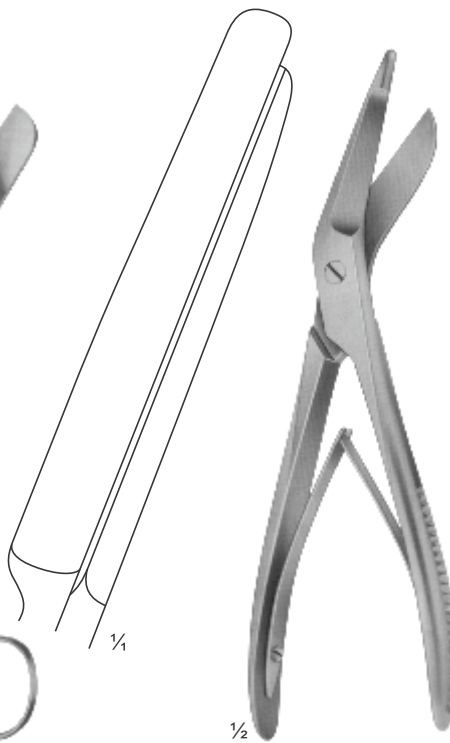

CM04-238
SEUTIN
230 mm

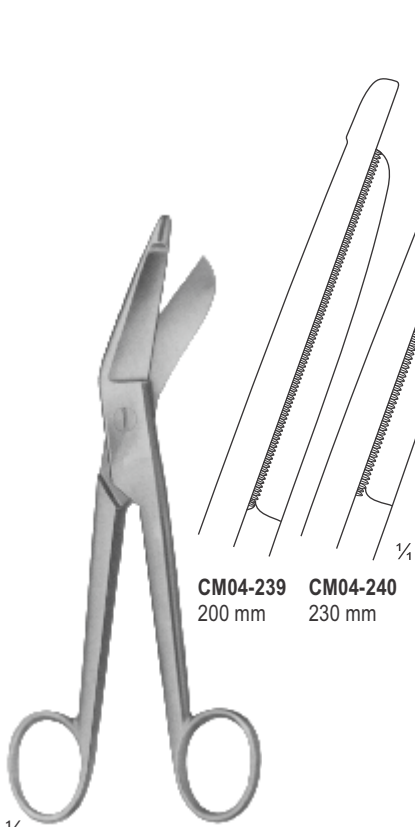

CM04-239 - CM04-240
ESMARCH

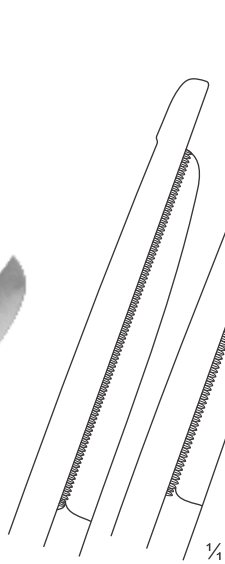

CM04-239
200 mm

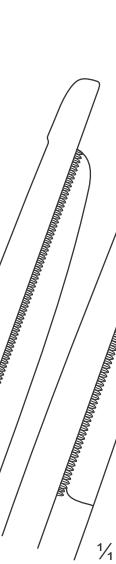

CM04-240
230 mm



CM04-241
BRUNS
235 mm

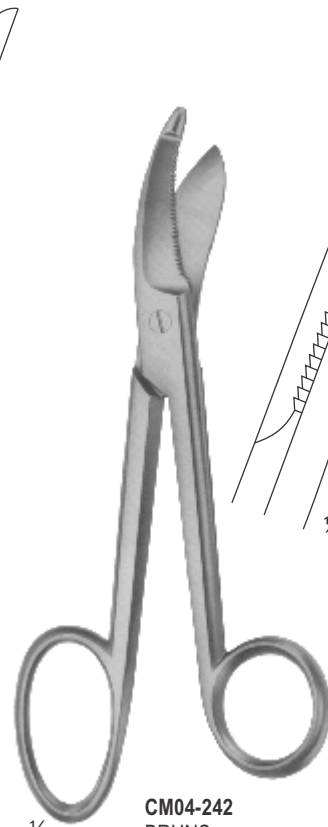

CM04-242
BRUNS
235 mm

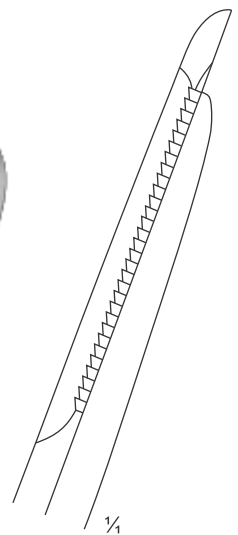

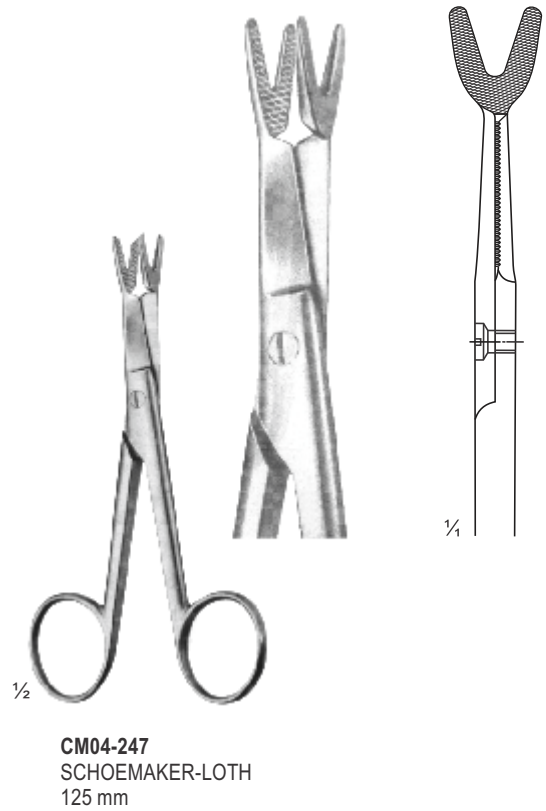
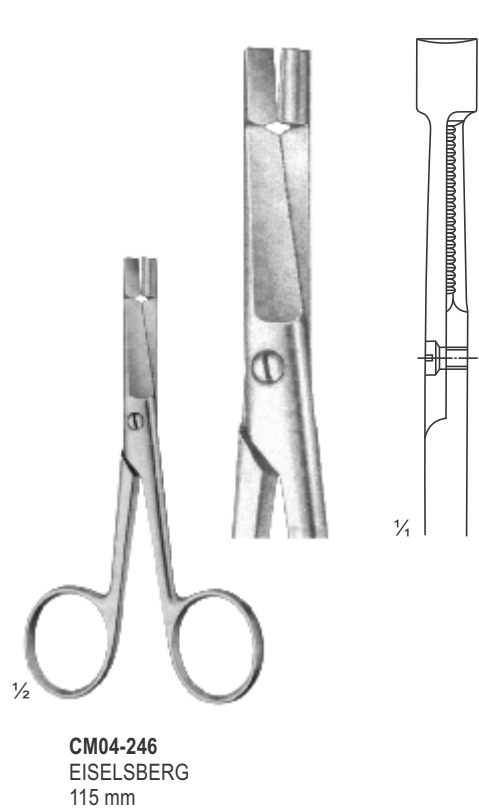
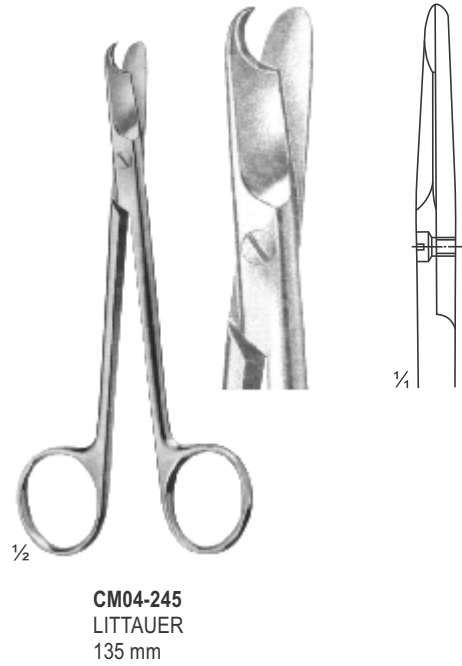



1/2

CM04-258 - CM04-252
BEEBE
110 mm

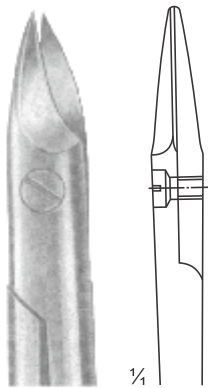

1/4

CM04-248

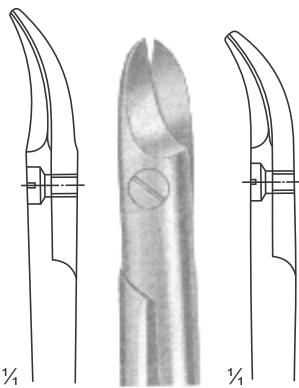

1/4

CM04-249
Broad Blades

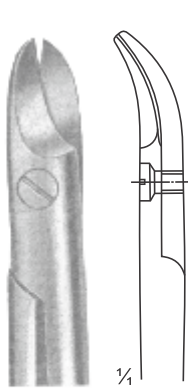

1/4

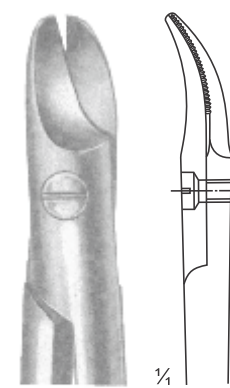

1/4

CM04-251
1 Blade Serrated

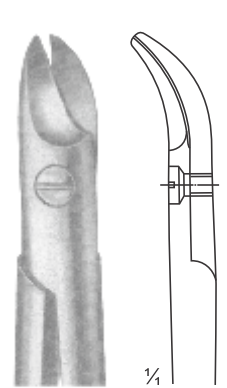

1/4

CM04-252
NAUJOKS
Strongly Curved

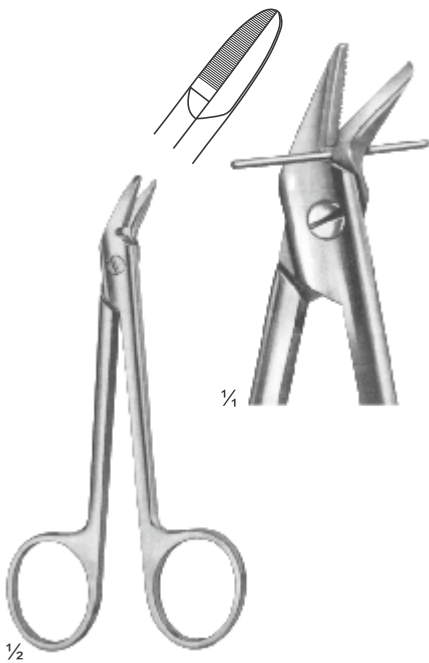

1/2

CM04-253
1 Blade Serrated
120 mm

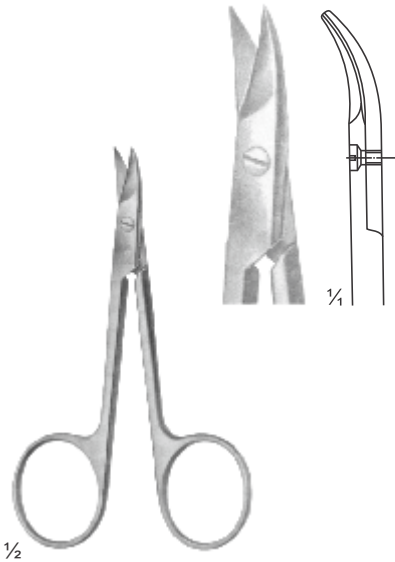

1/2

CM04-254
STRACK
100 mm

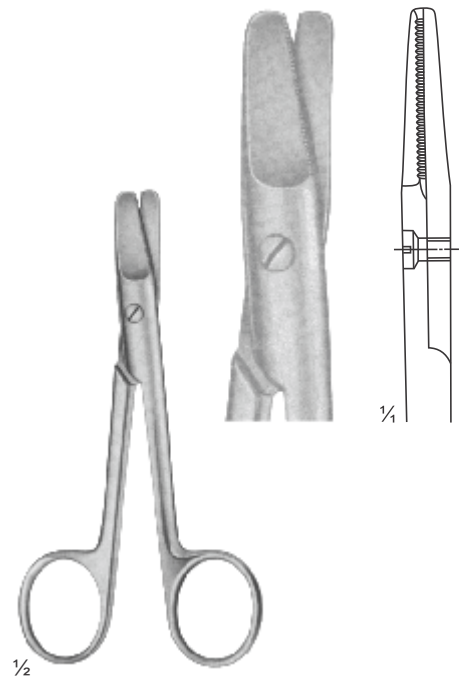

1/2

CM04-255
HARVEY
125 mm

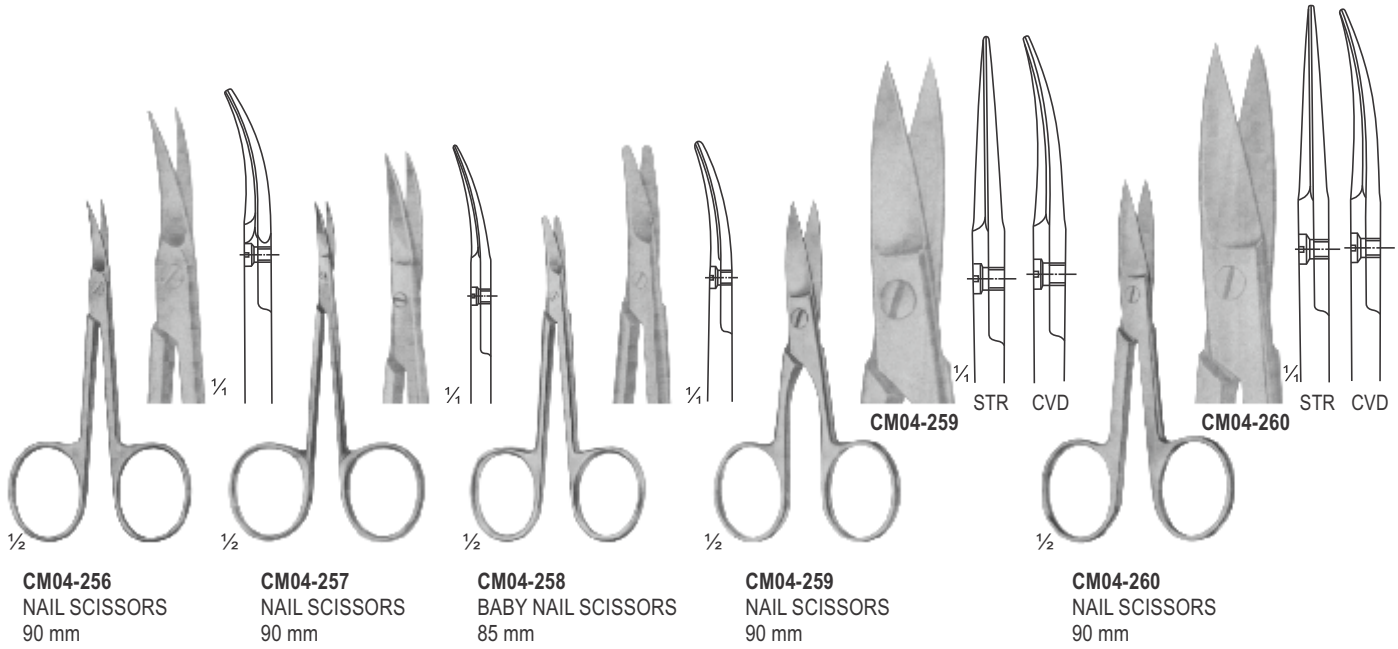

CM04-256
NAIL SCISSORS
90 mm

CM04-257
NAIL SCISSORS
90 mm

CM04-258
BABY NAIL SCISSORS
85 mm

CM04-259
NAIL SCISSORS
90 mm

CM04-260
NAIL SCISSORS
90 mm

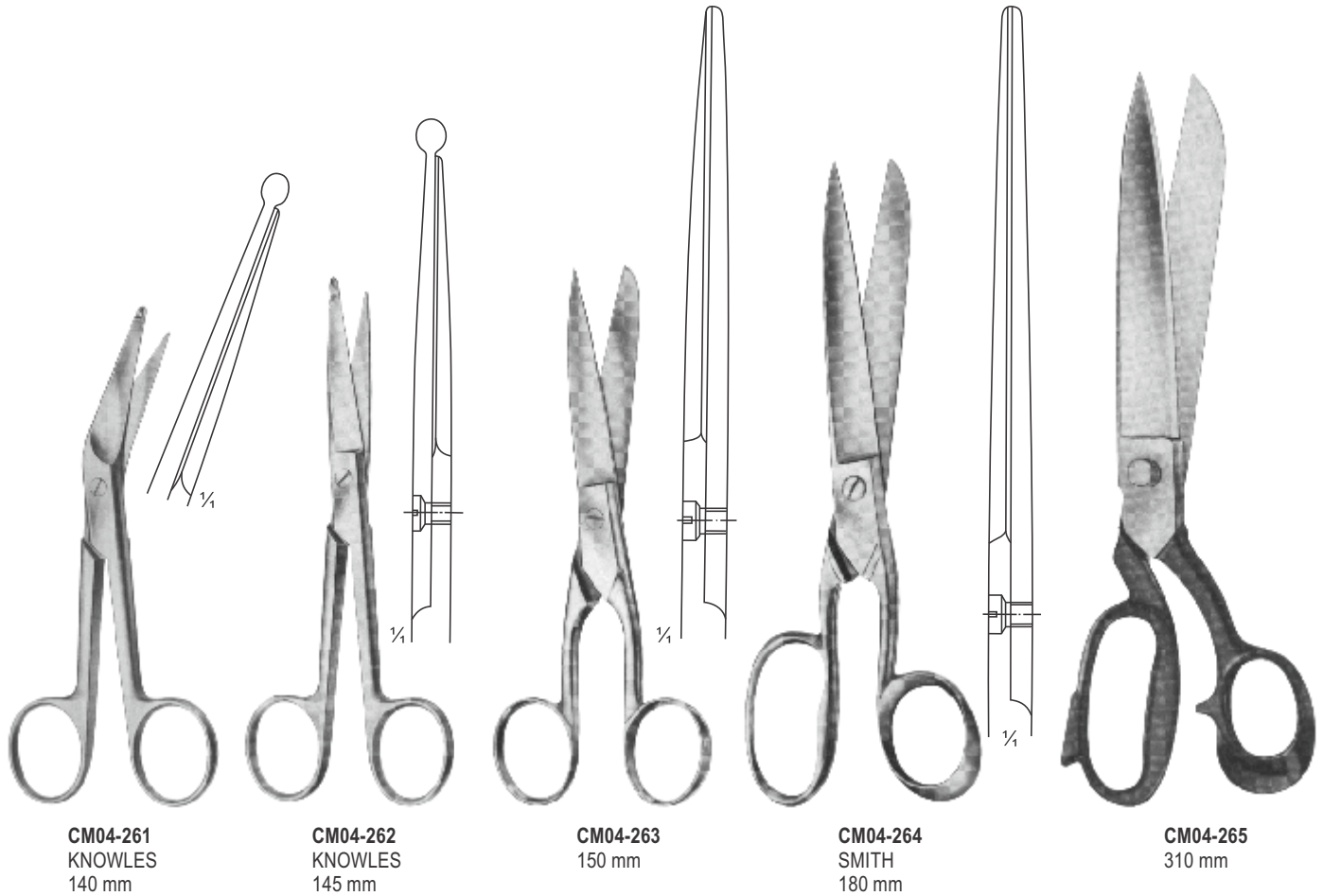

CM04-261
KNOWLES
140 mm

CM04-262
KNOWLES
145 mm

CM04-263
150 mm

CM04-264
SMITH
180 mm

CM04-265
310 mm

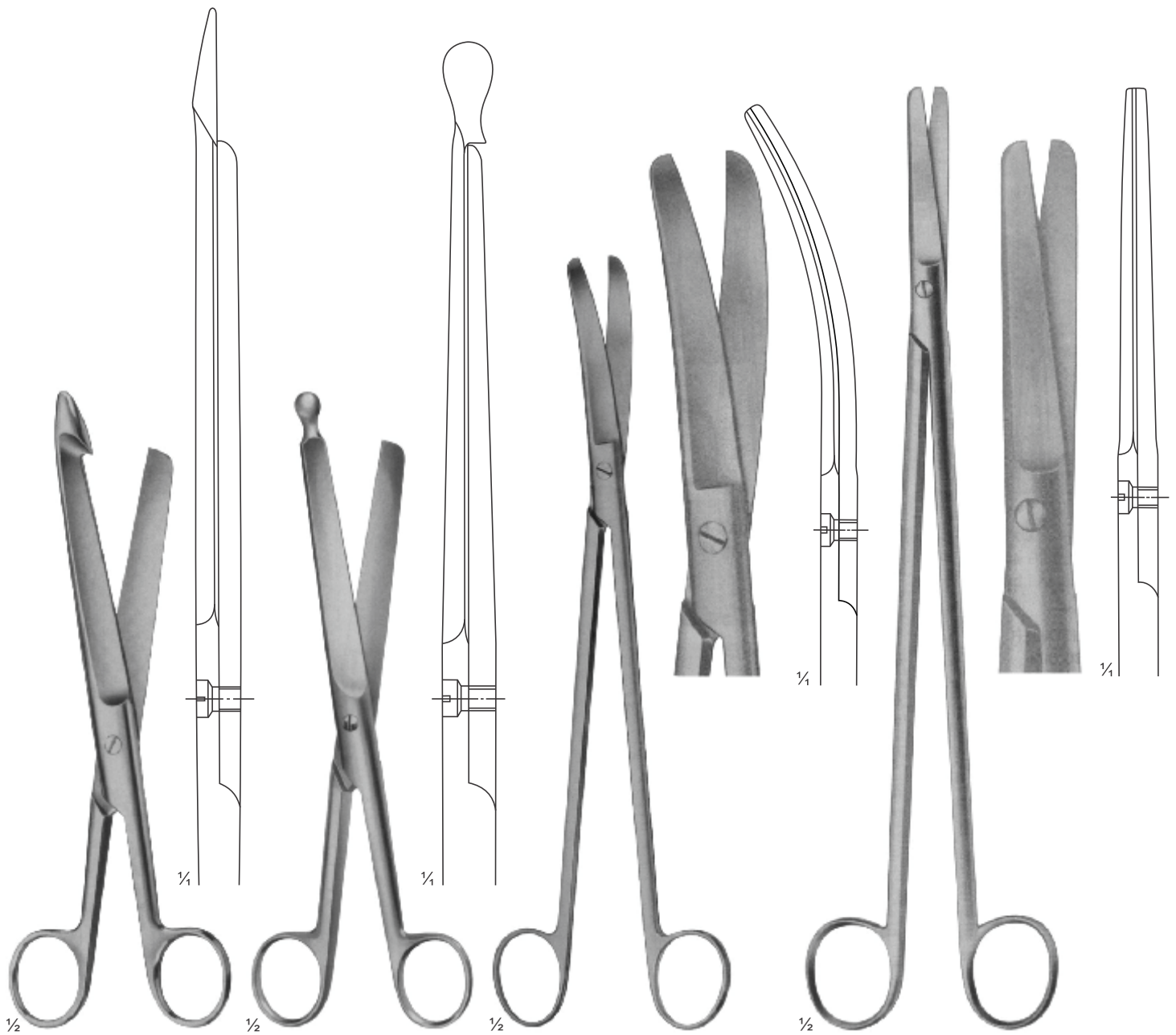

DAMMSCHERE
CM04-266
Bowel Scissors
21 cm

DAMMSCHERE
CM04-267
Bowel Scissors
21 cm

LLOYD-DAVIES
(GOLIGHER'S)
CM04-268
Rectal Scissors
25.5 cm

STELZNER
CM04-269
Rectal Scissors
31 cm

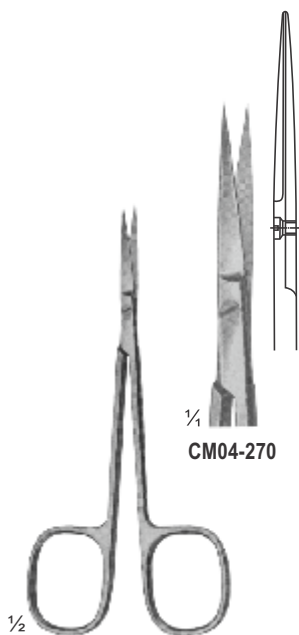

1/4
CM04-270

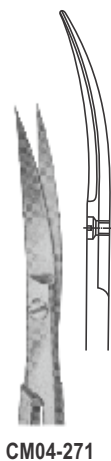

CM04-271

CM04-270 - CM04-271
120 mm

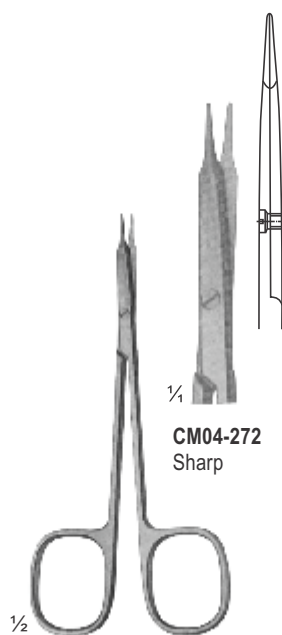

1/4
CM04-272
Sharp

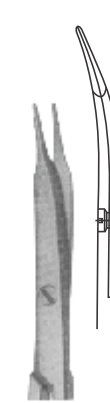

CM04-273
Sharp

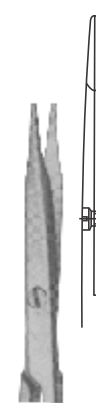

CM04-274
Blunt



CM04-275
Blunt

CM04-272 - CM04-2705
STEVENS
Dissecting Scissors
115 mm

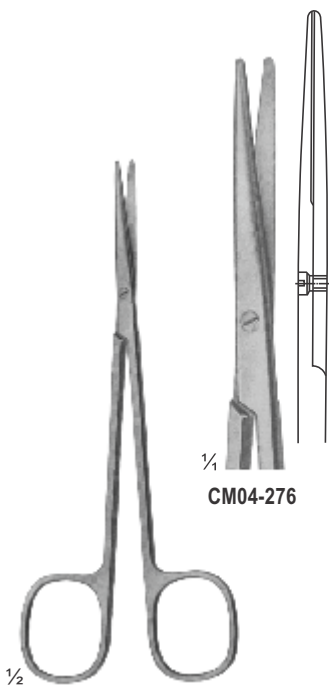

1/4
CM04-276

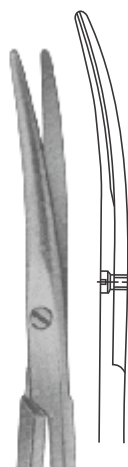

CM04-277

CM04-276 - CM04-277
METZENBAUM
Dissecting Scissors
145 mm

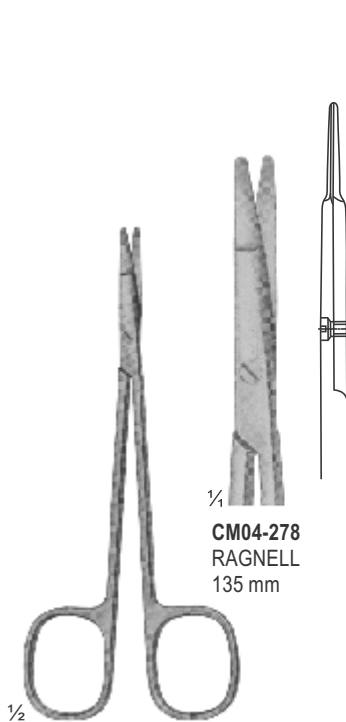

1/4
CM04-278
RAGNELL
135 mm

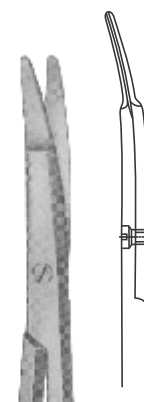

CM04-280
RAGNELL
135 mm

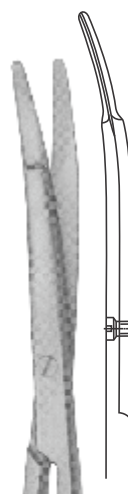

CM04-281
150 mm

CM04-278 - CM04-281
Special flat points for
dissecting and
undermining the skin
145 mm



STANDARD OPERATING SCISSOR
CM04-282 11.5 cm, 4 1/2"
CM04-283 13.0 cm, 5"
CM04-284 14.5 cm, 5 3/4"
CM04-285 16.5 cm, 6 1/2"
CM04-286 18.5 cm, 7 1/4"
CM04-287 20.0 cm, 8"



STANDARD OPERATING SCISSOR
CM04-288 11.5 cm, 4 1/2"
CM04-289 13.0 cm, 5"
CM04-290 14.5 cm, 5 3/4"
CM04-291 16.5 cm, 6 1/2"
CM04-292 18.5 cm, 7 1/4"
CM04-293 20.0 cm, 8"



STANDARD OPERATING SCISSOR
CM04-294 11.5 cm, 4 1/2"
CM04-295 13.0 cm, 5"
CM04-296 14.5 cm, 5 3/4"
CM04-297 16.5 cm, 6 1/2"
CM04-298 18.5 cm, 7 1/4"
CM04-299 20.0 cm, 8"



STANDARD OPERATING SCISSOR
CM04-300 11.5 cm, 4 1/2"
CM04-301 13.0 cm, 5"
CM04-302 14.5 cm, 5 3/4"
CM04-303 16.5 cm, 6 1/2"
CM04-304 18.5 cm, 7 1/4"
CM04-305 20.0 cm, 8"



STANDARD OPERATING SCISSOR
CM04-306 11.5 cm, 4 1/2"
CM04-307 13.0 cm, 5"
CM04-308 14.5 cm, 5 3/4"
CM04-309 16.5 cm, 6 1/2"
CM04-310 18.5 cm, 7 1/4"
CM04-311 20.0 cm, 8"



STANDARD OPERATING SCISSOR
CM04-312 11.5 cm, 4 1/2"
CM04-313 13.0 cm, 5"
CM04-314 14.5 cm, 5 3/4"
CM04-315 16.5 cm, 6 1/2"
CM04-316 18.5 cm, 7 1/4"
CM04-317 20.0 cm, 8"

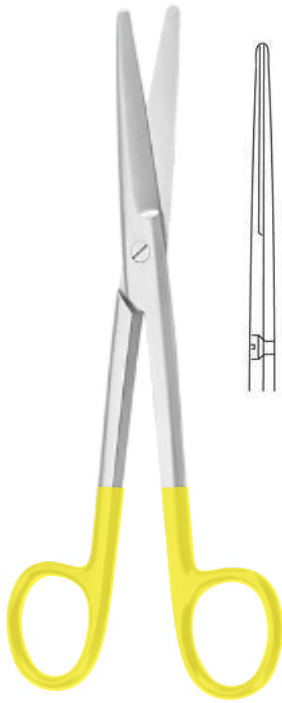

MAYO
CM04-318 14.0 cm, 5 1/2"
CM04-319 15.5.0 cm, 6"
CM04-320 17.0 cm, 6 3/4"
CM04-321 21.0 cm, 8 1/4"
CM04-322 23.0 cm, 9"

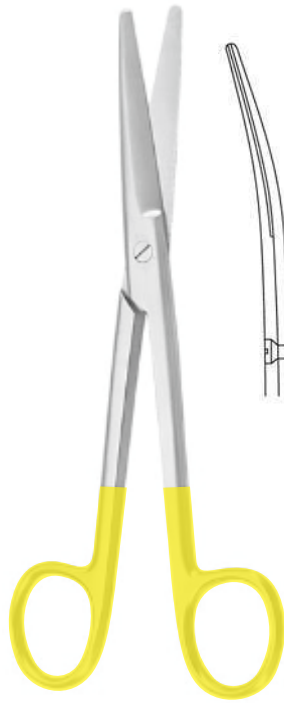

MAYO
CM04-323 14.0 cm, 5 1/2"
CM04-324 15.5.0 cm, 6"
CM04-325 17.0 cm, 6 3/4"
CM04-326 21.0 cm, 8 1/4"
CM04-327 23.0 cm, 9"

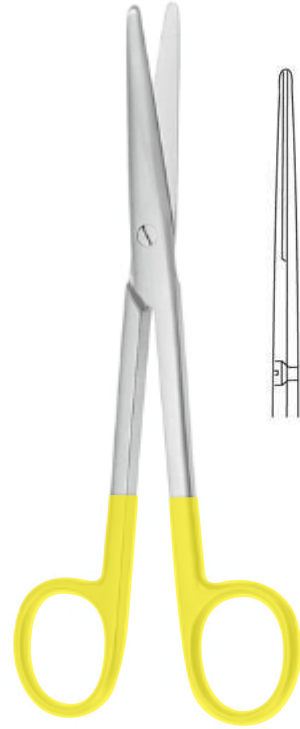

MAYO-STILLE
CM04-328 15.0 cm, 6"
CM04-329 17.0 cm, 6 3/4"

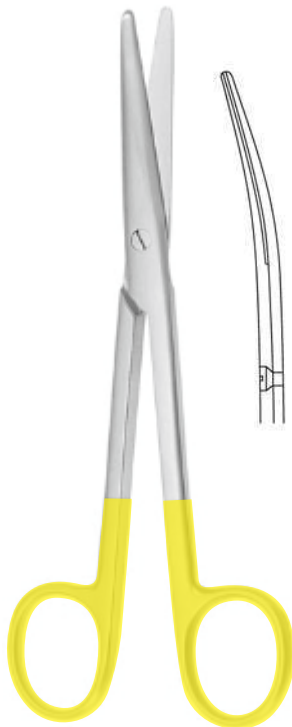

MAYO-STILLE
CM04-330 15.0 cm, 6"
CM04-331 17.0 cm, 6 3/4"



LEXER
CM04-332 16.0 cm, 6 1/4"
CM04-333 21.0 cm, 8 1/4"



LEXER
CM04-334 16.0 cm, 6 1/4"
CM04-335 21.0 cm, 8 1/4"

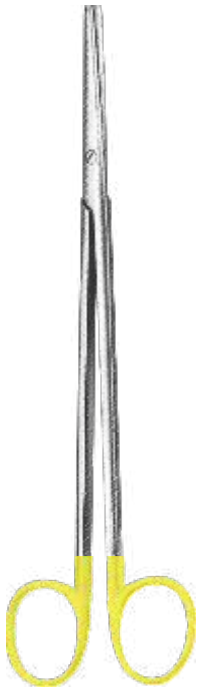

METZENBAUM
CM04-336 - CM04-341

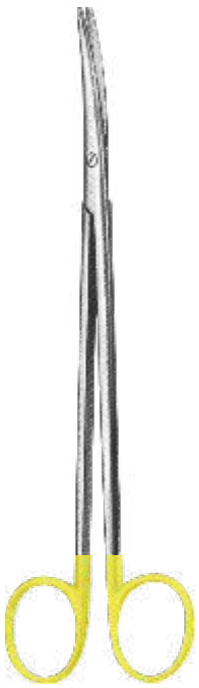
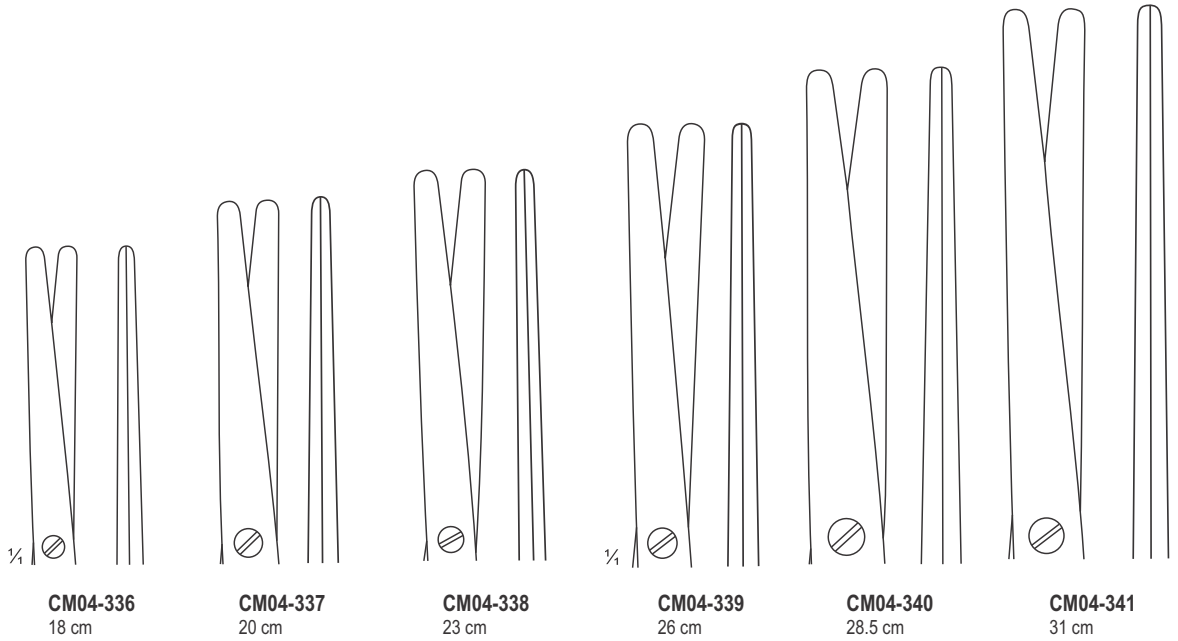

METZENBAUM
CM04-342 - CM04-347

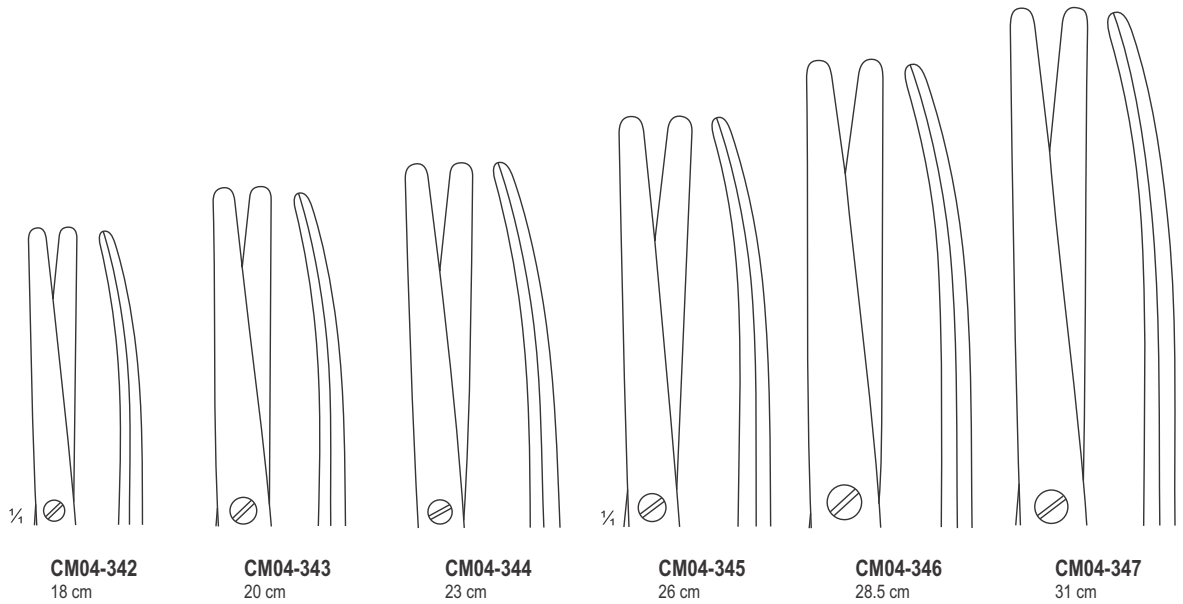

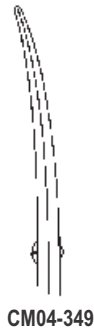
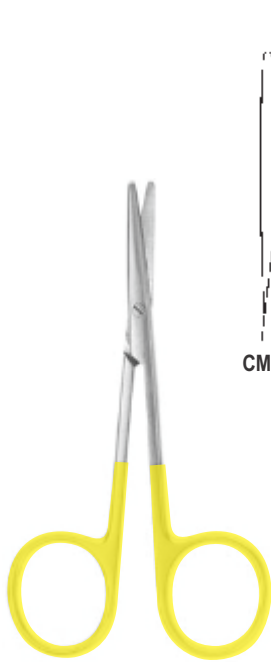

BABY-METZENBAUM
CM04-348 - CM04-349
11.5 cm, 4½"

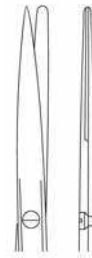

- CM04-350 14.0 cm, 5 1/2"
- CM04-351 18.0 cm, 7"
- CM04-352 20.0 cm, 8"
- CM04-353 23.0 cm, 9"
- CM04-354 25.0 cm, 10"
- CM04-355 28.0 cm, 11"
- CM04-356 30.0 cm, 12"

- CM04-357 14.0 cm, 5 1/2"
- CM04-358 18.0 cm, 7"
- CM04-359 20.0 cm, 8"
- CM04-360 23.0 cm, 9"
- CM04-361 25.0 cm, 10"
- CM04-362 28.0 cm, 11"
- CM04-363 30.0 cm, 12"

METZENBAUM
CM04-350 - CM04-363

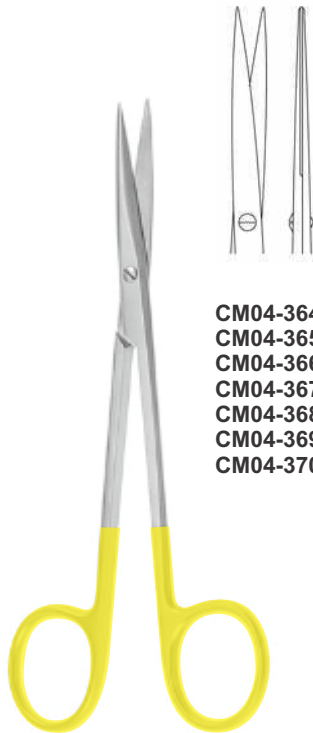

- | | |
|-----------------------|-----------------------|
| CM04-364 14.0 cm, 5" | CM04-371 14.0 cm, 5" |
| CM04-365 18.0 cm, 7" | CM04-372 18.0 cm, 7" |
| CM04-366 20.0 cm, 8" | CM04-373 20.0 cm, 8" |
| CM04-367 23.0 cm, 9" | CM04-374 23.0 cm, 9" |
| CM04-368 25.0 cm, 10" | CM04-375 25.0 cm, 10" |
| CM04-369 28.0 cm, 11" | CM04-376 28.0 cm, 11" |
| CM04-370 30.0 cm, 12" | CM04-377 30.0 cm, 12" |

METZENBAUM-FINO
CM04-364 -CM04-377

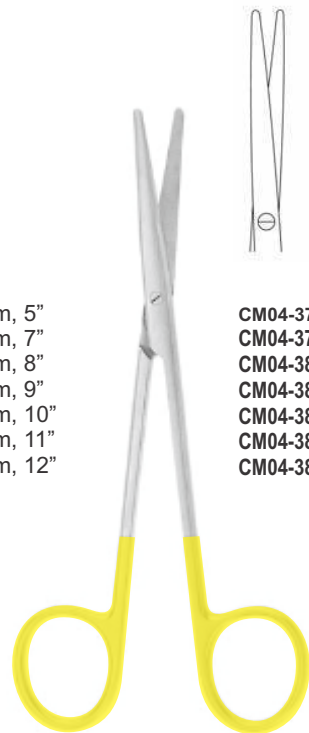

- | | |
|-----------------------|-----------------------|
| CM04-378 14.0 cm, 5" | CM04-385 14.0 cm, 5" |
| CM04-379 18.0 cm, 7" | CM04-386 18.0 cm, 7" |
| CM04-380 20.0 cm, 8" | CM04-387 20.0 cm, 8" |
| CM04-381 23.0 cm, 9" | CM04-388 23.0 cm, 9" |
| CM04-382 25.0 cm, 10" | CM04-389 25.0 cm, 10" |
| CM04-383 28.0 cm, 11" | CM04-390 28.0 cm, 11" |
| CM04-384 30.0 cm, 12" | CM04-391 30.0 cm, 12" |

METZENBAUM-FINO
CM04-378 -CM04-391

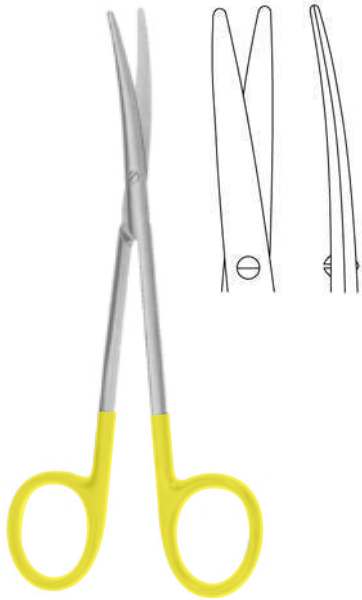

METZENBAUM-LAHEY
CM04-392
14.5 cm, 5½"

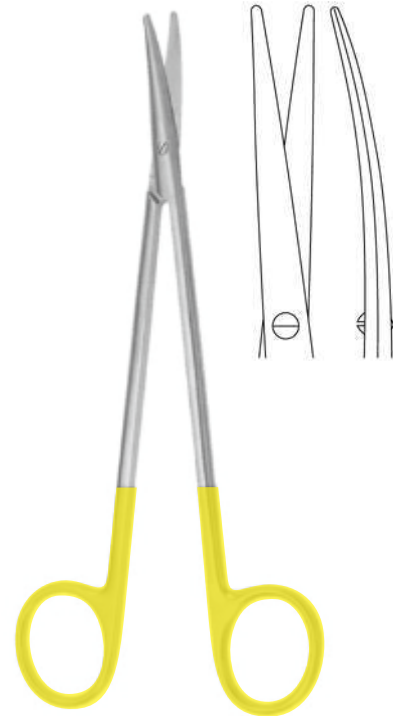

TOENNIS-ADSON
CM04-393
17.0 cm, 6 3/4"



CM04-394 20.0 cm, 8"
CM04-395 23.0 cm, 9"

SIMS
CM04-394 - CM04-395



CM04-396 20.0 cm, 8"
CM04-397 23.0 cm, 9"

SIMS
CM04-396 - CM04-397

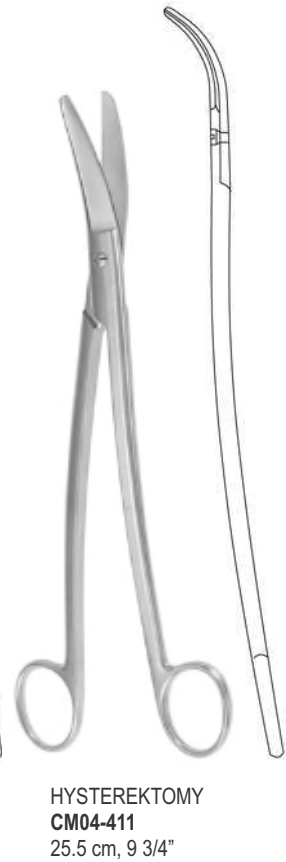
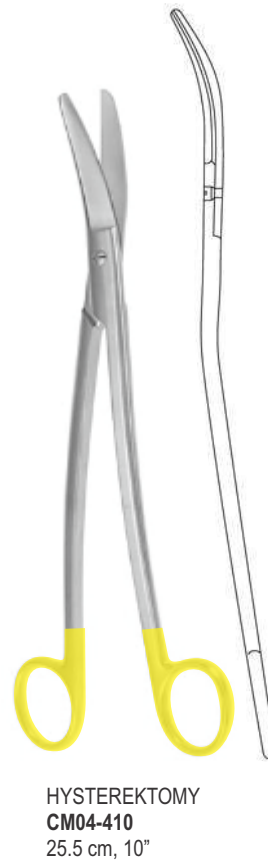
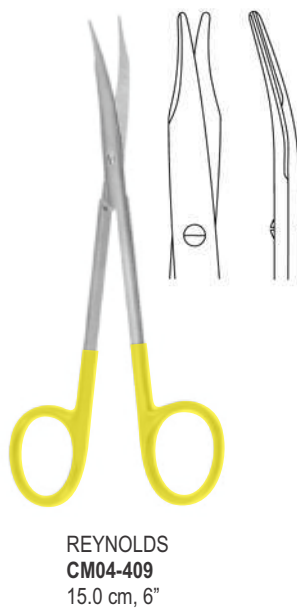
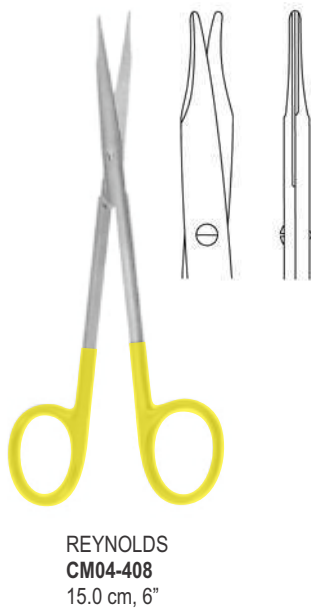
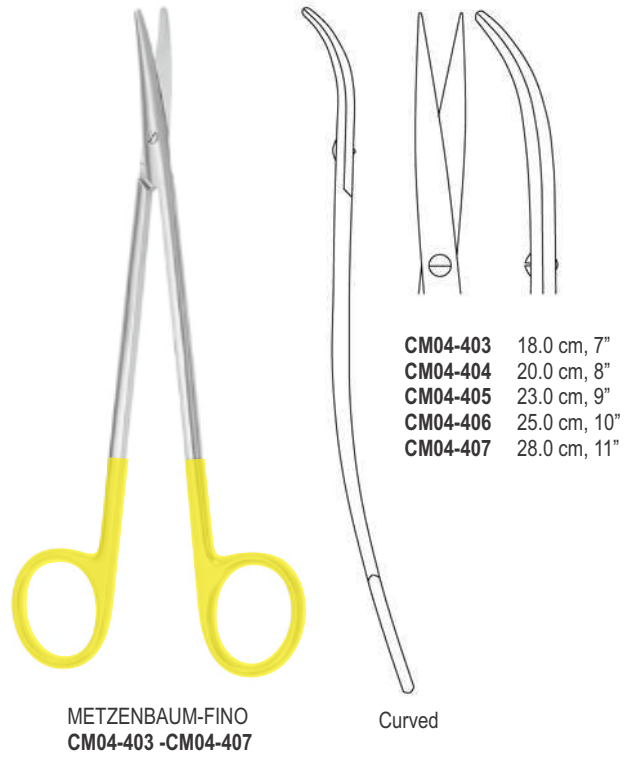
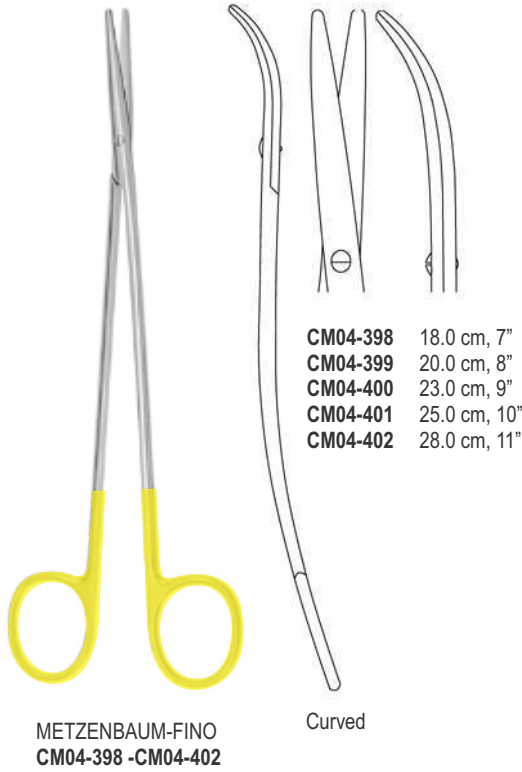

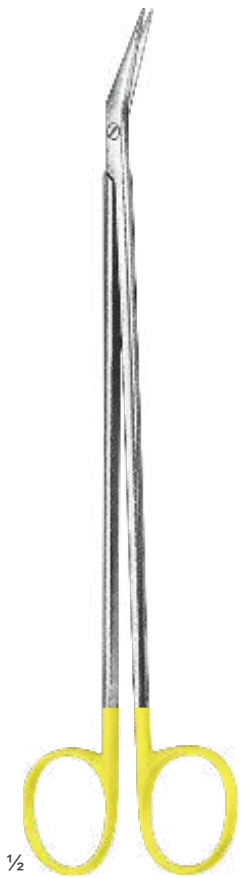

DE BAKEY
CM04-412 - CM04-417

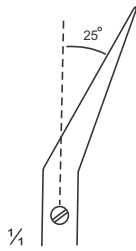

CM04-412
19 cm

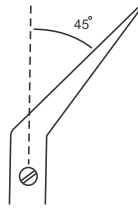

CM04-413
18.5 cm

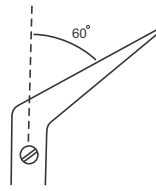

CM04-414
18 cm

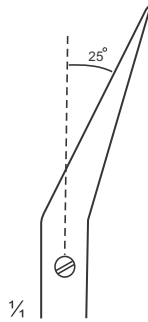

CM04-415
23 cm

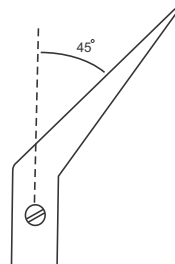

CM04-416
23 cm

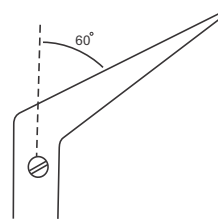

CM04-417
22 cm

HYSTEREKTOMY
CM04-418
25.5 cm, 9 3/4"

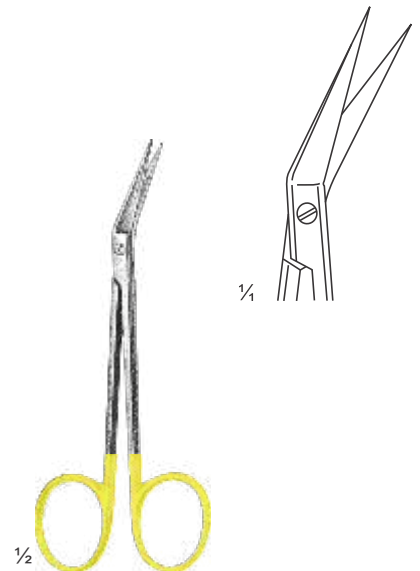

CM04-419
11 cm



DIETHRICH-HEGEMANN
CM04-420 - CM04-424
 18.0 cm, 7"

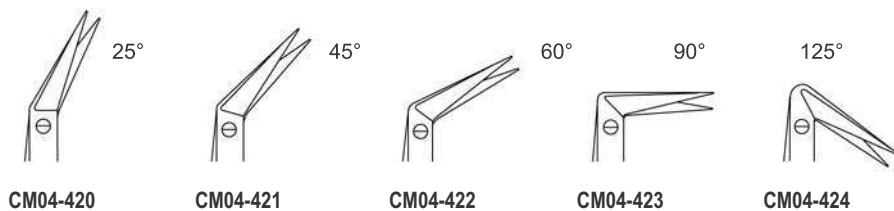

POTTS-SMITH
CM04-425 - CM04-427
 18.0 cm, 7½"

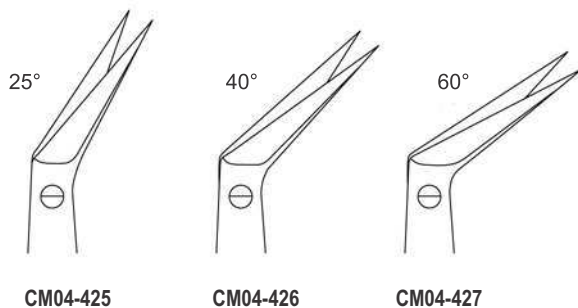

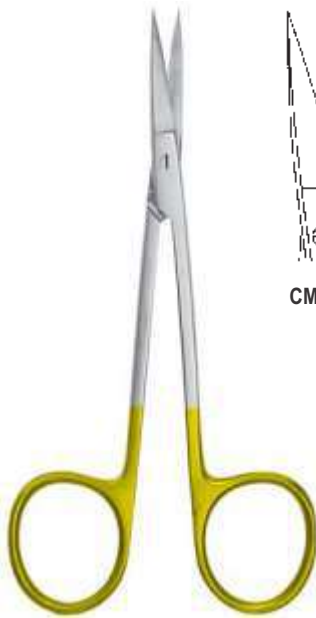

CM04-428

CM04-429

IRIS
CM04-428 - CM04-429
11.5 cm, 4 1/2"



gezahnt
serrated
dentada
dentata

UNIVERSAL
CM04-430
12.0 cm, 4 3/4"



LISTER
CM04-431
18.0 cm, 7"

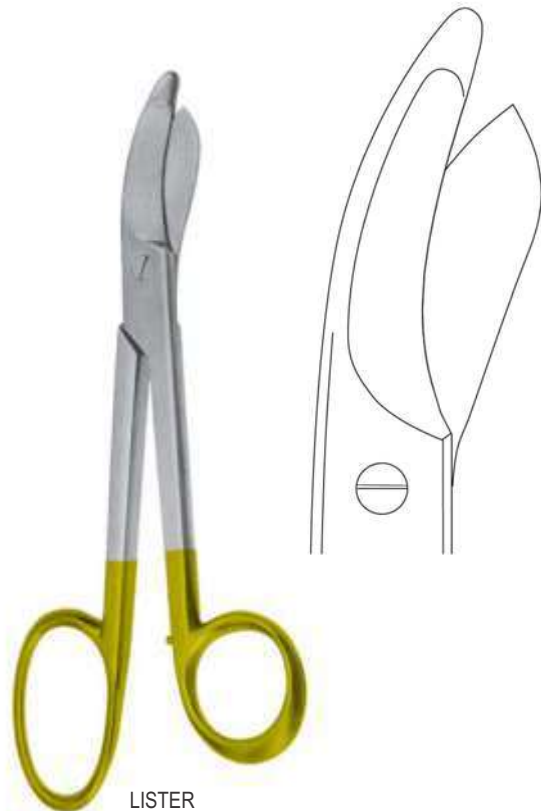

LISTER
CM04-432
24.0 cm, 9 1/2"

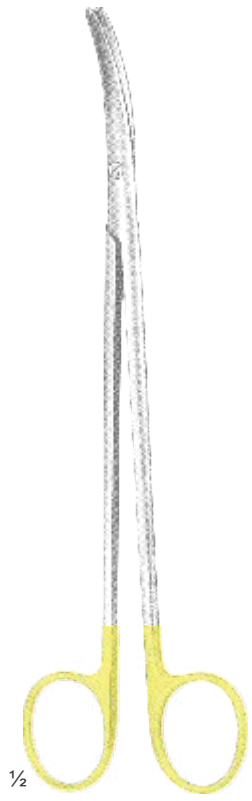

1/2

METZENBAUM-THOREK
CM04-433 - CM04-435

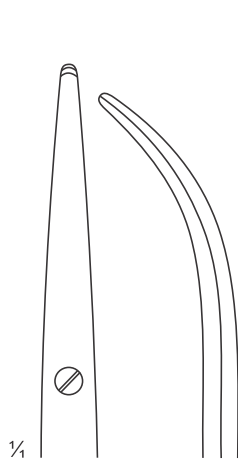

1/4

CM04-433
200 mm

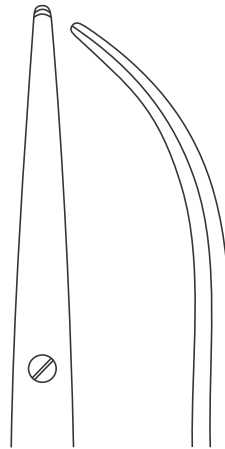

CM04-434
230 mm

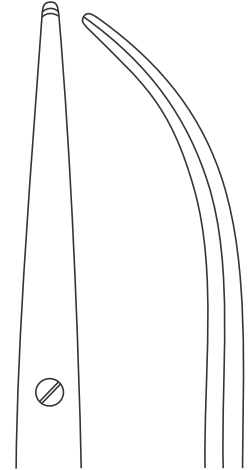

CM04-435
280 mm



1/2

JOSEPH
CM04-436 - CM04-437



1/4

CM04-436
14.5 cm

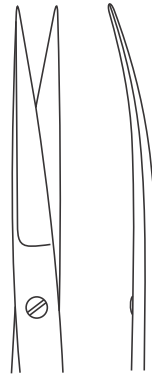

CM04-437
14.5 cm

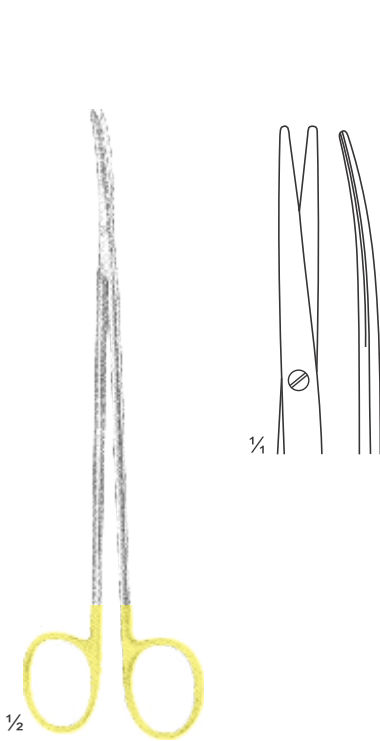

TOENNIS-ADSON
CM04-438
175 mm
slender pattern

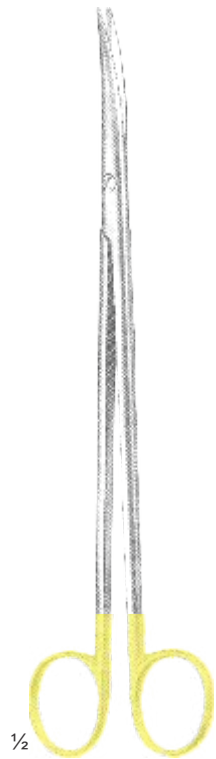

METZENBAUM-FINO
CM04-439 - CM04-440
slender pattern

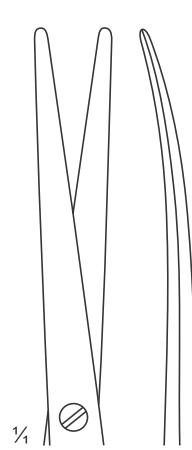

CM04-439
205 mm

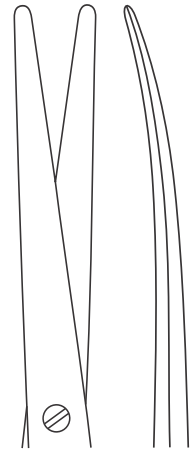

CM04-440
230 mm

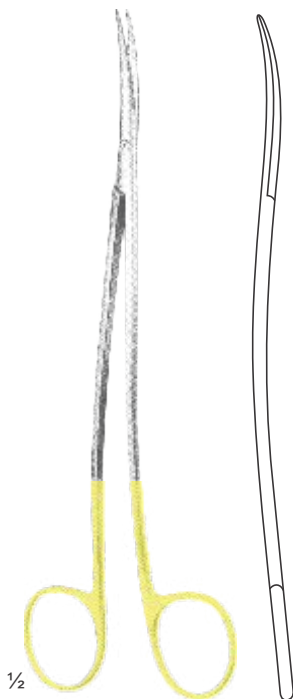

METZENBAUM-FINO
CM04-441 - CM04-443
slender pattern



CM04-441
180 mm



CM04-442
205 mm

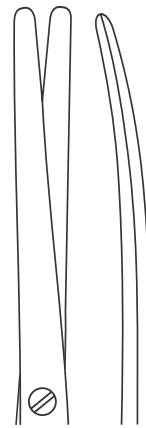

CM04-443
230 mm

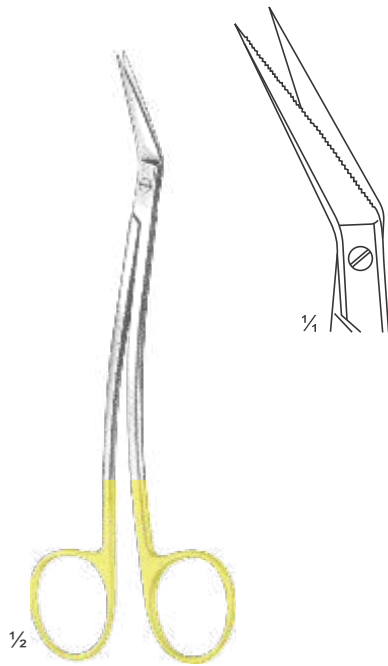

LOCKLIN
CM04-444
160 mm
one toothed cutting edge

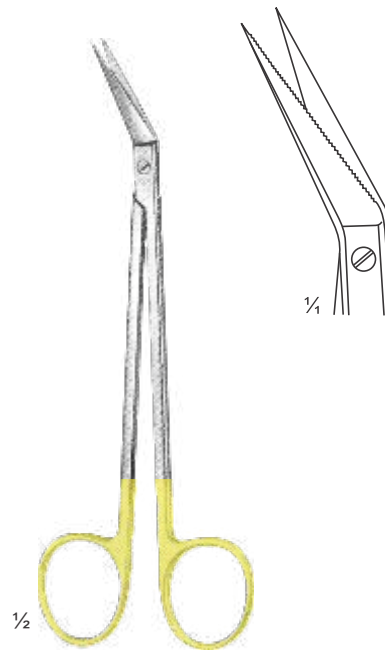

LOCKLIN
CM04-445
160 mm
one toothed cutting edge



MAYO
CM04-446 - CM04-447
17.0 cm, 6 3/4"

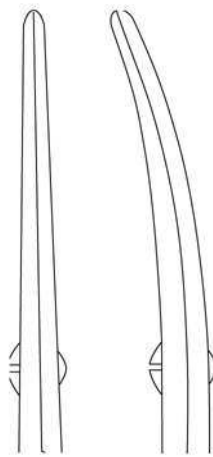

CM04-446 CM04-447

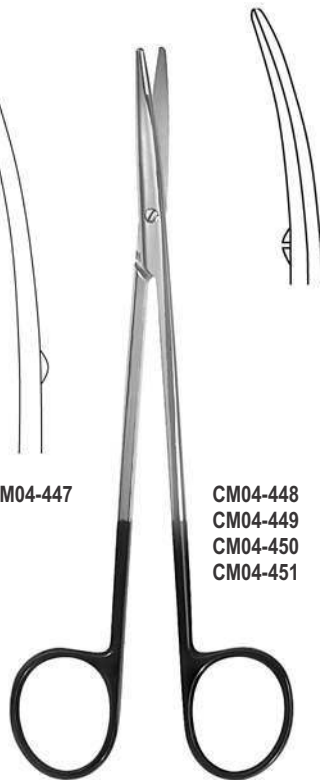

METZENBAUM
CM04-448 - CM04-451

CM04-448 14.5 cm, 5 3/4"
CM04-449 18.0 cm, 7"
CM04-450 20.0 cm, 8"
CM04-451 23.0 cm, 9"

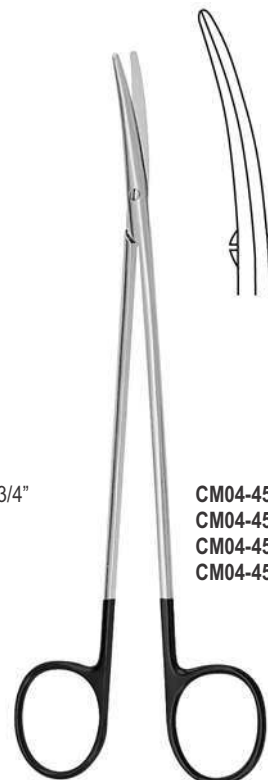

METZENBAUM-FINO
CM04-452 - CM04-455

CM04-452 14.5 cm, 5 3/4"
CM04-453 18.0 cm, 7"
CM04-454 20.0 cm, 8"
CM04-455 23.0 cm, 9"



KAYE FACE LIFT
CM04-456 - CM04-457



CM04-456 15.0 cm, 6"
CM04-457 19.0 cm, 7 1/2"



JABALEY
CM04-458
13.0 cm, 5"



ENDARTERECTOMY
CM04-459
18.0 cm, 7"



TOENNIS-ADSON
CM04-460
17.0 cm, 6 3/4"

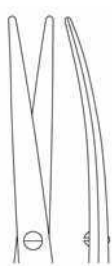



STRABISMUS
CM04-461 - CM04-462
 11.5 cm, 4½"



JAMISON
CM04-463 15.0 cm, 6"
CM04-464 18.0 cm, 7"



REYNOLDS
CM04-465
 12.5 cm, 5"



BABY-METZENBAUM
CM04-466 11.0 cm, 4 3/8"
CM04-467 14.5 cm, 5 3/4"



IRIS
CM04-468
 11.0 cm, 4 3/8"



IRIS
CM04-469
 11.0 cm, 4 3/8"



STEVENS TENOTOMY
CM04-470
 11.0 cm, 4 3/8"



STEVENS TENOTOMY
CM04-471
 11.0 cm, 4 3/8"



PAR TYPE
CM04-472
12.0 cm, 4 3/4"



PAR TYPE
CM04-473
12.0 cm, 4 3/4"

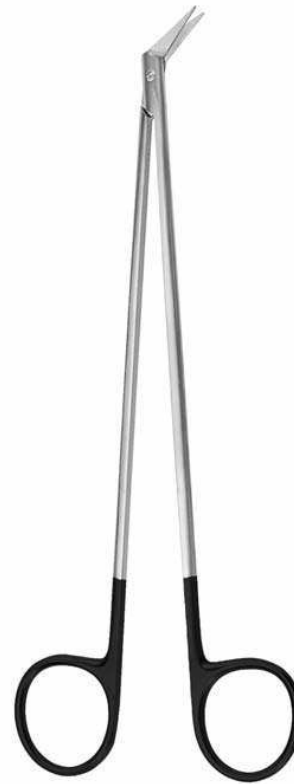

POTTS
CM04-474 - CM04-476
19.0 cm, 7 1/2"

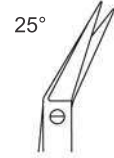

CM04-474



CM04-475



CM04-476



CM04-477
14.5 cm, 5 3/4"

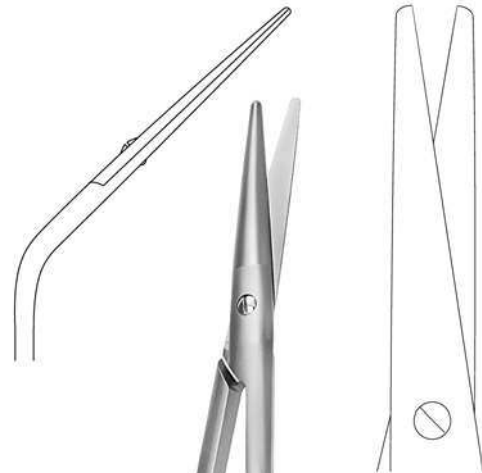

COTTLE
CM04-478
16.5 cm, 6 1/2"



CM04-479
14.5 cm



CM04-480
18 cm



CM04-481
20.5 cm

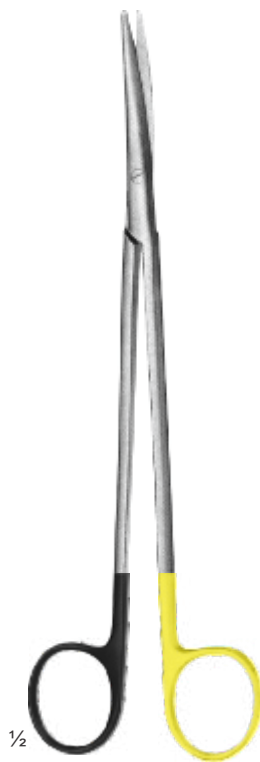

1/2



CM04-482
23 cm



CM04-483
25 cm



CM04-484
30 cm

LIGATURE SCISSORS
CM04-479 - CM04-484
 for synthetic suture material,
 one toothed cutting edge



LIGATURE SCISSORS
CM04-485 - CM04-487
for synthetic suture material,
one toothed cutting edge



CM04-485
14.5 cm



CM04-486
17 cm



CM04-487
23 cm

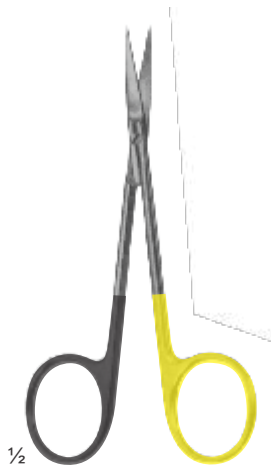

IRIS
CM04-488
11.5 cm



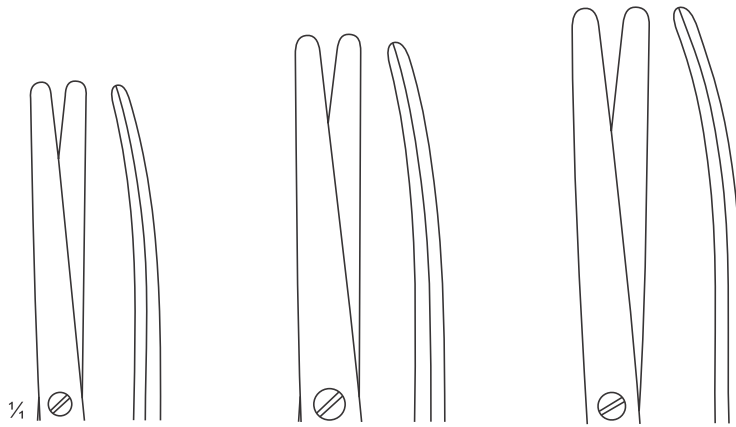

CM04-489
18 cm

CM04-490
20 cm

CM04-491
23 cm

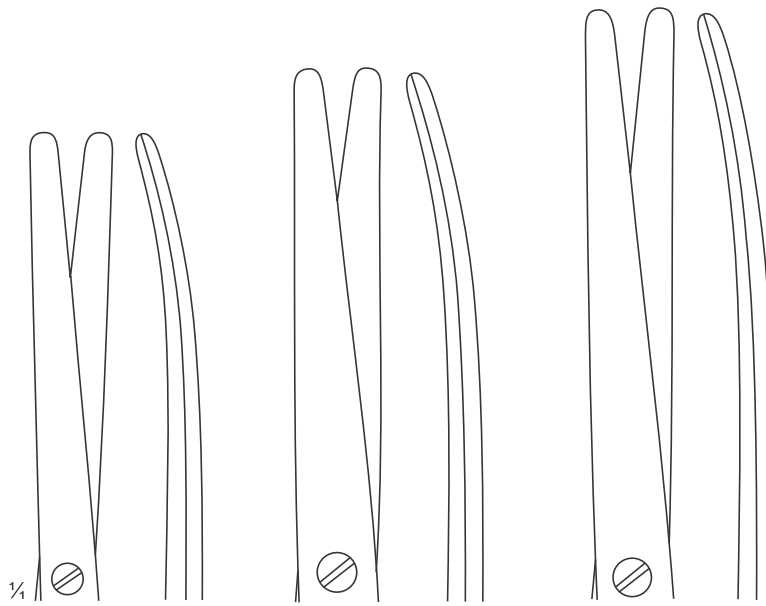

CM04-492
26 cm

CM04-493
28.5 cm

CM04-494
31 cm

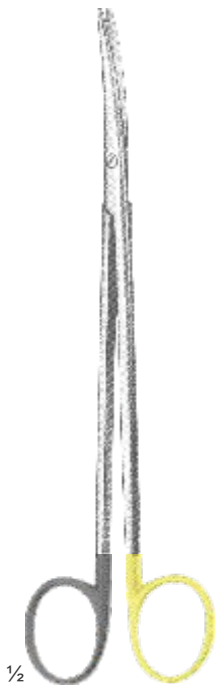

METZENBAUM
CM04-489 - CM04-494



UMBILICAL CORD
CM04-495
10 cm





CARE MEDICAL[®]
S U P P L I E S

Your health _ Our Priority

Section

05

Page 69-86

Forceps For Grasping Tissue And Tumors
Micro Forceps, Jeweler Types
Ligature Forceps, Micro Forceps (light Patterns)
Delicate Tissue Forceps
Splinter And Cilia Forceps
Tissue Forceps With Tungsten Carbide Inserts

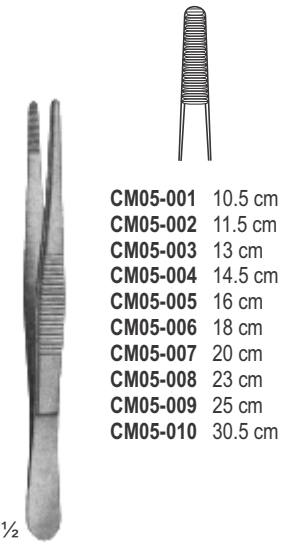

- CM05-001** 10.5 cm
- CM05-002** 11.5 cm
- CM05-003** 13 cm
- CM05-004** 14.5 cm
- CM05-005** 16 cm
- CM05-006** 18 cm
- CM05-007** 20 cm
- CM05-008** 23 cm
- CM05-009** 25 cm
- CM05-010** 30.5 cm

Standard (Thumb)
CM05-001 - CM05-010
11.5 cm

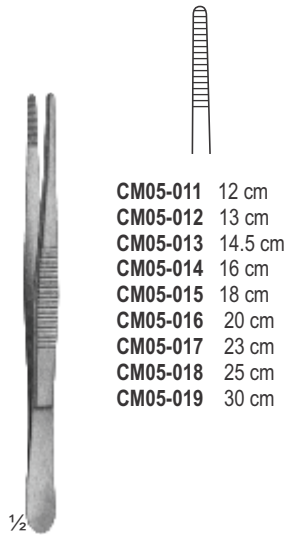

- CM05-011** 12 cm
- CM05-012** 13 cm
- CM05-013** 14.5 cm
- CM05-014** 16 cm
- CM05-015** 18 cm
- CM05-016** 20 cm
- CM05-017** 23 cm
- CM05-018** 25 cm
- CM05-019** 30 cm

Narrow (Thumb)
CM05-011 - CM05-019
12 cm

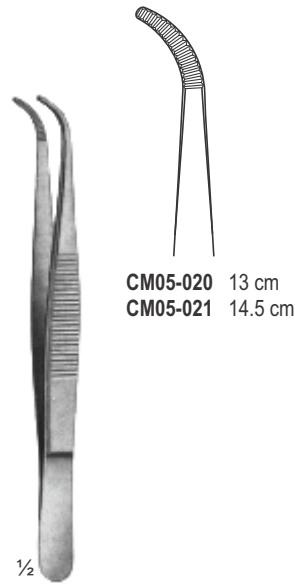

- CM05-020** 13 cm
- CM05-021** 14.5 cm

Narrow
CM05-020 - CM05-021
13 cm
Curved

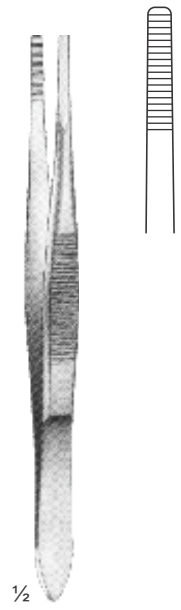

Stille
CM05-022
15 cm

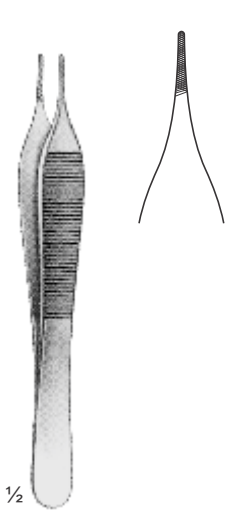

Adson
CM05-023
12 cm

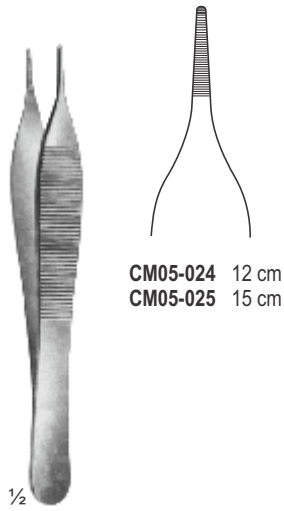

- CM05-024** 12 cm
- CM05-025** 15 cm

Adson
CM05-024 - CM05-025
12 cm

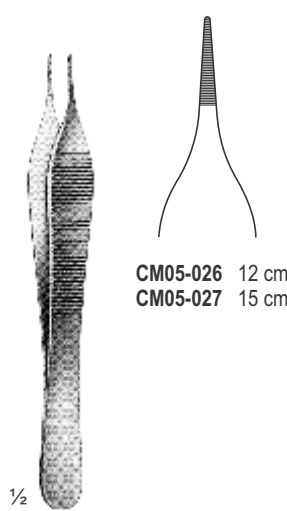





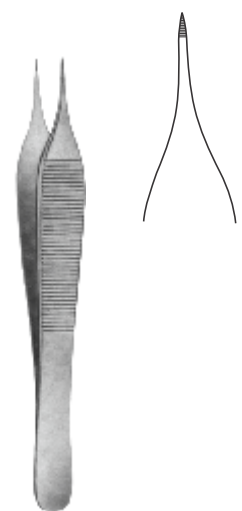



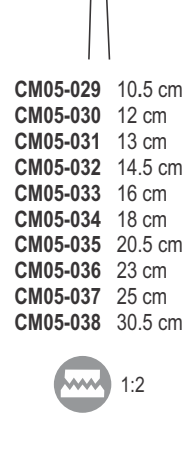

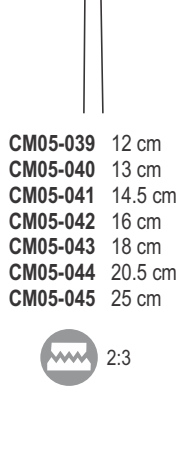

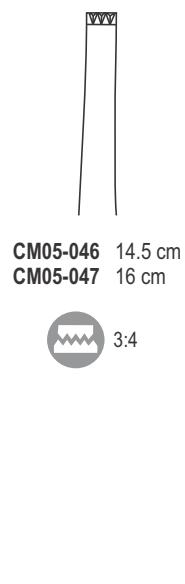

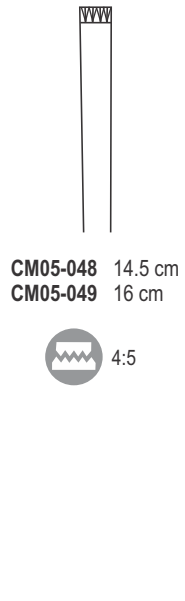

- CM05-026** 12 cm
- CM05-027** 15 cm

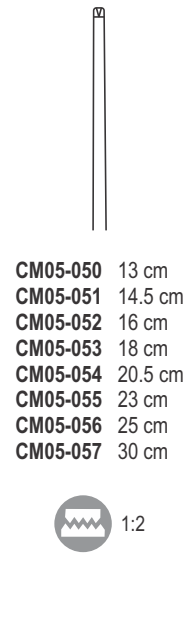
Micro-Adson
CM05-026 - CM05-027
12 cm

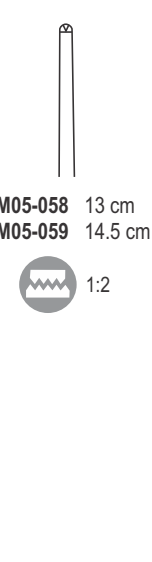

Thorek
CM05-028
12 cm
Corneal forceps

 <p>Standard (Tissue) CM05-029 - CM05-038 12 cm</p>	 <p>CM05-029 10.5 cm CM05-030 12 cm CM05-031 13 cm CM05-032 14.5 cm CM05-033 16 cm CM05-034 18 cm CM05-035 20.5 cm CM05-036 23 cm CM05-037 25 cm CM05-038 30.5 cm</p> <p>1:2</p>	 <p>CM05-039 - CM05-045 12 cm</p>	 <p>CM05-039 12 cm CM05-040 13 cm CM05-041 14.5 cm CM05-042 16 cm CM05-043 18 cm CM05-044 20.5 cm CM05-045 25 cm</p> <p>2:3</p>	 <p>CM05-046 - CM05-047 14.5 cm</p>	 <p>CM05-046 14.5 cm CM05-047 16 cm</p> <p>3:4</p>	 <p>CM05-048 - CM05-049 14.5 cm</p>	 <p>CM05-048 14.5 cm CM05-049 16 cm</p> <p>4:5</p>
--	---	--	--	--	---	--	---

 <p>CM05-050 - CM05-057 Medium 13 cm</p>	 <p>CM05-050 13 cm CM05-051 14.5 cm CM05-052 16 cm CM05-053 18 cm CM05-054 20.5 cm CM05-055 23 cm CM05-056 25 cm CM05-057 30 cm</p> <p>1:2</p>	 <p>CM05-058 - CM05-059 13 cm</p>	 <p>CM05-058 13 cm CM05-059 14.5 cm</p> <p>1:2</p>	 <p>Stille CM05-060 15 cm</p>	 <p>1:2</p>	 <p>Stille CM05-061 15 cm</p>	 <p>2:3</p>	 <p>Gillies CM05-062 15.5 cm</p>	 <p>1:2</p>
---	---	--	---	--	--	--	--	---	--

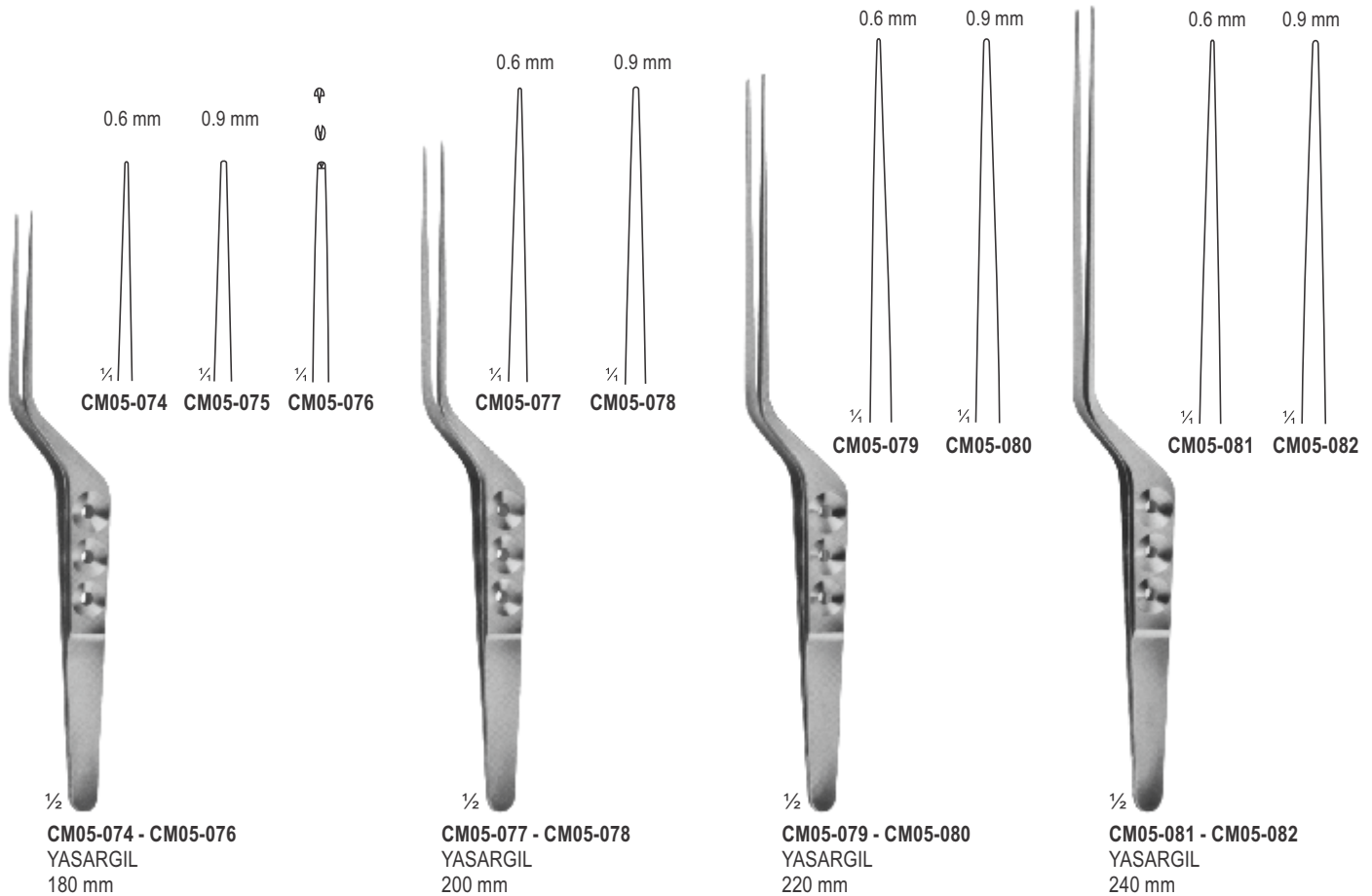
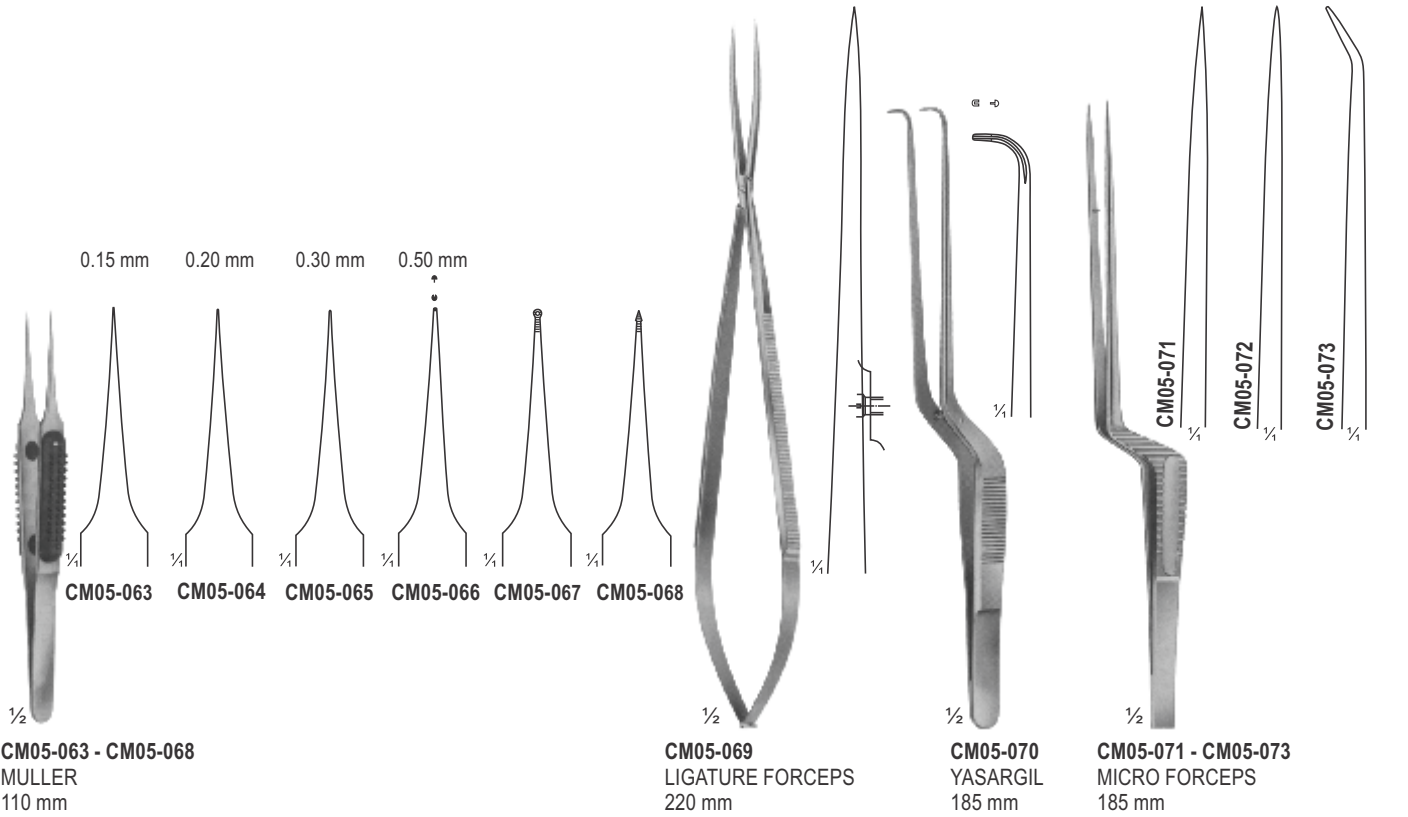

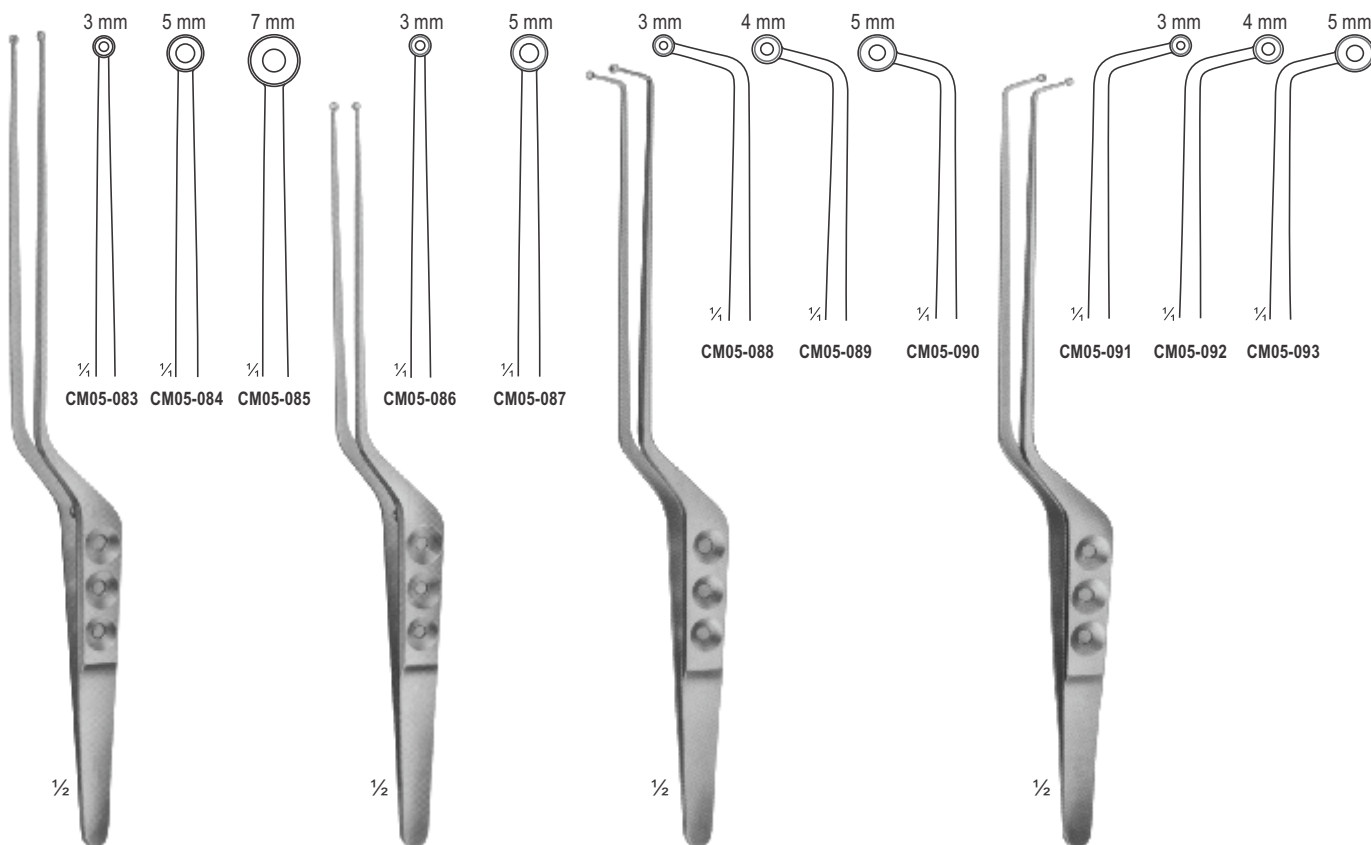

CM05-083 - CM05-085
YASARGIL-SAMI
Jaws Spoon-Shaped
240 mm

CM05-086 - CM05-087
YASARGIL
Jaws Spoon-Shaped
220 mm

CM05-088 - CM05-090
SAMII
Jaws Spoon-Shaped
230 mm

CM05-091 - CM05-093
SAMII
Jaws Spoon-Shaped
230 mm

CM05-094
HUNT 1/2
Tumor-and Vessel Forceps
200 mm

CM05-095
HUNT 1/2
Tumor-and Vessel Forceps
200 mm

CM05-096
YASARGIL 1/2
Tumor-and Vessel Forceps
200 mm

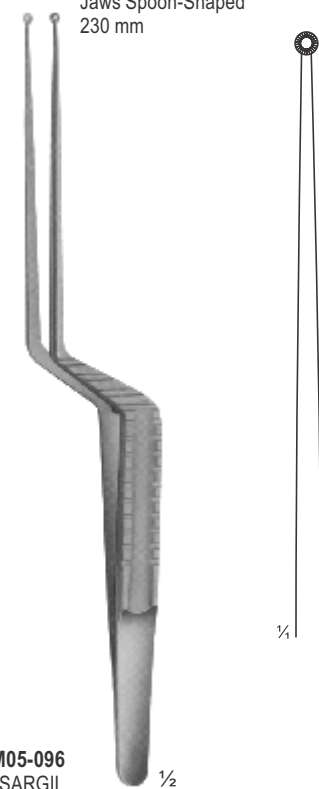
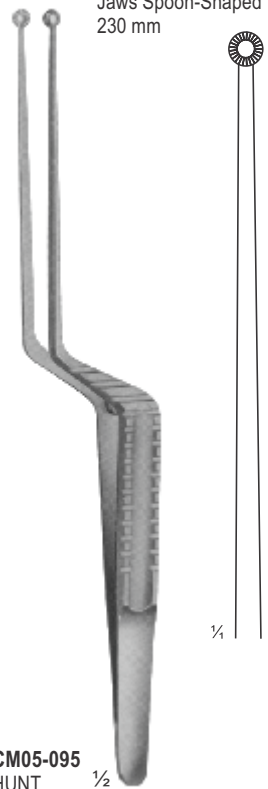
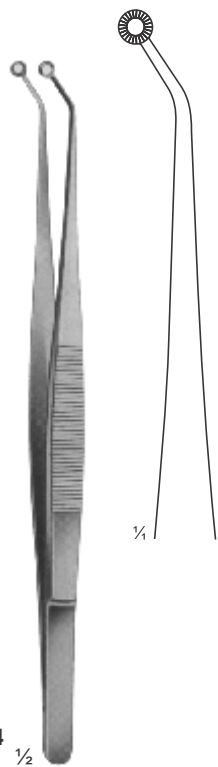

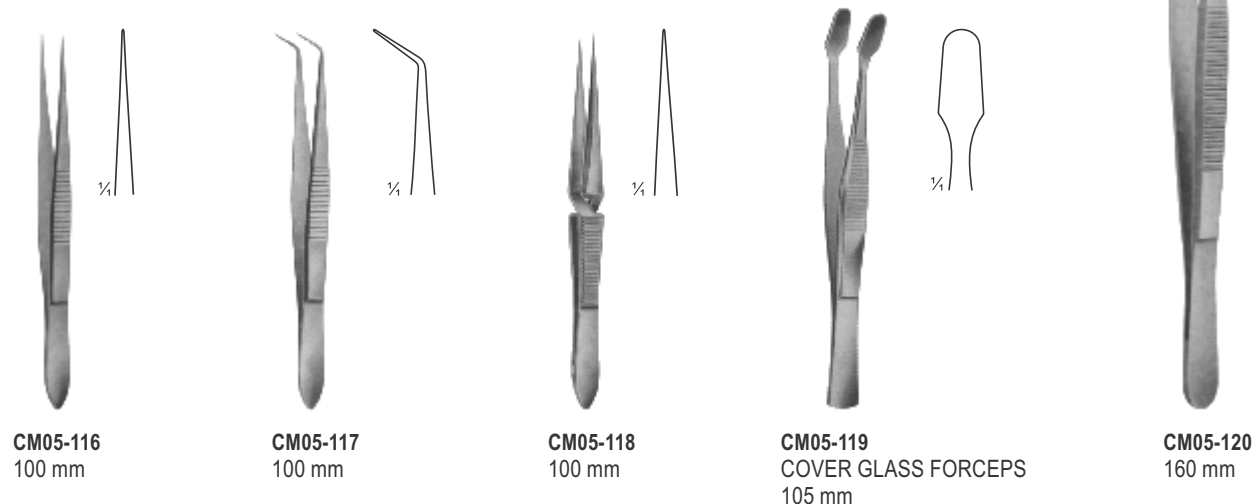
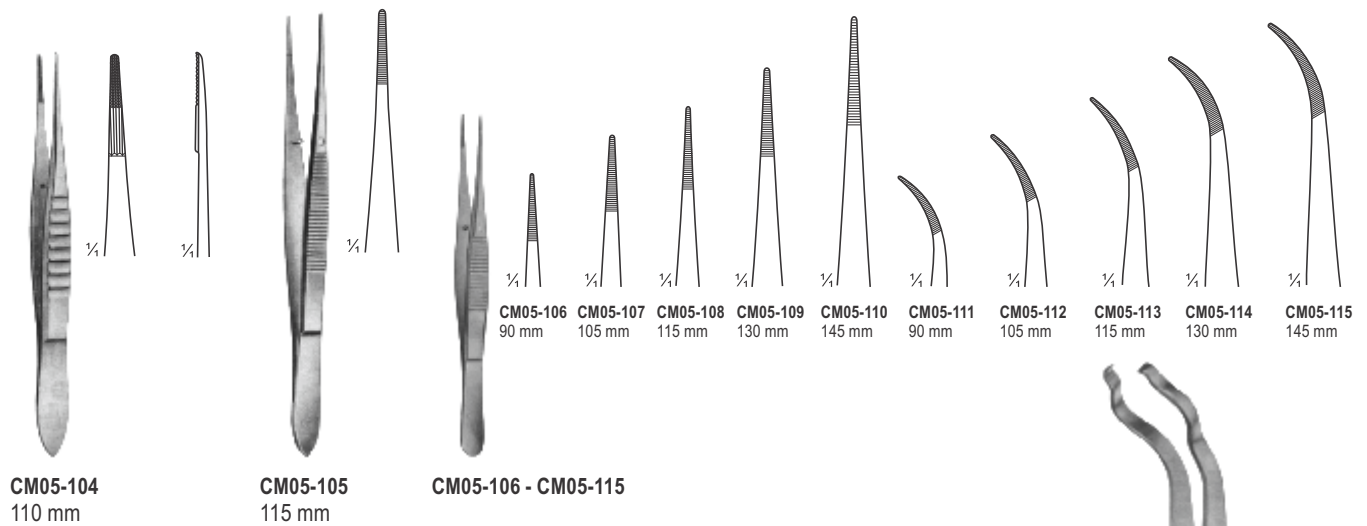
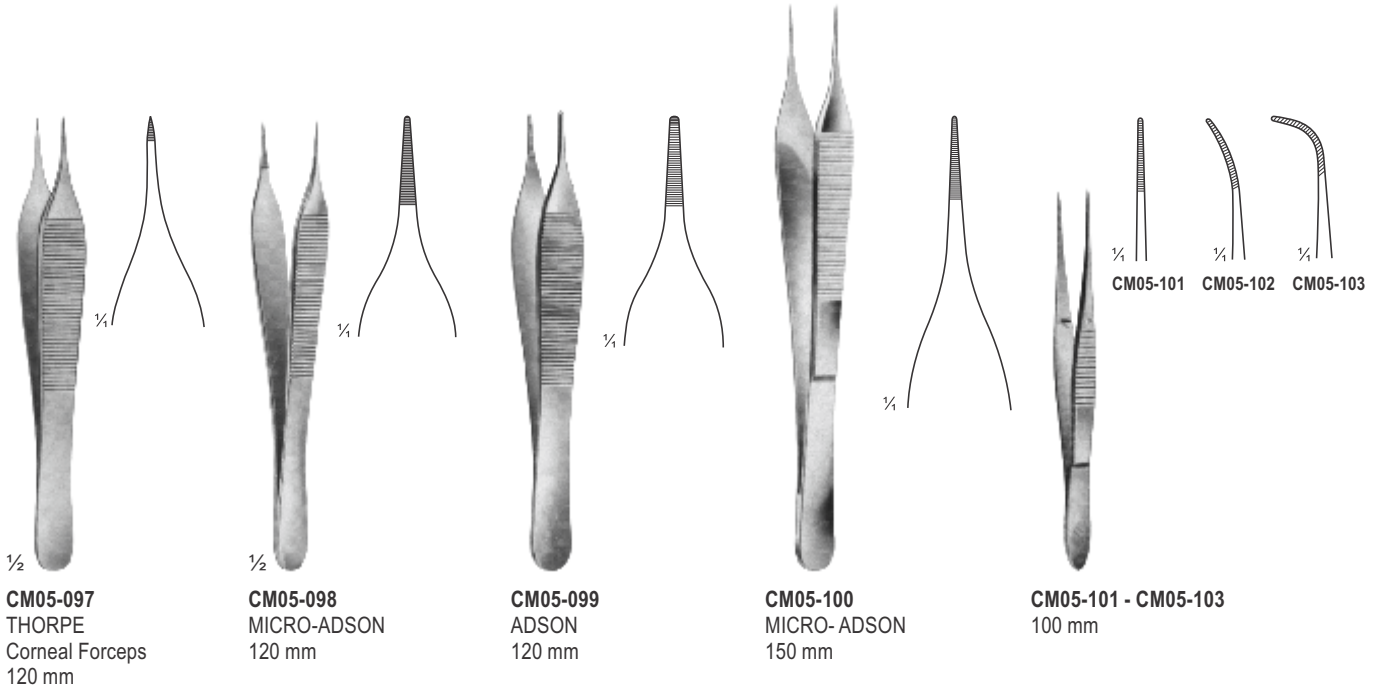

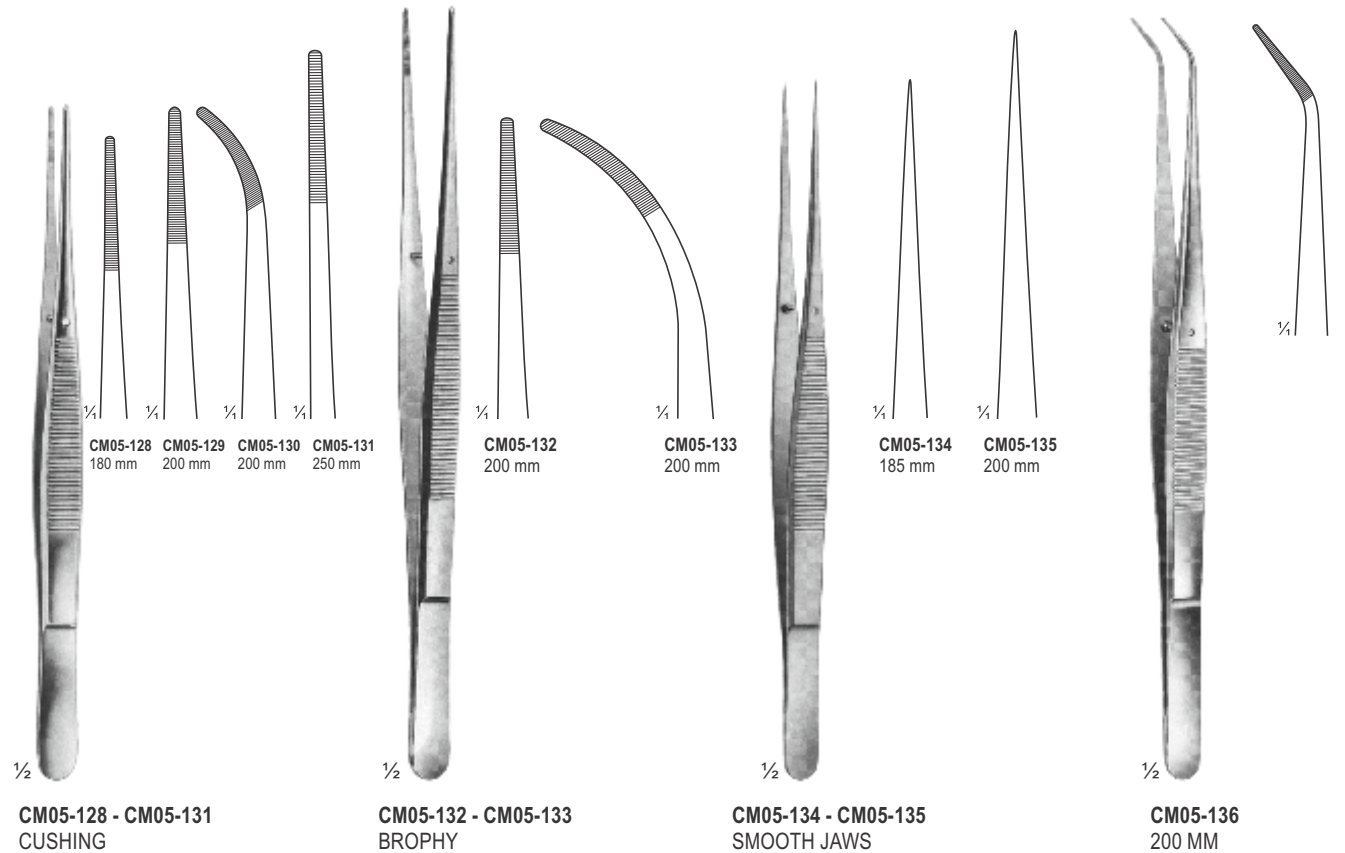
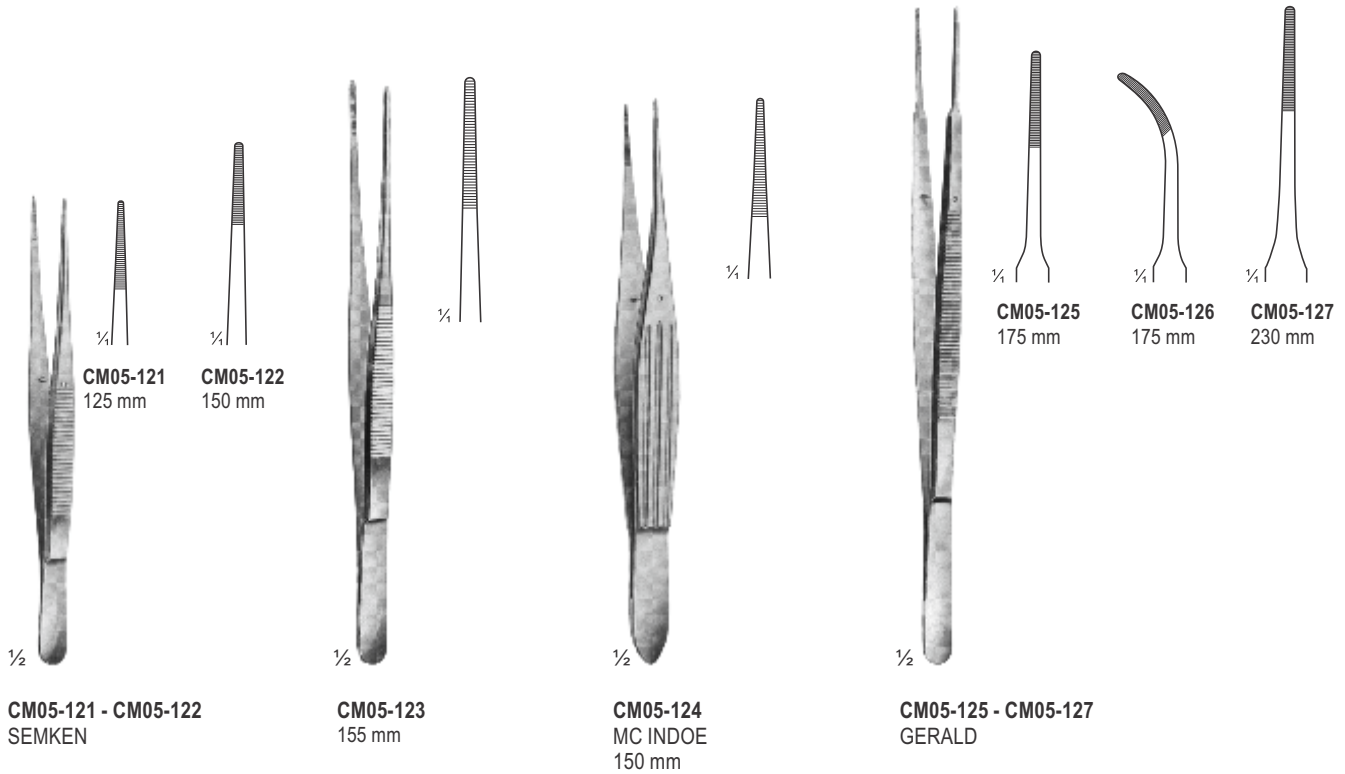

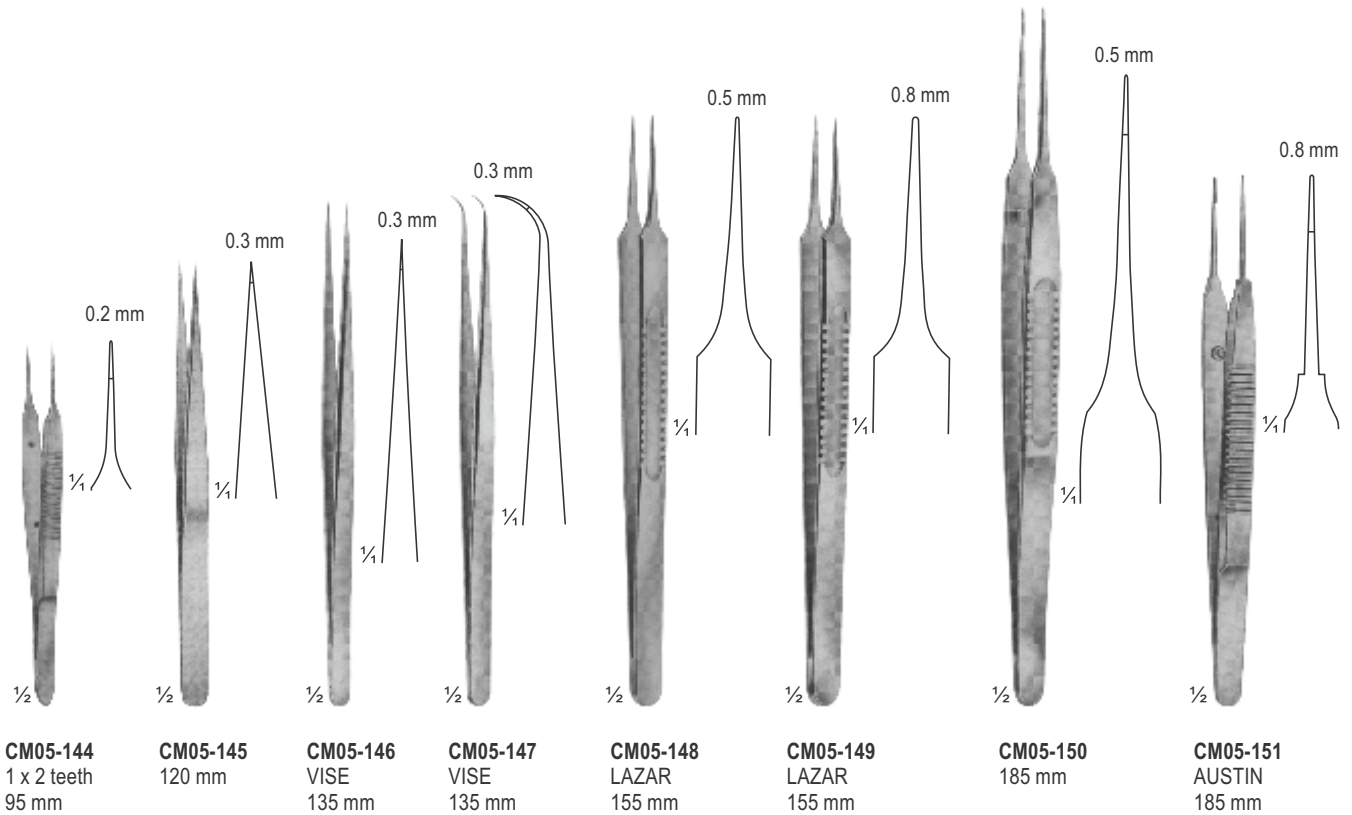
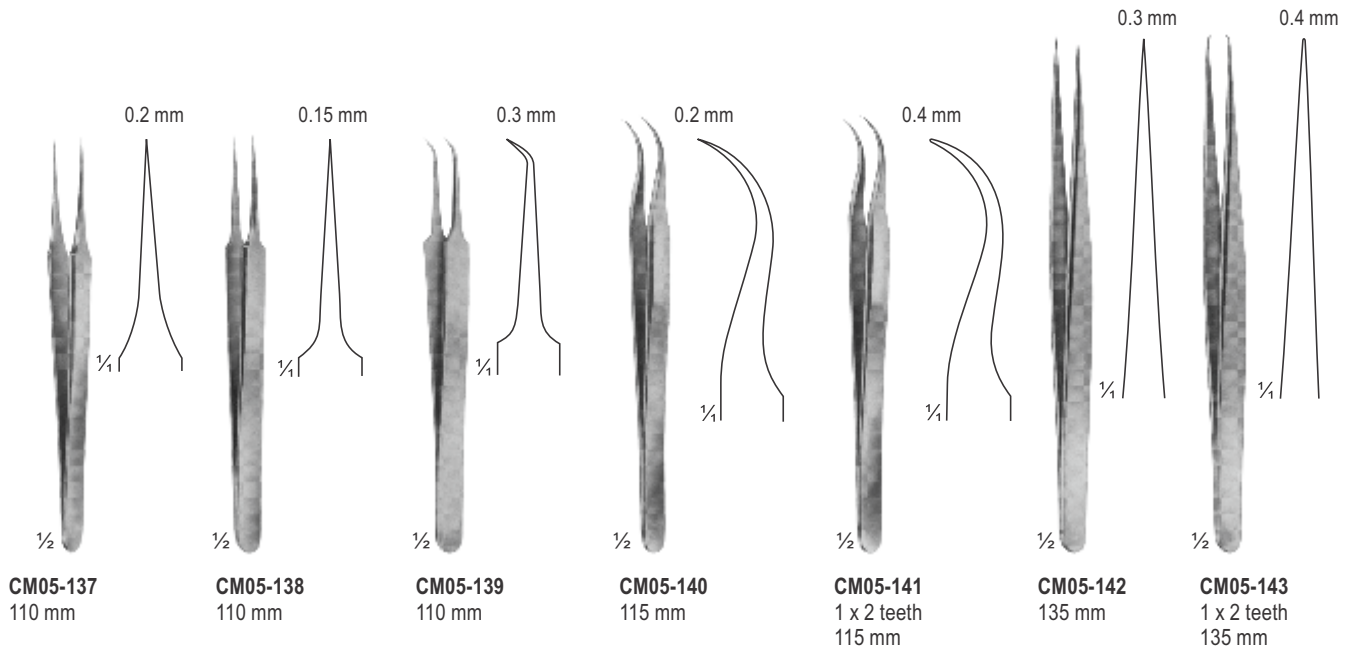

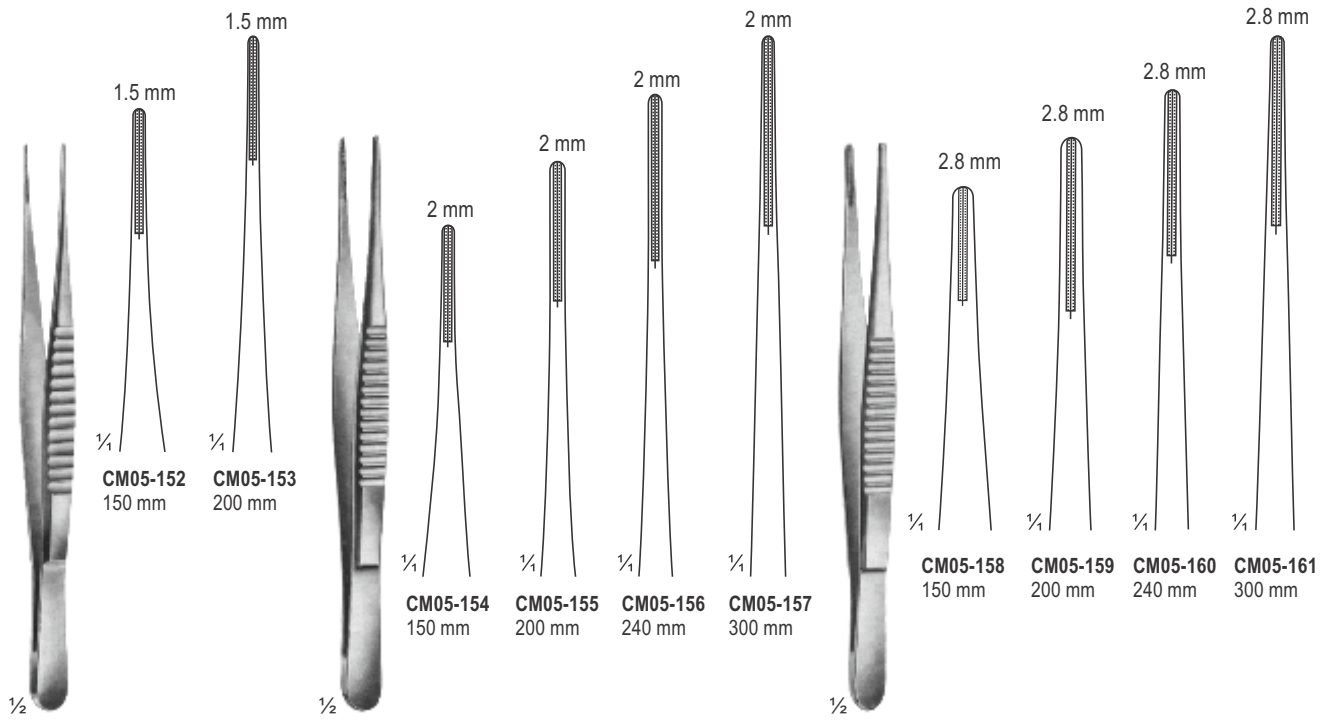

CM05-152 - CM05-153
DE BAKEY

CM05-154 - CM05-157
DE BAKEY

CM05-158 - CM05-161
DE BAKEY

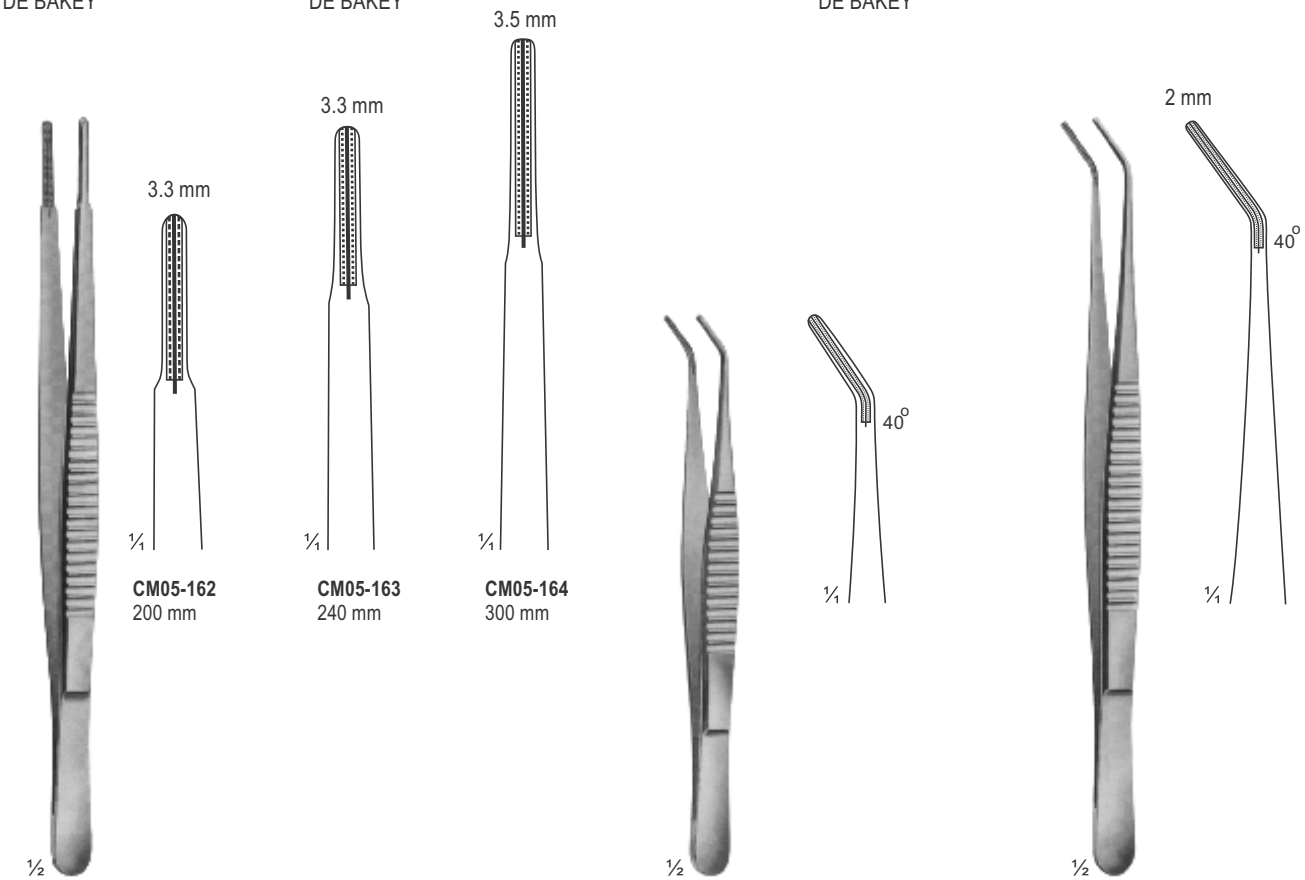

CM05-162 - CM05-164
DE BAKEY

CM05-165
DE BAKEY
150 MM

CM05-166
DE BAKEY
220 MM

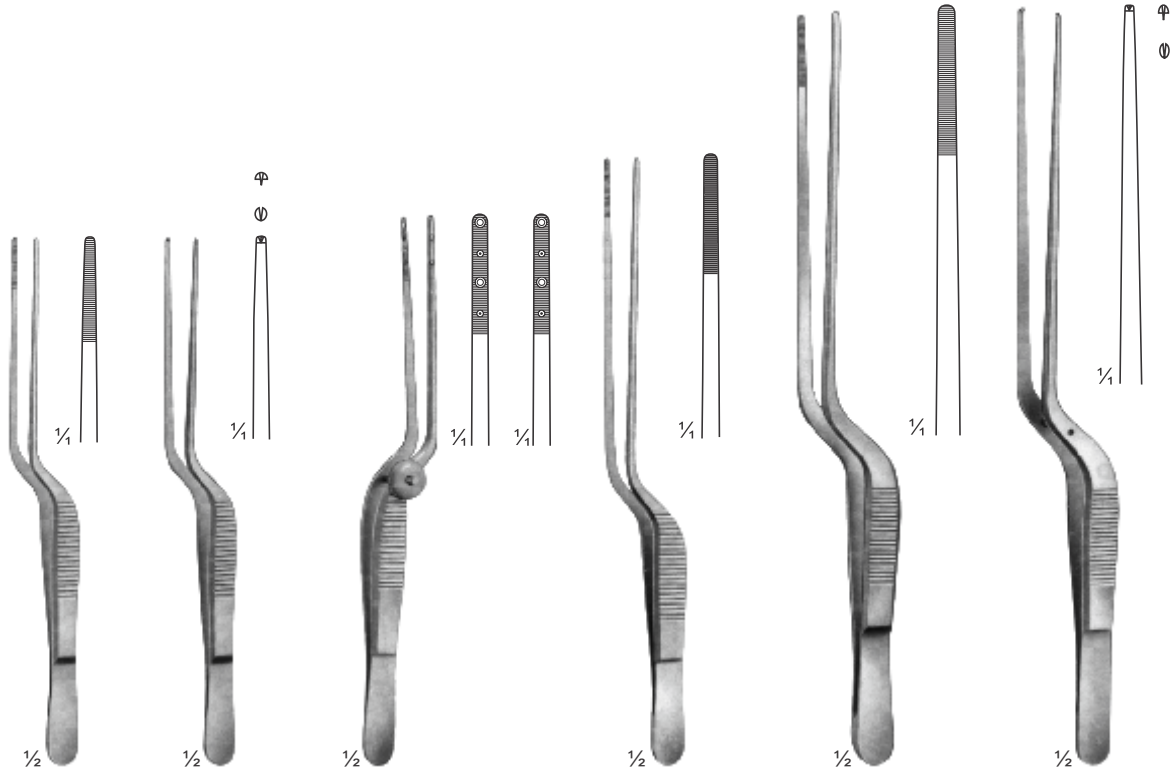

CM05-167
LUCAE
140 mm

CM05-168
LUCAE
1x2 teeth
140 mm

CM05-169
COTTLE
Forceps with
jaws toothed
and serrated
140 mm

CM05-170
JANSEN
160 mm

CM05-171
GRUENWALD
200 mm

CM05-172
1x2 teeth
200 mm

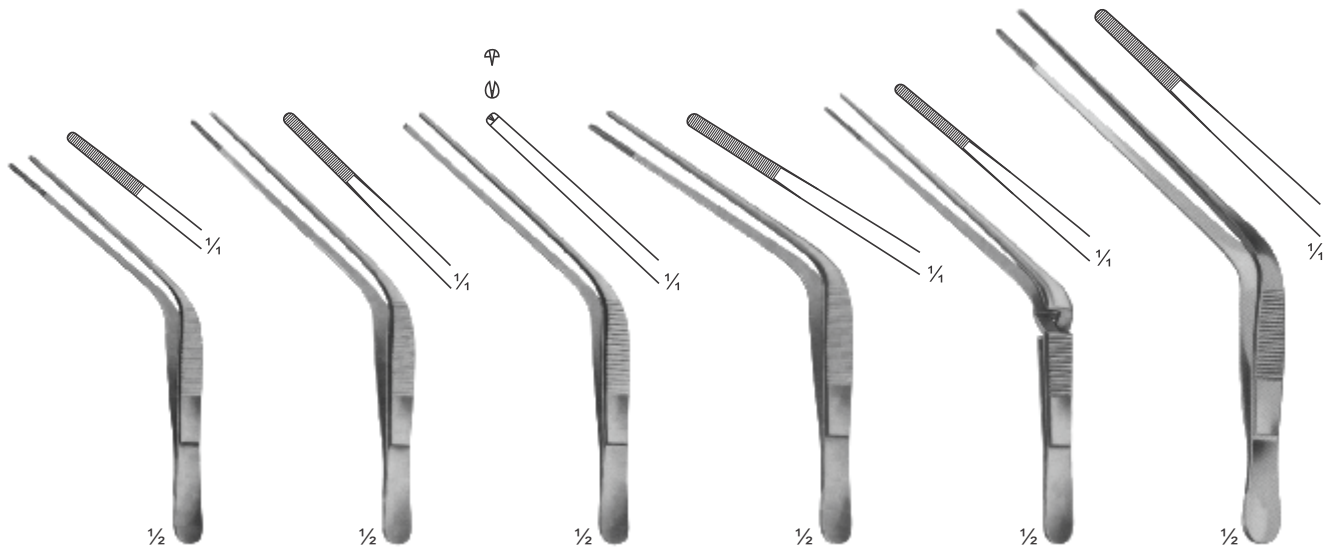

CM05-173
TROELTSCH
100 mm

CM05-174
TROELTSCH
115 mm

CM05-175
TROELTSCH
1X2 teeth
115 mm

CM05-176
WILDE
115 mm

CM05-177
TROELTSCH
Cross action
120 mm

CM05-178
TROELTSCH
140 mm

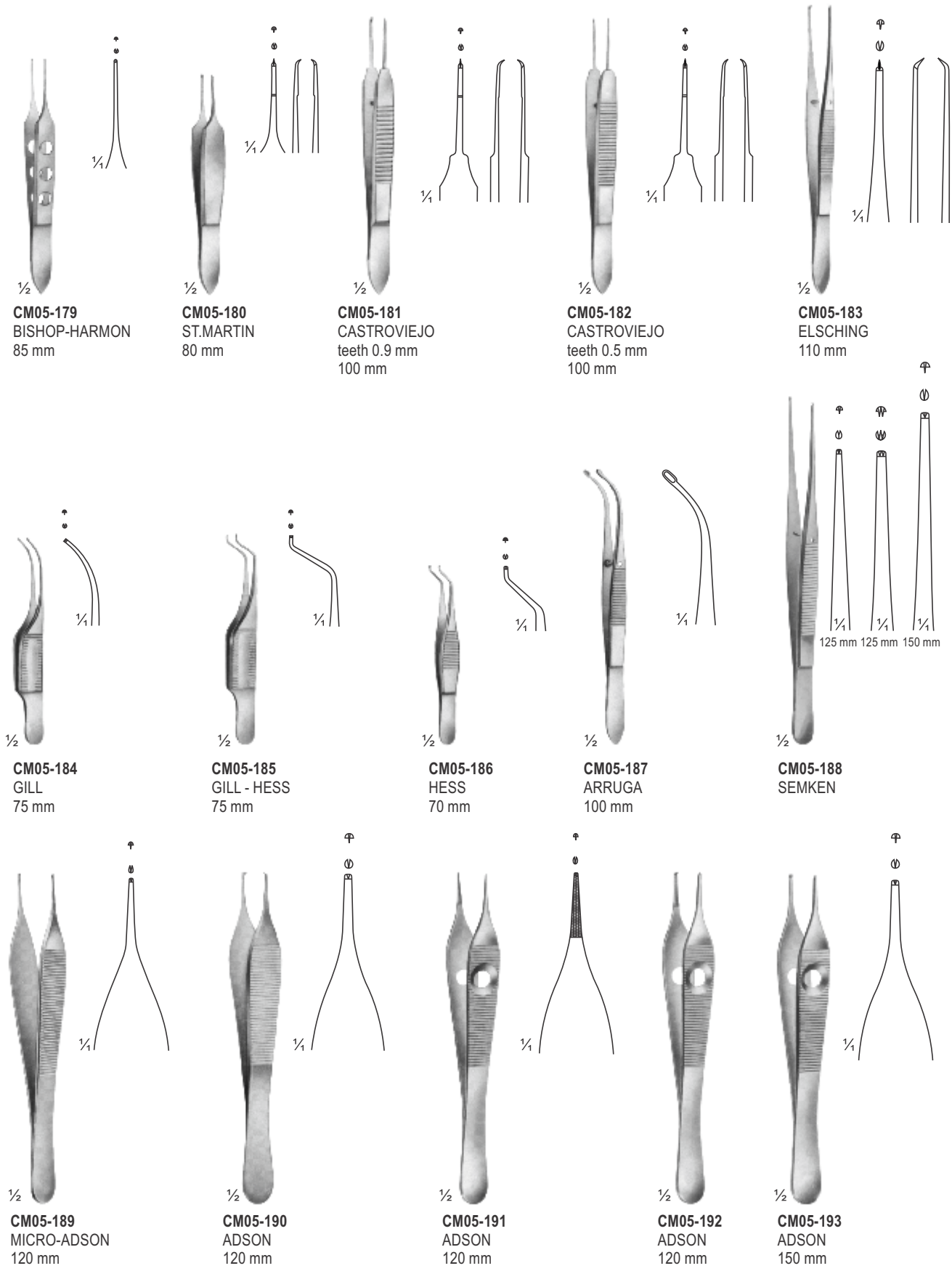

CM05-179
BISHOP-HARMON
85 mm

CM05-180
ST.MARTIN
80 mm

CM05-181
CASTROVIEJO
teeth 0.9 mm
100 mm

CM05-182
CASTROVIEJO
teeth 0.5 mm
100 mm

CM05-183
ELSCHING
110 mm

CM05-184
GILL
75 mm

CM05-185
GILL - HESS
75 mm

CM05-186
HESS
70 mm

CM05-187
ARRUGA
100 mm

CM05-188
SEMKEN

CM05-189
MICRO-ADSON
120 mm

CM05-190
ADSON
120 mm

CM05-191
ADSON
120 mm

CM05-192
ADSON
120 mm

CM05-193
ADSON
150 mm

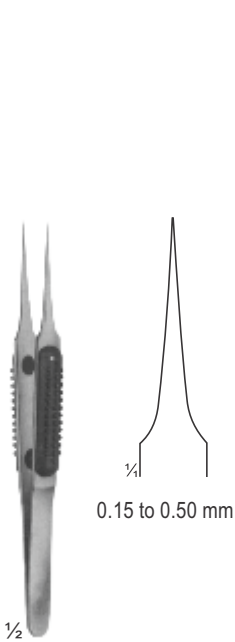

MULLER
CM05-194
110 mm 0.15 mm
CM05-195
110 mm 0.20 mm
CM05-196
110 mm 0.30 mm
CM05-197
110 mm 0.50 mm
CM05-198

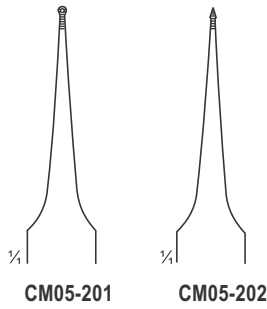

MULLER
CM05-199
110 mm
CM05-200
110 mm

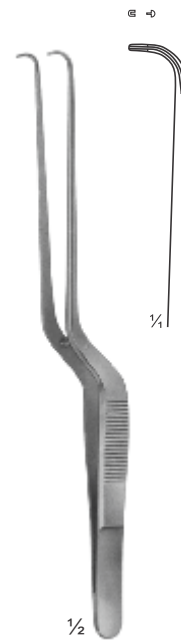

YASARGIL
CM05-203
185 mm



YASARGIL
CM05-204
180 mm
CM05-205
200 mm
CM05-206
220 mm
CM05-207
240 mm

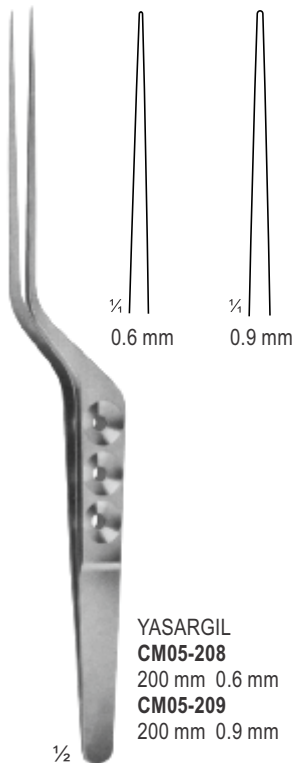

YASARGIL
CM05-208
200 mm 0.6 mm
CM05-209
200 mm 0.9 mm

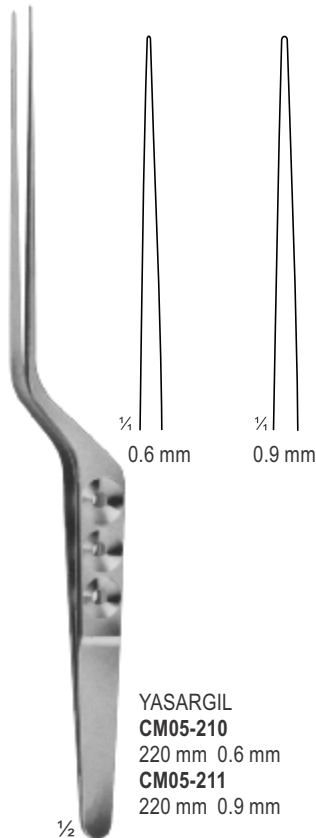

YASARGIL
CM05-210
220 mm 0.6 mm
CM05-211
220 mm 0.9 mm

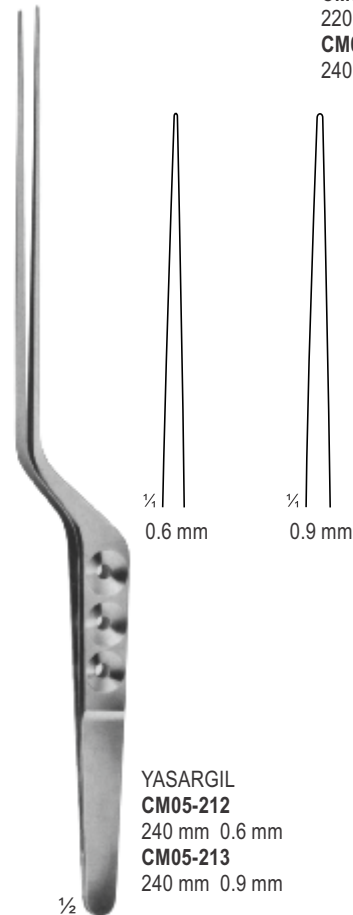

YASARGIL
CM05-212
240 mm 0.6 mm
CM05-213
240 mm 0.9 mm

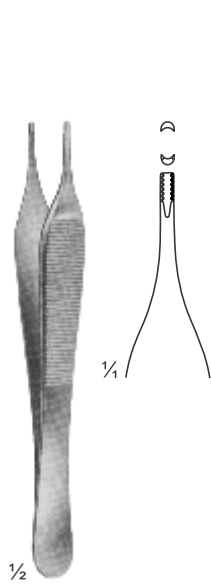

CM05-214
ADSON - BROWN
 Non-traumatic
 120 mm

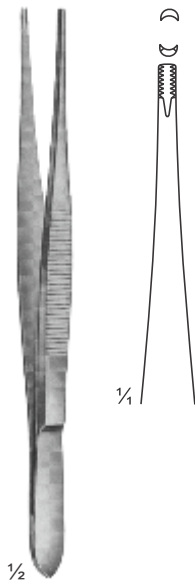

CM05-215
BROWN
 120 mm

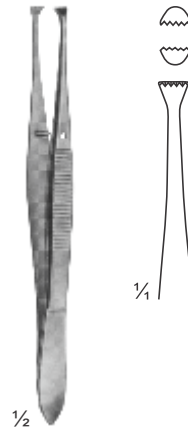

CM05-216
GRAEFE
 110 mm

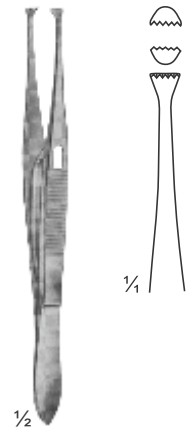

CM05-217
GRAEFE
 With Catch
 110 mm

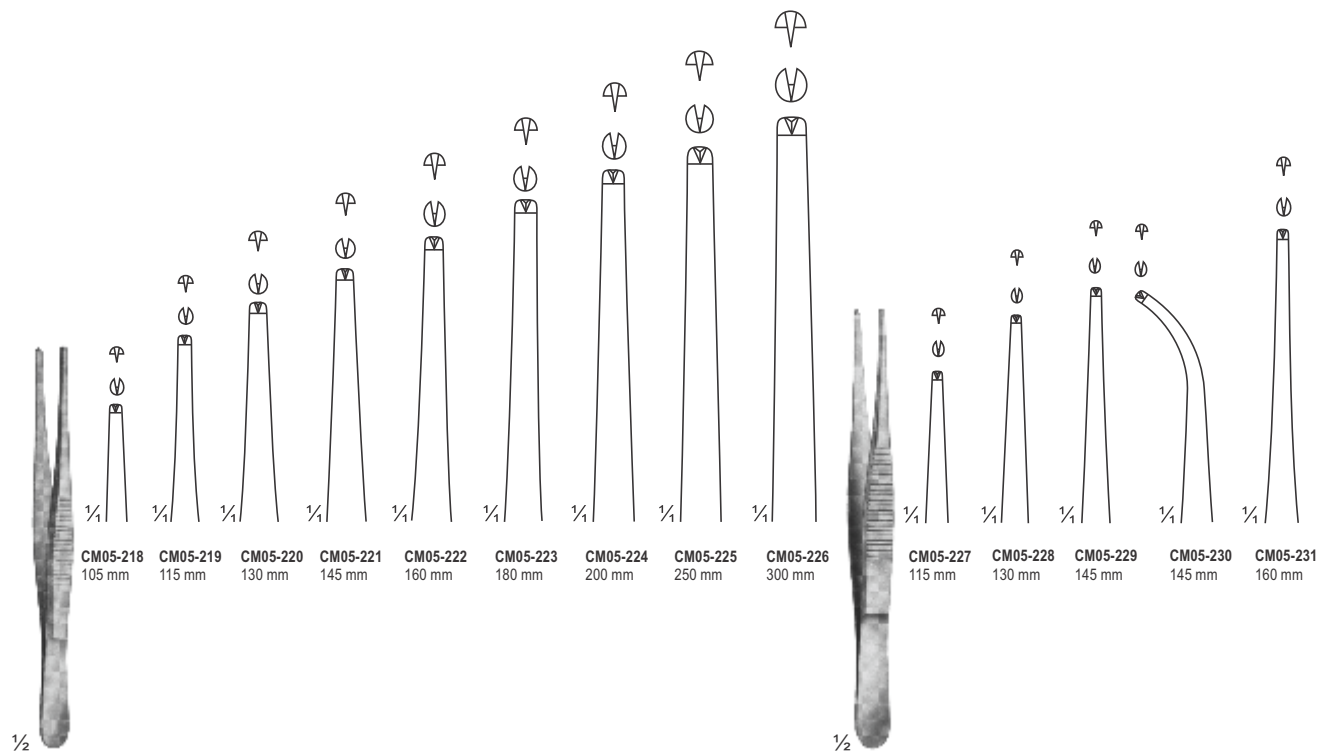

CM05-218 - CM05-226
STANDARD

CM05-227 - CM05-231
GRAEFE
 110 mm

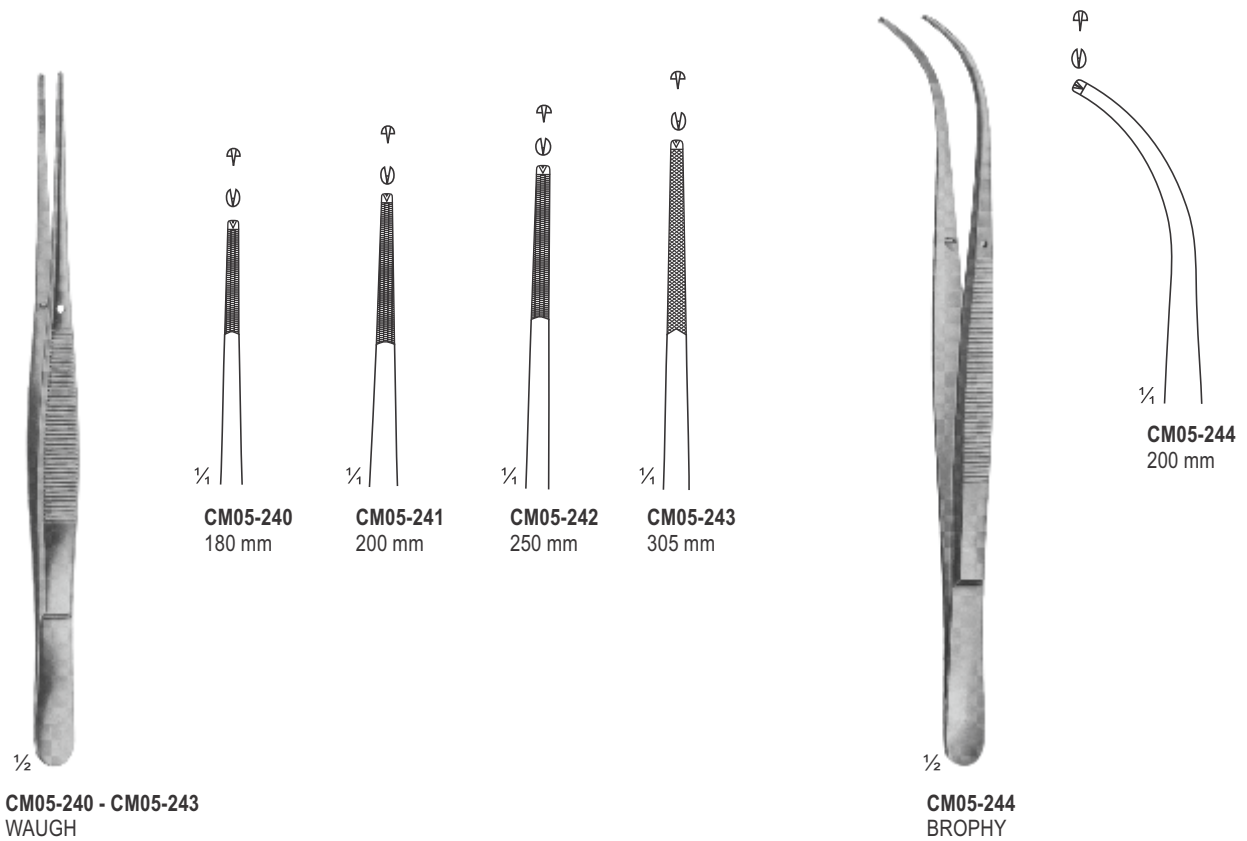
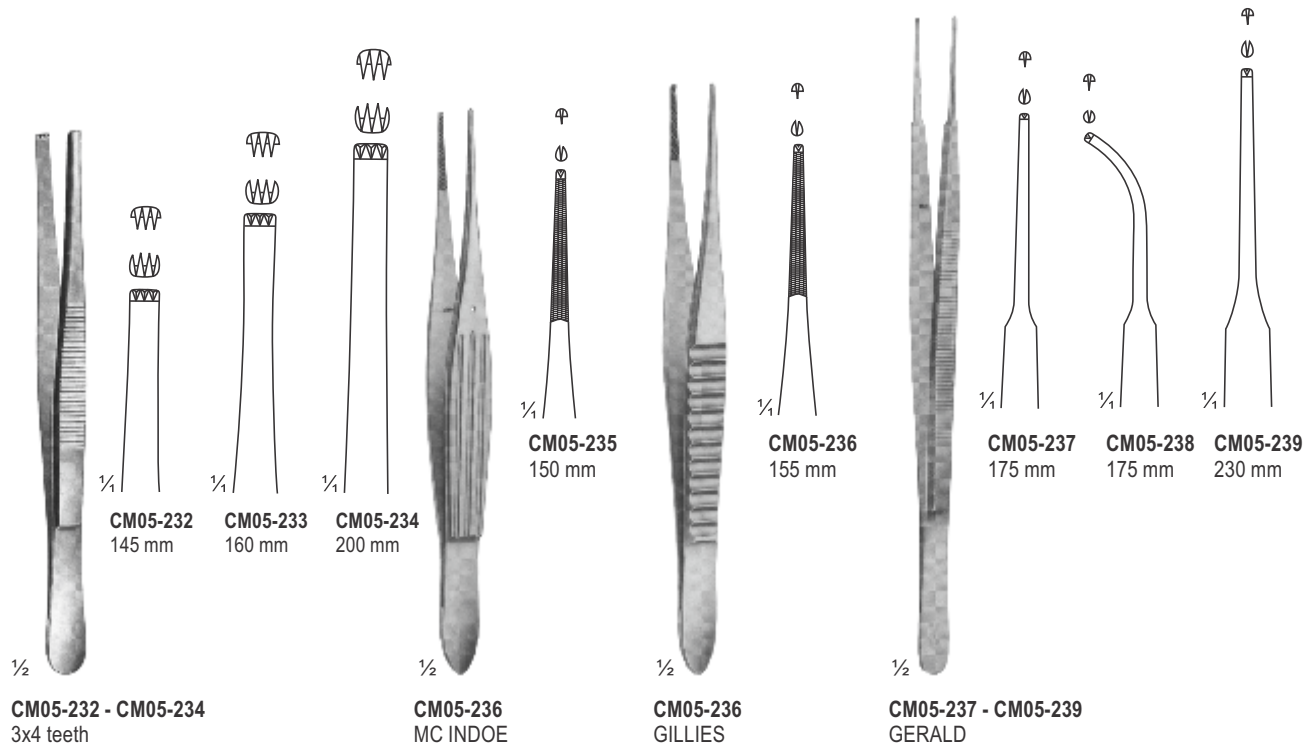

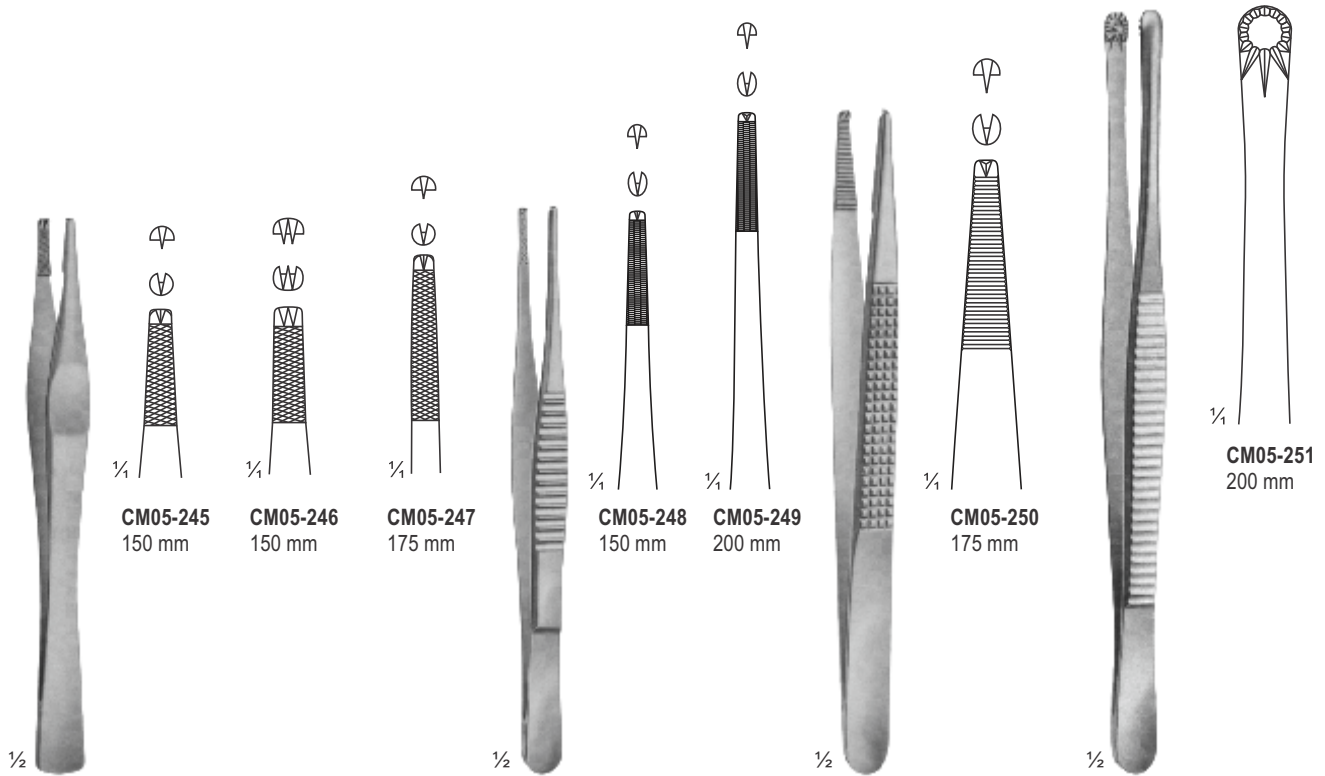

CM05-245 - CM05-247
LANE

CM05-248 - CM05-249
STRASSBURGER
MODELL

CM05-250
BONNEY

CM05-251
RUSS. MODELL
200 mm

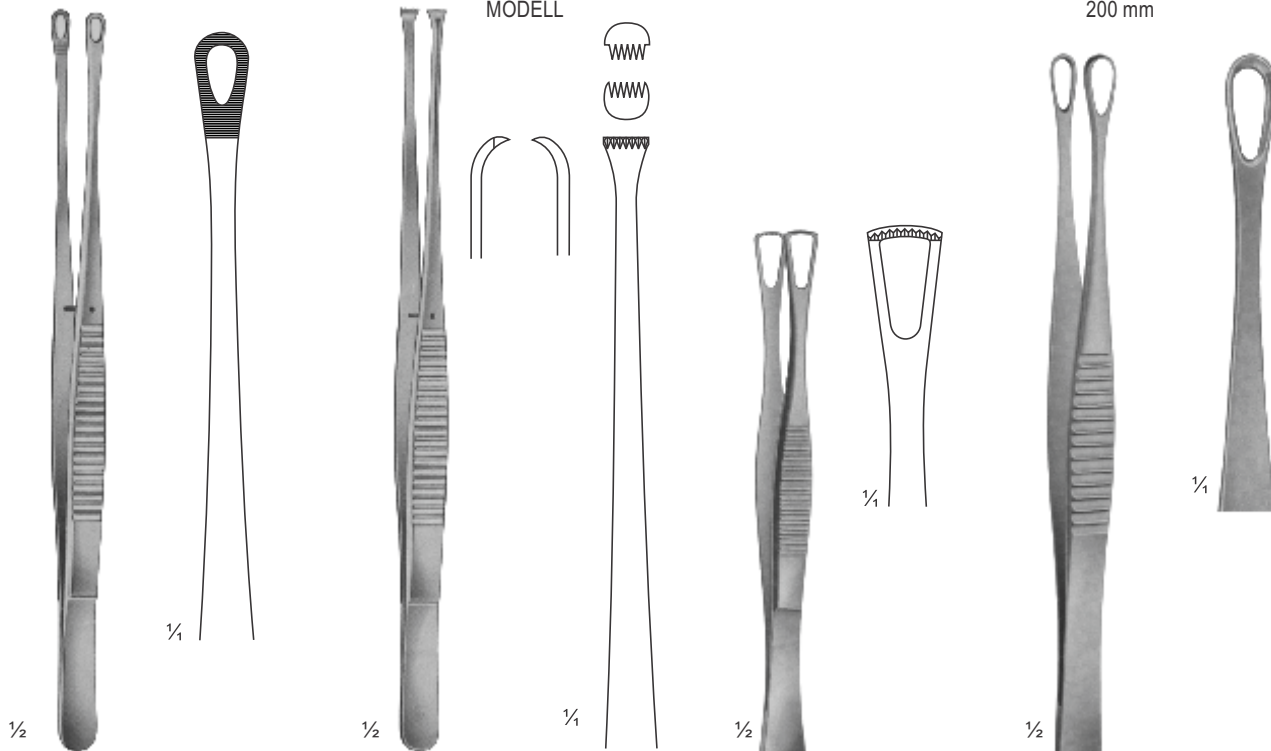

CM05-252
TUTTLE
Lung Dissecting Forceps
230 mm

CM05-253
NELSON
Lung Dissecting Forceps
230 mm

CM05-254
DUVAL
Intestinal Forceps
140 mm

CM05-255
DENIS-BROWNE
Intestinal Forceps
190 mm

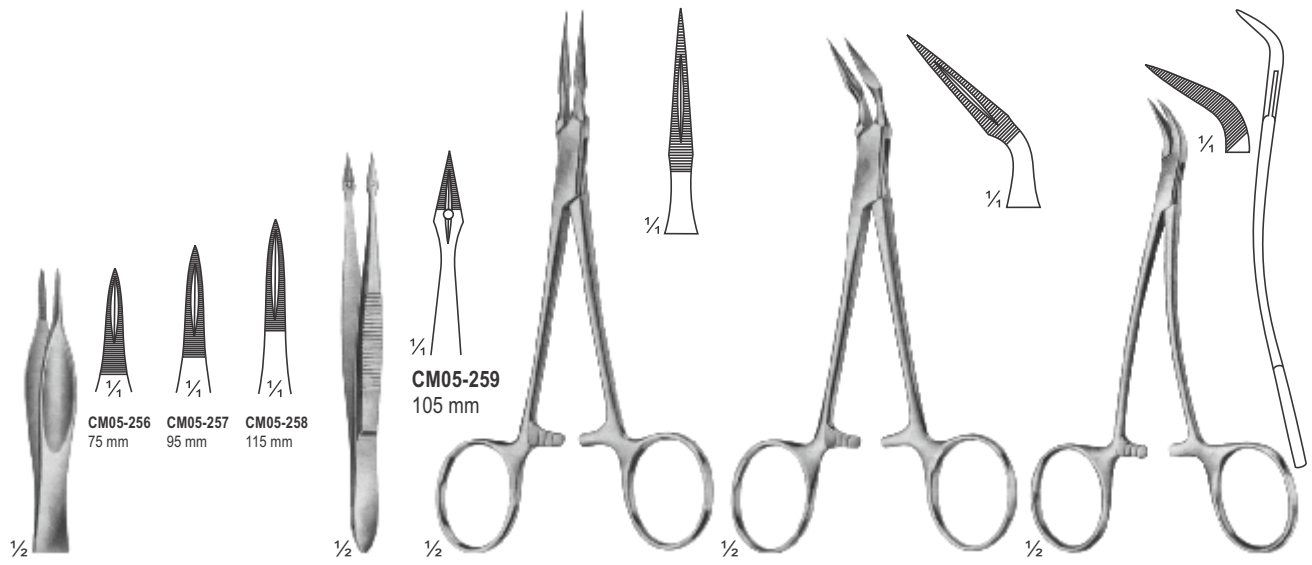

CM05-256 - CM05-258
FEILCHENFELD

CM05-259
HUNTER

CM05-260
STIEGLITZ
140 mm

CM05-261
STIEGLITZ
140 mm

CM05-262
PEET
120 mm

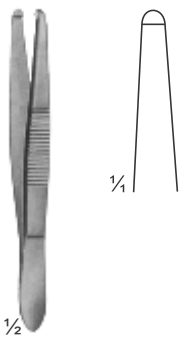

CM05-263
BEER
85 mm

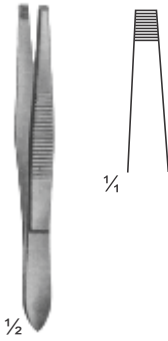

CM05-264
85 mm

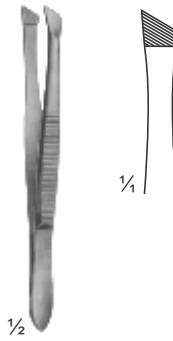

CM05-265
85 mm

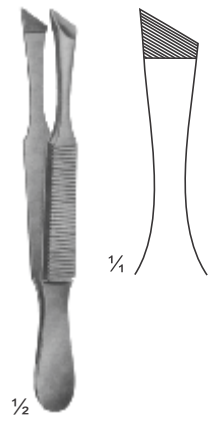

CM05-266
105 mm

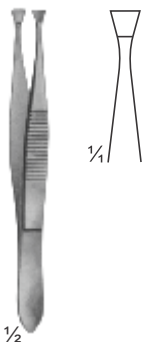

CM05-267
105 mm

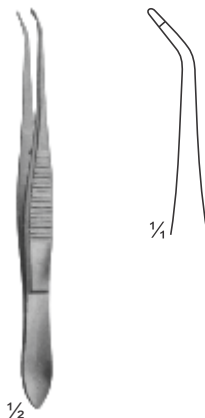

CM05-268
SAUPE
105 mm

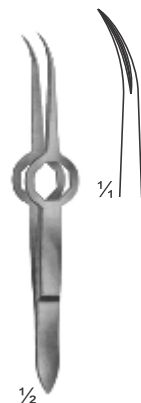

CM05-269
SCHAAF
95 mm

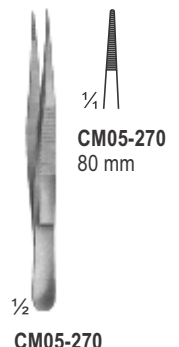

CM05-270

CM05-270
80 mm



STANDARD
CM05-271 14.5 cm, 5 3/4"
CM05-272 16.0 cm, 6 1/4"
CM05-273 18.0 cm, 7"
CM05-274 20.0 cm, 8"
CM05-275 25.0 cm, 10"
CM05-276 30.0 cm, 12"

STANDARD
CM05-277 14.5 cm, 5 3/4"
CM05-278 16.0 cm, 6 1/4"
CM05-279 18.0 cm, 7"
CM05-280 20.0 cm, 8"
CM05-281 25.0 cm, 10"
CM05-282 30.0 cm, 12"

STANDARD
CM05-283 12.5 cm, 5"
CM05-284 15.0 cm, 6"

STANDARD
CM05-285 15.0 cm, 6"
CM05-286 23.0 cm, 9"
CM05-287 25.0 cm, 10"



GILLIES
CM05-288
15.0 cm, 6"



MC INDOE
CM05-289
15.0 cm, 6"



GERALD
CM05-290 - CM05-291
17.0 cm, 6 3/4"



POTTS-SMITH
CM05-292 15.0 cm, 6"
CM05-293 18.0 cm, 7"
CM05-294 20.0 cm, 8"



BONNEY
CM05-295
17.5 cm, 6 5/8"



CUSHING
CM05-296 - CM05-297
17.5 cm, 6 5/8"



CUSHING-TAYLOR
CM05-298
18.0 cm, 7"



ADSON
CM05-299 - CM05-302
17.5 cm, 6 5/8"



DE BAKEY
CM05-303
 150 mm
CM05-304
 200 mm
CM05-305
 250 mm



DE BAKEY
CM05-306
 150 mm
CM05-307
 200 mm
CM05-308
 250 mm



JABOMA-TC
CM05-309
 180 mm



JABOMA-TC
CM05-310
 180 mm

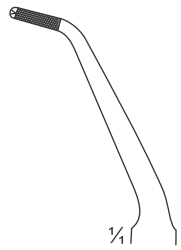

JABOMA-TC
CM05-311
 180 mm

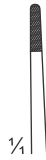

OBWEGESER
CM05-312
 160 mm



OBWEGESER
CM05-313
 180 mm



MERIEM
CM05-314



POTTS-NEVINS
CM05-315
 180 mm





CARE MEDICAL[®]
SUPPLIES

Your health _ Our Priority

Section

06

Page 87-115

Haemostatic, Special Pattern And Tonsil Forceps
DISSECTING- AND Ligature FORCEPS
Hysterectomy Forceps, Vaginal Clamps And Compression Forceps
Haemostatic, Special Pattearn And Tonsil Forceps
Hysterectomy Forceps And Vaginal Clamps

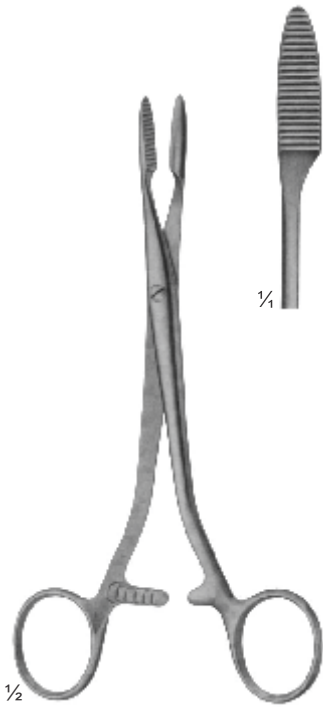

PEAN
CM06-001 16 cm
CM06-002 18 cm

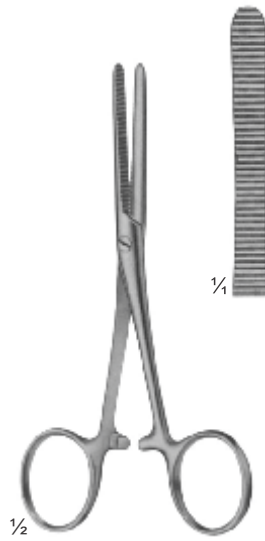

PEAN
CM06-003 12.5 cm

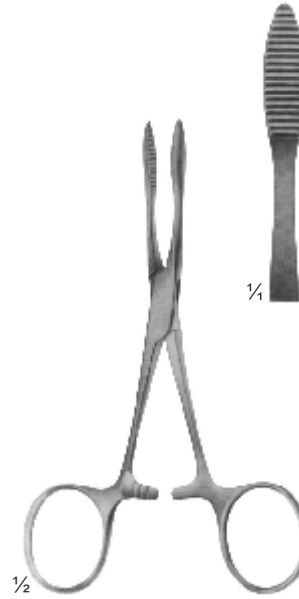

PEAN
CM06-004 12.5 cm
CM06-005 14 cm

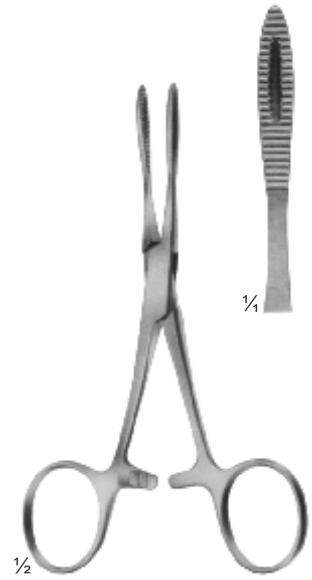

KRONLEIN
CM06-006 13 cm



SPENCER-WELLS
CM06-007 - CM06-013
CM06-007 13 cm
CM06-008 14 cm
CM06-009 15 cm
CM06-010 18 cm
CM06-011 20 cm
CM06-012 25 cm
CM06-013 30 cm

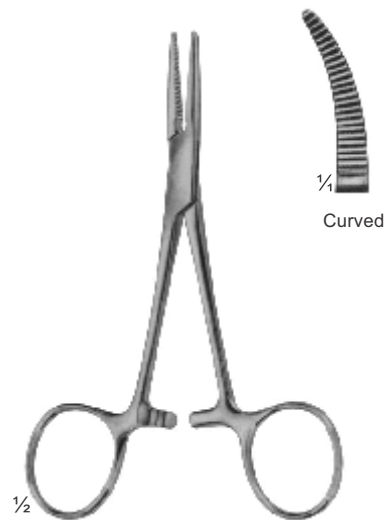

SPENCER-WELLS
CM06-014 - CM06-021
CM06-014 13 cm
CM06-015 14 cm
CM06-016 15 cm
CM06-017 18 cm
CM06-018 20 cm
CM06-019 25 cm
CM06-020 30 cm



CM06-021 -024
HALSTED-MOSQUITO
125 mm

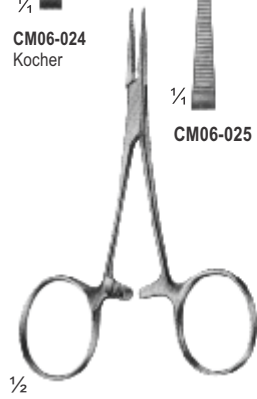
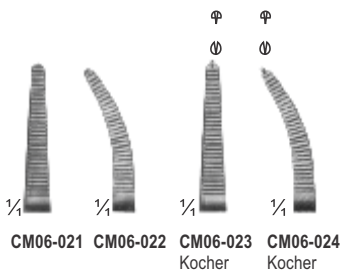

CM06-025 - 028
BABY-MOSQUITO
(HARTMANN)
100 mm

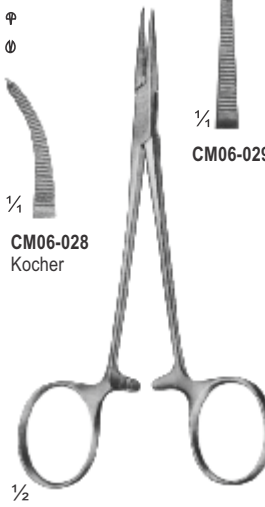
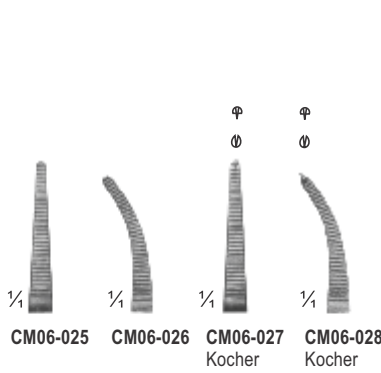

CM06-029 - 032
MICRO-HALSTED
125 mm

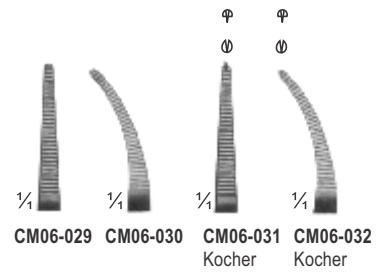

CM06-033 - 034
PROVIDENCE-HOSPITAL
140 mm

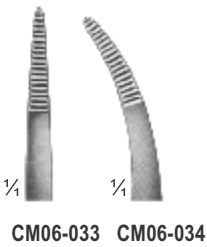

CM06-035 - 036
KELLY
140 mm

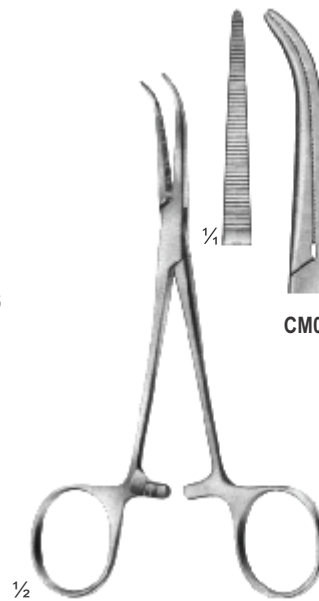
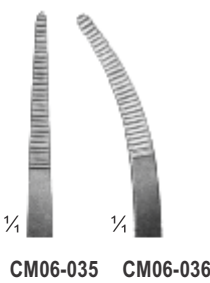

CM06-037 - 038
DANDY
Curved sideways
140 mm



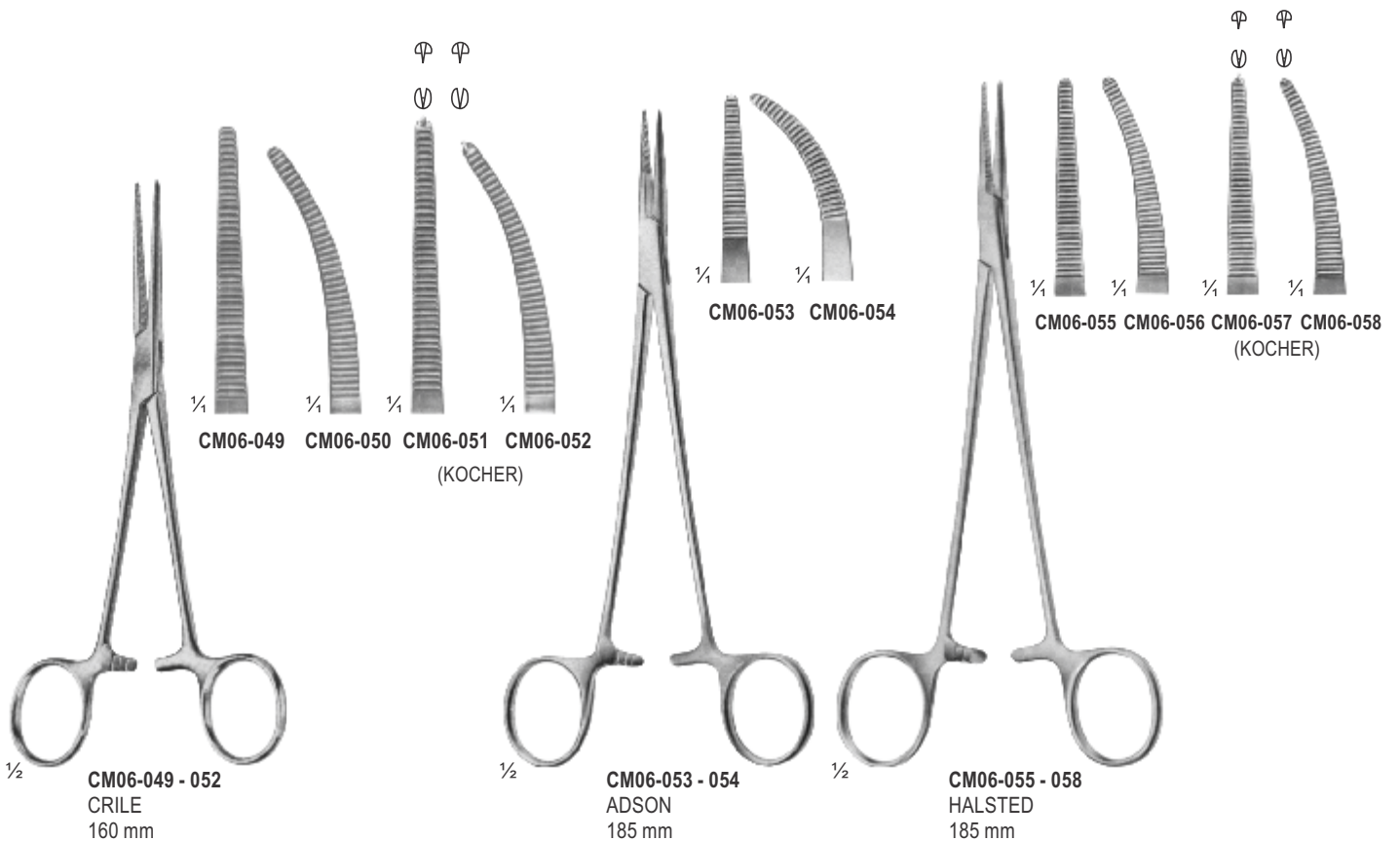
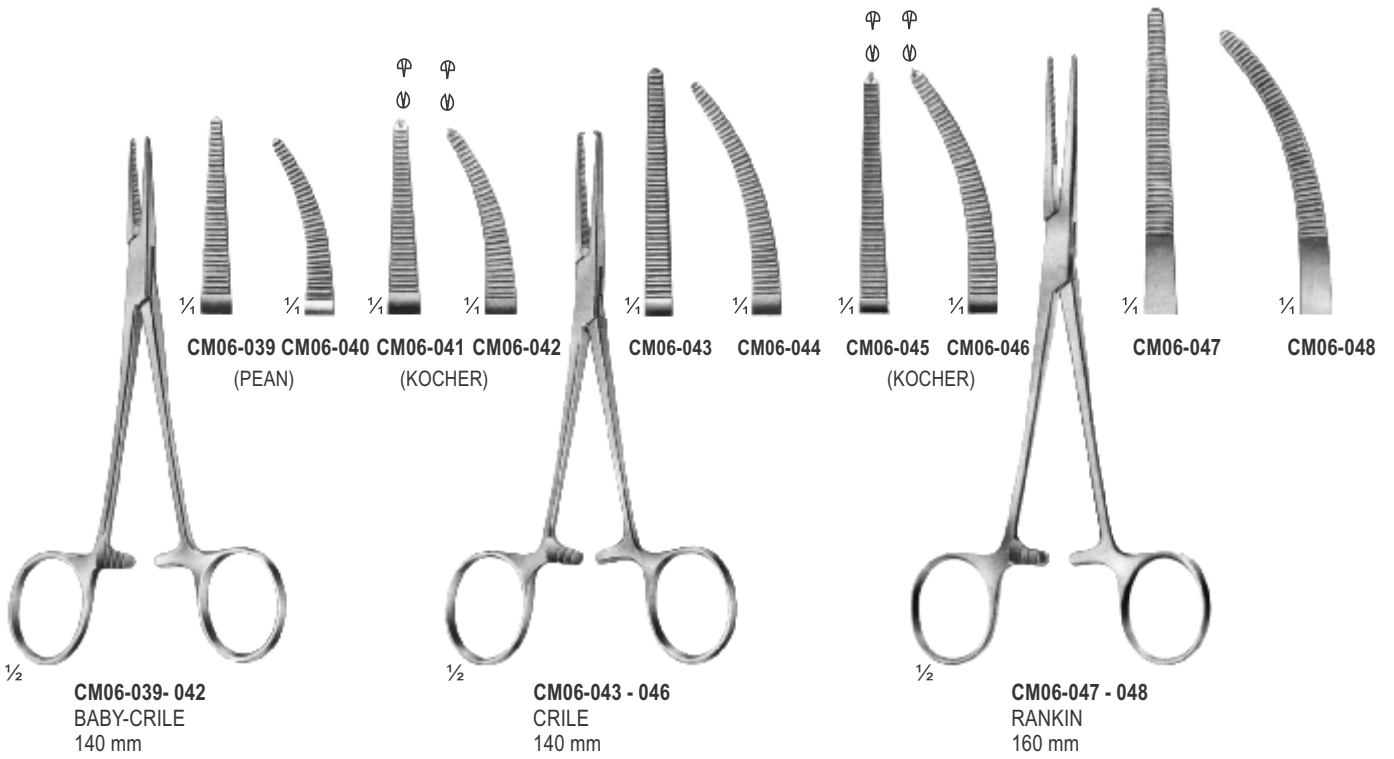

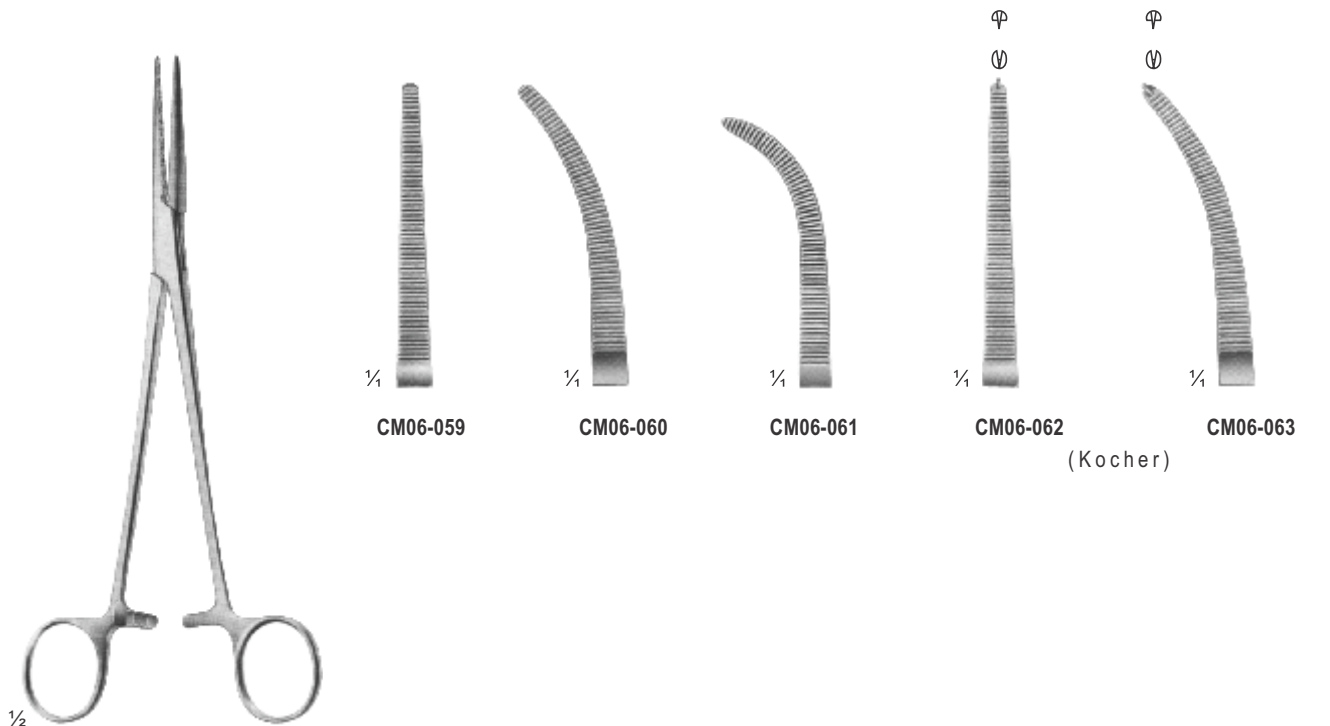

CM06-059 - 063
HEISS
200 mm



CM06-064 - 065
HALSTED
215 mm

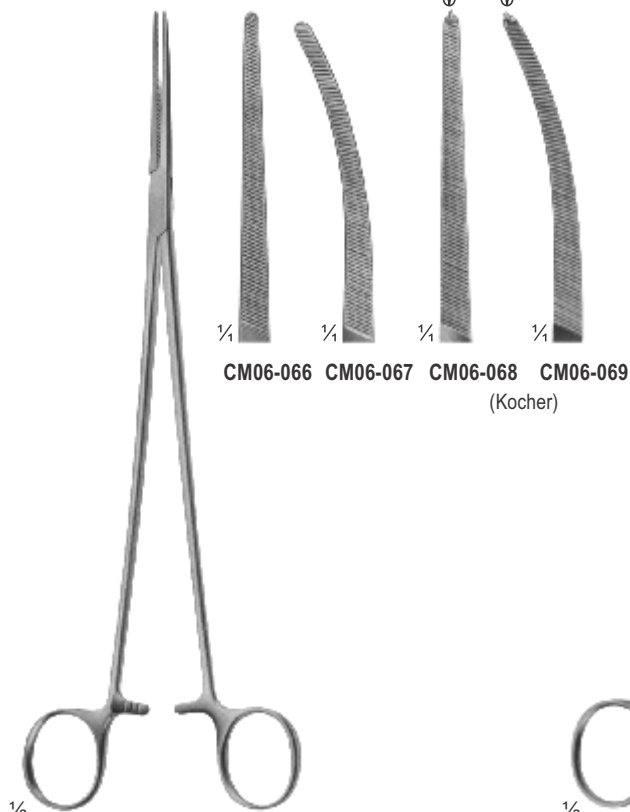

CM06-066 - 069
BENGOLEA
245 mm

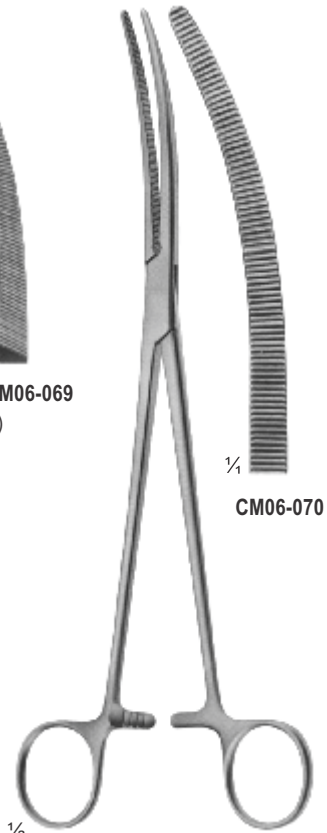

CM06-070
CRAFOORD
245 mm



CM06-071 CM06-072

HALSTED-MOSQUITO
CM06-071 180 mm
CM06-072 210 mm

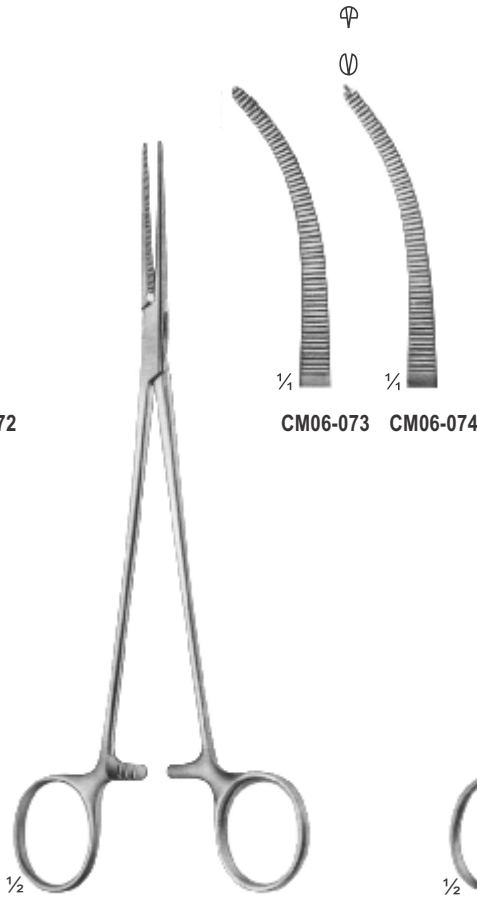

CM06-073 CM06-074

HALSTED-MOSQUITO
CM06-073 180 mm
CM06-074 210 mm

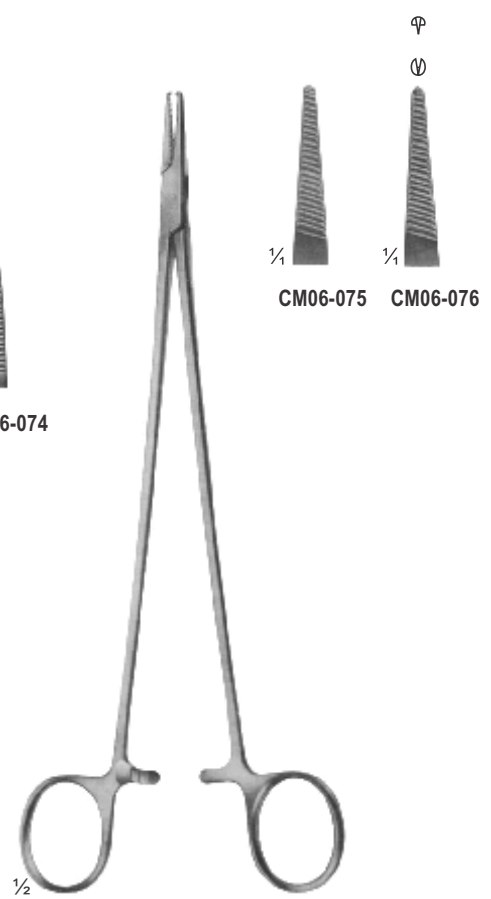

CM06-075 CM06-076

HALSTED
CM06-075 - 076
215 mm



MARTIN-FUCHSIG
CM06-077
200 mm

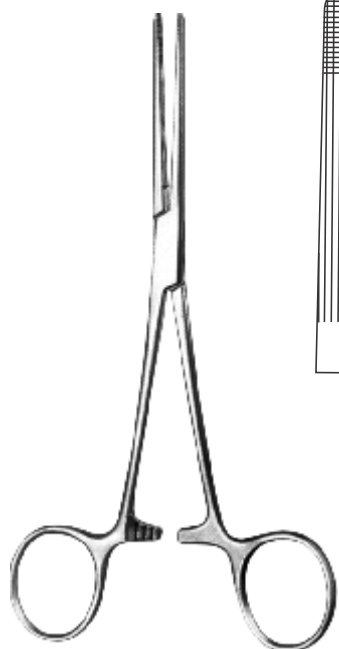

ROCHESTER-CARMALT
CM06-078 170 mm
CM06-079 200 mm

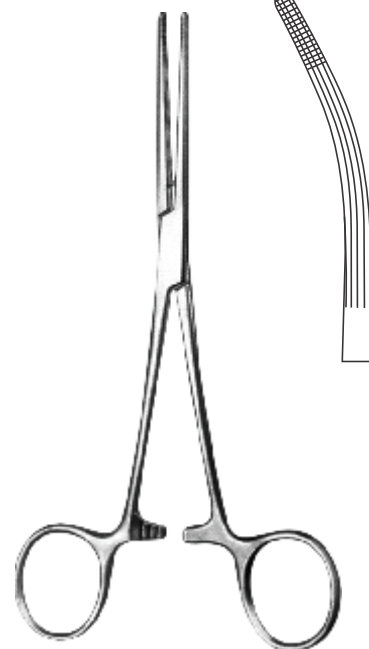

ROCHESTER-CARMALT
CM06-080 160 mm
CM06-081 200 mm



SPENCER-WELLS
CM06-082 - CM06-088
 CM06-082 13 cm
 CM06-083 14 cm
 CM06-084 15 cm
 CM06-085 18 cm
 CM06-086 20 cm
 CM06-087 25 cm
 CM06-088 30 cm

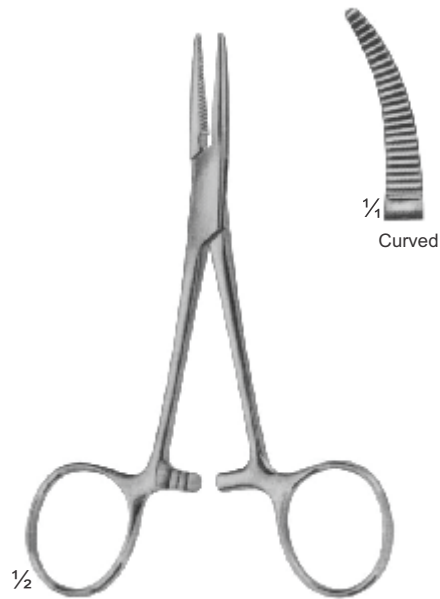

SPENCER-WELLS
04-157-13 - 04-163-30
 04-157-13 13 cm
 04-158-14 14 cm
 04-159-15 15 cm
 04-160-18 18 cm
 04-161-20 20 cm
 04-162-25 25 cm
 04-163-30 30 cm

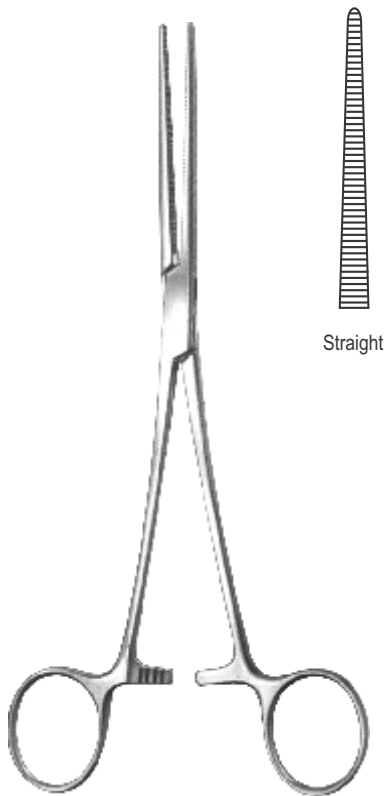

PEAN (ROCHESTER)
CM06-089 - CM06-096
 CM06-089 14 cm
 CM06-090 16 cm
 CM06-091 18 cm
 CM06-092 20 cm
 CM06-093 22 cm
 CM06-094 24 cm
 CM06-095 26 cm
 CM06-096 30 cm

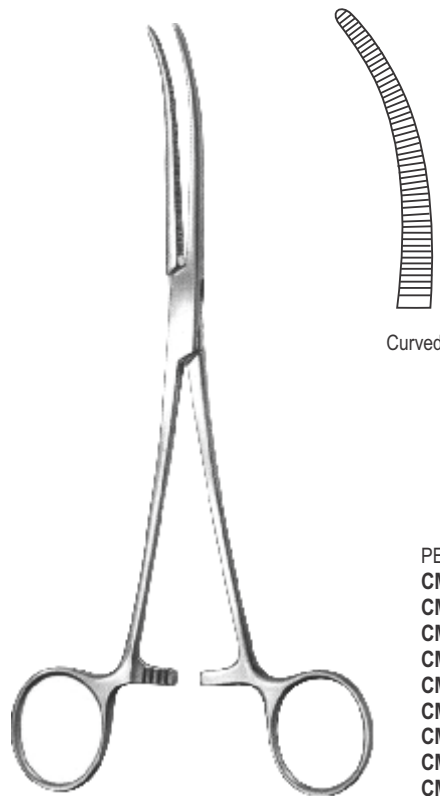

PEAN (ROCHESTER)
CM06-097 - CM06-104
 CM06-097 14 cm
 CM06-098 16 cm
 CM06-099 18 cm
 CM06-100 20 cm
 CM06-101 22 cm
 CM06-102 24 cm
 CM06-103 26 cm
 CM06-104 30 cm

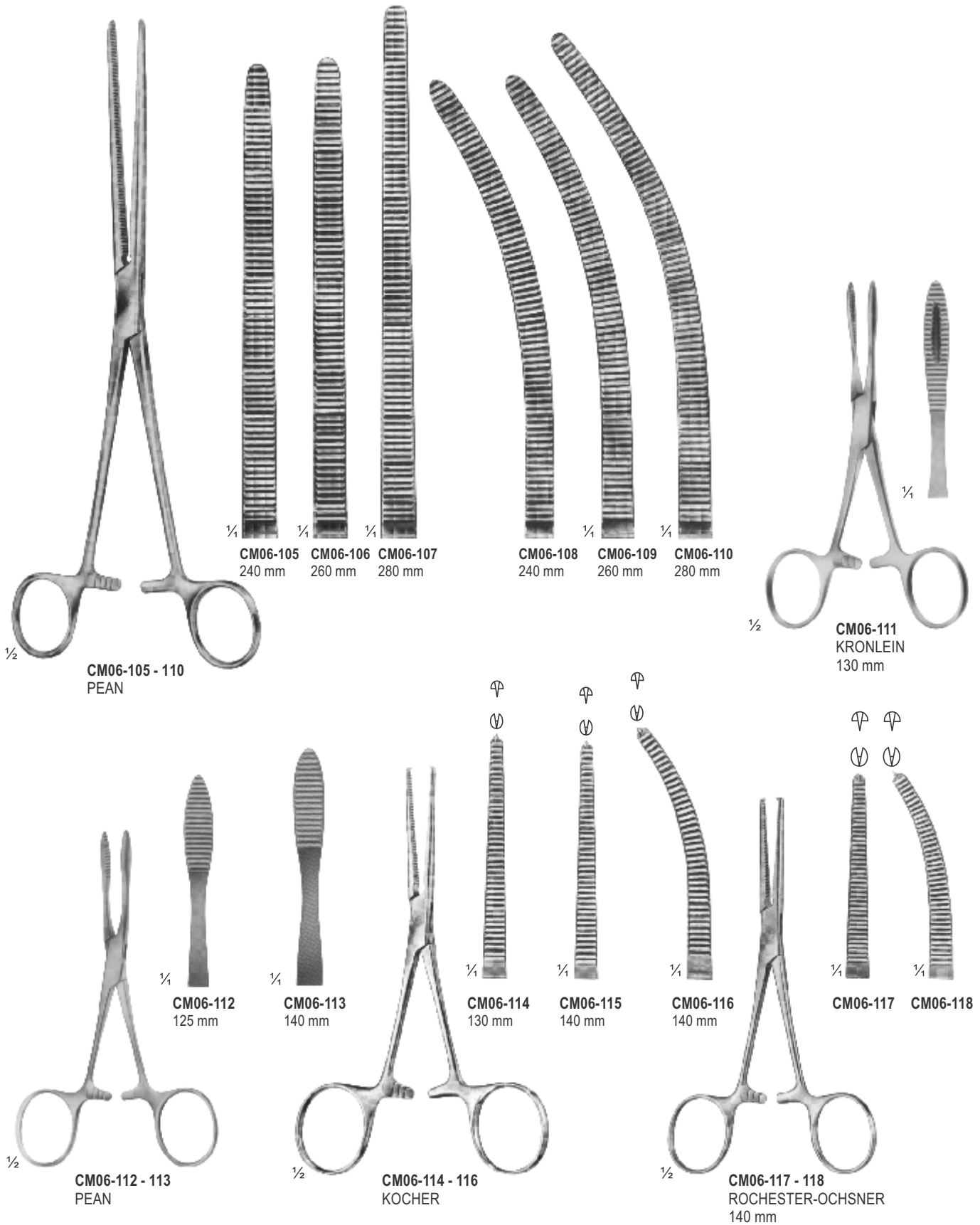



1/2
CM06-119 - CM06-123
KOCHER-OCHSNER (STR)

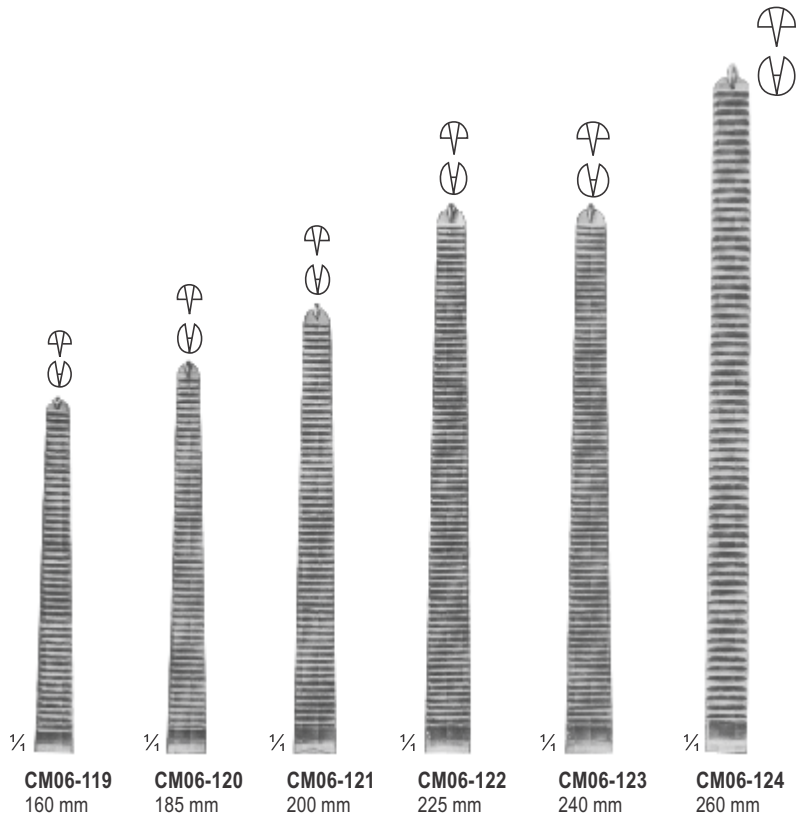

1/4 1/4 1/4 1/4 1/4 1/4
CM06-119 **CM06-120** **CM06-121** **CM06-122** **CM06-123** **CM06-124**
160 mm 185 mm 200 mm 225 mm 240 mm 260 mm



1/2
CM06-125 - 130
KOCHER-OCHSNER (CVD)

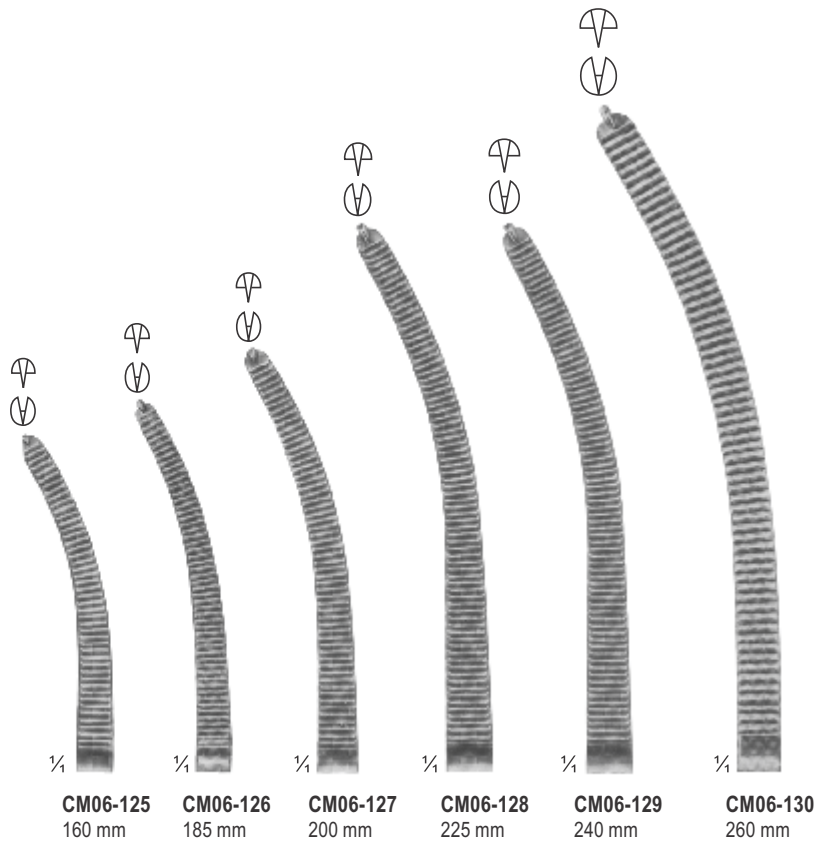

1/4 1/4 1/4 1/4 1/4 1/4
CM06-125 **CM06-126** **CM06-127** **CM06-128** **CM06-129** **CM06-130**
160 mm 185 mm 200 mm 225 mm 240 mm 260 mm

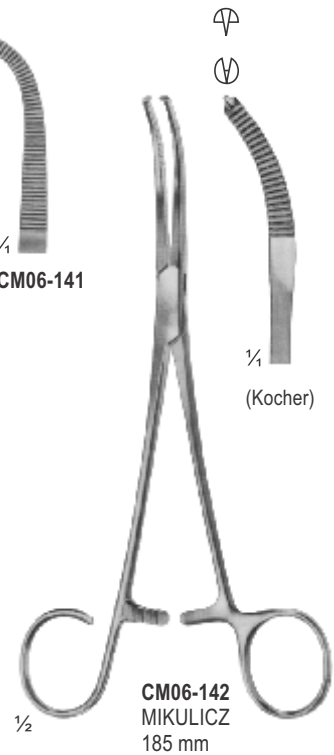
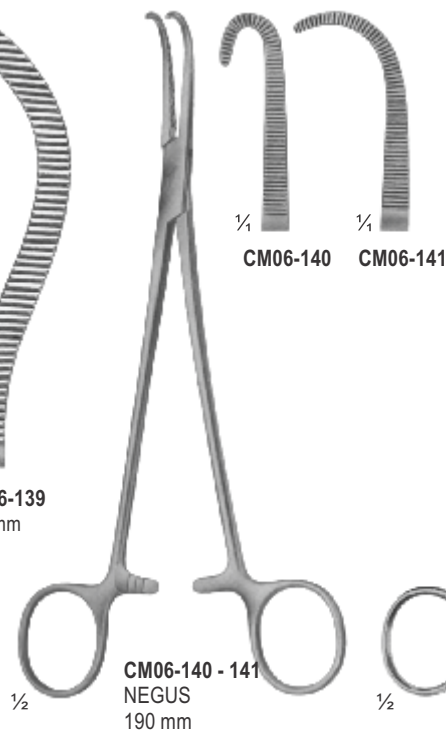
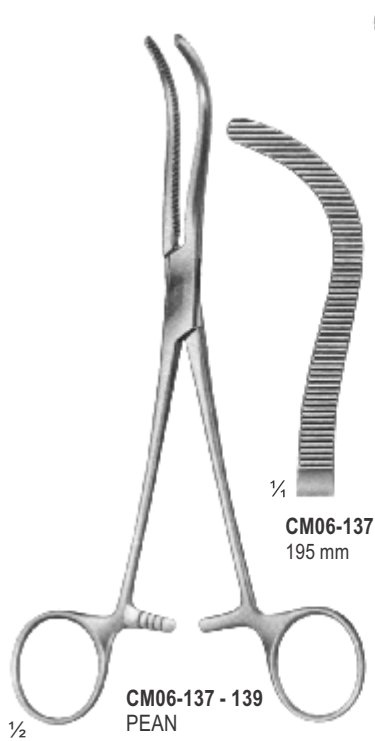
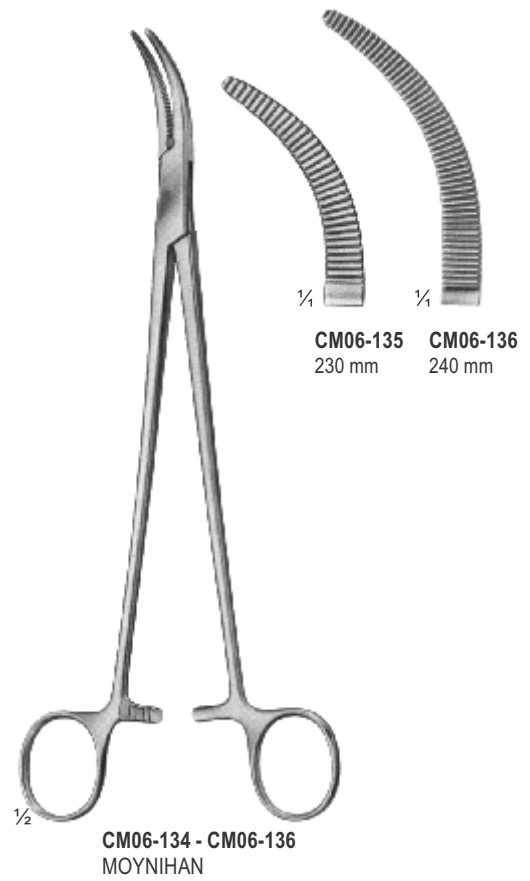
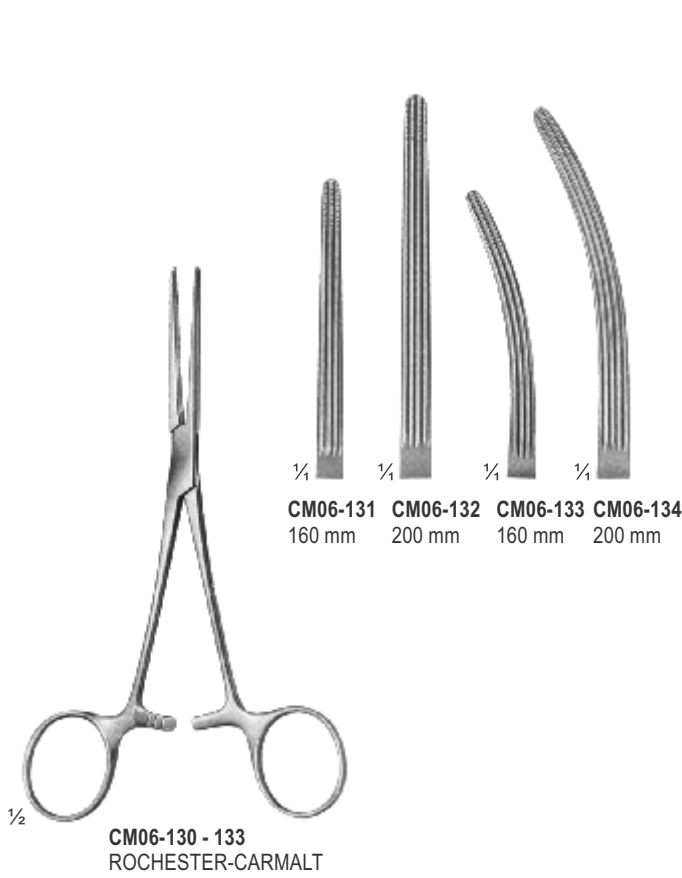

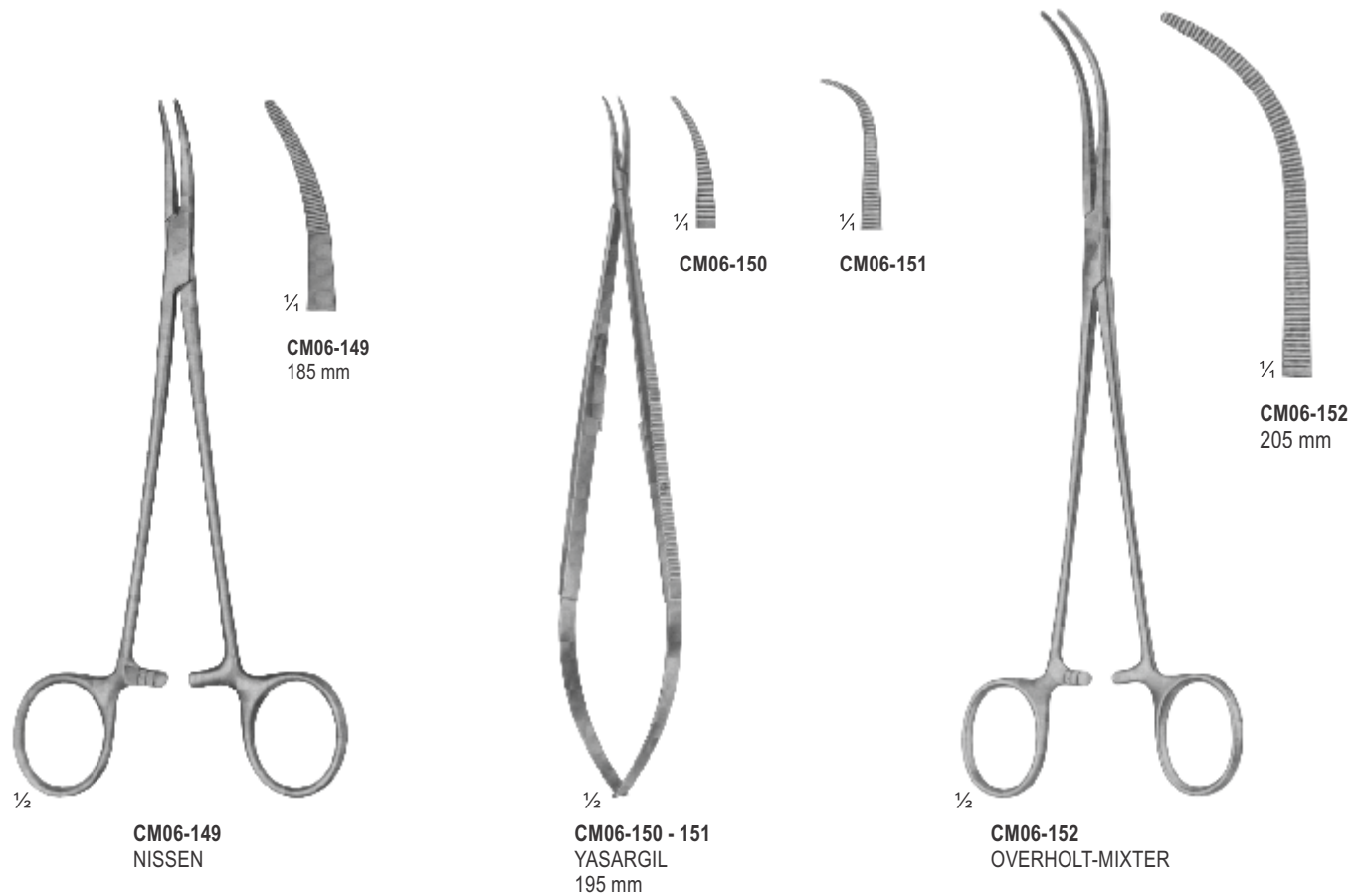
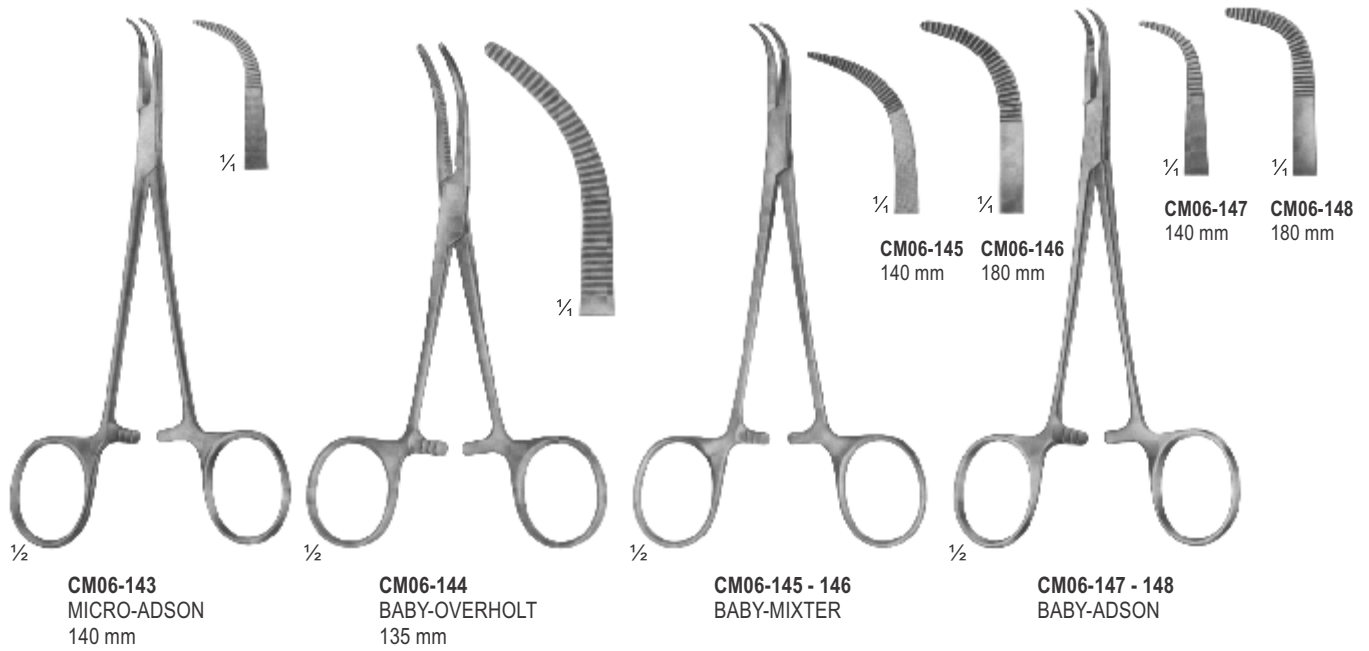



$\frac{1}{2}$
CRAFOORD
CM06-153 - 154

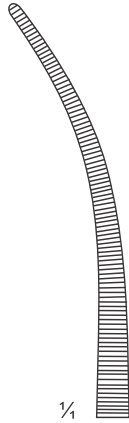

$\frac{1}{4}$
CM06-153
180 mm

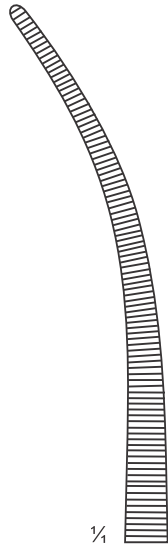

$\frac{1}{4}$
CM06-154
240 mm



$\frac{1}{2}$
CRAFOORD-SELLORS
CM06-155 - 157
240 mm

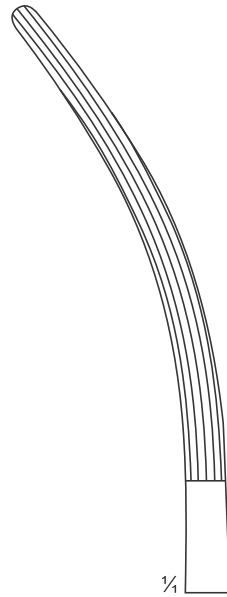

$\frac{1}{4}$
CM06-155

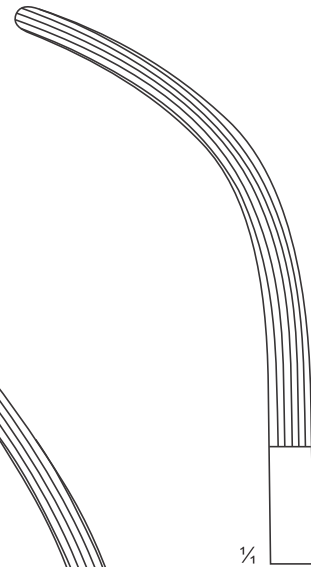

$\frac{1}{4}$
CM06-156

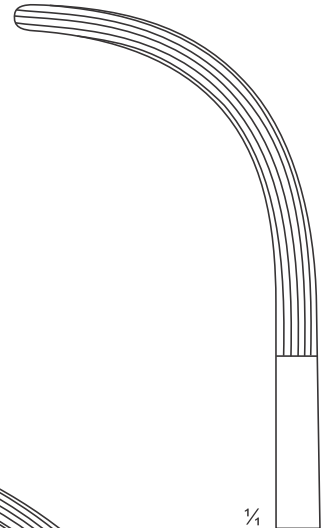

$\frac{1}{4}$
CM06-157

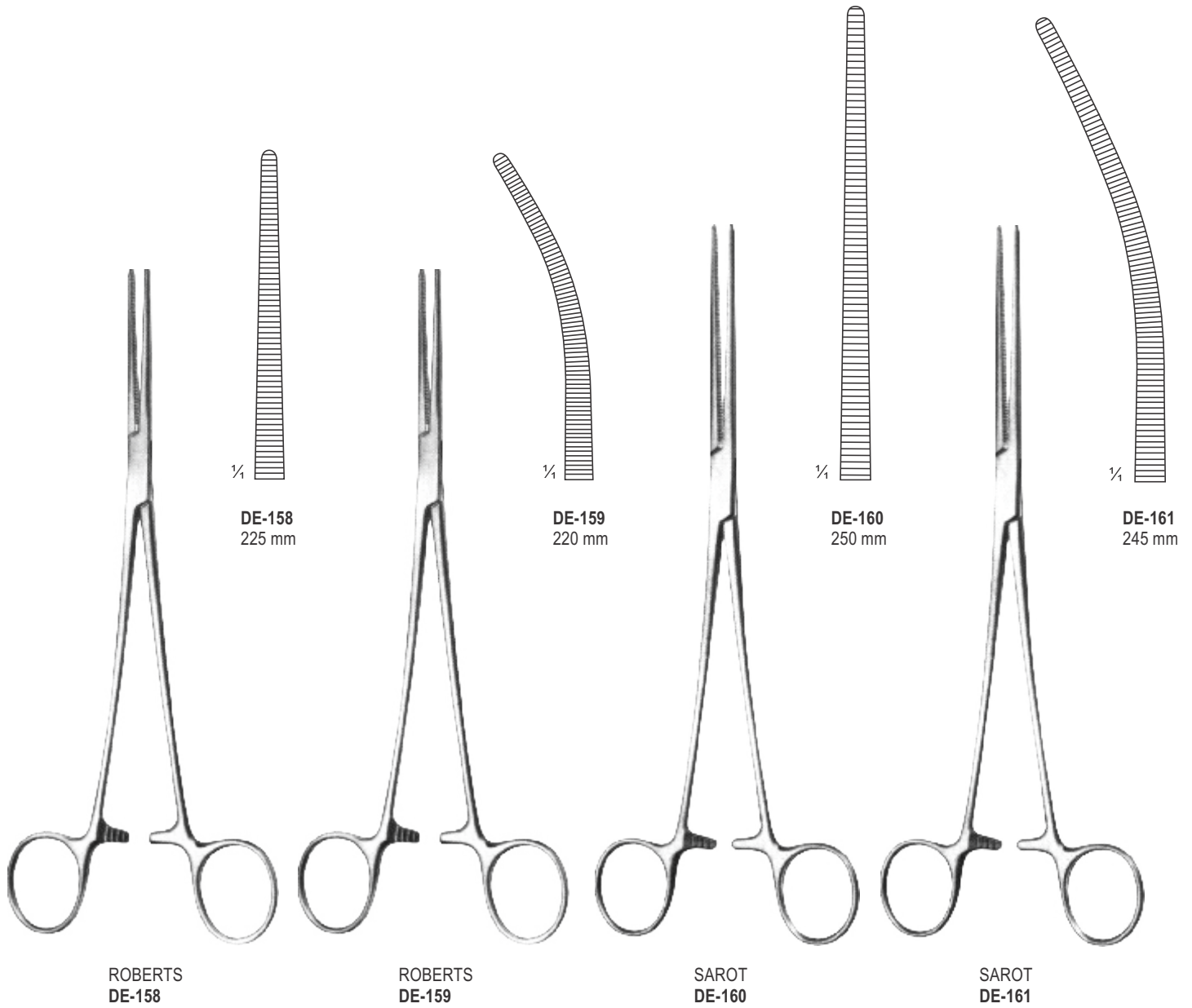

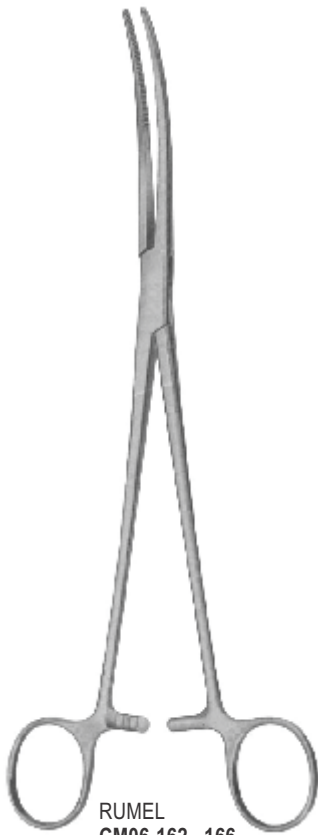

RUMEL
CM06-162 - 166
240 mm



CM06-162



CM06-163



CM06-164



CM06-165



CM06-166

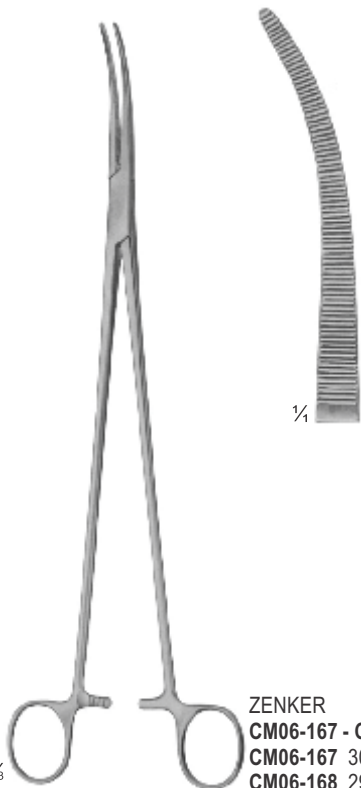

ZENKER
CM06-167 - CM06-168
CM06-167 300 mm
CM06-168 290 mm



1/4



LAWRENCE
CM06-169
270 mm



1/4



NEGUS
CM06-170 - 171
190 mm



1/4

CM06-170



1/4

CM06-171

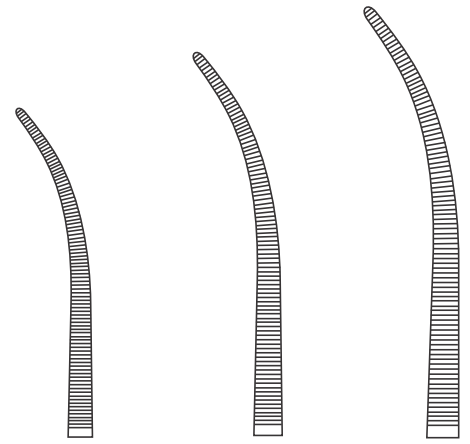

Fig. 1
CM06-173
190 mm

Fig. 1
CM06-174
225 mm

Fig. 1
CM06-175
240 mm

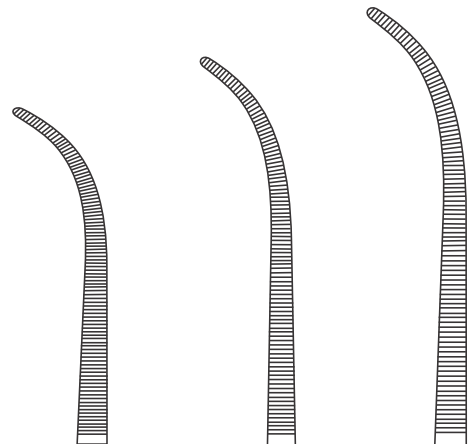

Fig. 2
CM06-176
190 mm

Fig. 2
CM06-177
220 mm

Fig. 2
CM06-178
235 mm

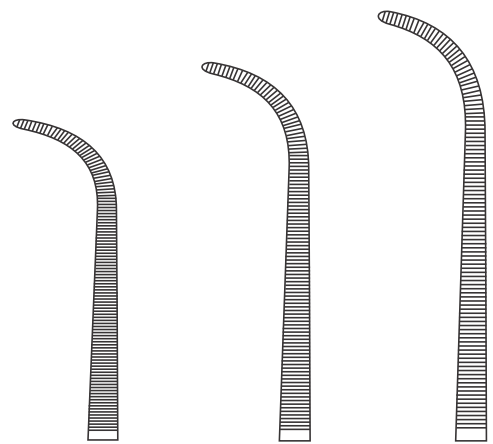

Fig. 3
CM06-179
185 mm

Fig. 3
CM06-180
215 mm

Fig. 3
CM06-181
235 mm



$\frac{1}{2}$
CM06-181 - 193
OVERHOLT-GEISSENDOERFER

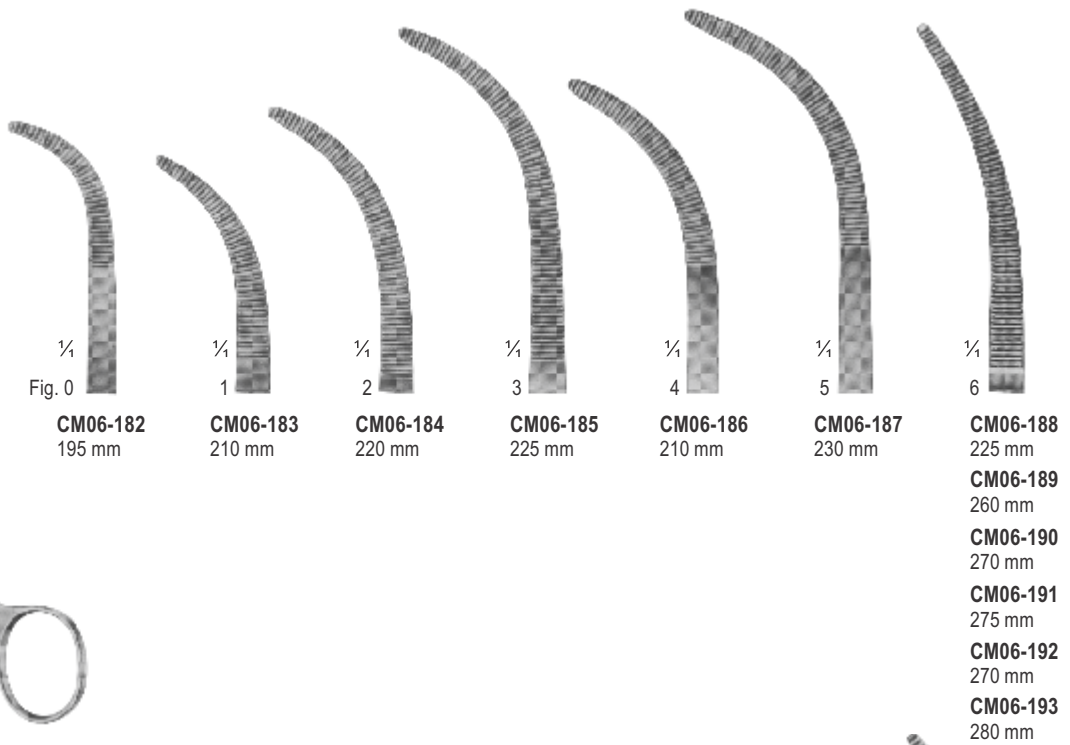

$\frac{1}{2}$
CM06-194 - 201
OVERHOLT
fine pattern

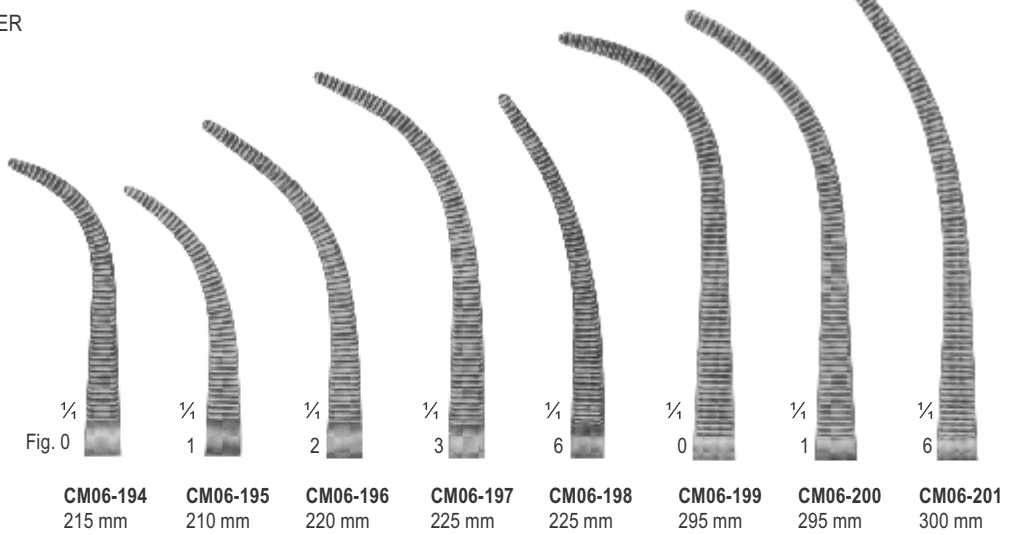



MINI-GEMINI
CM06-202 - 205

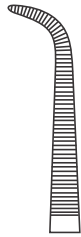

CM06-202
180 mm

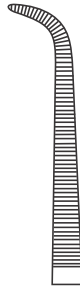

CM06-203
230 mm

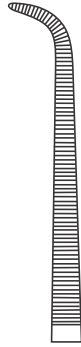

CM06-204
250 mm

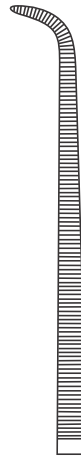

CM06-205
280 mm



OVERHOLT-MINI
CM06-206
200 mm



GEMINI
CM06-207 - CM06-213

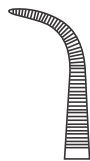

CM06-207
130 mm

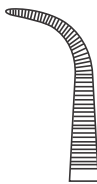

CM06-208
160 mm

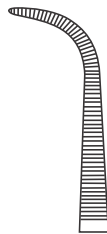

CM06-209
180 mm

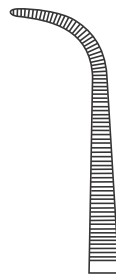

CM06-210
210 mm

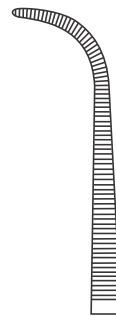

CM06-211
230 mm

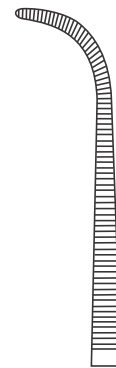

CM06-212
250 mm

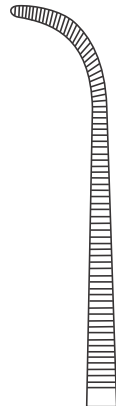

CM06-213
280 mm

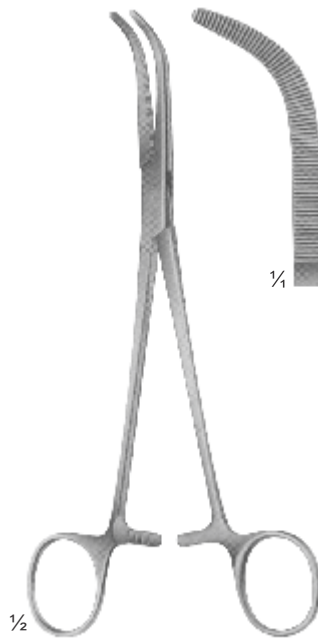

CM06-214
MIXTER-O'SHAUGHNESSY
190 mm

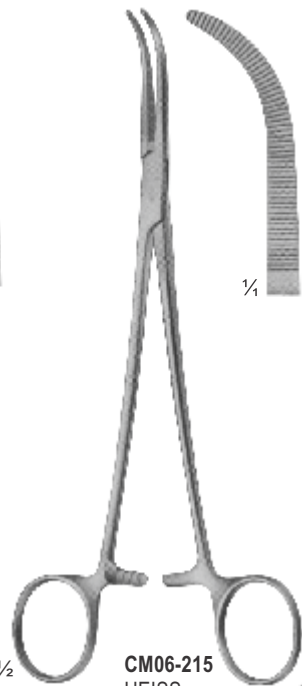

CM06-215
HEISS
195 mm

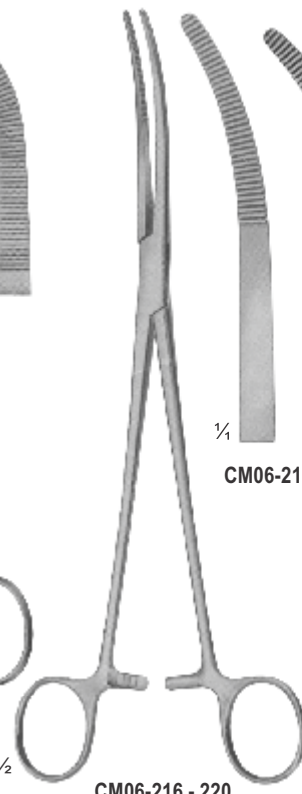

CM06-216 - 220
RUMEL
240 mm

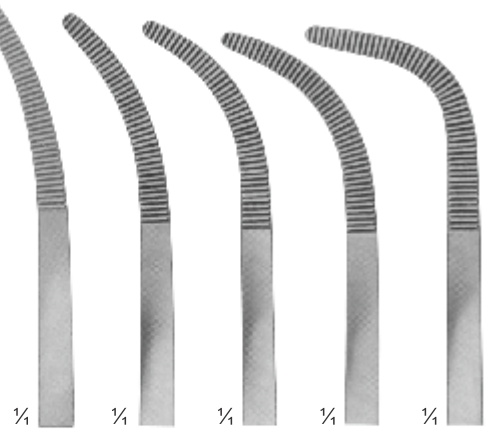

CM06-216 CM06-217 CM06-218 CM06-219 CM06-220

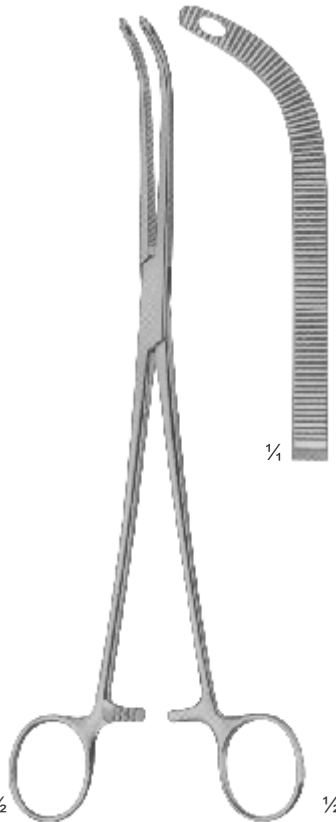

CM06-221
FINOCHIETTO
245 mm



CM06-222
MIXTER
230 mm



CM06-223
LAWRENCE
270 mm

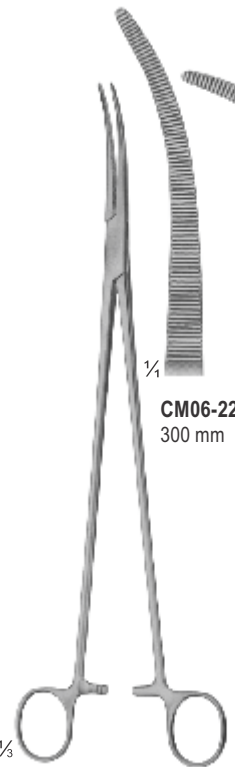

CM06-224 - 225
ZENKER



CM06-224 300 mm CM06-225 290 mm

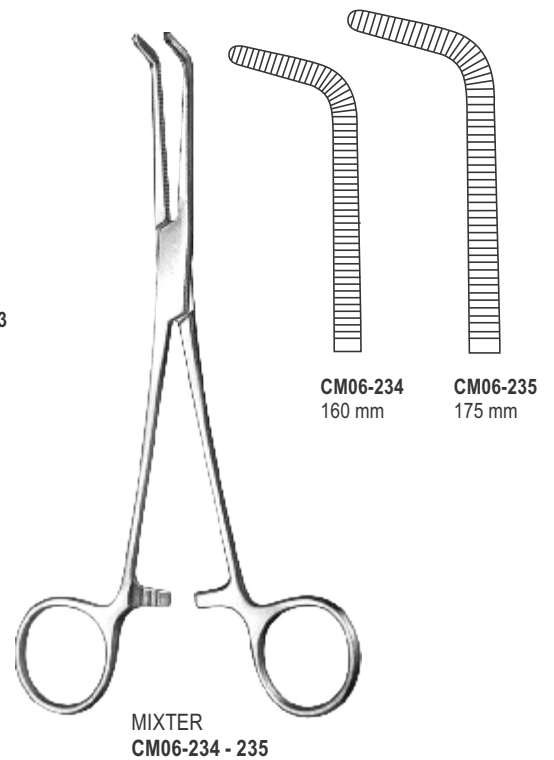
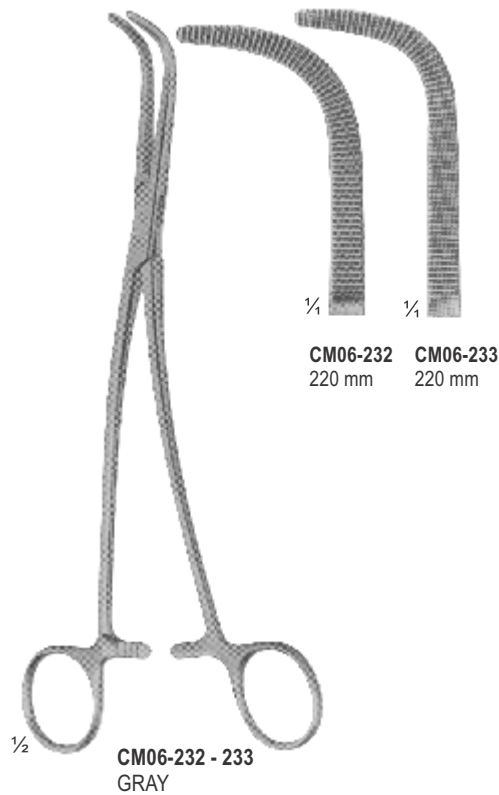
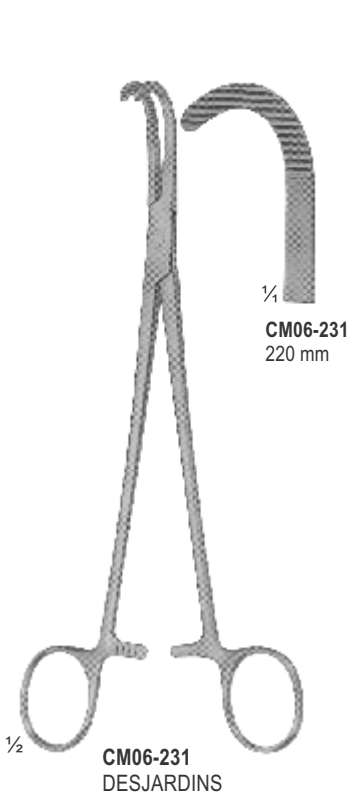
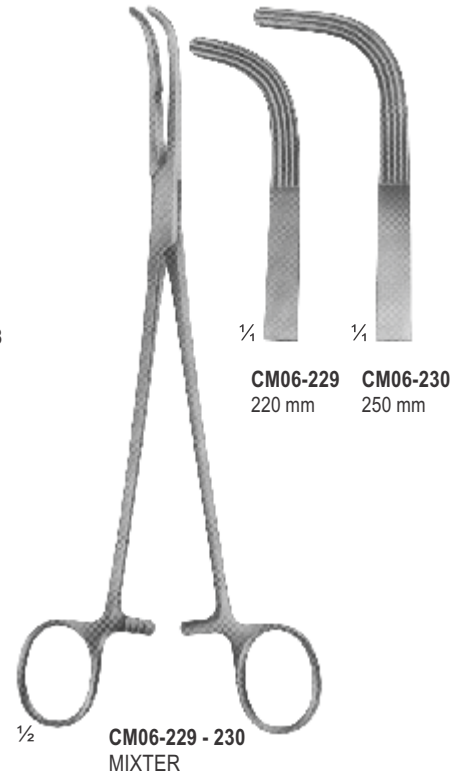
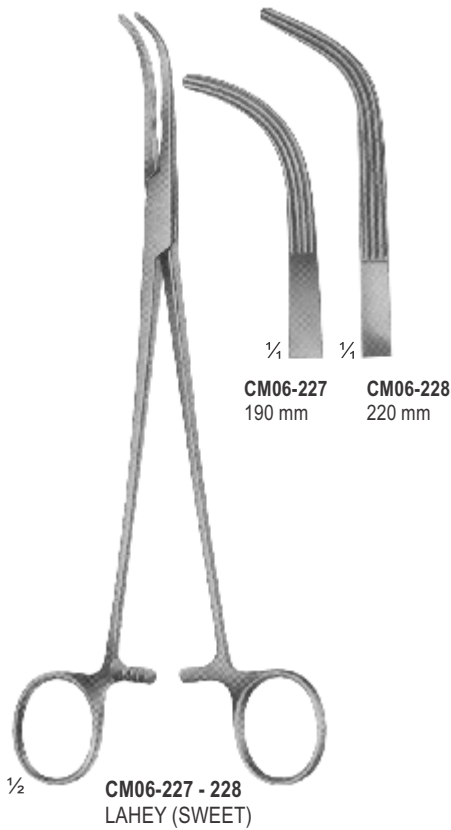
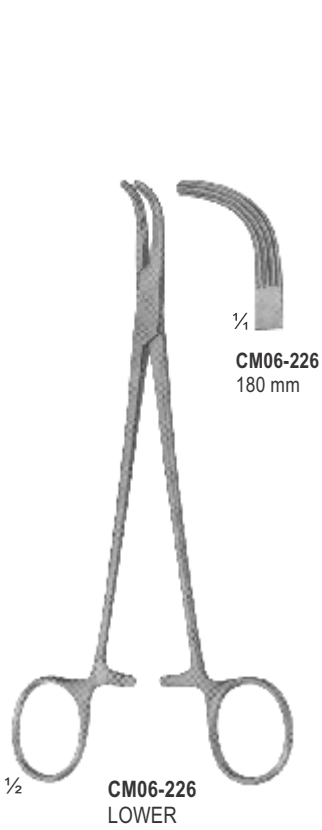

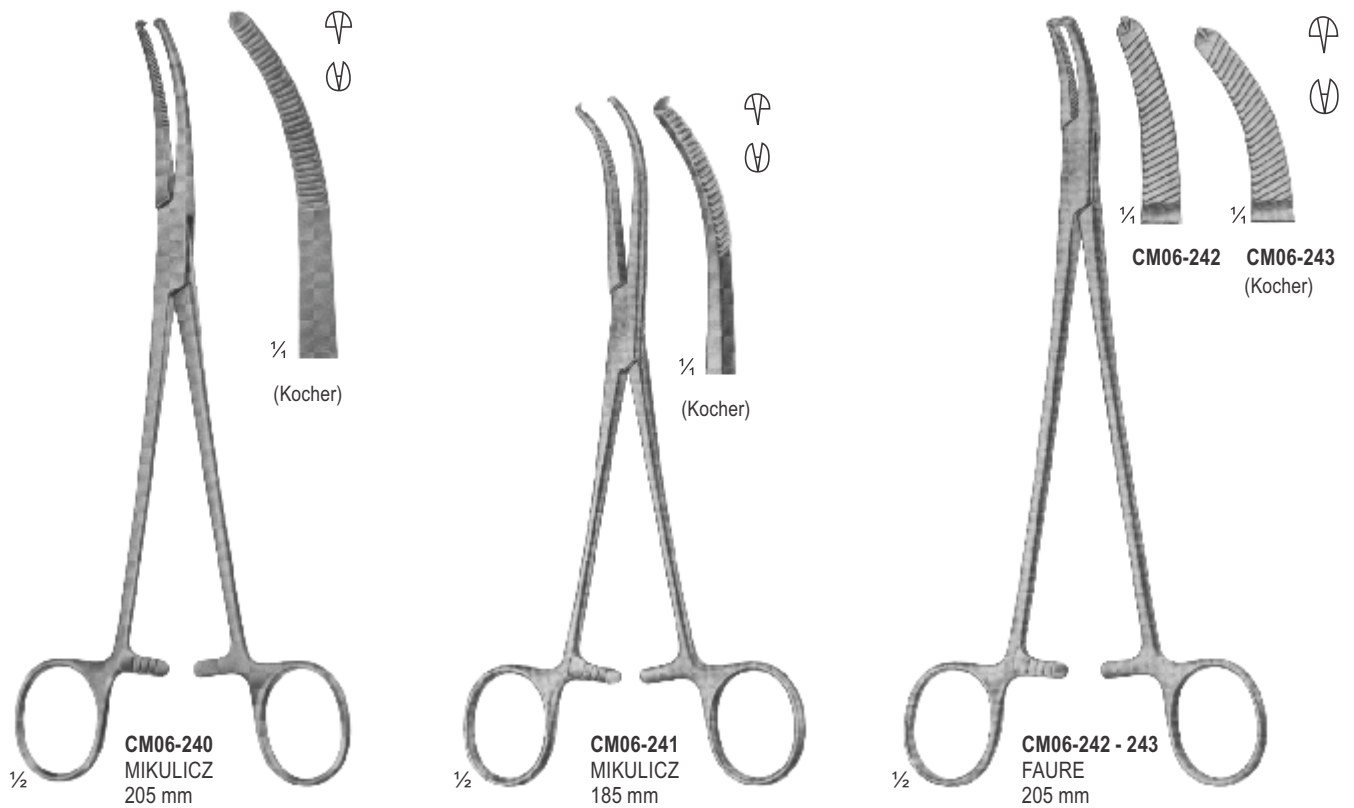
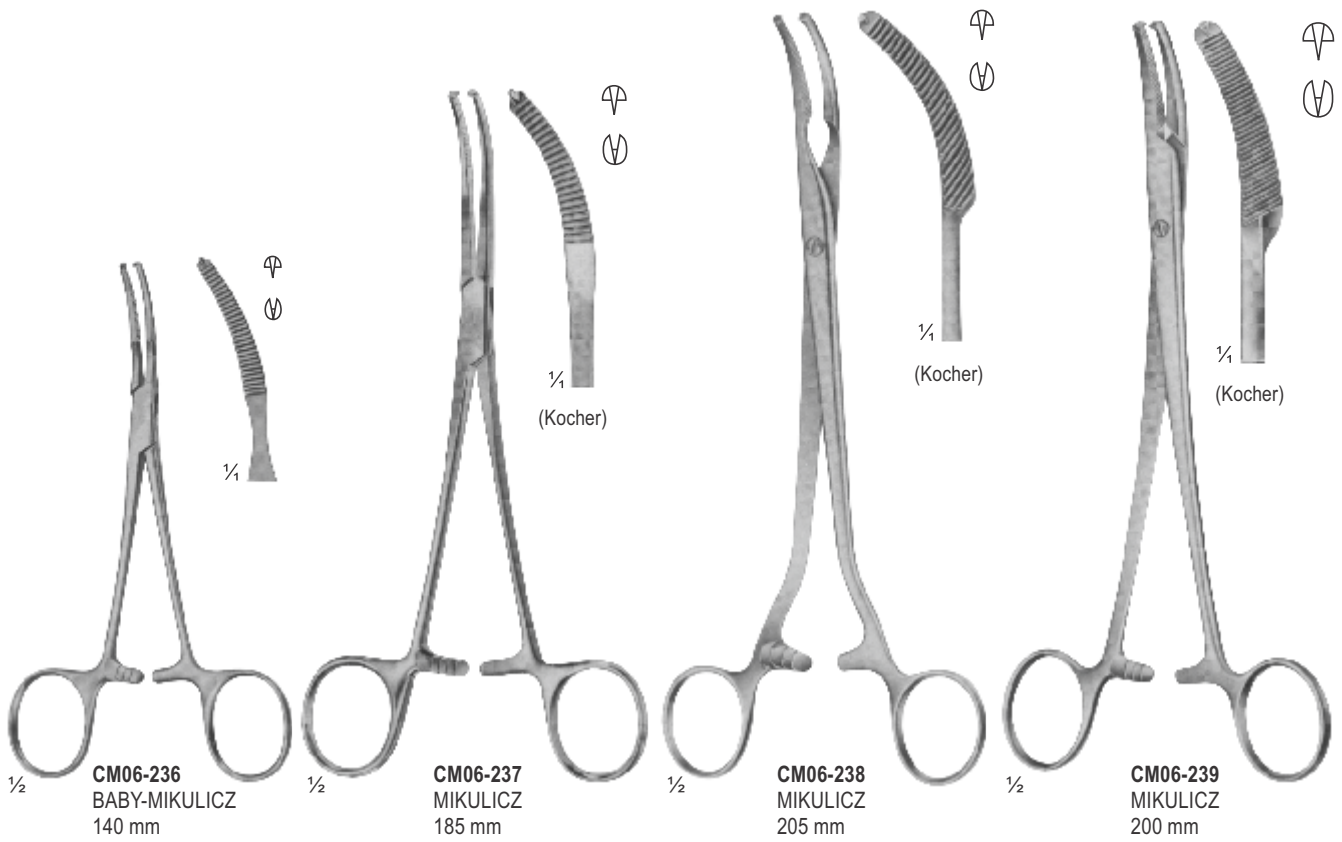

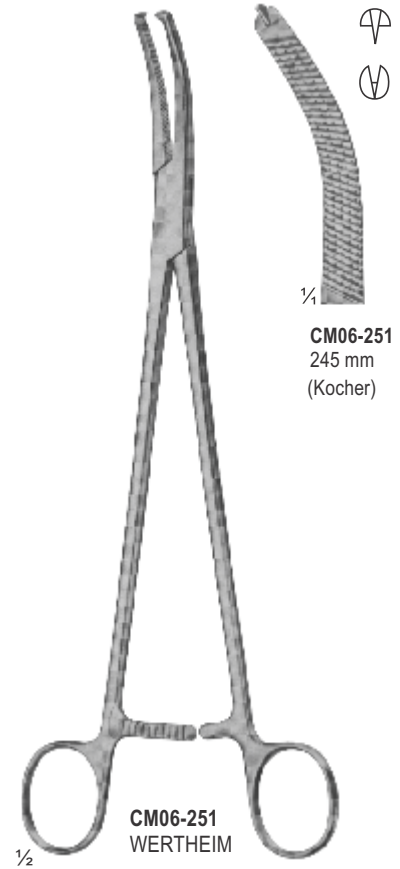
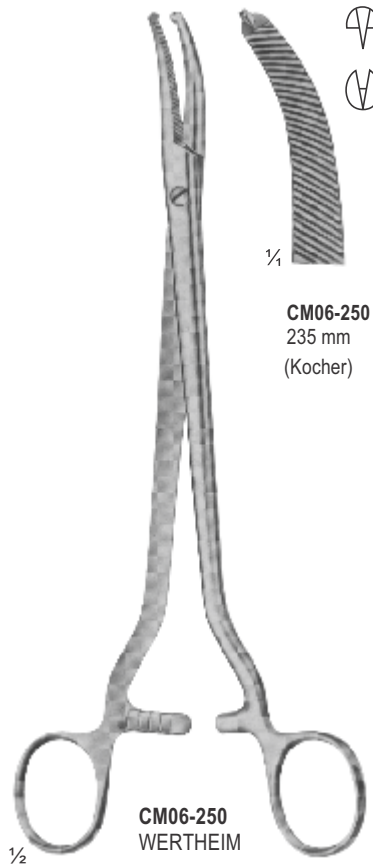
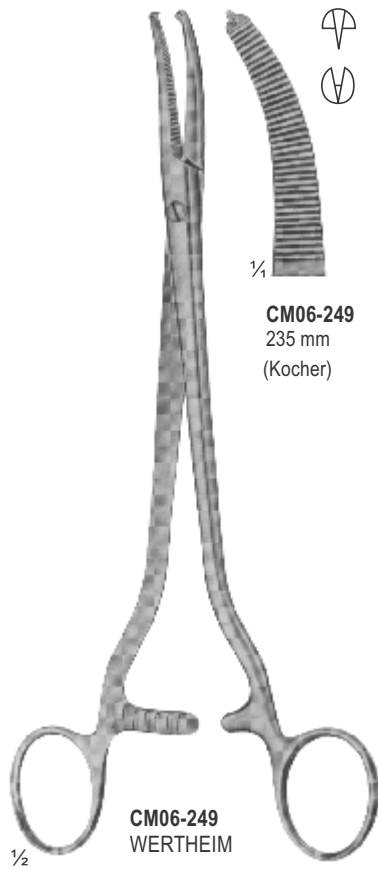
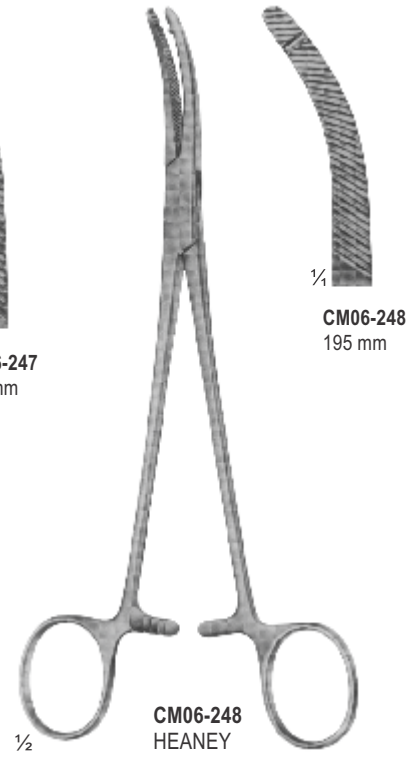
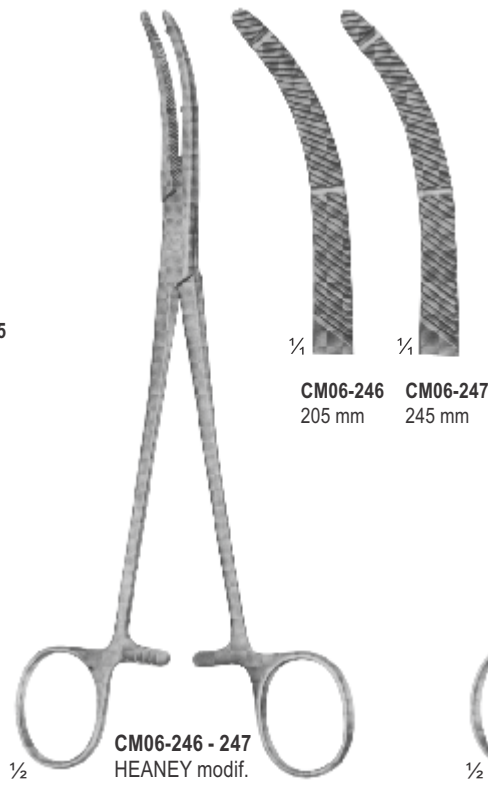
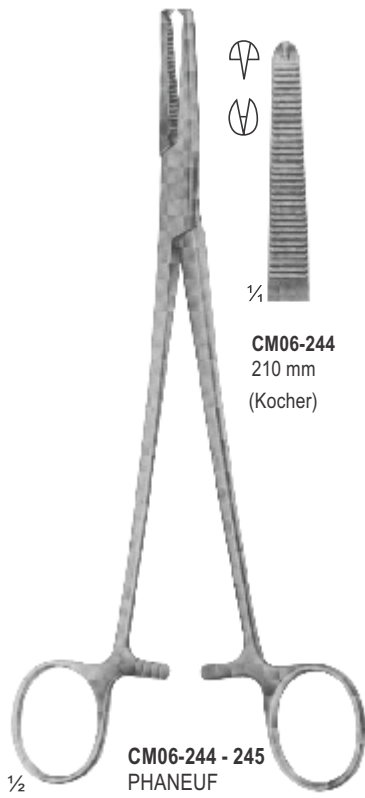



CM06-252 - 255
HEANEY



CM06-252
225 mm

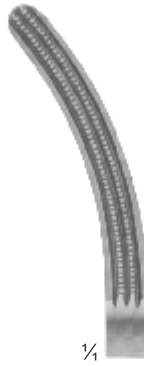

CM06-253
220 mm



CM06-254
215 mm

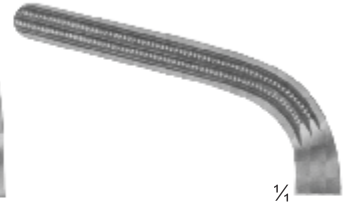

CM06-255
205 mm



CM06-256 - 259
WERTHEIM
Parametrium clamps



CM06-256
250 mm



CM06-257
245 mm



CM06-258
240 mm

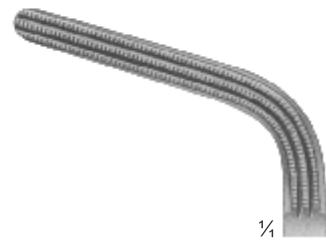

CM06-259
220 mm

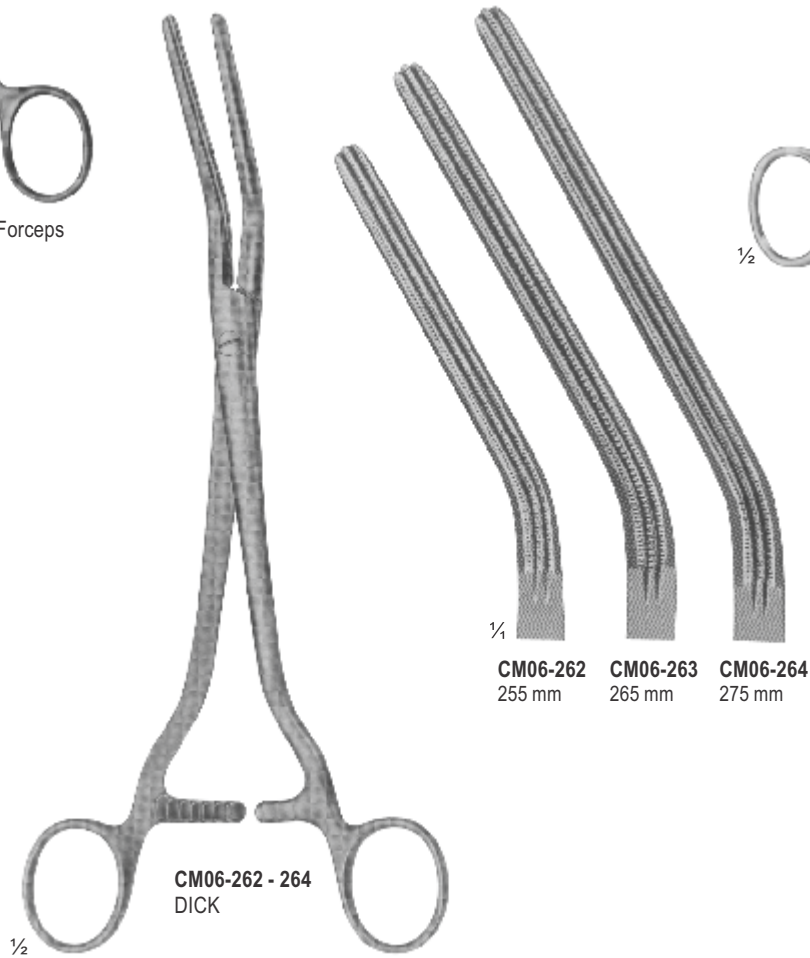
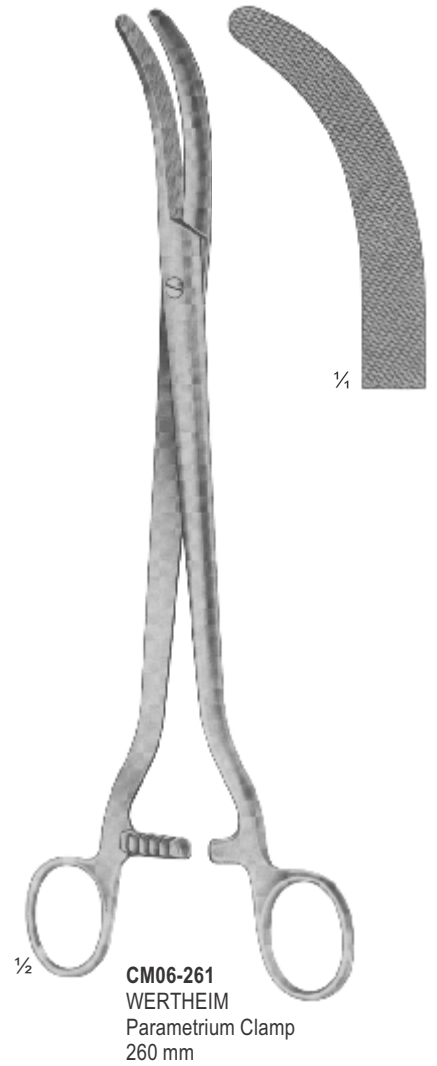
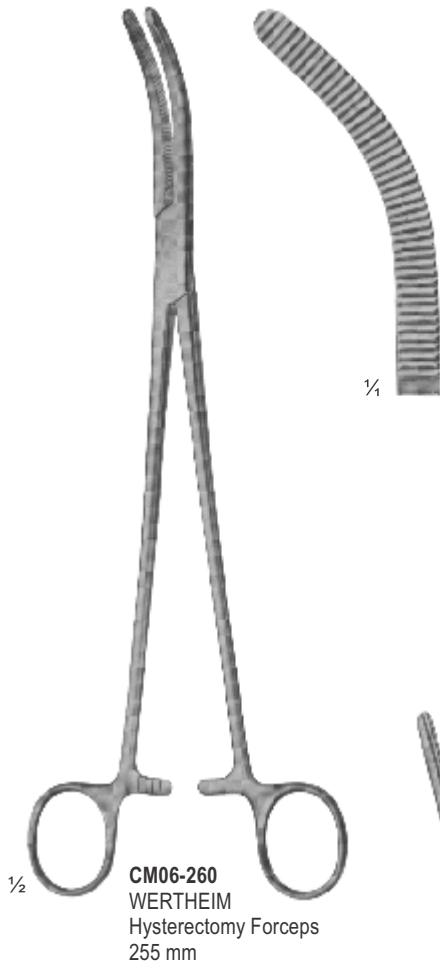

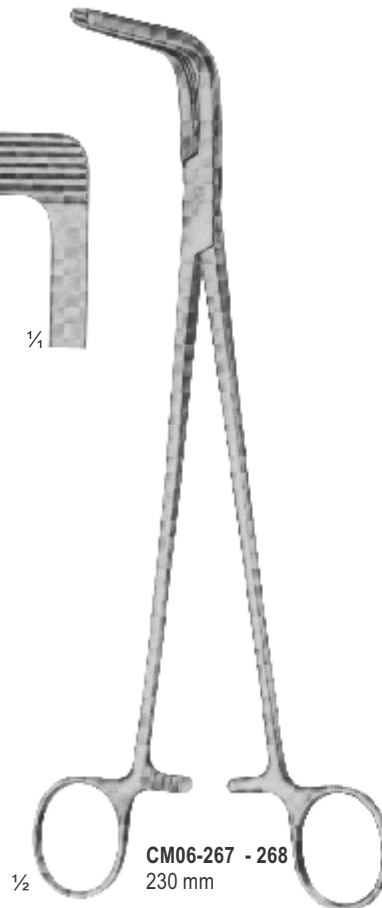
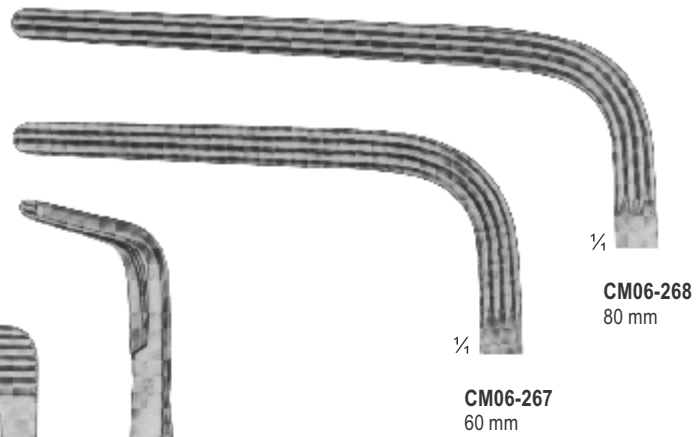
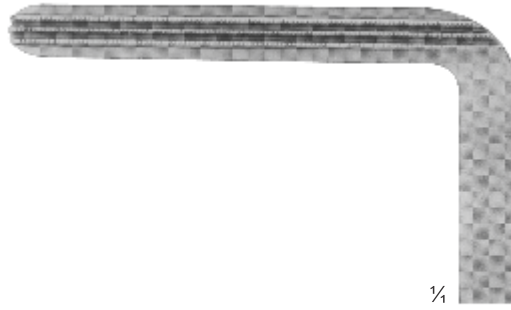

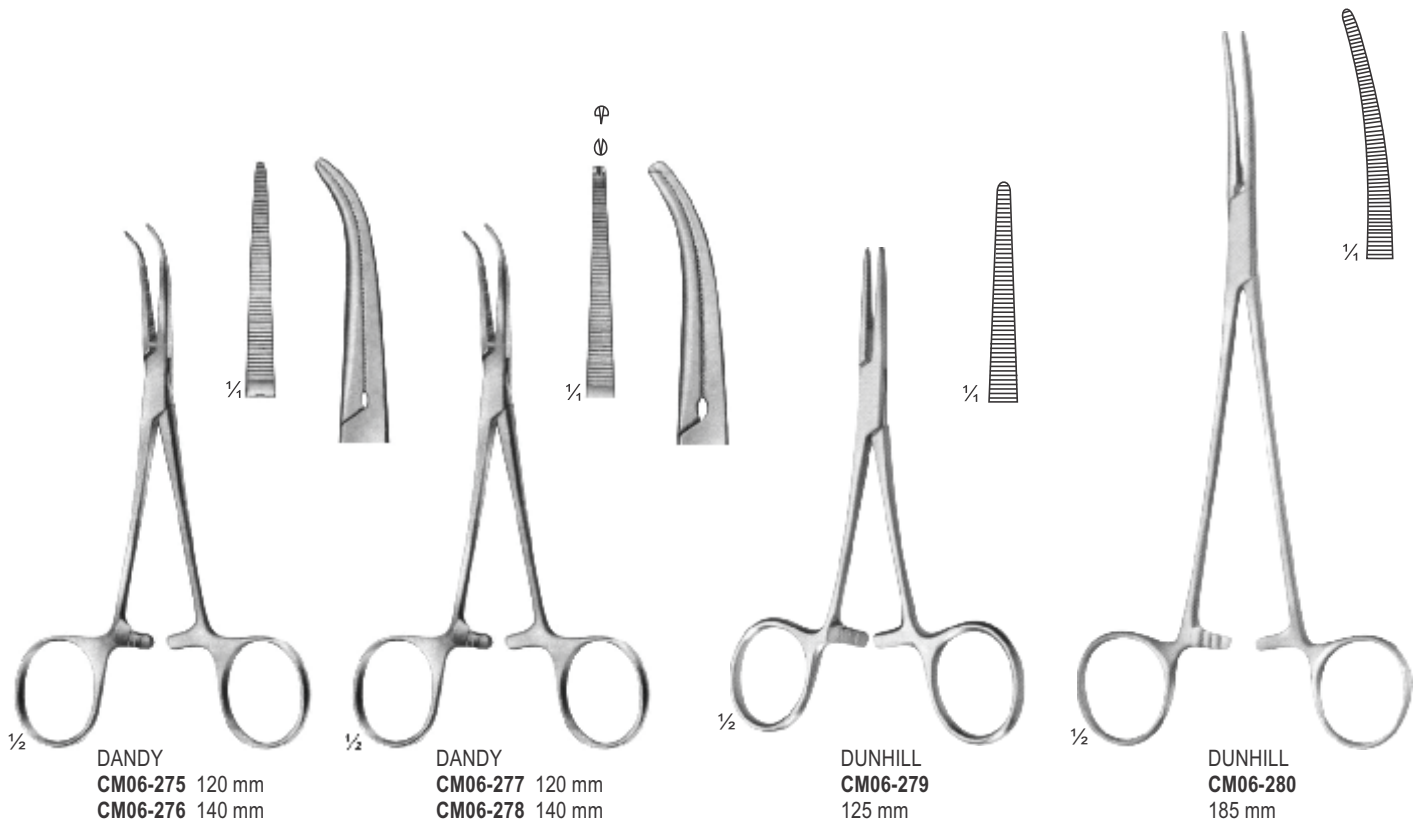
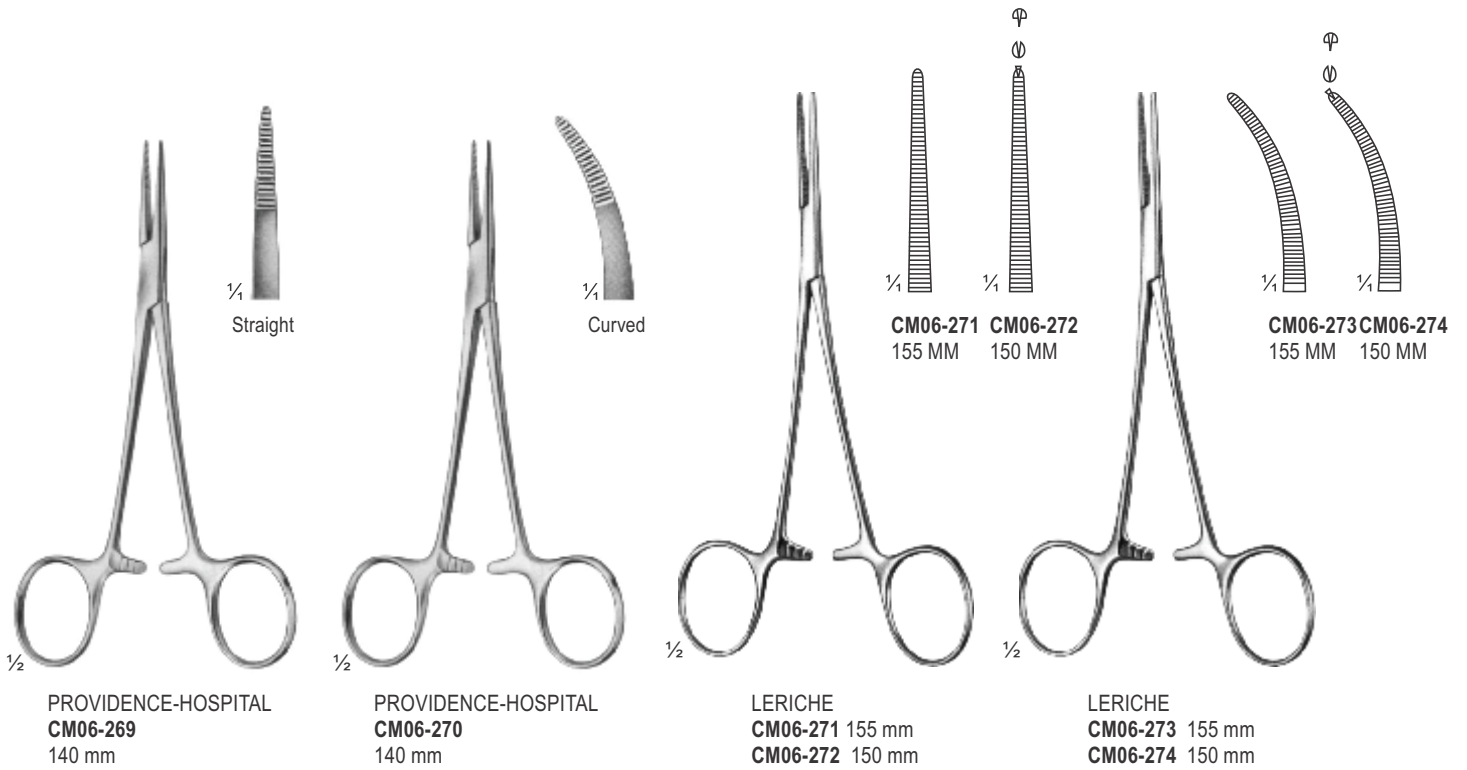

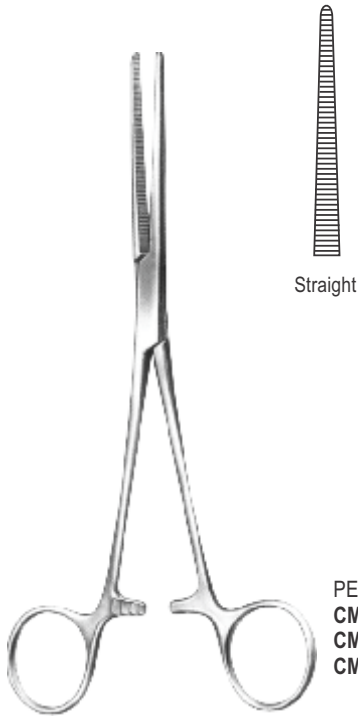

Straight

PEAN
CM06-281 130 mm
CM06-282 140 mm
CM06-283 170 mm

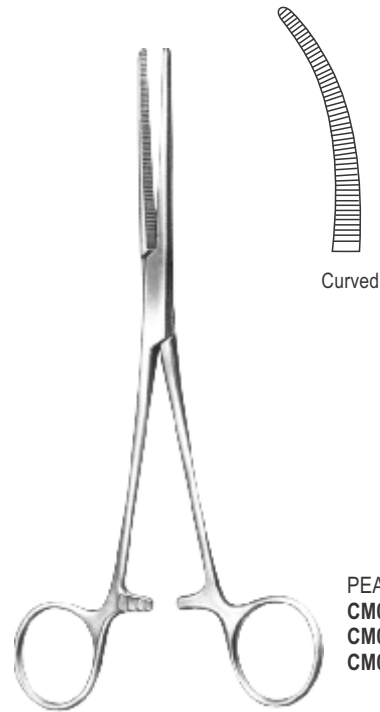

Curved

PEAN
CM06-284 130 mm
CM06-285 140 mm
CM06-286 170 mm

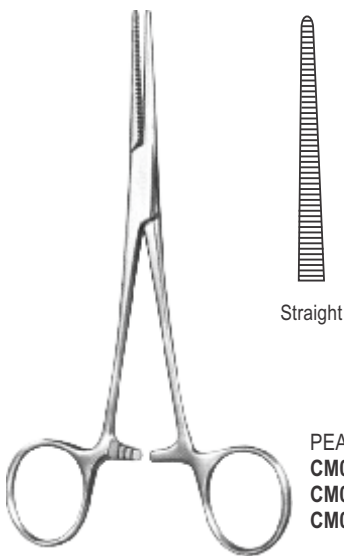

Straight

PEAN-Delicate
CM06-287 140 mm
CM06-288 160 mm
CM06-289 180 mm

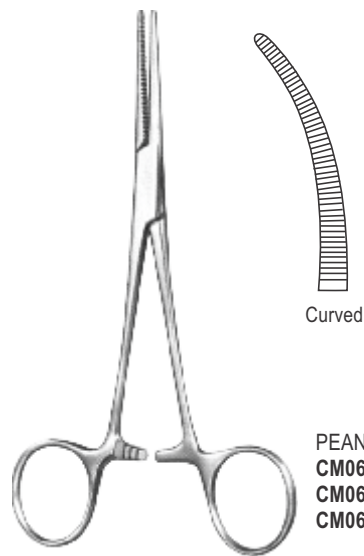

Curved

PEAN-Delicate
CM06-290 140 mm
CM06-291 160 mm
CM06-292 180 mm

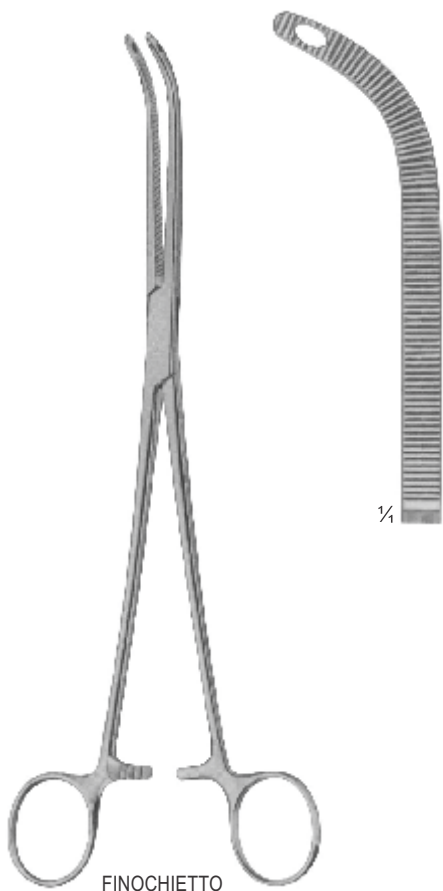

FINOCHIETTO
CM06-293
245 mm

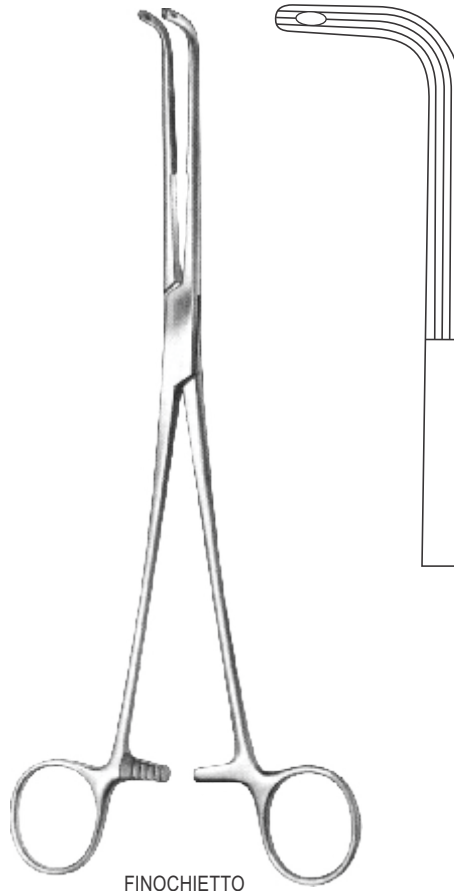

FINOCHIETTO
CM06-294
245 mm



LAHEY (SWEET)
CM06-295 190 mm
CM06-296 230 mm

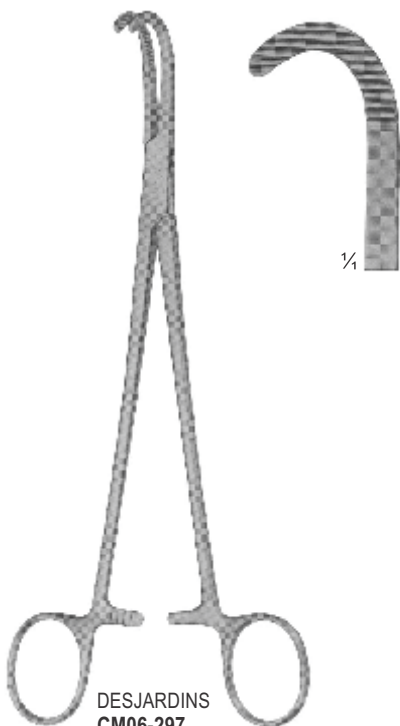

DESJARDINS
CM06-297
210 mm



LOWER
CM06-298
180 mm

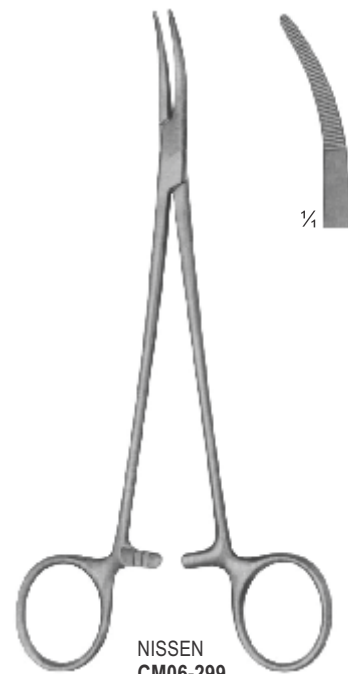

NISSEN
CM06-299
180 mm



GRAY
CM06-300 - 301
220 mm



CM06-300

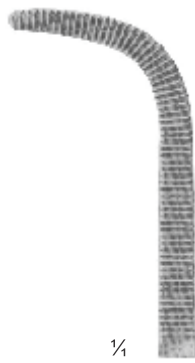

CM06-301



GRAY
CM06-302 - 303
220 mm



CM06-302

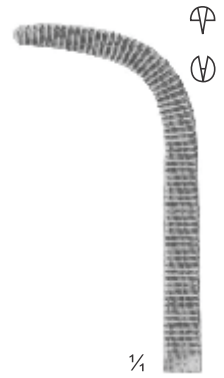

CM06-303



NEGUS
CM06-304 - 305
190 mm



CM06-304



CM06-305



MOYNIHAN
CM06-306 - 307



CM06-306
230 mm



CM06-307
240 mm

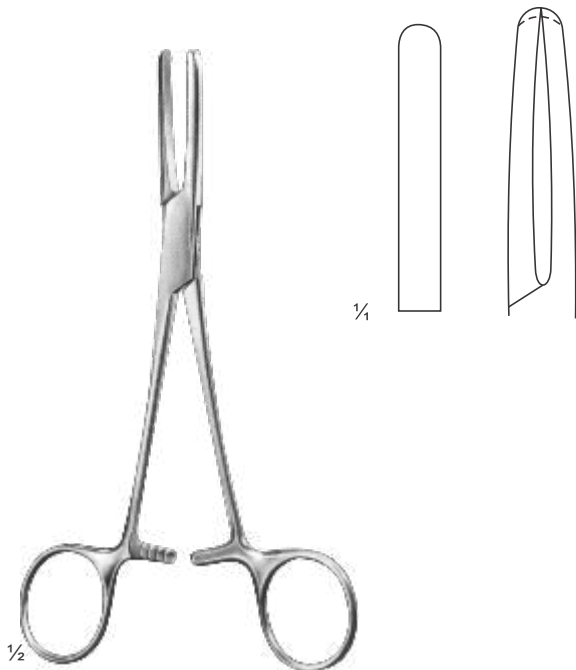

CM06-308
16.5 cm

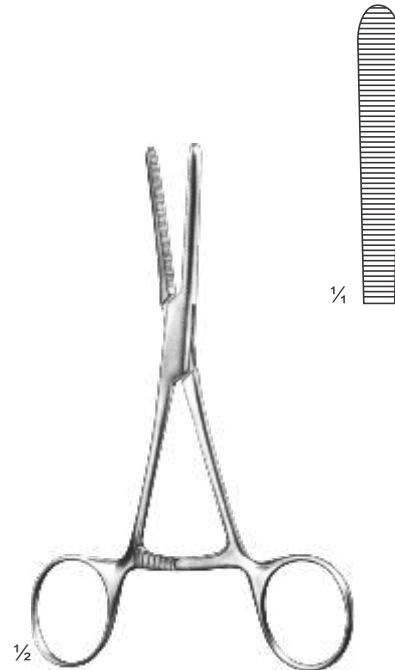

CM06-309
14 cm

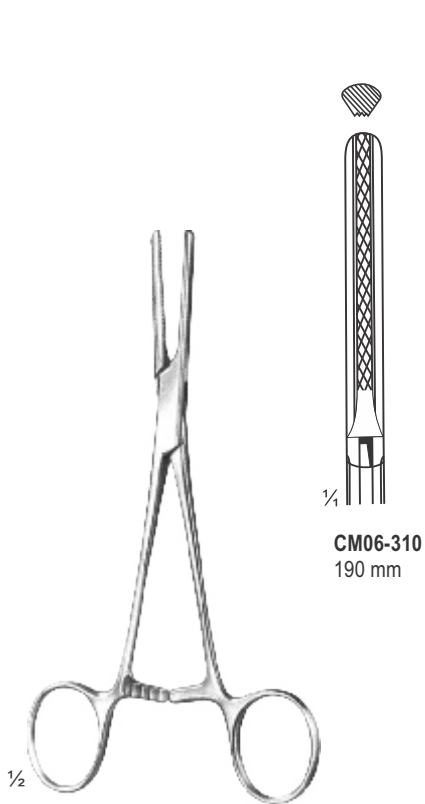

CM06-310
190 mm

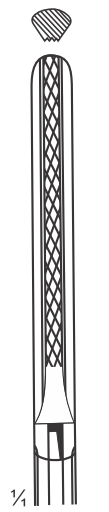

CM06-311
205 mm



CM06-312
155 mm

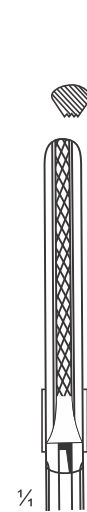

CM06-313
190 mm

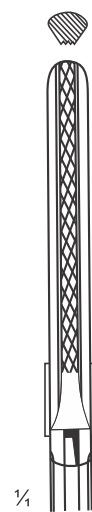

CM06-314
205 mm

CM06-310 - 311

CM06-312 - 314

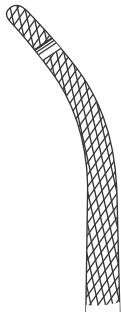

Fig. 1
CM06-315
195 mm

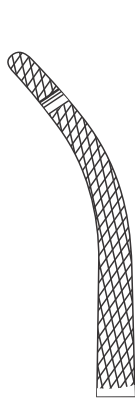

Fig. 1
CM06-316
215 mm

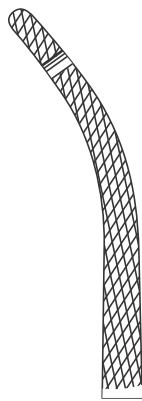

Fig. 1
CM06-317
240 mm

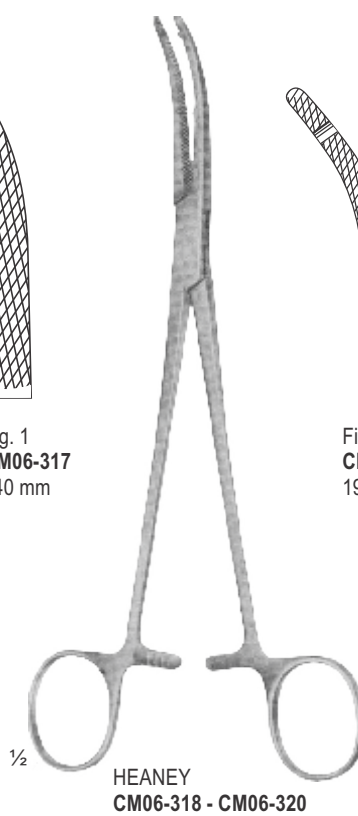

Fig. 2
CM06-318
195 mm



Fig. 2
CM06-319
215 mm

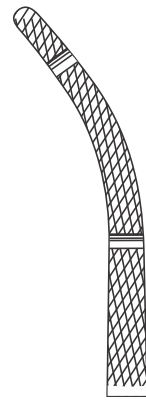
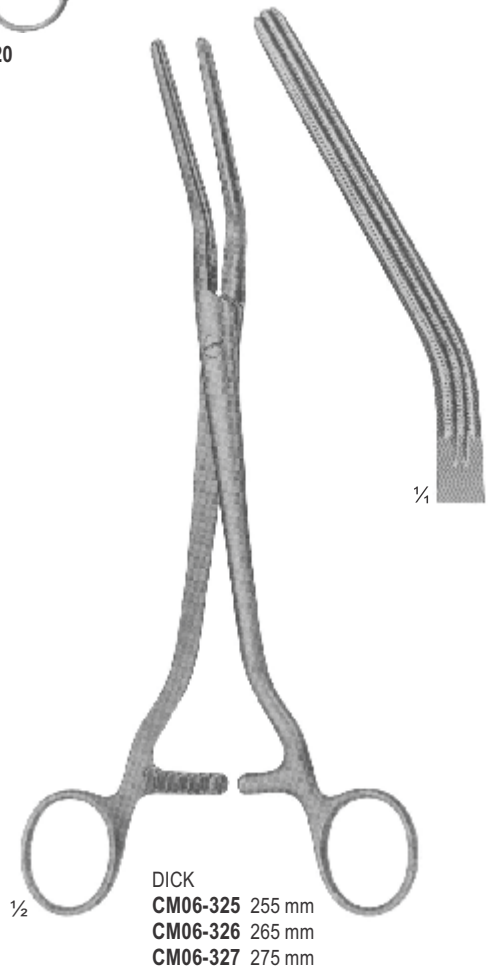
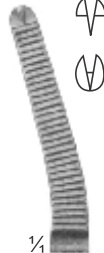
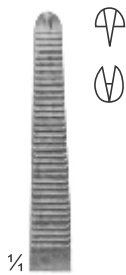
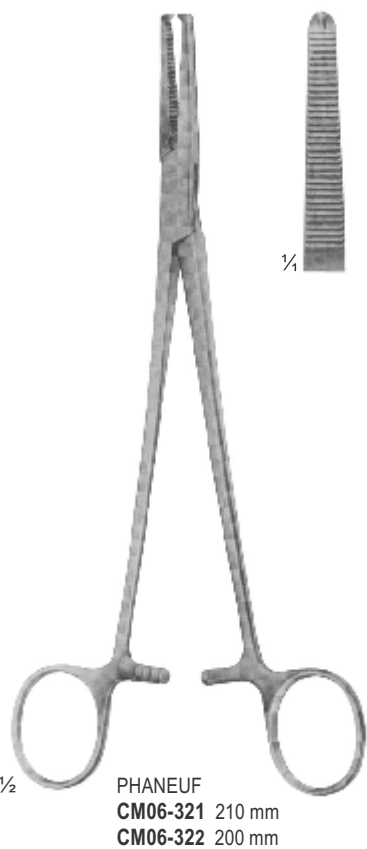

Fig. 2
CM06-320
240 mm





CARE MEDICAL[®]
SUPPLIES

Your health _ Our Priority

Section

07

Page 116-124

Sponge And Dressing Forceps
Organ And Tissue Grasping Forceps
Tendon Seizing Forceps
Towel Clamps

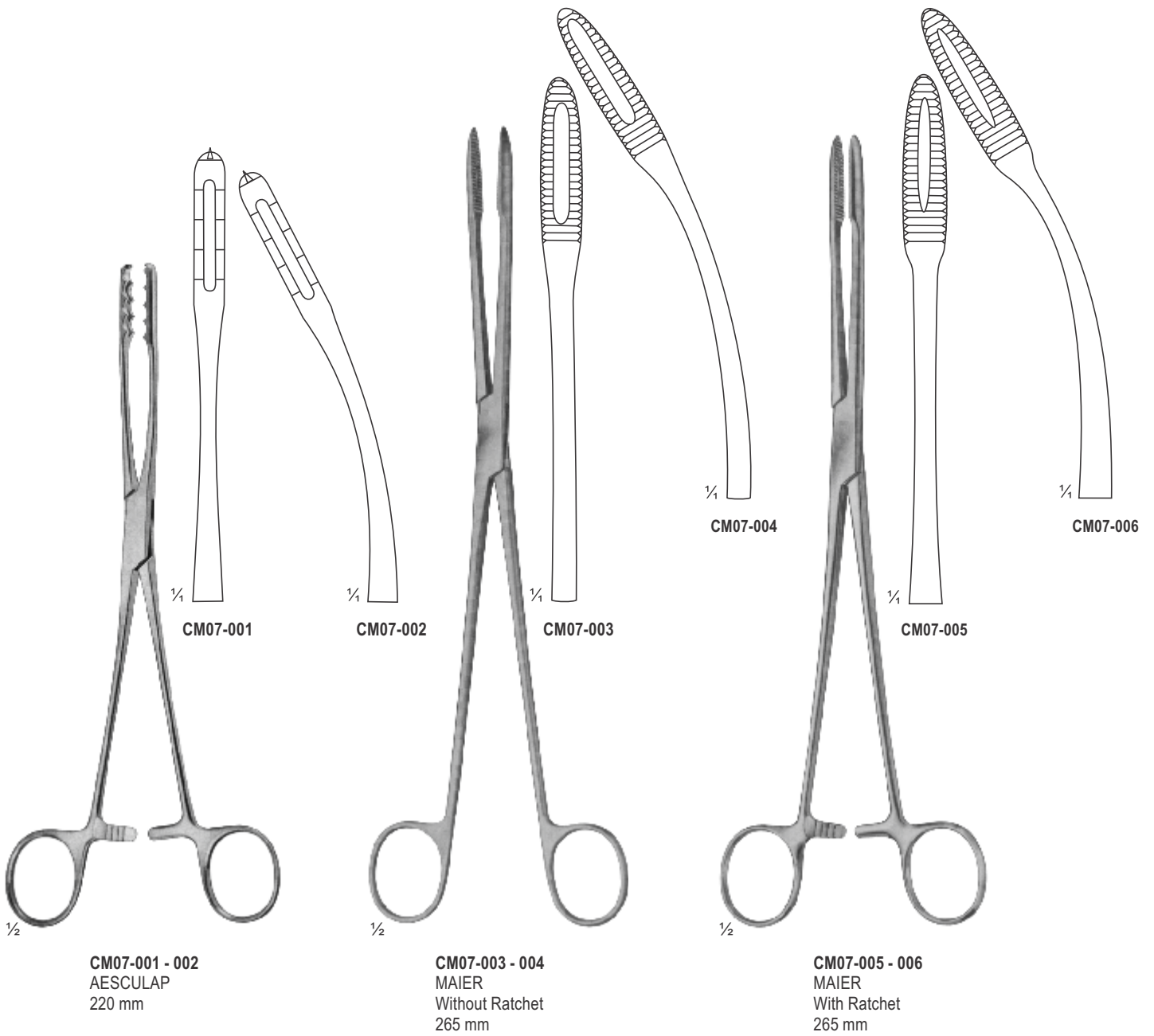

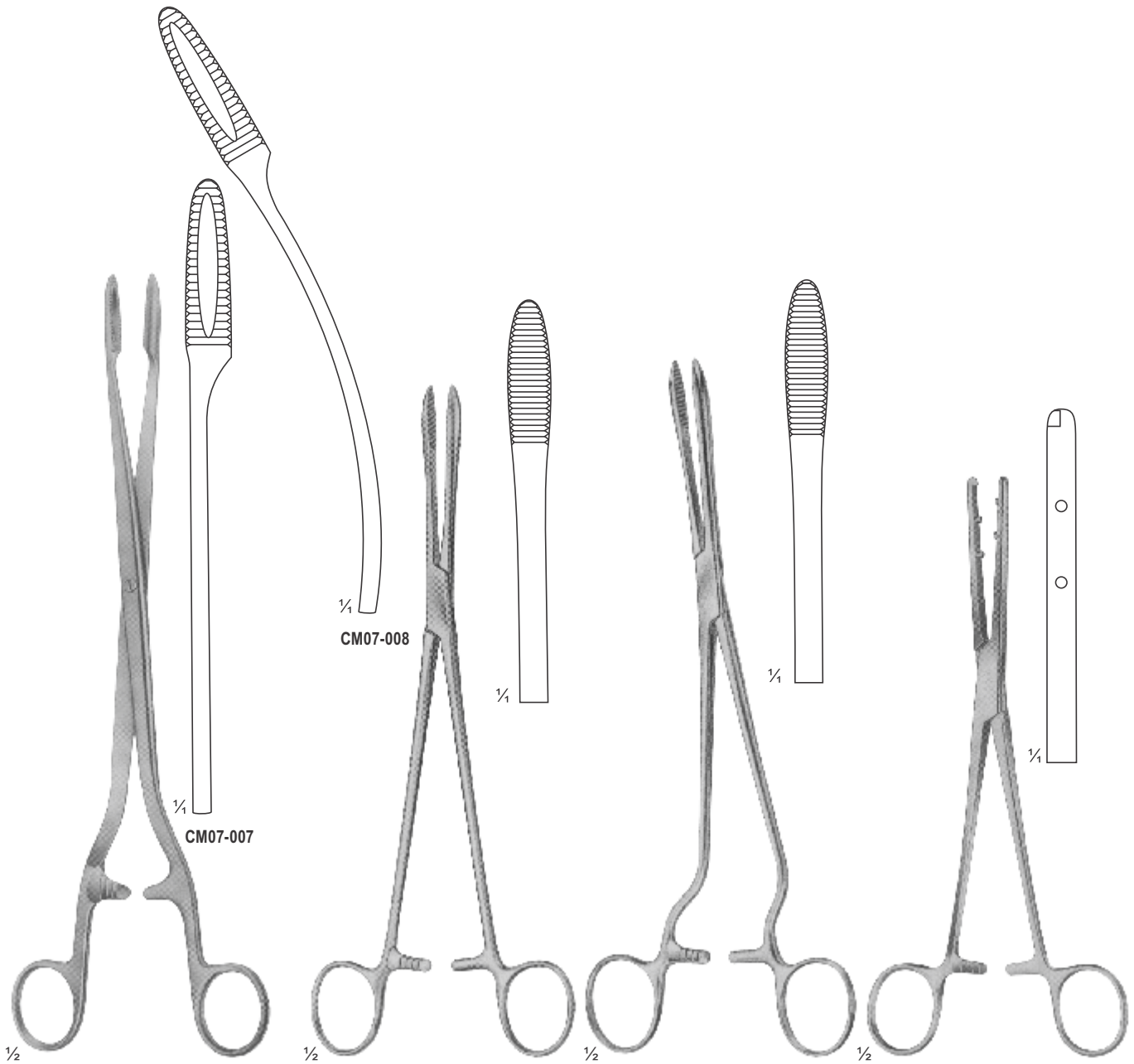

CM07-007 - 008
SIMS-MAIER
280 mm

CM07-009
COLLIN
240 mm

CM07-010
CHERON
Handles Laterally Angled
240 mm

CM07-011
EMMET
210 mm

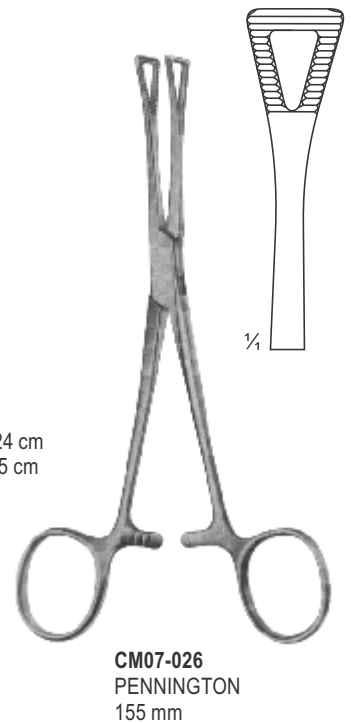
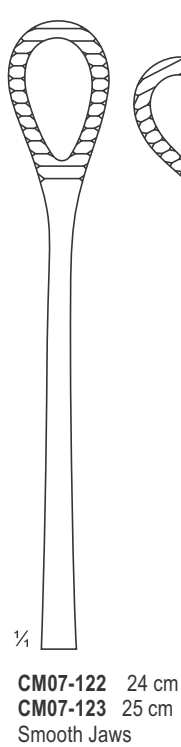
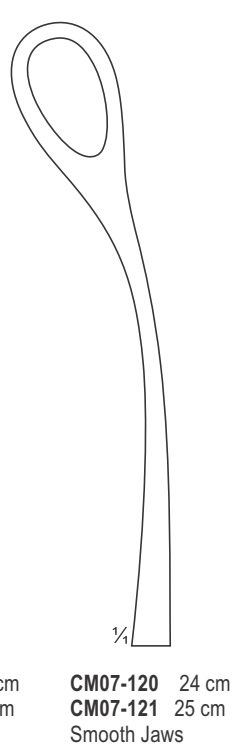
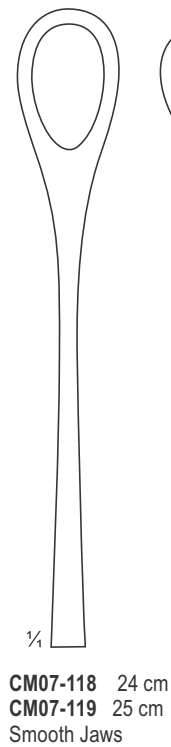
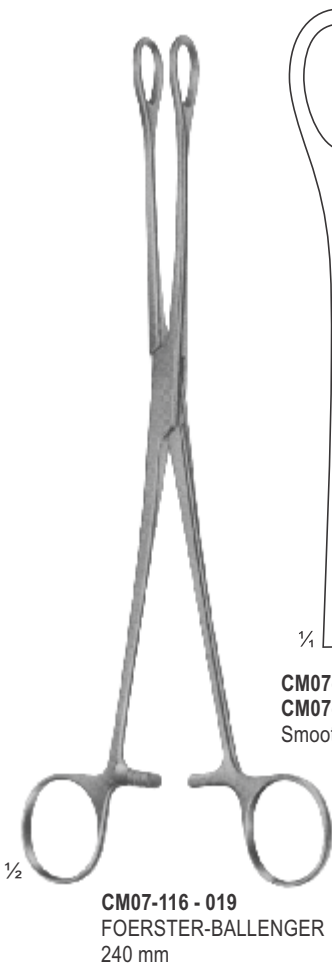
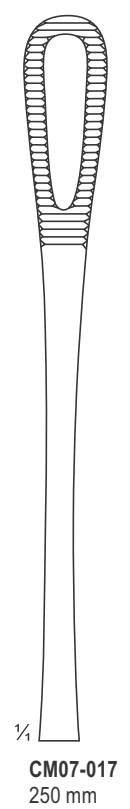
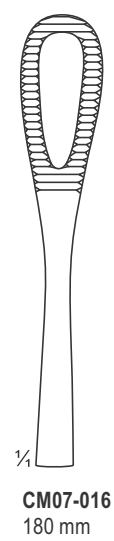
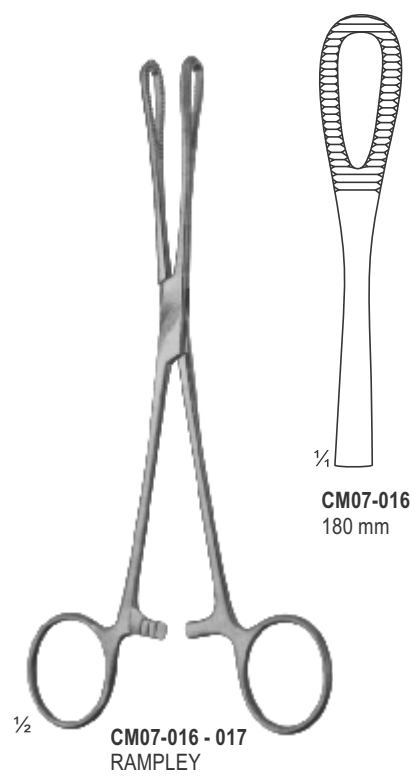
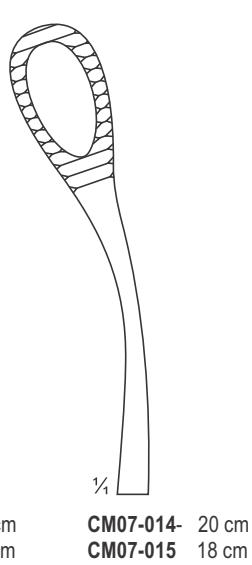
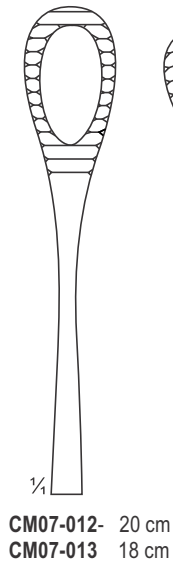
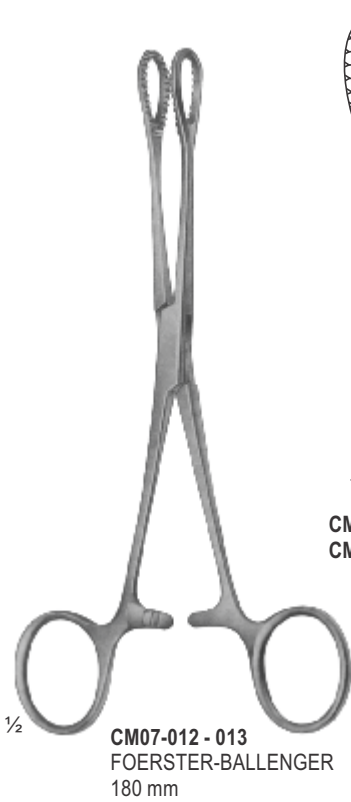

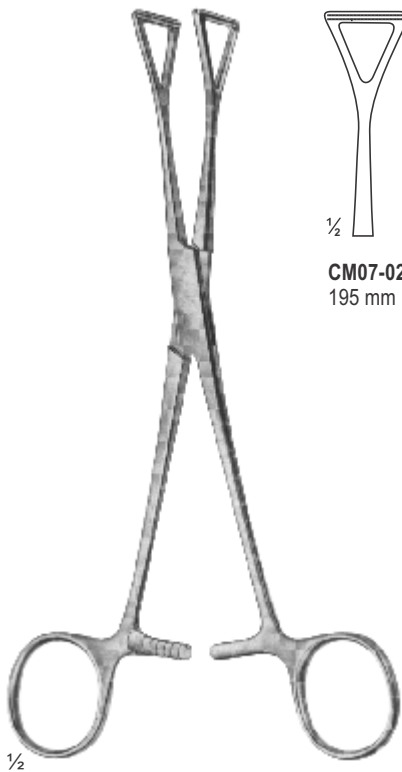

CM07-027 - 028
COLLIN



CM07-027
195 mm

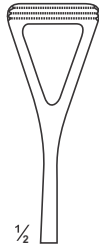

CM07-028
230 mm

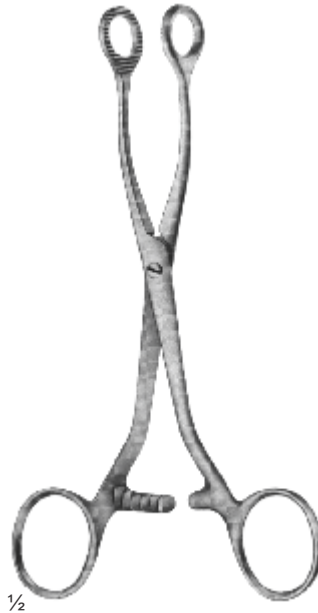

CM07-029 - 031
COLLIN

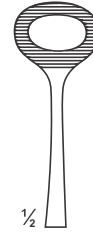

CM07-029
160 mm

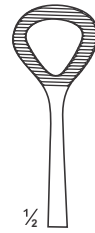

CM07-030
160 mm



CM07-031
170 mm

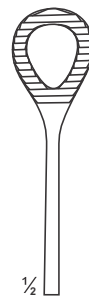
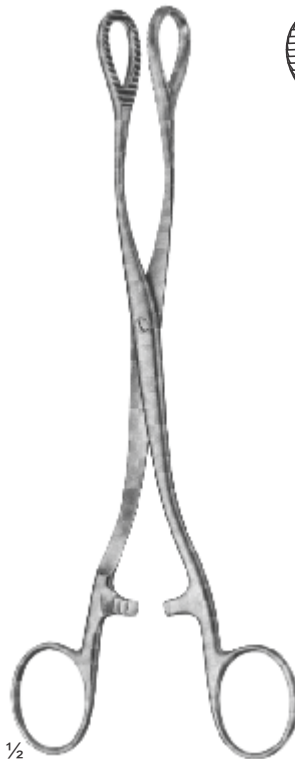

CM07-032
HEYWOOD-
SMITH
200 mm

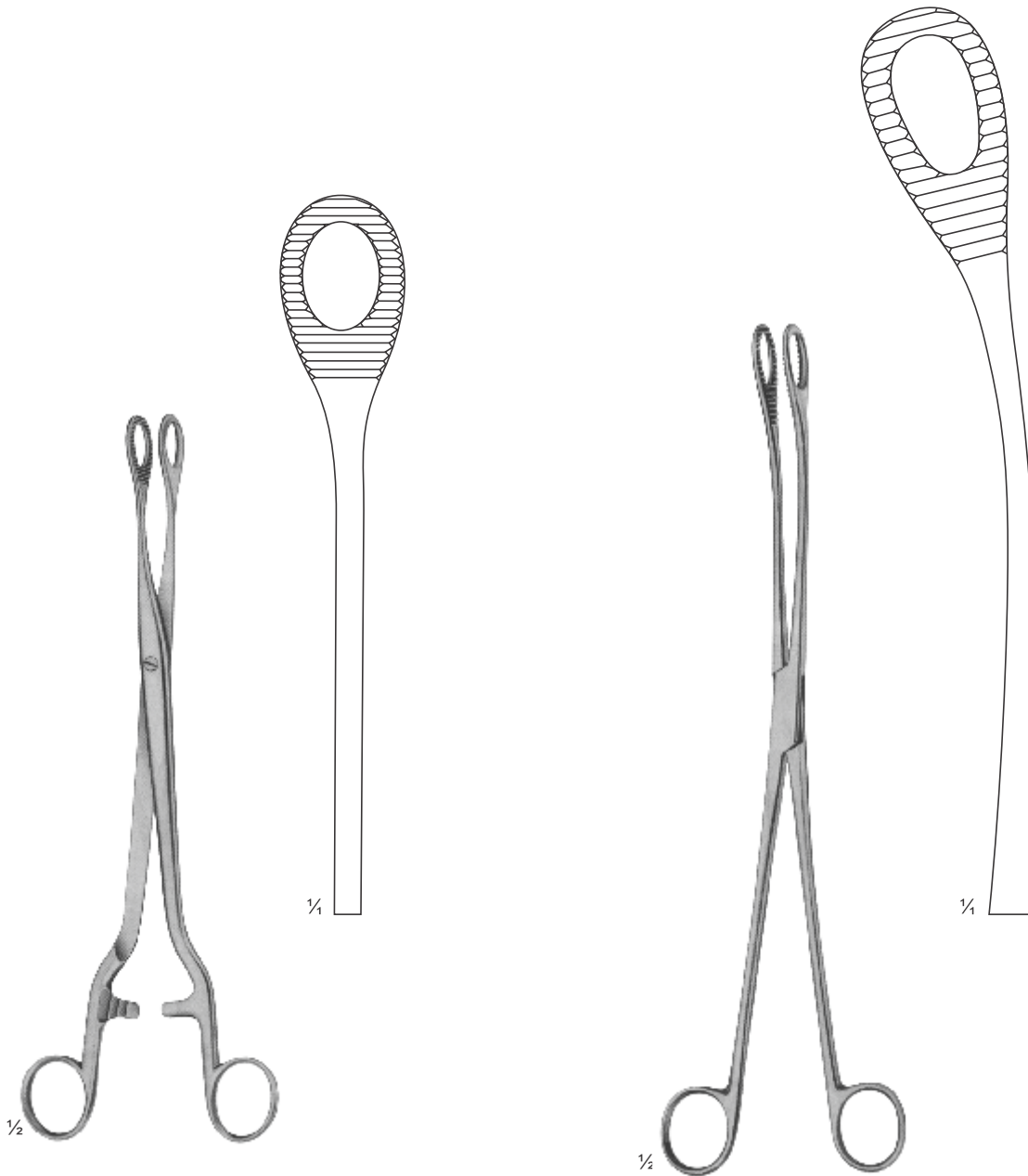

CM07-033
NOTO
280 mm

CM07-034
KELLY
320 mm

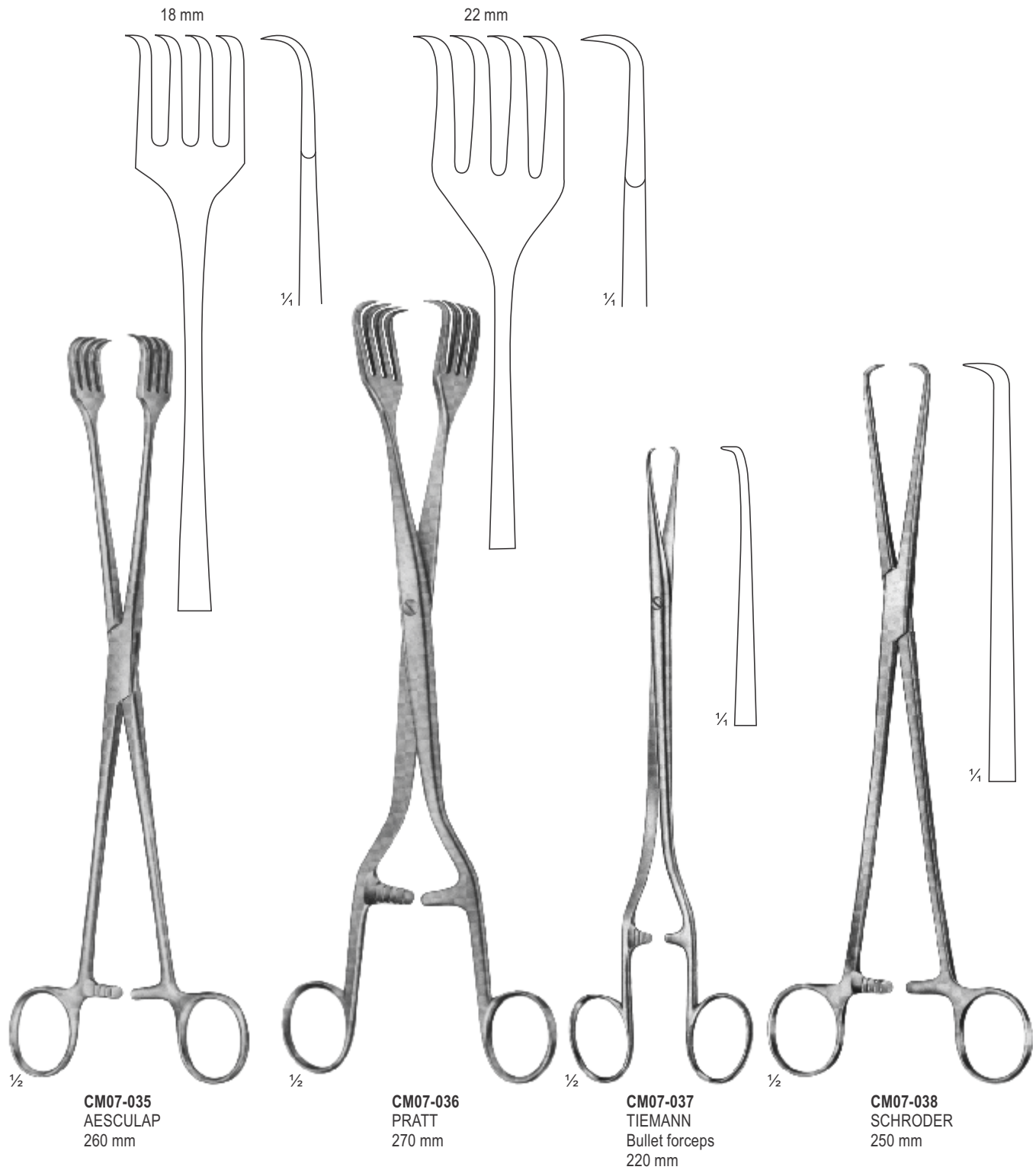

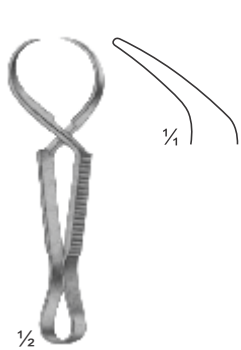

CM07-039
JONES
85 mm

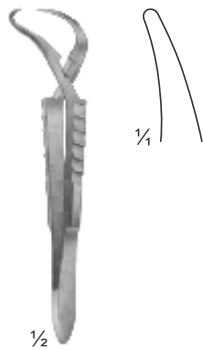

CM07-040
ENGL. MOD.
85 mm

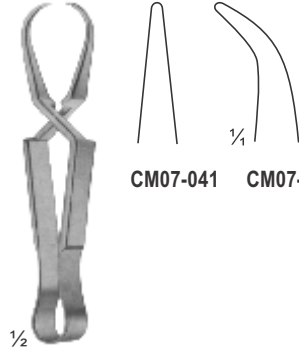

CM07-041 - 042
SCHAEDEL
85 mm

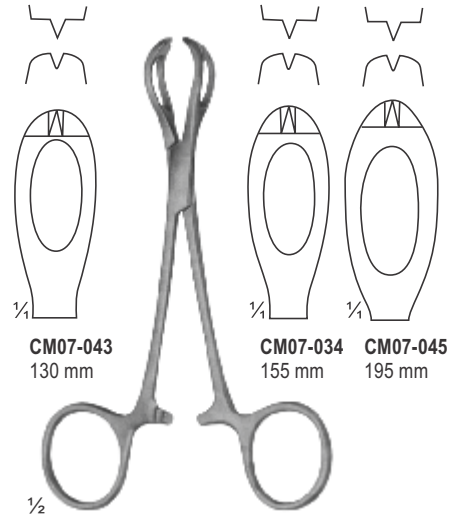

CM07-043 - 045
LANE

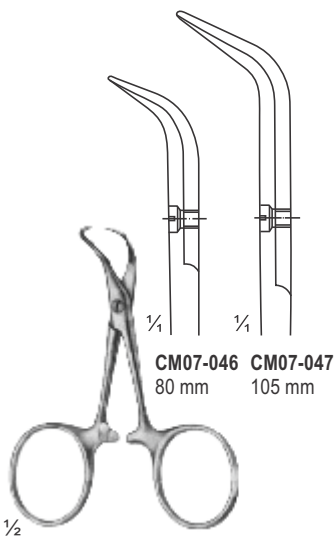

CM07-046 - 047
BACKHAUS

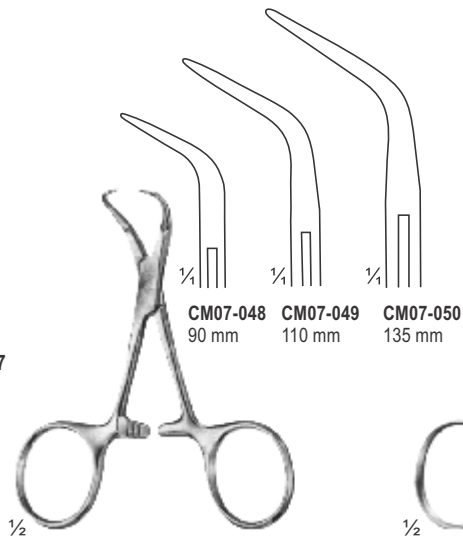

CM07-048 - 050
BACKHAUS

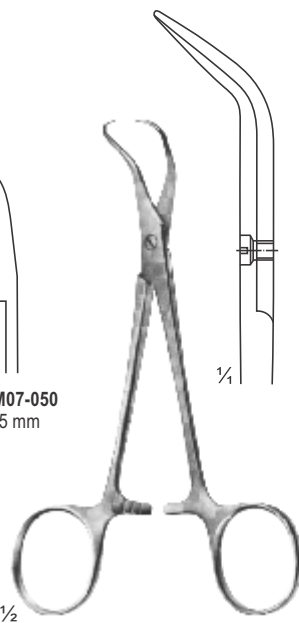

CM07-051
BACKHAUS-KOCHER
135 mm

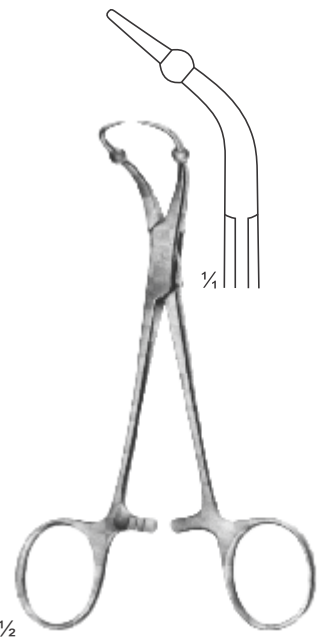

CM07-052
ROEDER
135 mm

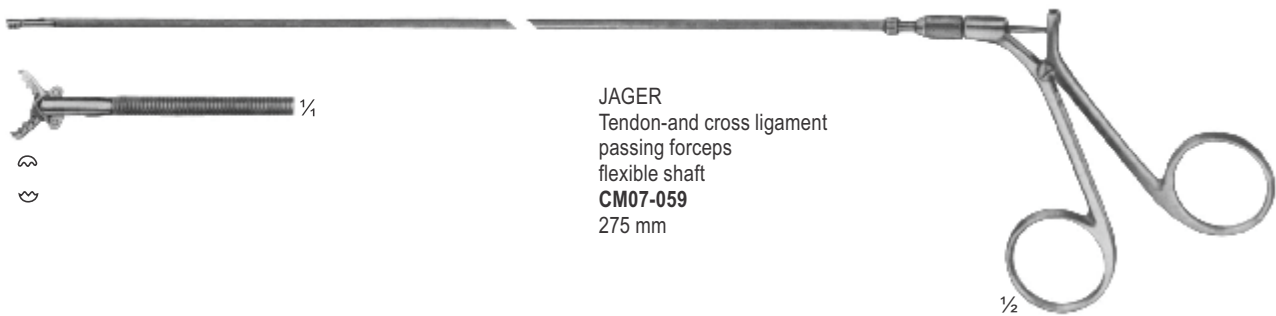
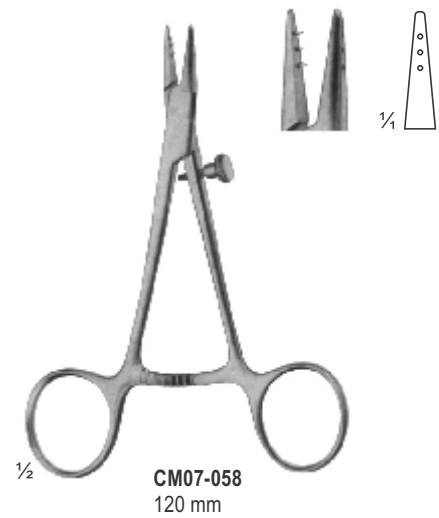
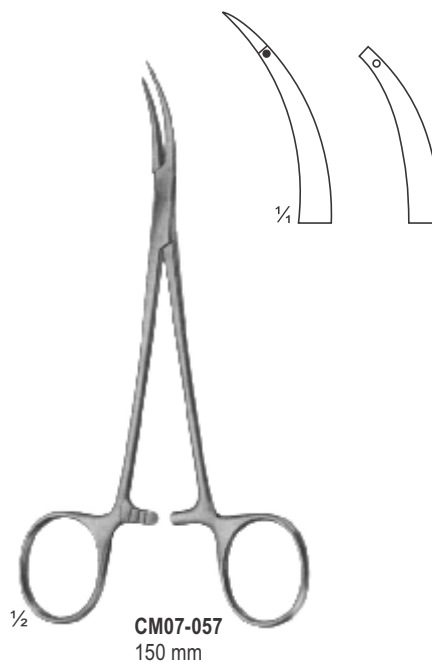
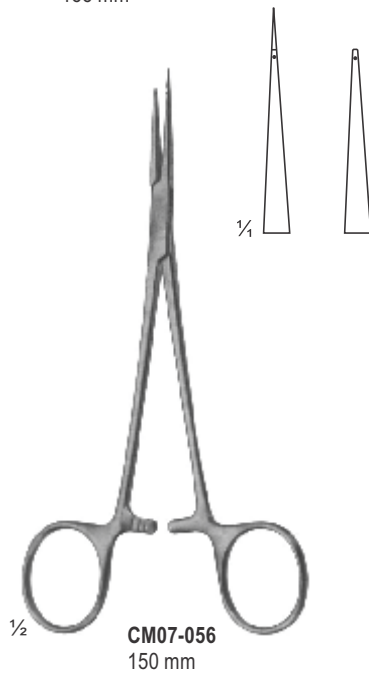
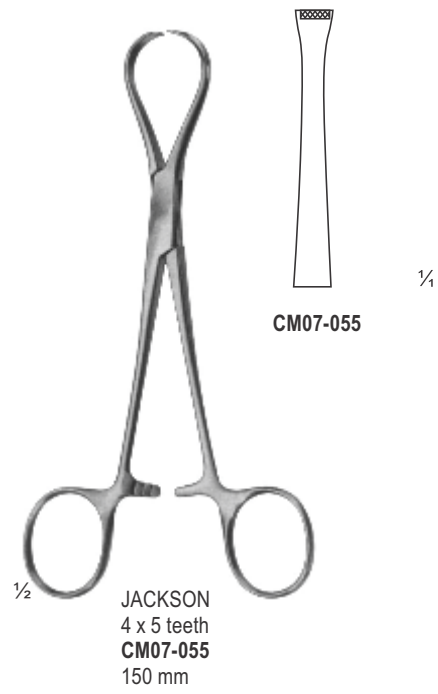
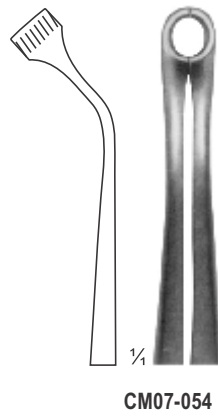
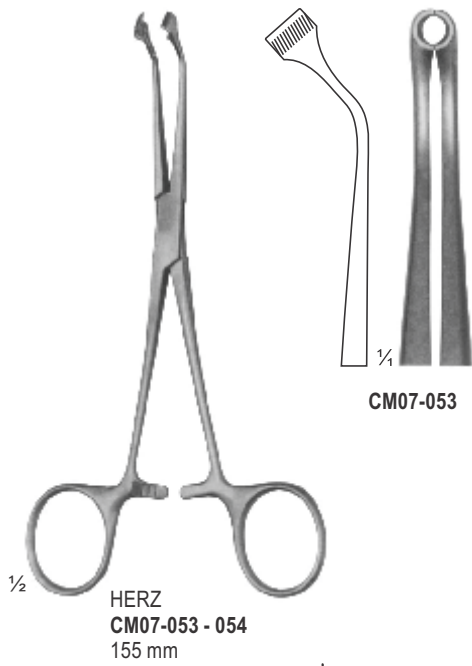

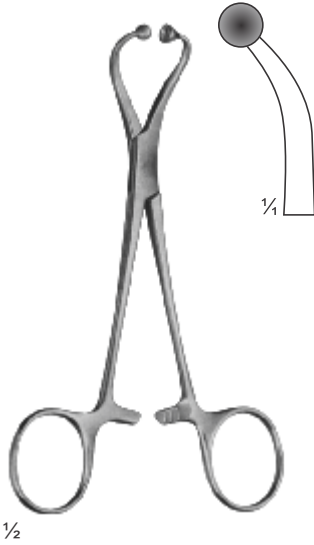

CM07-060
for paper cloths
140 mm

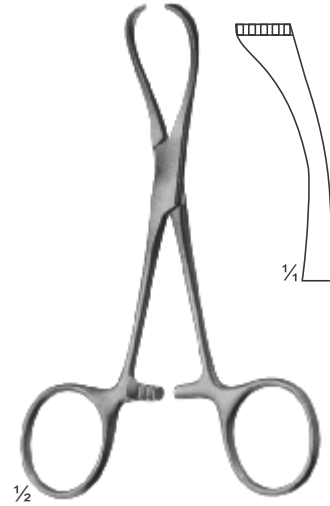

CM07-061
LORNA
non perforating
130 mm

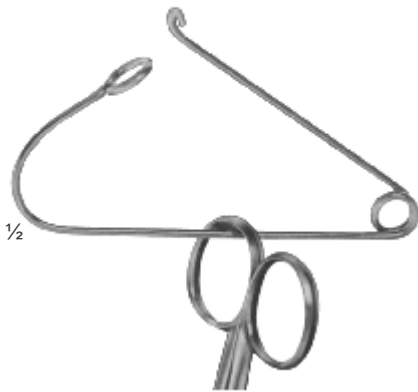

CM07-062
BUNT
105 mm



CM07-063
MAYO
140 mm



CARE MEDICAL[®]
S U P P L I E S

Your health _ Our Priority

Section

08

Page 125-145

Needle Holders
Guiding Probes
Suture Instruments - Ligature Needles
Needle Holders With Tungsten Carbide Inserts



¼

½

CRILE-MURRAY
CM08-001
15 cm



¼

½

CRILE-WOOD
CM08-002
16 cm

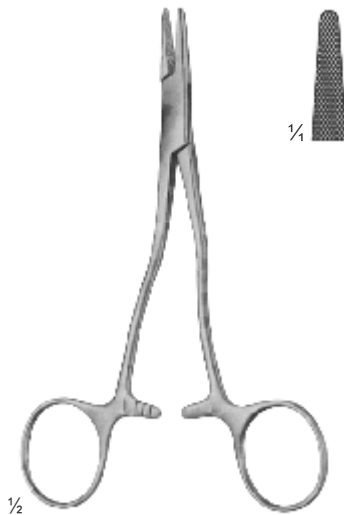

¼

½

KILNER
CM08-003
13.5 cm



¼

½

ADSON
CM08-004
17.5 cm

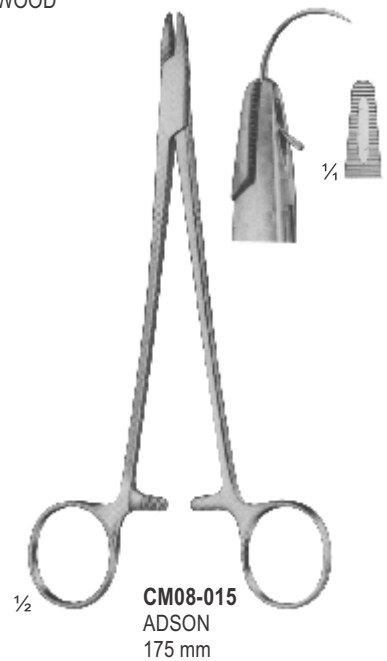
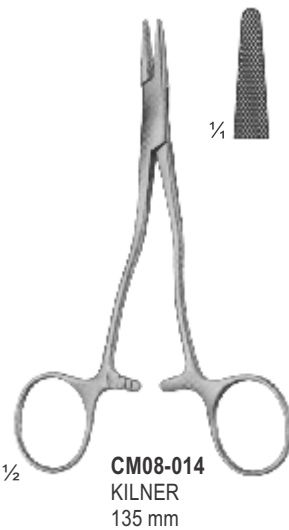
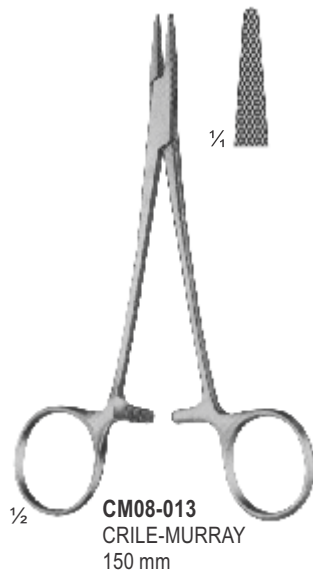
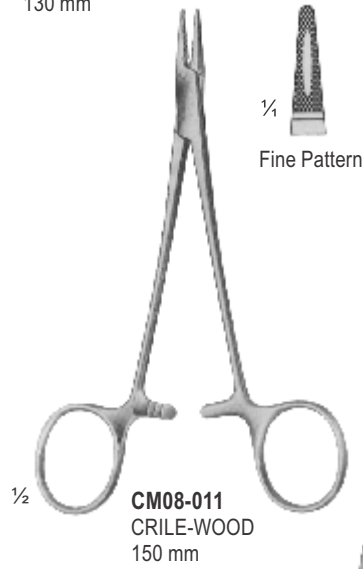
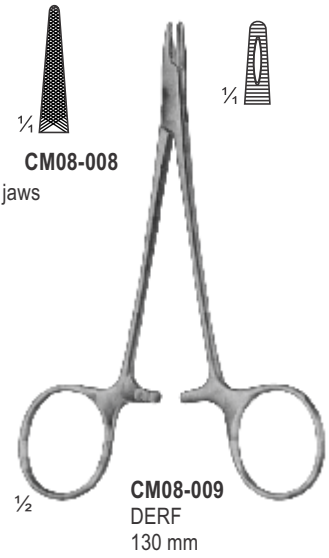
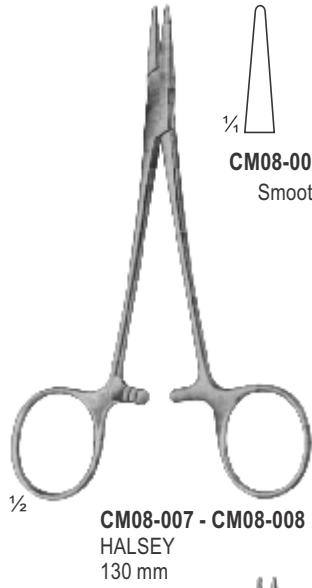
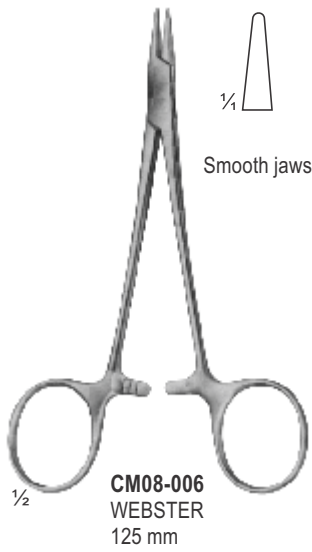

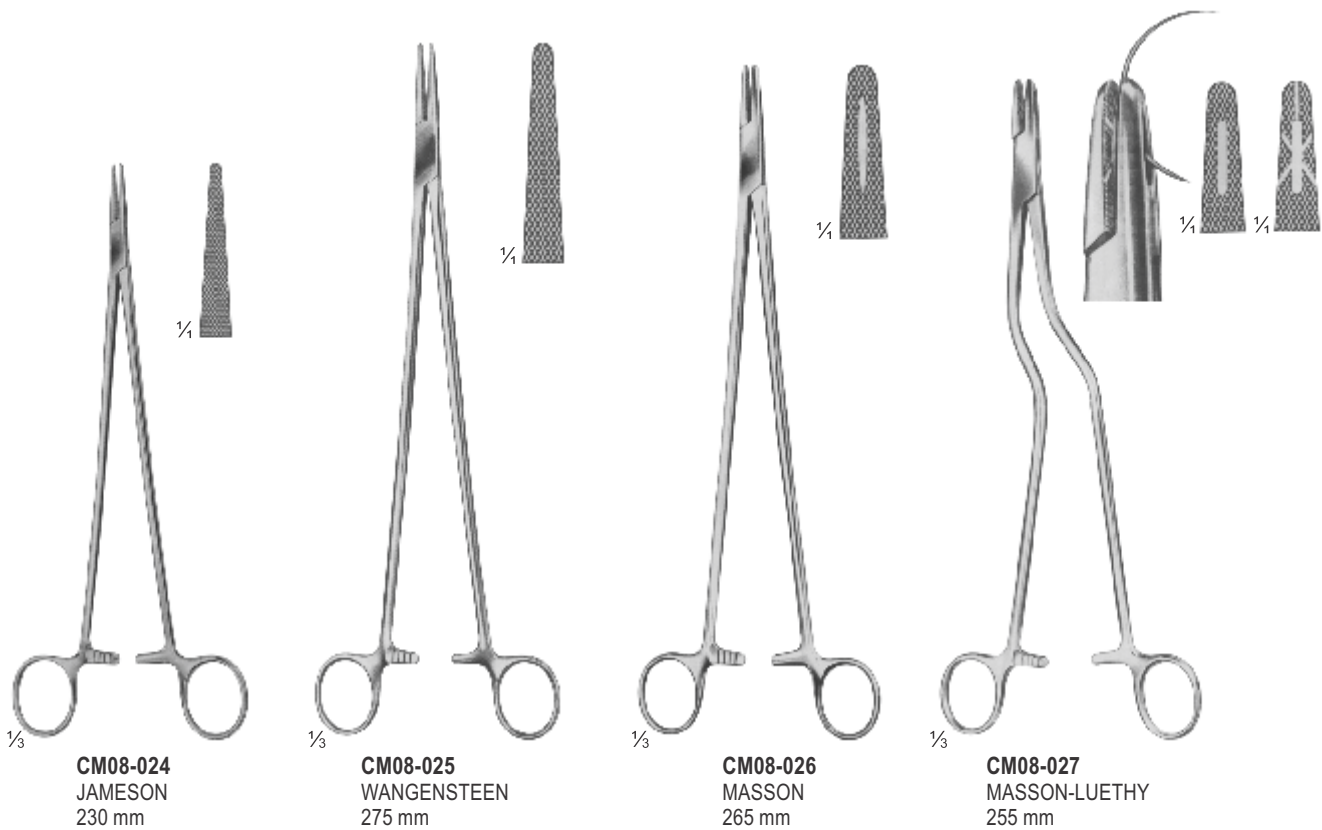

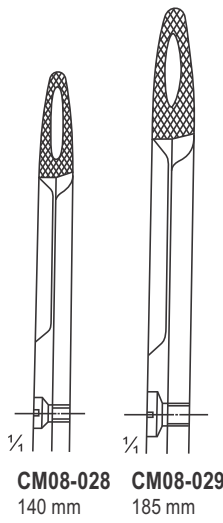
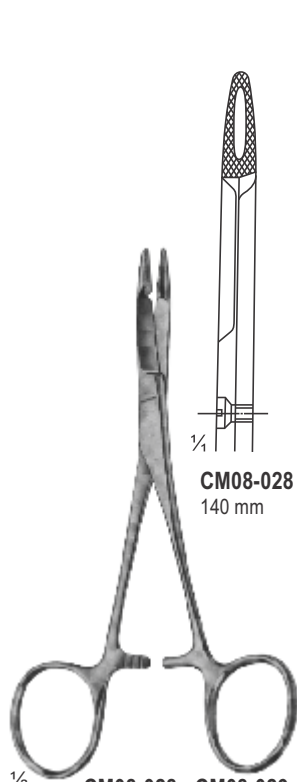

$\frac{1}{2}$ **CM08-028 - CM08-029**
HEGAR-OLSEN
255 mm

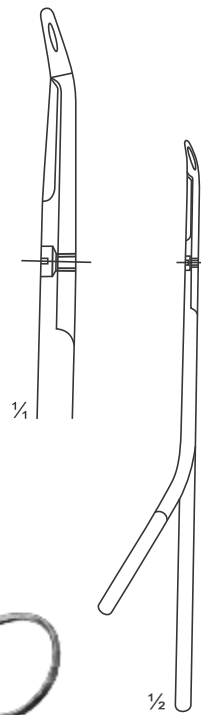
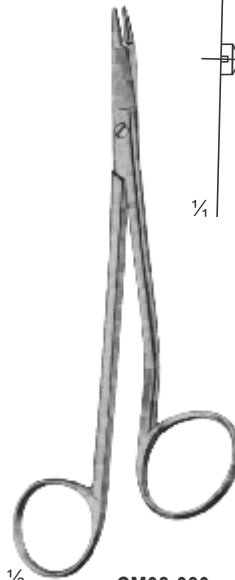
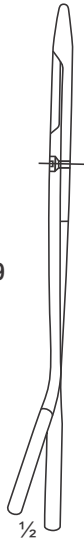

$\frac{1}{2}$ **CM08-030**
GILLIES
150 mm

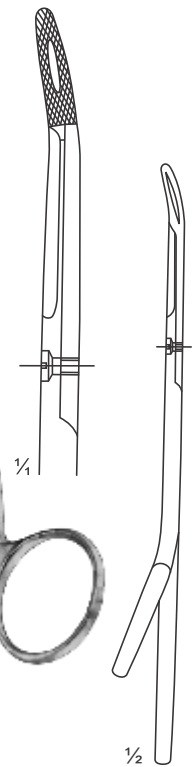
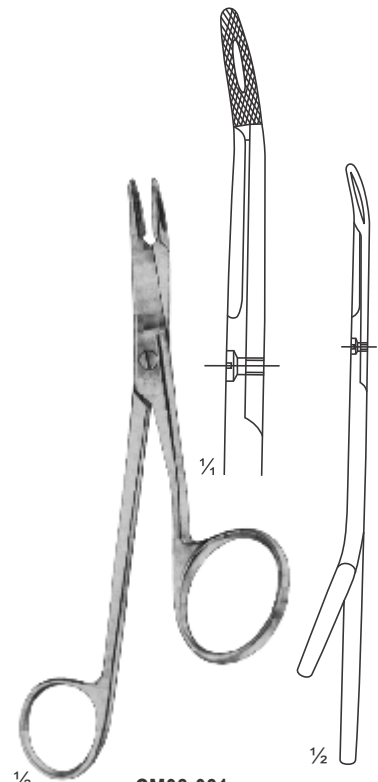

$\frac{1}{2}$ **CM08-031**
GILLIES
160 mm

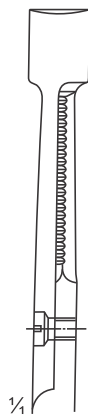
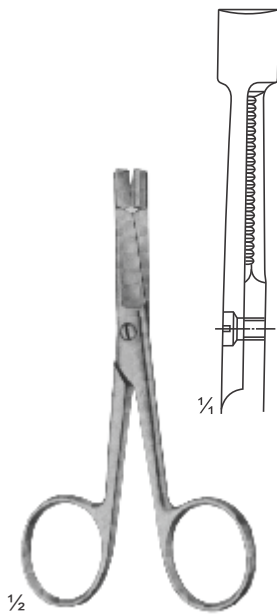

$\frac{1}{2}$ **CM08-032**
EISELSBERG
115 mm

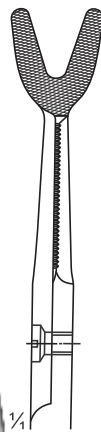
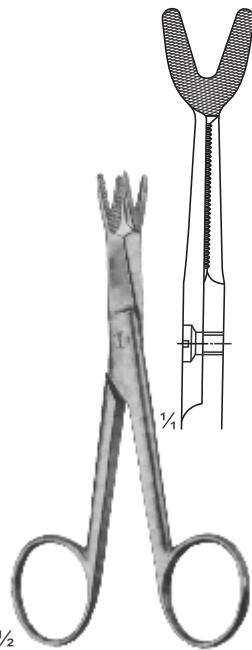

$\frac{1}{2}$ **CM08-033**
SCHOEMAKER-LOTH
125 mm



$\frac{1}{2}$ **CM08-034**
CRILE
150 mm



$\frac{1}{2}$ **CM08-035**
TOENNIS
Elastic pattern for
dura-or intestinal suture
180 mm

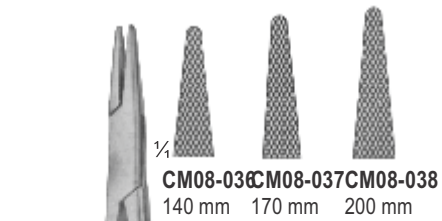

CM08-036 - CM08-038
MATHIEU
140 mm 170 mm 200 mm

1/2
CM08-036 - CM08-038
MATHIEU

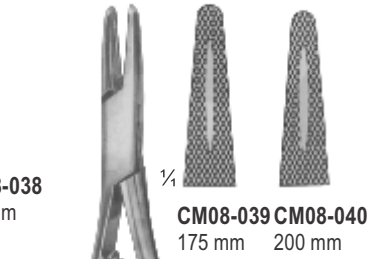

CM08-039 - CM08-040
MATHIEU-STILLE
Very heavy models
175 mm 200 mm

1/2
CM08-039 - CM08-040
MATHIEU-STILLE
Very heavy models



1/2
CM08-041
BOYNTON
125 mm



1/2
CM08-042
EISELSBERG-MATHIEU
For palate suture
195 mm



CM08-043
MATHIEU-KOCHER



CM08-044
BOYNTON
125 mm



1/2
CM08-045
MILLIN
Ligature holding forceps
245 mm



CM08-046 - CM08-049
REVERDIN
140 mm



CM08-046



CM08-047



CM08-048



CM08-049

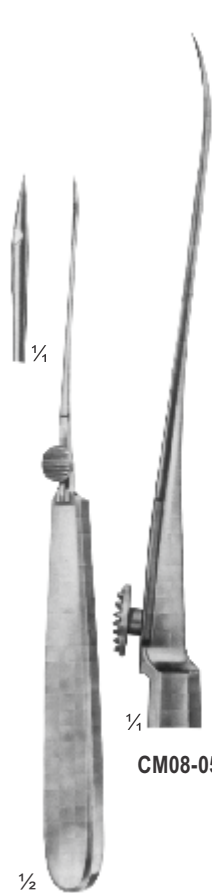

CM08-050 - CM08-053
REVERDIN
195 mm



CM08-050



CM08-051



CM08-052



CM08-053



CM08-054 - CM08-057
REVERDIN
220 mm



CM08-054



CM08-055



CM08-056



CM08-057

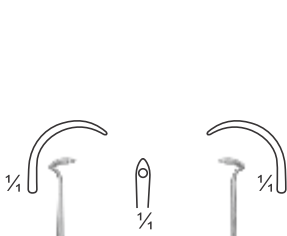

CM08-058
KRONECKER
for right hand
blunt
155 mm

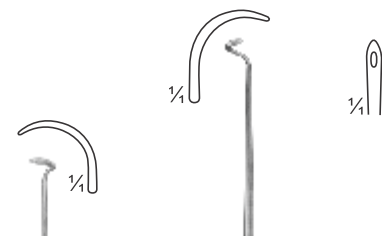

CM08-059
KRONECKER
for left hand
blunt
155 mm

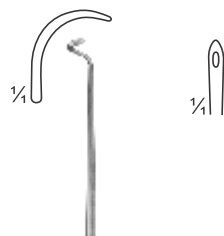

CM08-060
DESCHAMPS
for right hand
steep turn
225 mm

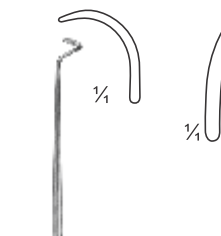

CM08-061
DESCHAMPS
for left hand
steep turn
225 mm

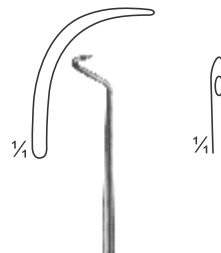

CM08-062
DESCHAMPS
for right hand
steep turn blunt
225 mm

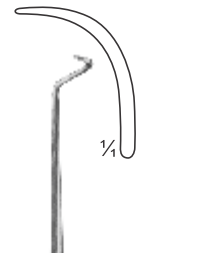

CM08-063
DESCHAMPS
for left hand
steep turn blunt
225 mm

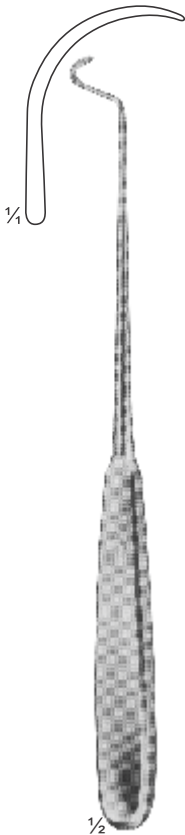

CM08-064
DESCHAMPS
for right hand
steep turn blunt
230 mm

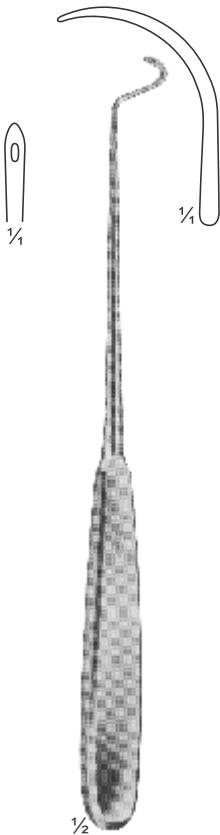

CM08-065
DESCHAMPS
for left hand
steep turn blunt
230 mm

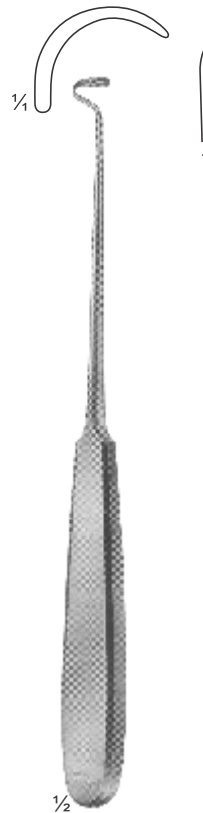

CM08-066
DESCHAMPS
for right hand blunt
215 mm

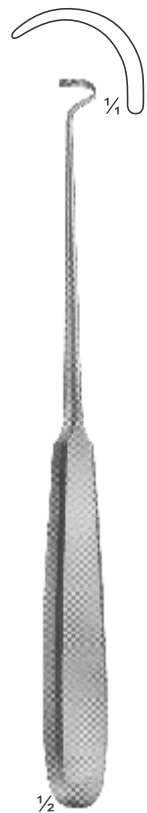

CM08-067
DESCHAMPS
for left hand blunt
215 mm



CM08-068
DESCHAMPS
for right hand blunt
215 mm



CM08-069
DESCHAMPS
for left hand blunt
215 mm

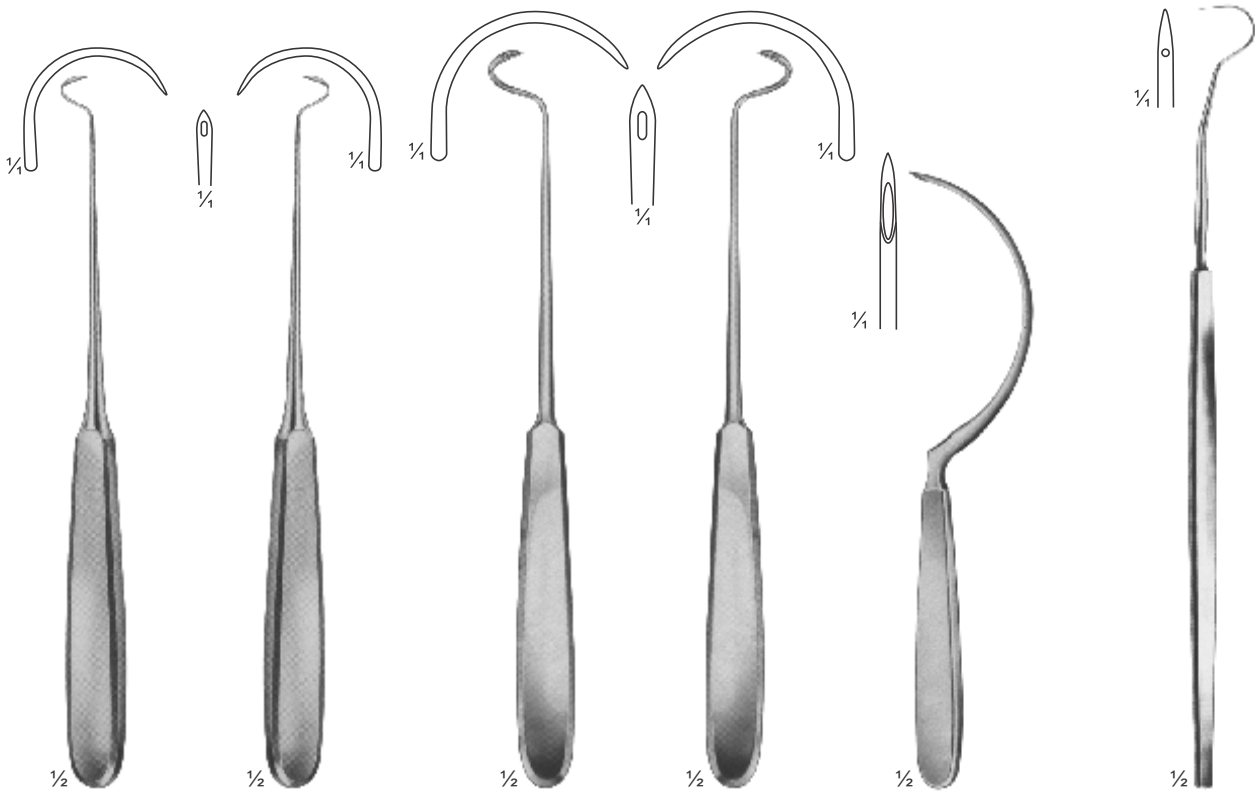

CM08-070
HURD
for right hand
sharp
210 mm

CM08-071
HURD
for left hand
sharp
210 mm

CM08-072
DESCHAMPS
for right hand
sharp
215 mm

CM08-073
DESCHAMPS
for left hand
sharp
215 mm

CM08-074
JONESCO
Needle for wire suture
185 mm

CM08-075
CLAUS VAN EICKEN
Needle for wire suture
250 mm

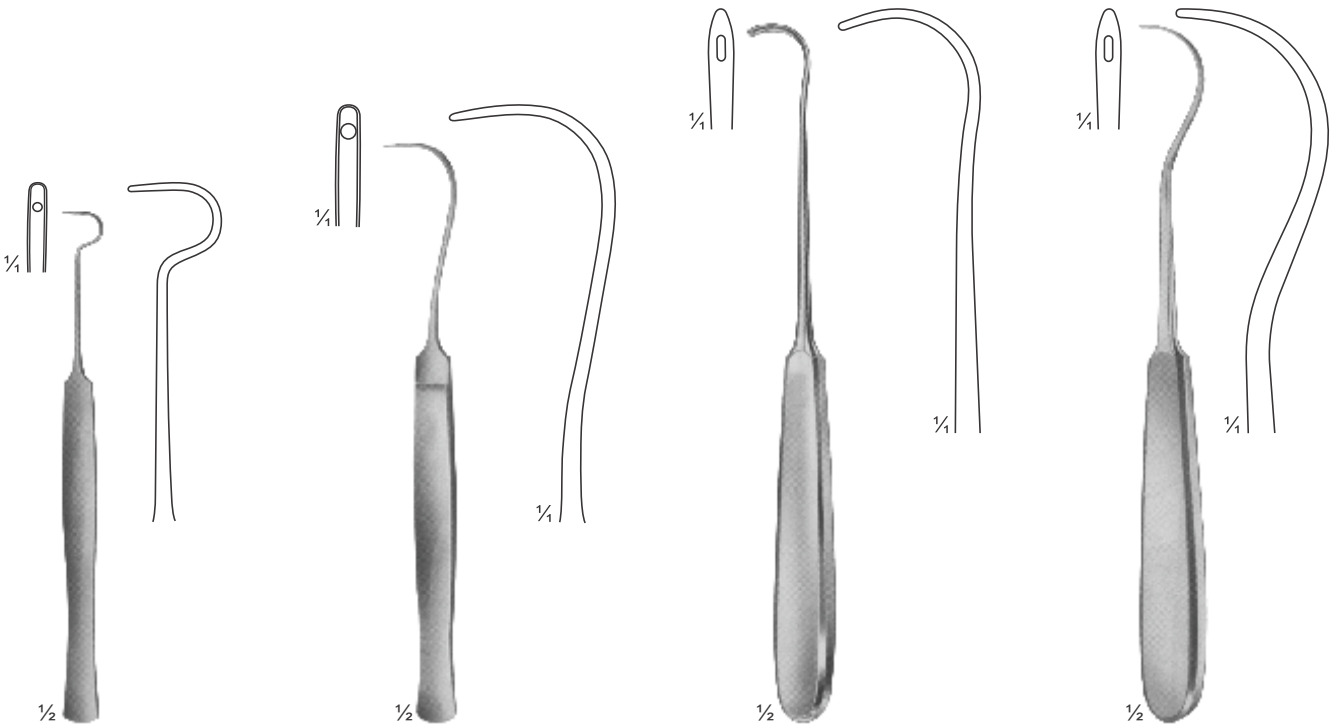

CM08-076
150 mm

CM08-077
SYME
170 mm

CM08-078
COOPER
205 mm

CM08-079
KOCHER
205 mm

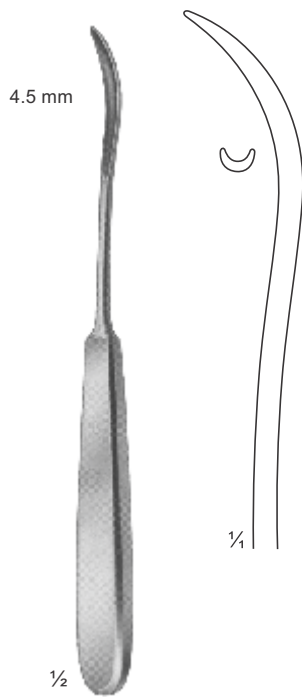

CM08-080
KOENIG
195 mm

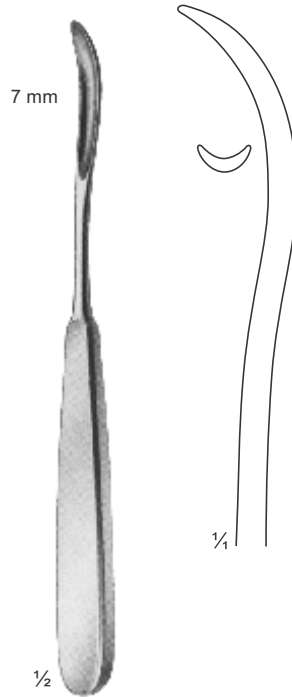

CM08-081
KOENIG
200 mm

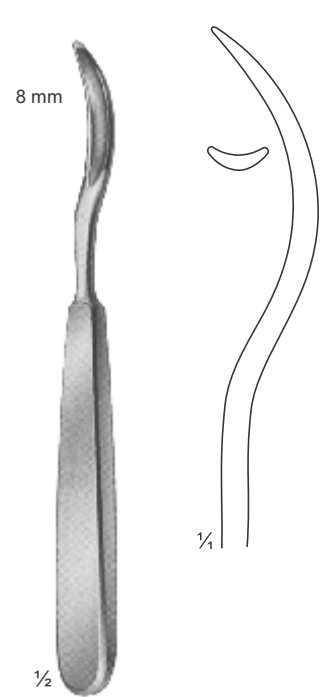

CM08-082
SCHMIEDEN
185 mm

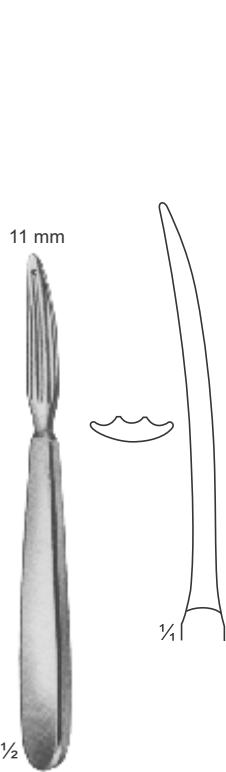

CM08-083
KOCHER
150 mm

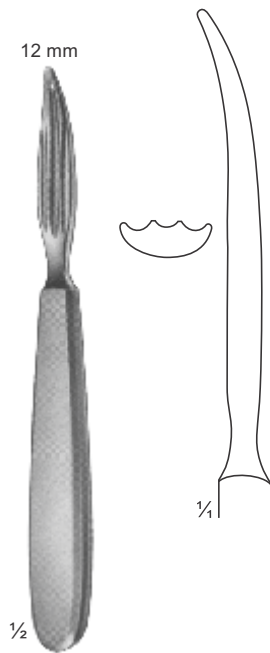

CM08-084
KOCHER
170 mm



CM08-085
PAYR
195 mm

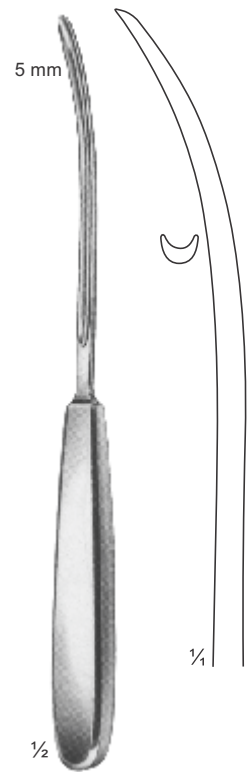

CM08-086
PAYR 225 mm

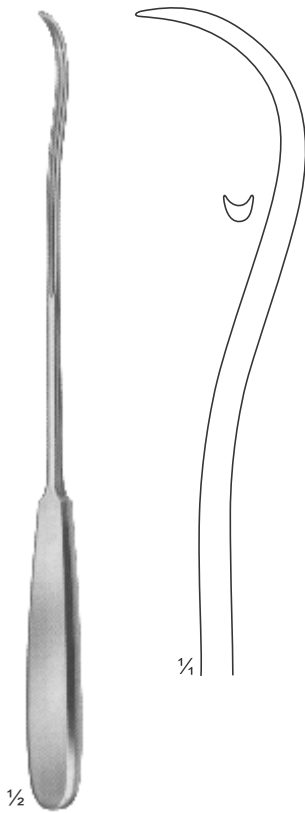

CM08-087
280 mm

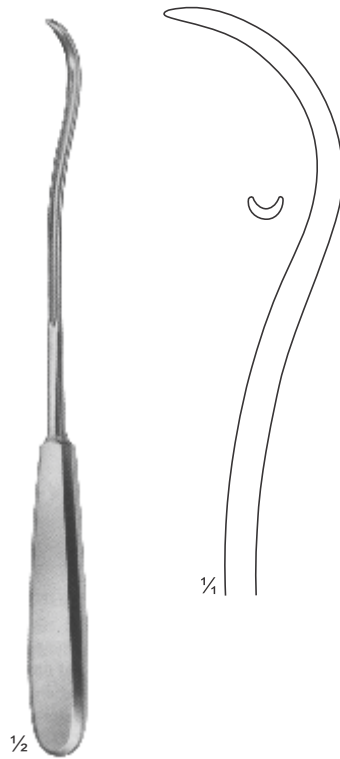

CM08-088
KIRSCHNER
255 mm

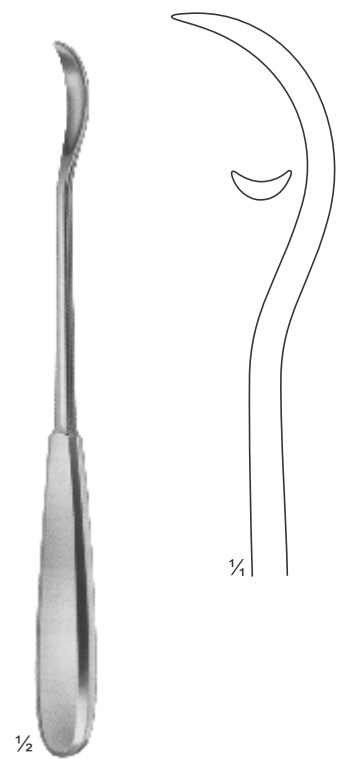

CM08-089
BRUNNER
245 mm



CM08-090
Ligature Adjuster
230 mm



CM08-091
CASPER
Ligature Adjuster
230 mm



CM08-092
WIENER MODEL
Suture hook
235 mm

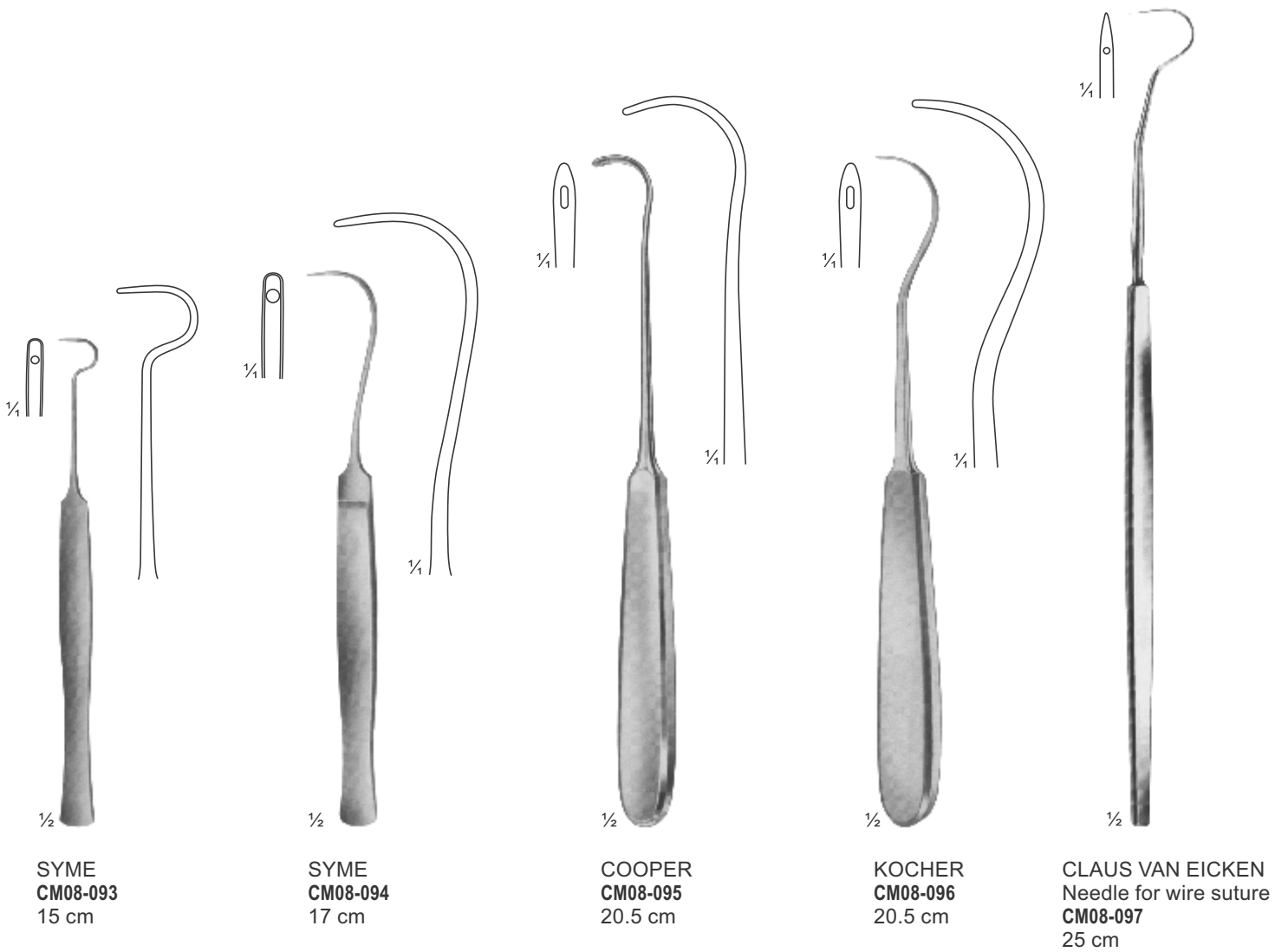

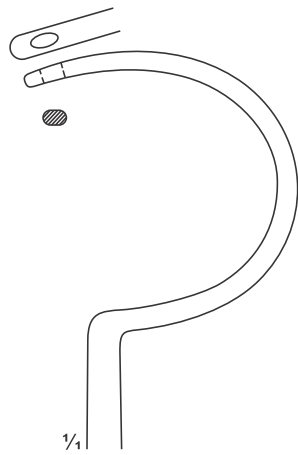

DEMEL
Wire guides
CM08-098 - CM08-100
CM08-098 275 mm
CM08-099 285 mm
CM08-100 305 mm

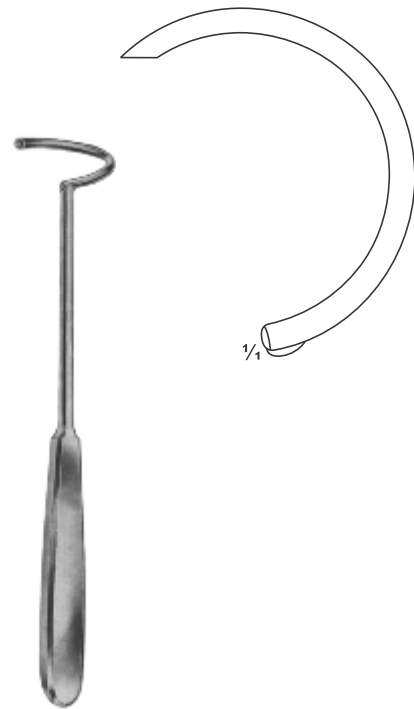

CM08-101
225 mm

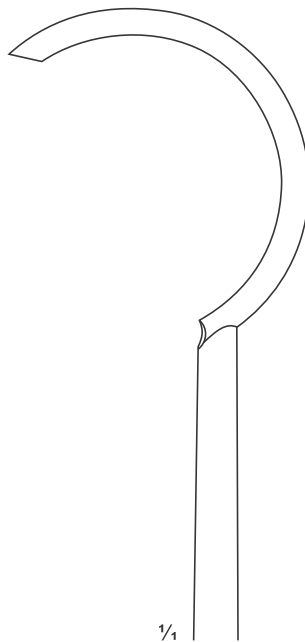

CM08-102 - CM08-103
CM08-102 240 mm
CM08-103 270 mm



KALT
CM08-104
13.5 cm



DIETHRICH
CM08-105 - CM08-109
CM08-105 16 cm
CM08-106 18 cm
CM08-107 20 cm
CM08-108 23 cm
CM08-109 26 cm



WEBSTER
CM08-110
13 cm



DERF
CM08-111
12 cm



HEGAR-BAUMGARTNER
CM08-112 - CM08-113
CM08-112 12.5 cm
CM08-113 14 cm

CM08-112
12.5 cm

CM08-113
14 cm



WEBSTER
CM08-114
13 cm



HALSEY
CM08-115 - CM08-116
13 cm

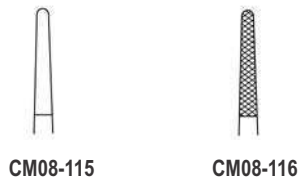

CRILE-WOOD
CM08-117 - CM08-118

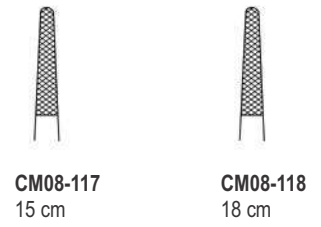

SAROT
CM08-119 - CM08-121





MAYO-HEGAR
CM08-122 - CM08-127
CM08-122 16 cm
CM08-123 18 cm
CM08-124 20 cm
CM08-125 24 cm
CM08-126 26 cm
CM08-127 30 cm



MAYO-HEGAR (HEANEY)
CM08-128 - CM08-130
CM08-128 20 cm
CM08-129 24 cm
CM08-130 26 cm

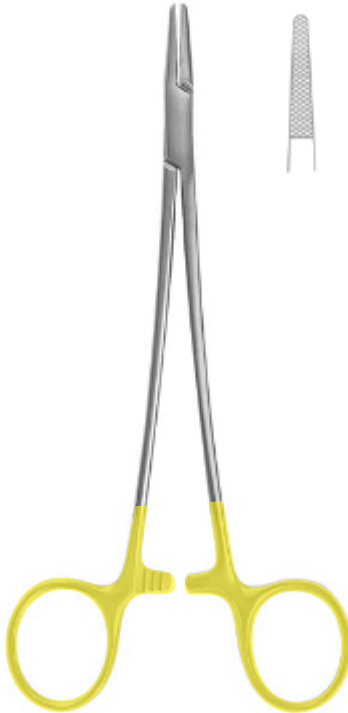

DE BAKEY
CM08-131 - CM08-136
CM08-131 18 cm
CM08-132 20 cm
CM08-133 23 cm
CM08-134 26 cm
CM08-135 31 cm
CM08-136 37 cm



RYDER-VASCULAR
CM08-137 - CM08-142
CM08-137 13 cm
CM08-138 15 cm
CM08-139 18 cm
CM08-140 20 cm
CM08-141 23 cm
CM08-142 26 cm



RYDER
CM08-143 - CM08-148
CM08-143 13 cm
CM08-144 15 cm
CM08-145 18 cm
CM08-146 20 cm
CM08-147 23 cm
CM08-148 26 cm

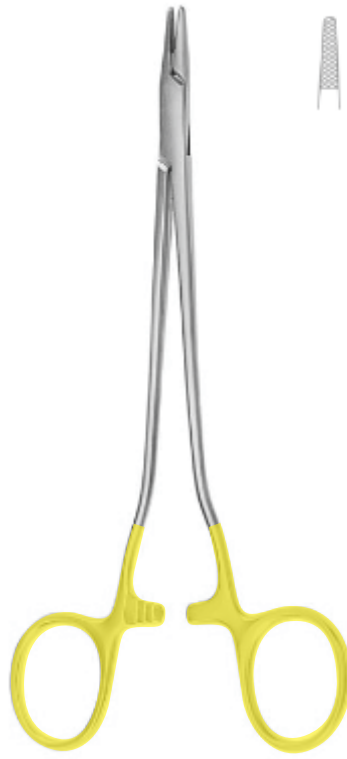

SCHWEDISCHES MODELL
CM08-149 - CM08-151
CM08-149 15 cm
CM08-150 17 cm
CM08-151 20 cm

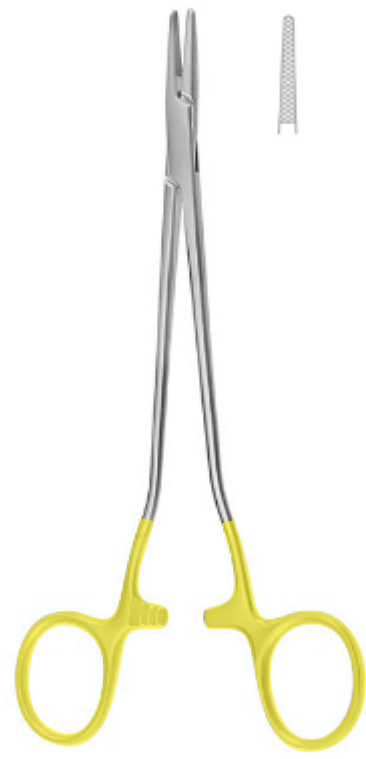

MAYO-HEGAR (HEANEY)
CM08-152 - CM08-155
CM08-152 14 cm
CM08-153 18 cm
CM08-154 20 cm
CM08-155 23 cm



FINOCCHIETTO
CM08-156
 27 cm



MASSON
CM08-157
 27 cm



WANGENSTEEN
CM08-158
 27 cm



BOZEMANN
CM08-159 - CM08-161
CM08-159 20 cm
CM08-160 24 cm
CM08-161 26 cm



BERRY STERNAL
CM08-162 - CM08-163

CM08-162
FOR STERNUM
SUTURE
15 cm

CM08-163
WIRE TWISTER
20 cm



HEGAR
CM08-164 - CM08-165
CM08-164 20 cm
CM08-165 24 cm



STRATTE
CM08-166 - CM08-167
CM08-166 22 cm
CM08-167 23 cm



GILLIES
CM08-168
16 cm



OLSEN-HEGAR
CM08-169 - CM08-171
CM08-169 14 cm
CM08-170 17 cm
CM08-171 18 cm



TOENNIS
CM08-172
18 cm



LICHTENBERG
CM08-173 - CM08-174
CM08-173 17 cm
CM08-174 20 cm



MATHIEU-KOCHER
CM08-175 - CM08-177
CM08-175 14 cm
CM08-176 17 cm
CM08-177 20 cm



MATHIEU
CM08-178 - CM08-180
CM08-178 14 cm
CM08-179 17 cm
CM08-180 20 cm



MATHIEU
CM08-181 - CM08-183
CM08-181 14 cm
CM08-182 17 cm
CM08-183 20 cm



ZWEIFEL
CM08-184 - CM08-185
CM08-184 20 cm
CM08-185 23 cm



LANGENBECK
CM08-186 - CM08-188
CM08-186 18 cm
CM08-187 20 cm
CM08-188 23 cm



CASTROVIEJO
CM08-189 - CM08-192
14.5 cm



CM08-189



CM08-190



CM08-191



CM08-192



CASTROVIEJO
CM08-193 - CM08-196
18 cm



CM08-193



CM08-194



CM08-195



CM08-196



BARRAQUER
CM08-197 - CM08-200
14.5 cm



CM08-197



CM08-198



CM08-199



CM08-200



HEPP SCHEIDEL
CM08-201
18 cm



CARE MEDICAL[®]
S U P P L I E S

Your health _ Our Priority

Section

09

Page 146-152

Probes - Spatulas - Cotton Applicators
Cotton Applicators
Clip Applying Forceps
Redon - Guide Needles
Vein Strippers

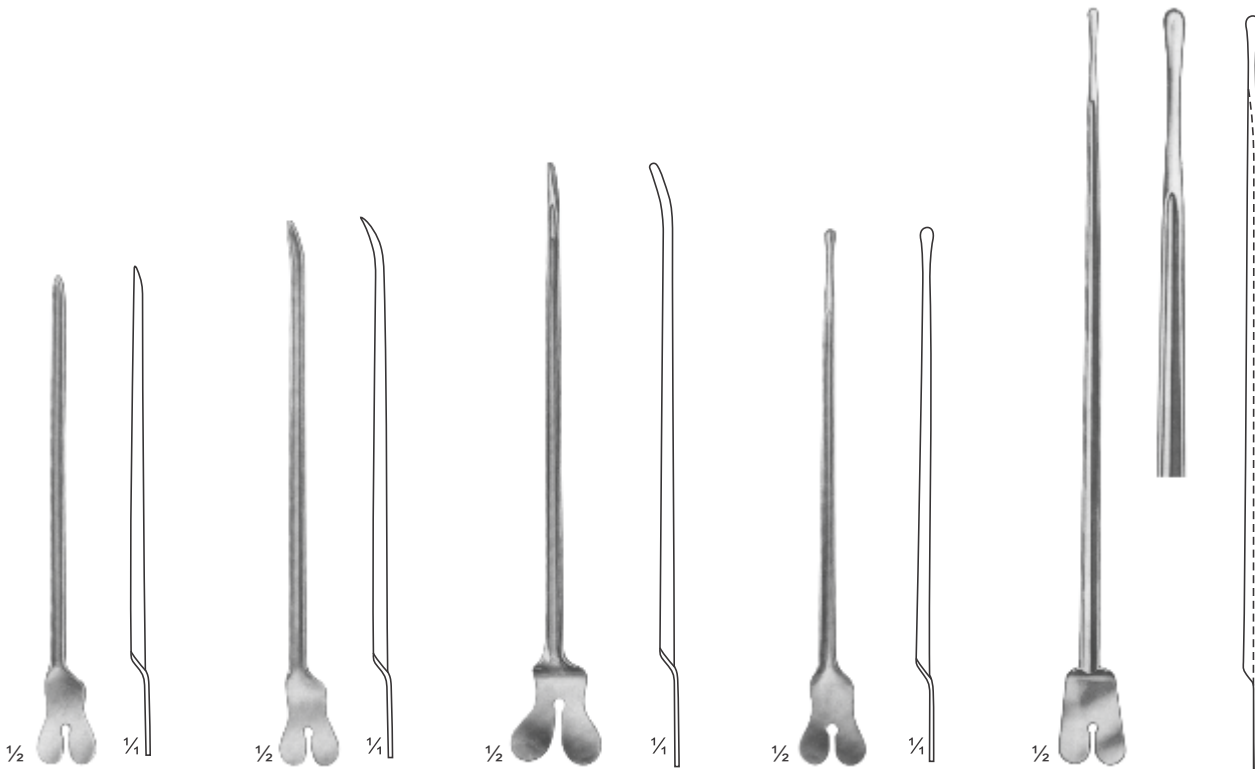

CM09-001 130 mm
CM09-002 145 mm
CM09-003 160 mm
Directors

CM09-004
DOYEN
145 mm
Directors

CM09-005
NELATON
160 mm
Directors

CM09-006
Director with tip
Diam. Of tip 3,3 mm
140 mm

CM09-007
BRODIE
Director with tip,
Diam. Of tip 3,5 mm
200 mm



CM09-008
2,5 mm
CM09-009
2,5 mm
CM09-010
3,0 mm

CM09-008 145 mm
CM09-009 160 mm
CM09-010 200 mm
Probes with eye



1.5 mm

CM09-011
Myrtle leaf probe
145 mm



2 mm

CM09-012 130 mm
CM09-013 145 mm
CM09-014 160 mm
CM09-015 180 mm
CM09-016 200 mm



1/2

CM09-017
Probes



1/2

CM09-018
Double ended probe,
malleable, diam. of tips
3 mm with hole
190 mm



CM09-019
Double ended probes,
tin, malleable,
diam. of tips
3,5 mm with hole
250 mm, 300 mm



1/4

CM09-020
Double ended probes,
tin, malleable,
diam. of tips 4 mm
400 mm



1/3

CM09-021 1,5 mm
CM09-022 2,0 mm
CM09-023 2,5 mm
300 mm



CM09-024
STACKE
100 mm



CM09-025
KILLIAN
165 mm



CM09-026
160 mm



CM09-027
SEIFFERT
180 mm



CM09-028
BOWMAN
130 mm

German Silver



CM09-029
SPATULA
145 mm



CM09-030
SPATULA
145 mm



CM09-031
Modell PICCOLO
Round Serrated
110 mm



CM09-032
Modell PICCOLO
Triangular Serrated end
110 mm



CM09-033
FARRELL
Round Serrated end
110 mm



CM09-034
LATHBURY-FARRELL
Triangular Serrated end
110 mm

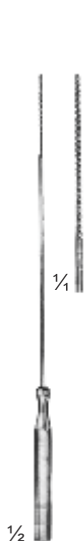

CM09-035
BUCK
Rough, spiral end
120 mm

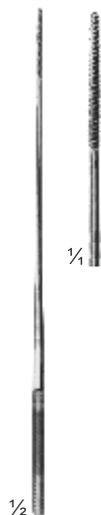

CM09-036
Triangular
serrated end
140 mm

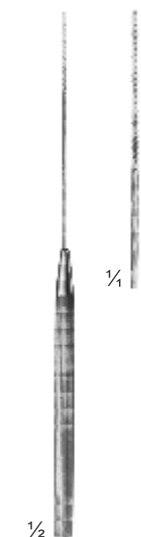

CM09-037
Rough, spiral end
140 mm



CM09-038
Rough, spiral end
140 mm

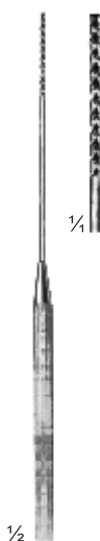

CM09-039
Rough, spiral end
140 mm



CM09-040
FARRELL
Round,
serrated end
140 mm



CM09-041
LATHBURY-FARRELL
Triangular,
serrated end
140 mm

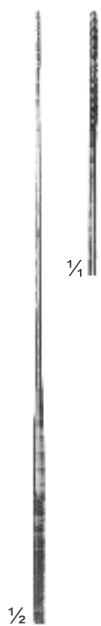

CM09-042
FARRELL
Rough,
spiral end
160 mm



CM09-043
LATHBURY-FARRELL
Triangular,
serrated end
160 mm



CM09-044
Triangular,
serrated end
160 mm

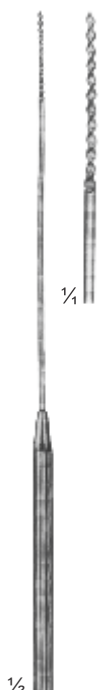

CM09-045
Rough,
spiral end
180 mm



CM09-046
Rough,
spiral end
180 mm



CM09-047
Rough,
spiral end
270 mm



1/2

CM09-048
MICHEL
125 mm



1/2

CM09-049
HEGENBARTH
120 mm



1/2

CM09-050
WACHENFELDT
120 mm



1/2

CM09-051
WACHENFELDT
120 mm



1/2

CM09-052
MICHEL
125 mm



1/2

CM09-053
MICHEL modif.
130 mm



1/2

CM09-054
HEATH
135 mm



1/2

CM09-055
COLLIN
135 mm

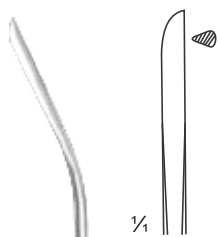

- CM09-056** 8 CH
- CM09-057** 10 CH
- CM09-058** 12 CH
- CM09-059** 14 CH
- CM09-060** 16 CH
- CM09-061** 18 CH

1/2

REDON
CM09-056 - 061
 threaded end
 19.5 cm

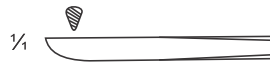

- CM09-062** 8 CH
- CM09-063** 10 CH
- CM09-064** 12 CH
- CM09-065** 14 CH
- CM09-066** 16 CH
- CM09-067** 18 CH

1/2

REDON
CM09-062 - 067
 threaded end
 14 cm



- CM09-068** 8 CH
- CM09-069** 10 CH
- CM09-070** 12 CH
- CM09-071** 14 CH
- CM09-072** 16 CH
- CM09-073** 18 CH

1/2

REDON
CM09-068 - 073
 threaded end
 19.5 cm

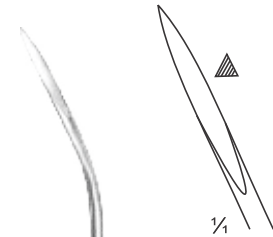

- CM09-074** 8 CH
- CM09-075** 10 CH
- CM09-076** 12 CH
- CM09-077** 14 CH
- CM09-078** 16 CH
- CM09-079** 18 CH

1/2

REDON
CM09-074 - 079
 threaded end
 19.5 cm



NABATOFF
CM09-080
135x100x25 mm



CM09-081



CM09-082
Ø 3 mm



CM09-083
Ø 6 mm



CM09-087



CM09-084
Ø 9 mm



CM09-085
Ø 12 mm



CM09-086
Ø 15 mm

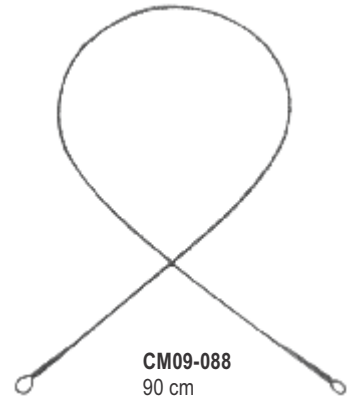

CM09-088
90 cm



MYERS
CM09-089



CM09-090
Ø 6 mm



CM09-091
Ø 9 mm



CM09-092
Ø 12 mm



CM09-093
Ø 15 mm



VARADY
CM09-094



CM09-095



CM09-096



CM09-097

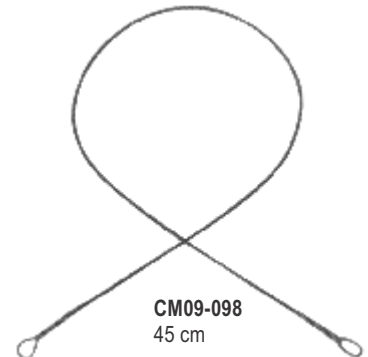

CM09-098
45 cm



CARE MEDICAL[®]
SUPPLIES

Your health _ Our Priority

Section

10

Page 153-187

Abdominal Retractors
Retractors, Lung Spatulas
Hooklets
Retractors For Deep Surgery
Pelvis Retractors
Abdominal- And Intestinal Spatulas
Retractors, Deep Form
Retractors

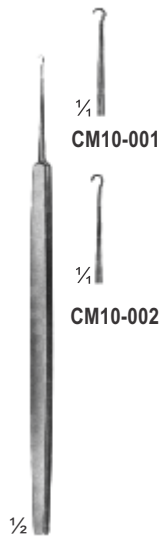

CM10-001 Sharp
CM10-002 Blunt
GRAEFE
125 mm

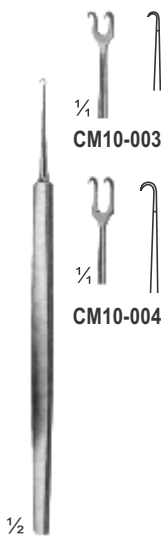

CM10-003 125 mm
CM10-004 130 mm
Sharp
GUTHRIE

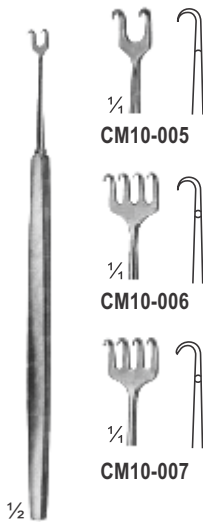

CM10-005 130 mm
CM10-006 135 mm
Sharp
ROLLET
CM10-007 135 mm
Blunt



CM10-008
FRAZIER
Dura Retractors
130 mm

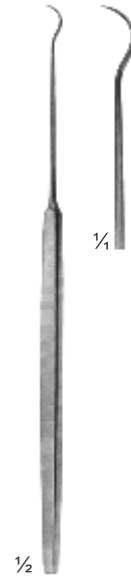

CM10-009
TONNIS
Dura Retractors
150 mm



CM10-010
KILNER
160 mm

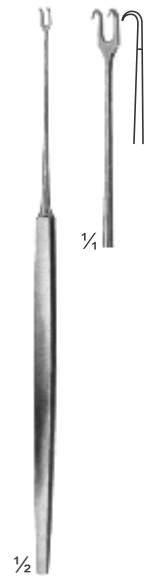

CM10-011
FREER
150 mm

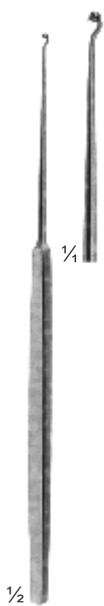

CM10-012
MULLER
150 mm

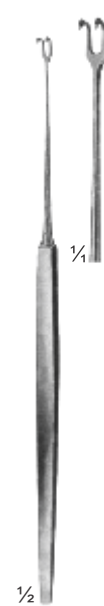

CM10-013
MULLER
150 mm

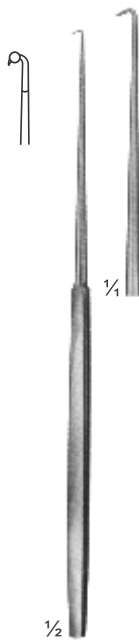

CM10-014
COTTLE
160 mm

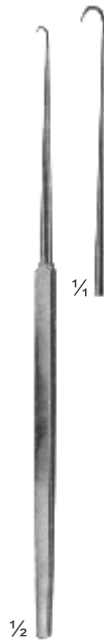

CM10-015
COTTLE
160 mm



CM10-016
JAEGAR
135 mm



CM10-017 - 020
JOSEPH
165 mm



CM10-017

CM10-018
3 mm

CM10-019
6 mm

CM10-020
8 mm



CM10-021

CM10-022

3 X 11 mm

7 X 12 mm

8 X 12 mm

CM10-023
KILNER
Sharp
80 mm



CM10-024
CONVERSE
Blunt
120 mm

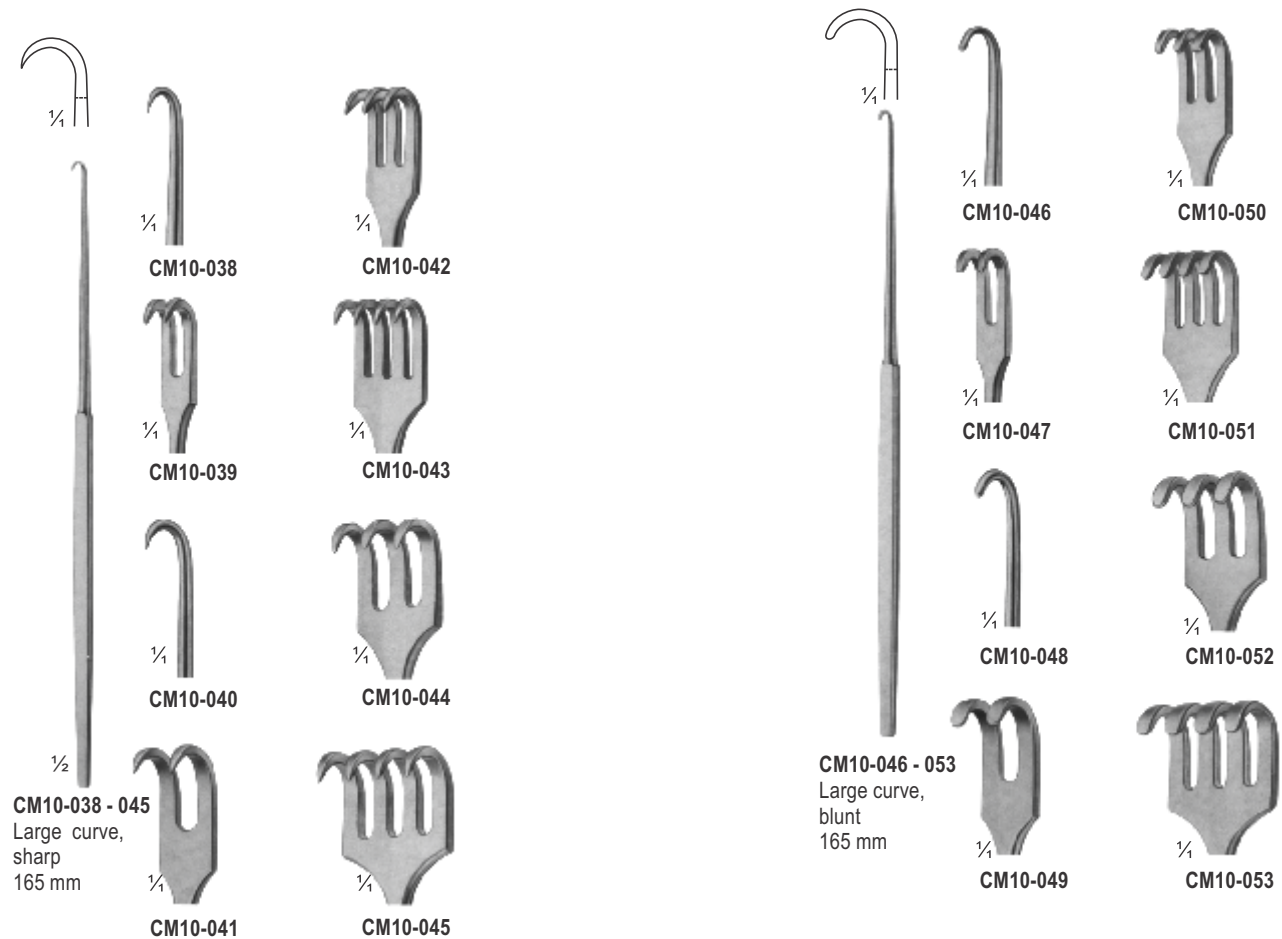
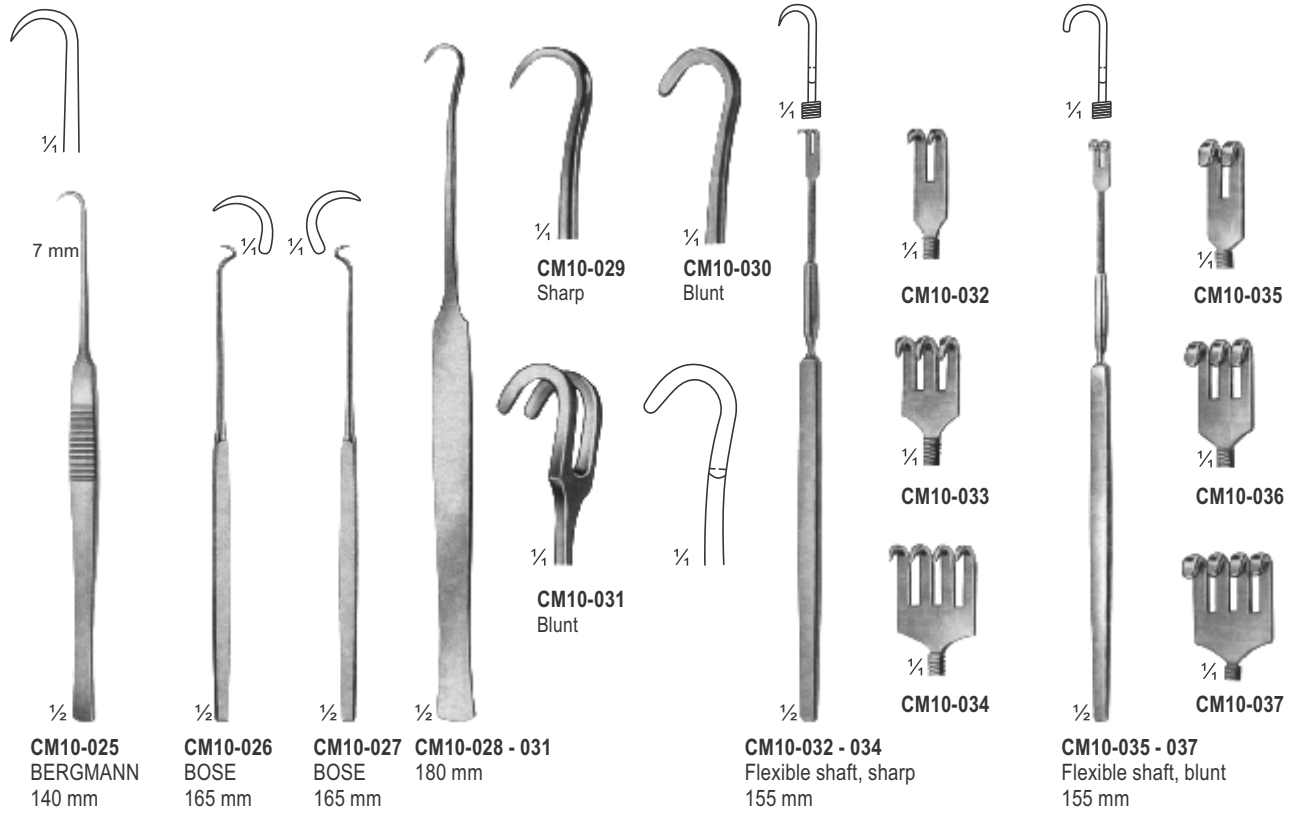

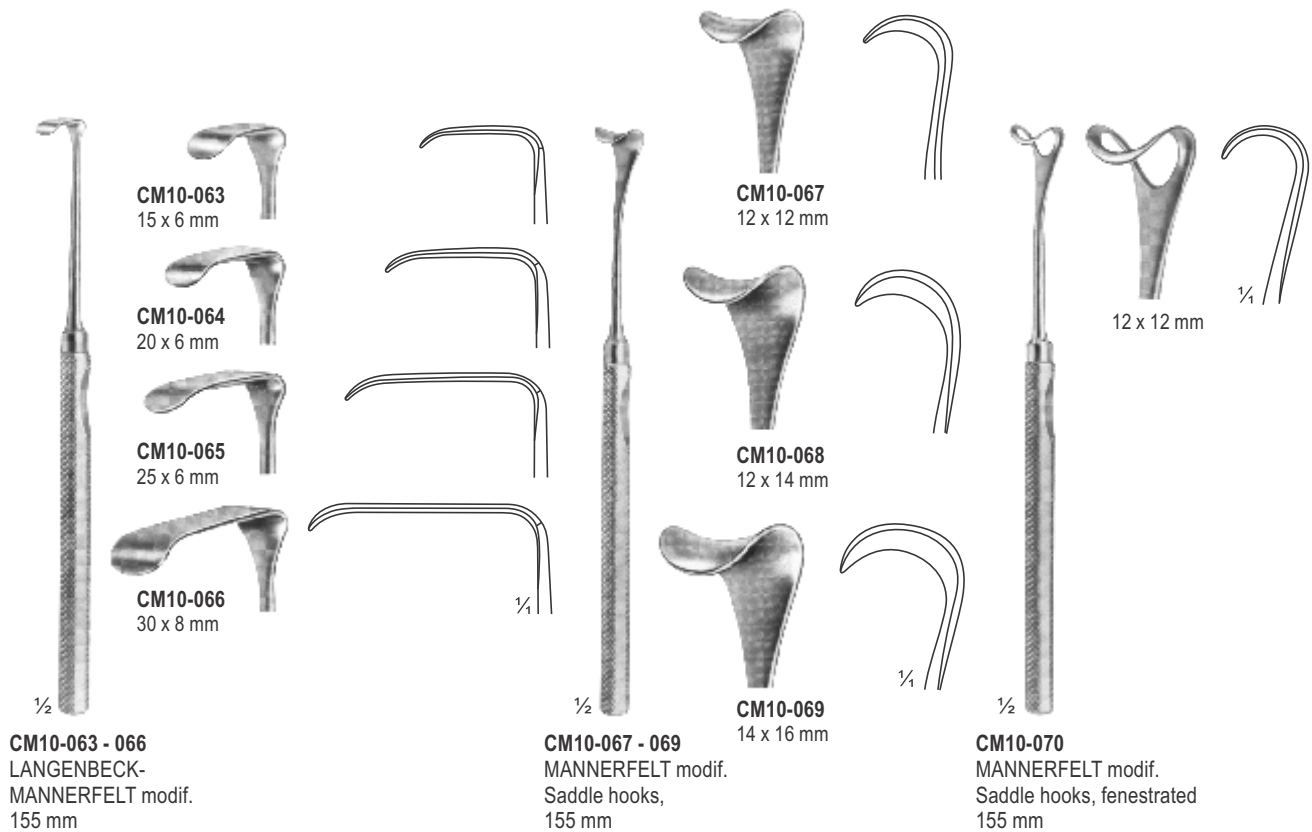
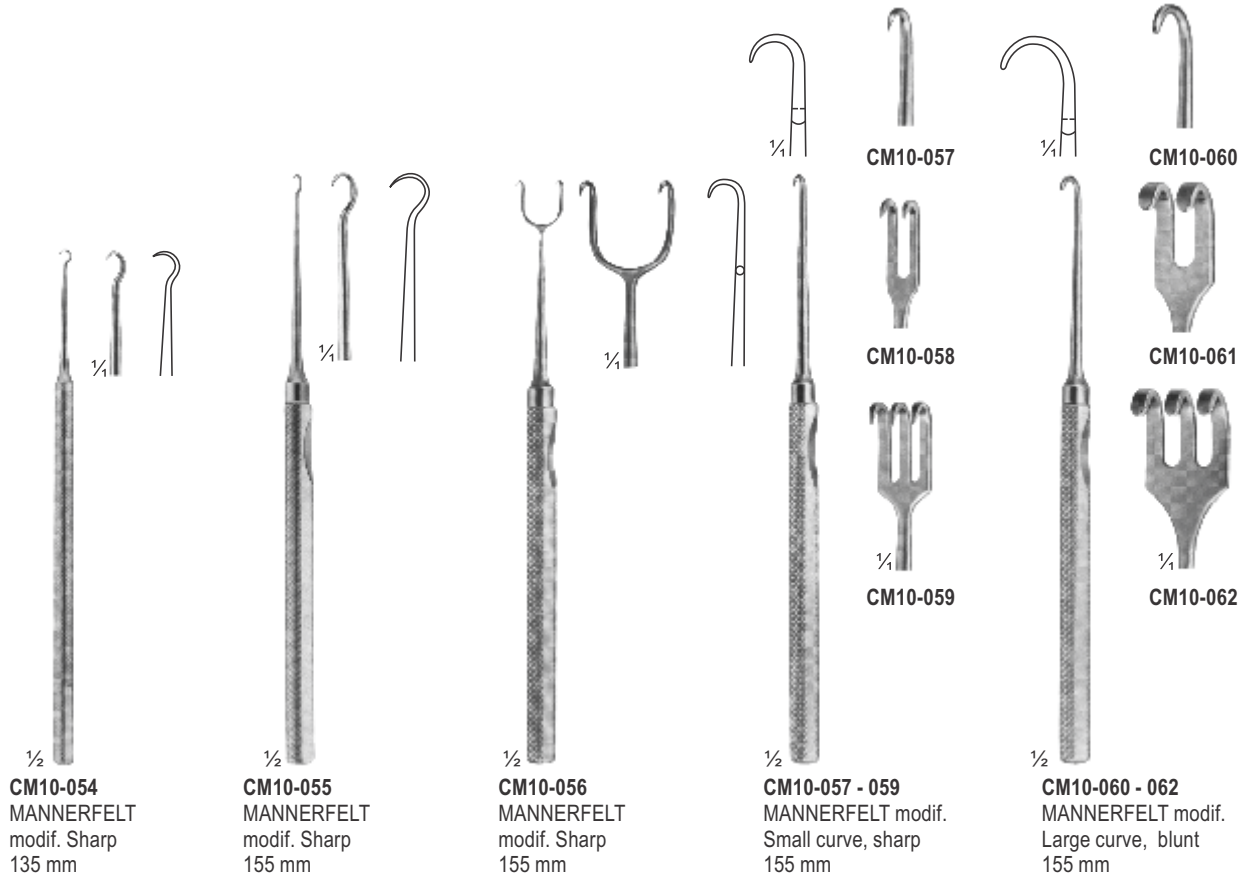

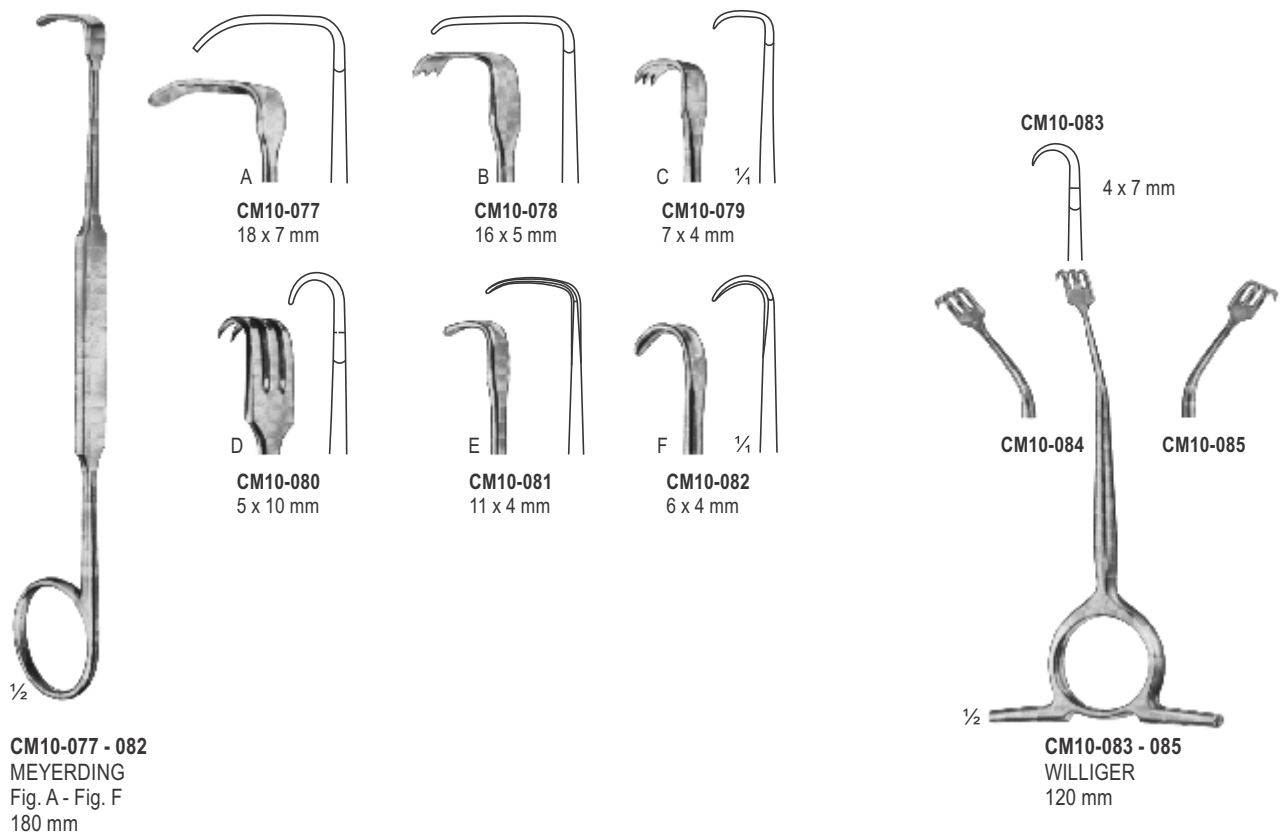
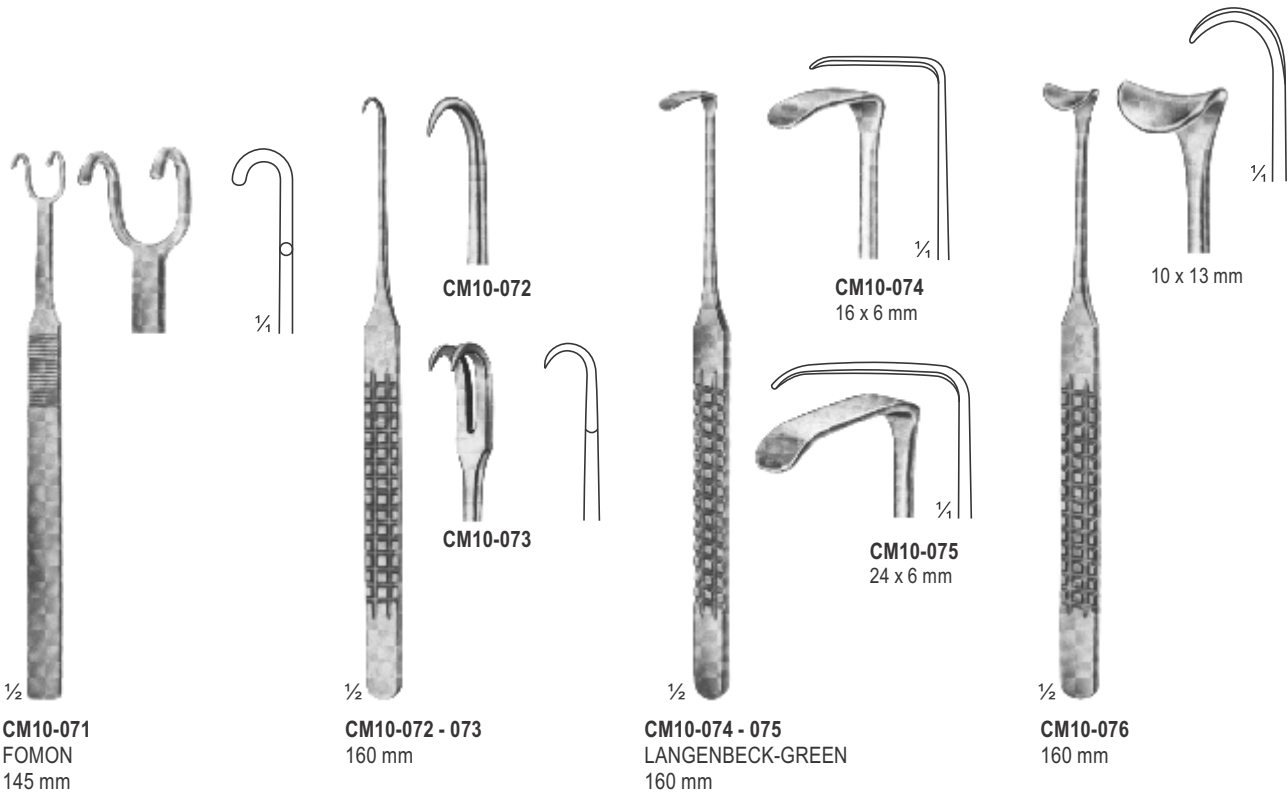



CM10-086
EMMET
Fistula hook
220 mm

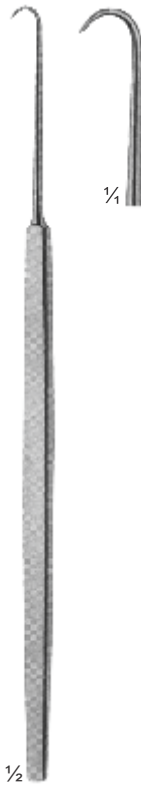

CM10-087
SIMON
Fistula hook
220 mm

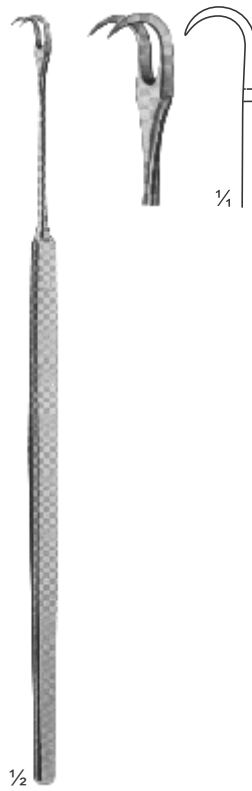

CM10-088
SIMON
Fistula hook
220 mm



CM10-089
LANGE
Fistula hook
230 mm

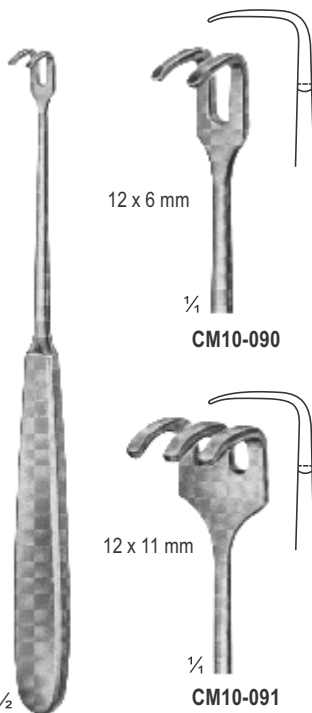

CM10-090 - 091
Tendon hooks
175 mm

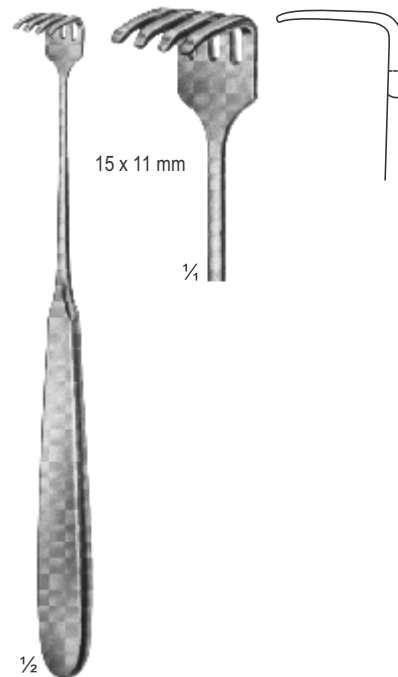

CM10-092
KLAPP
Tendon hooks
175 mm

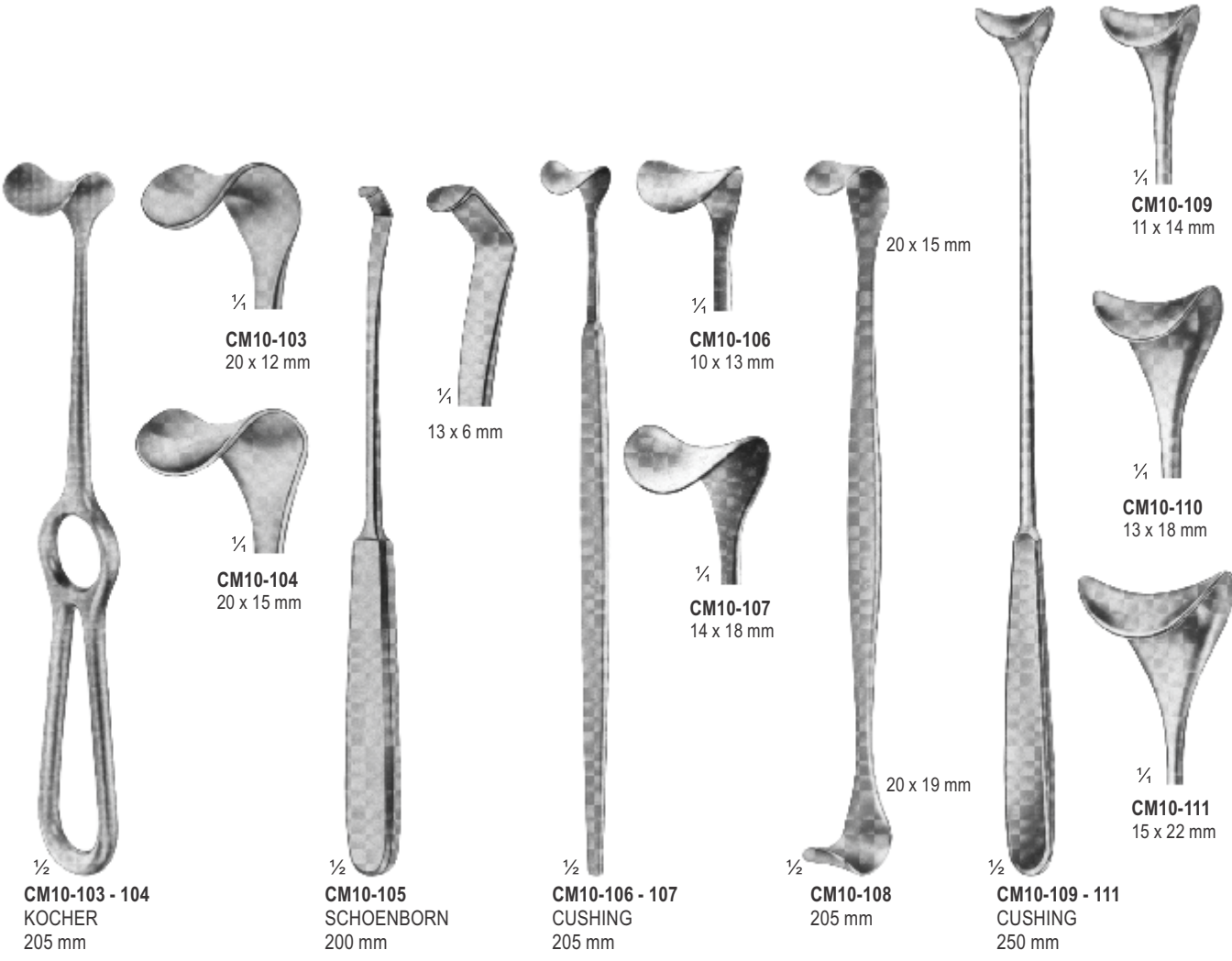
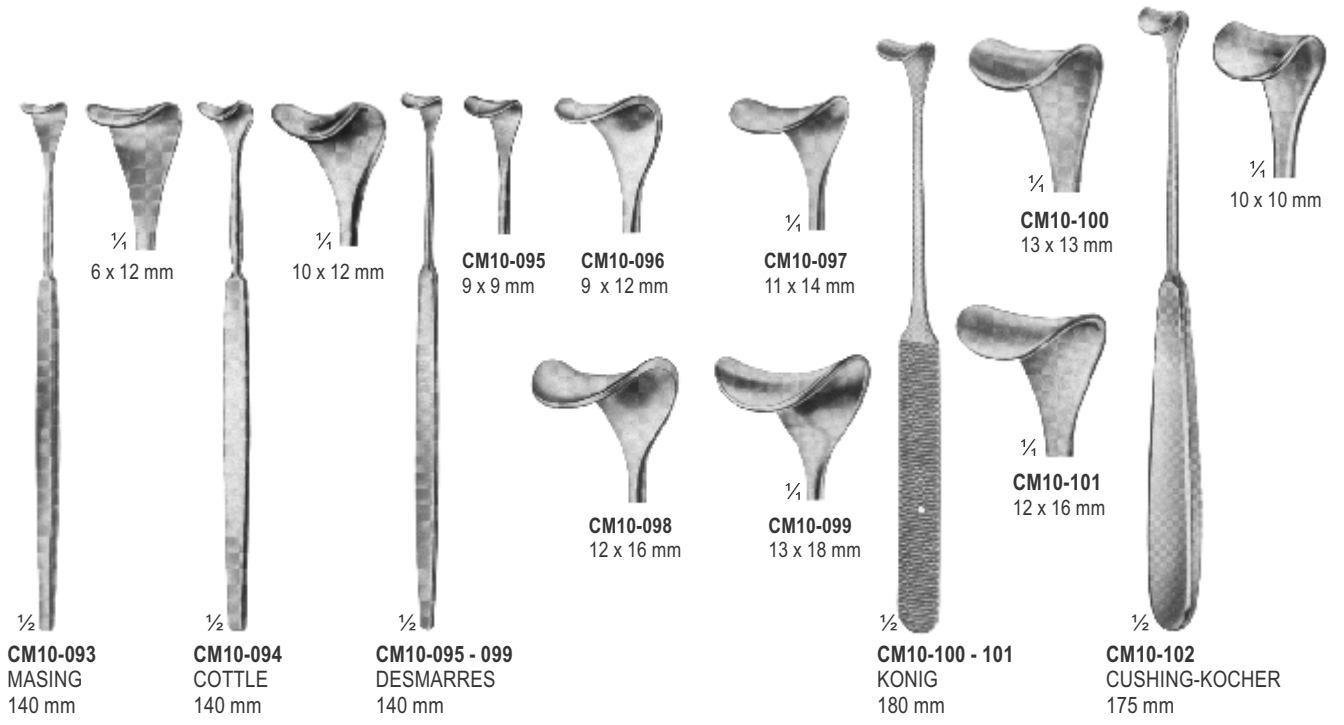

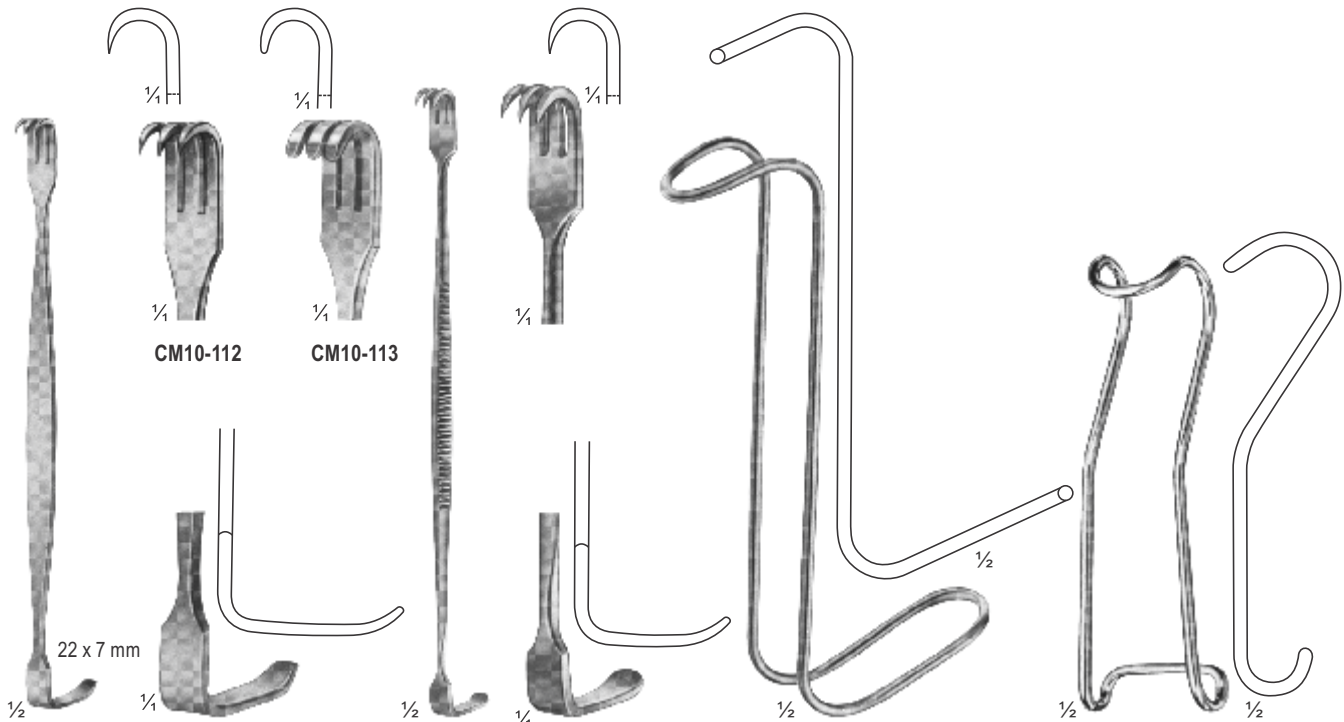

CM10-112 - 113
BABY-SENN-MILLER
155 mm

CM10-114
SENN-MILLER
165 mm

CM10-115
COLLIN-HARTMANN
150 mm

STERBERG
CM10-116 120 mm
CM10-117 130 mm
CM10-118 135 mm
CM10-119 140 mm

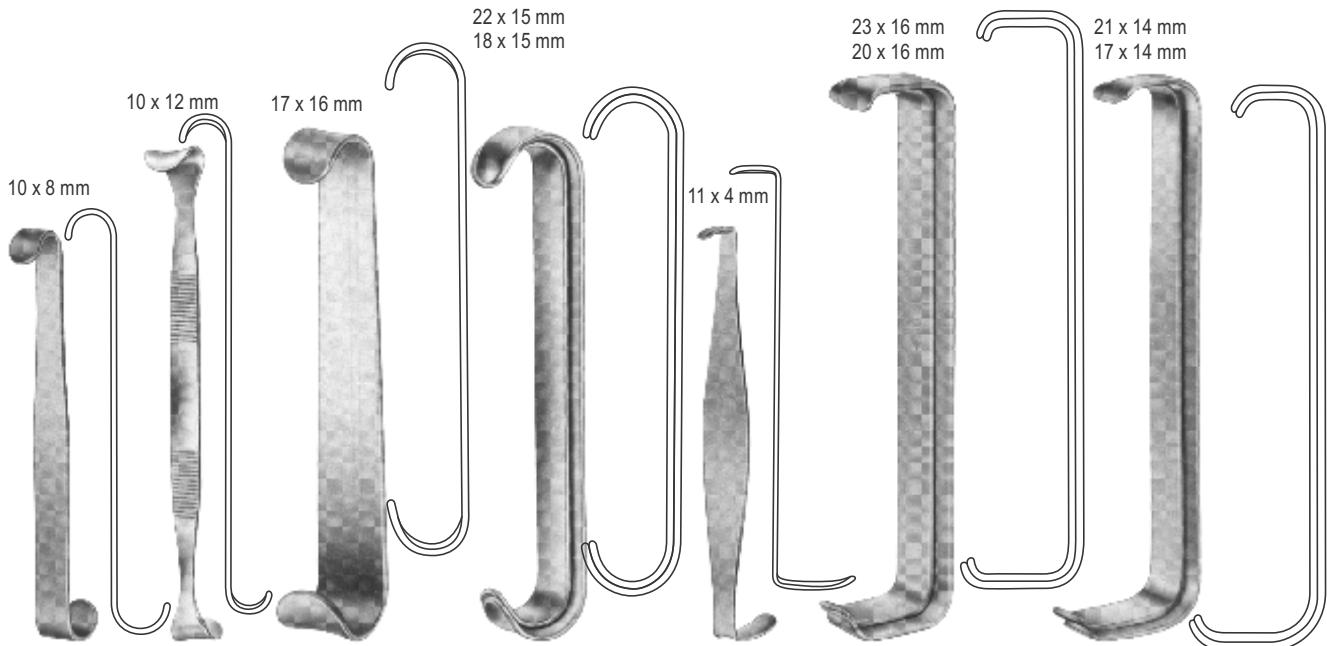

CM10-120
LUER
110 mm

CM10-121
ROSE
130 mm

CM10-122
BABY-ROUX
135 mm

CM10-123
PARKER
135 mm

CM10-124
CRILE
110 mm

CM10-125
FARABEUF
150 mm

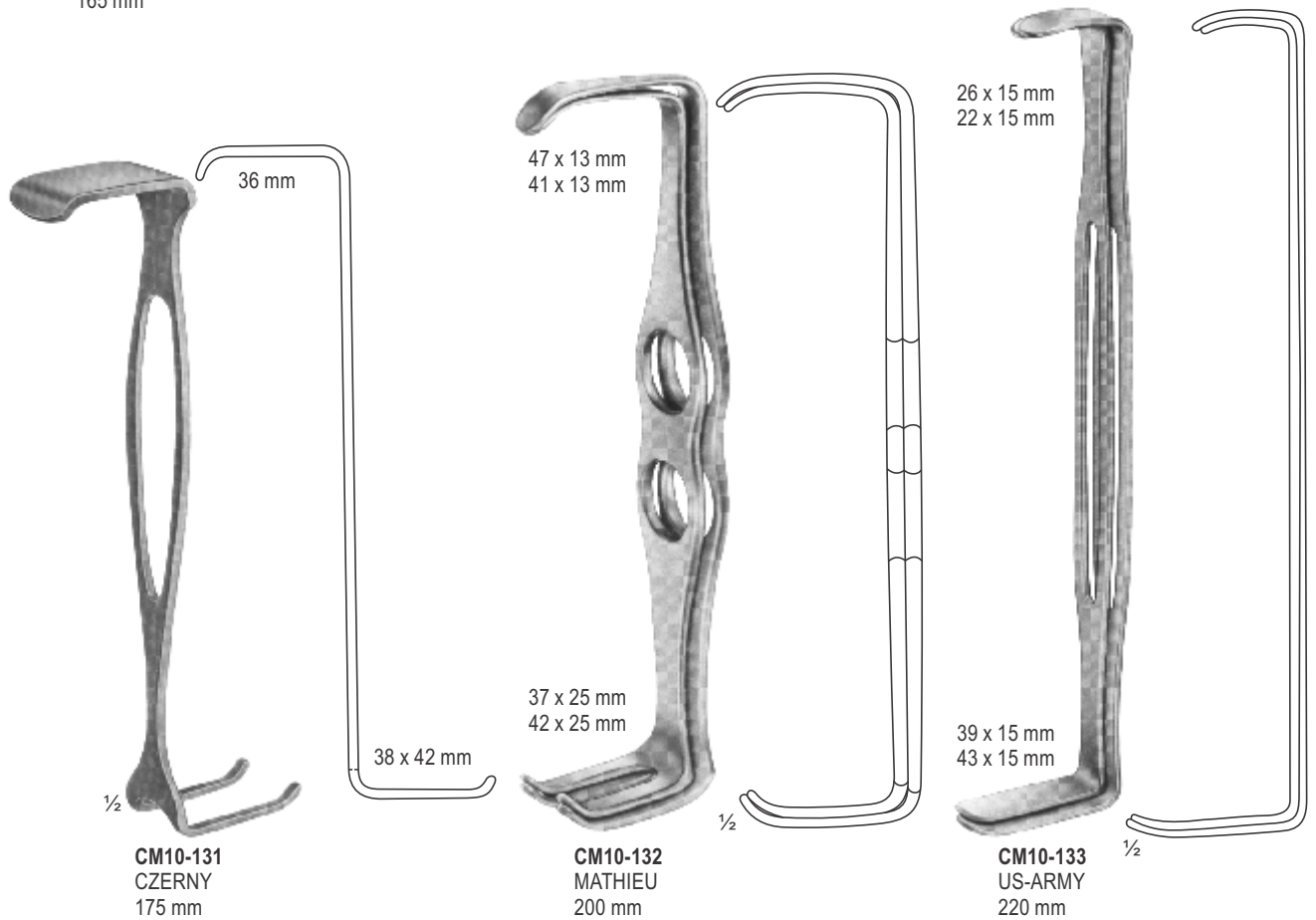
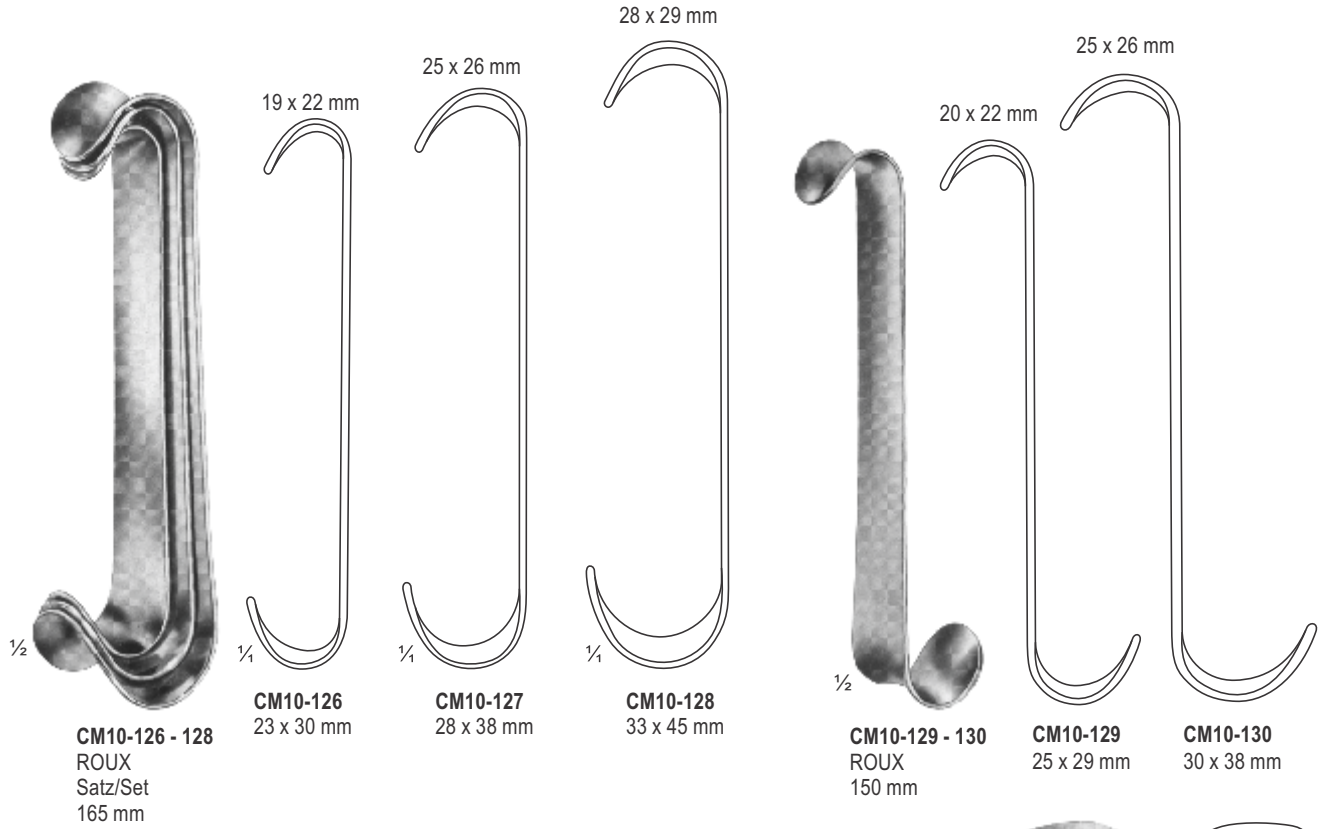

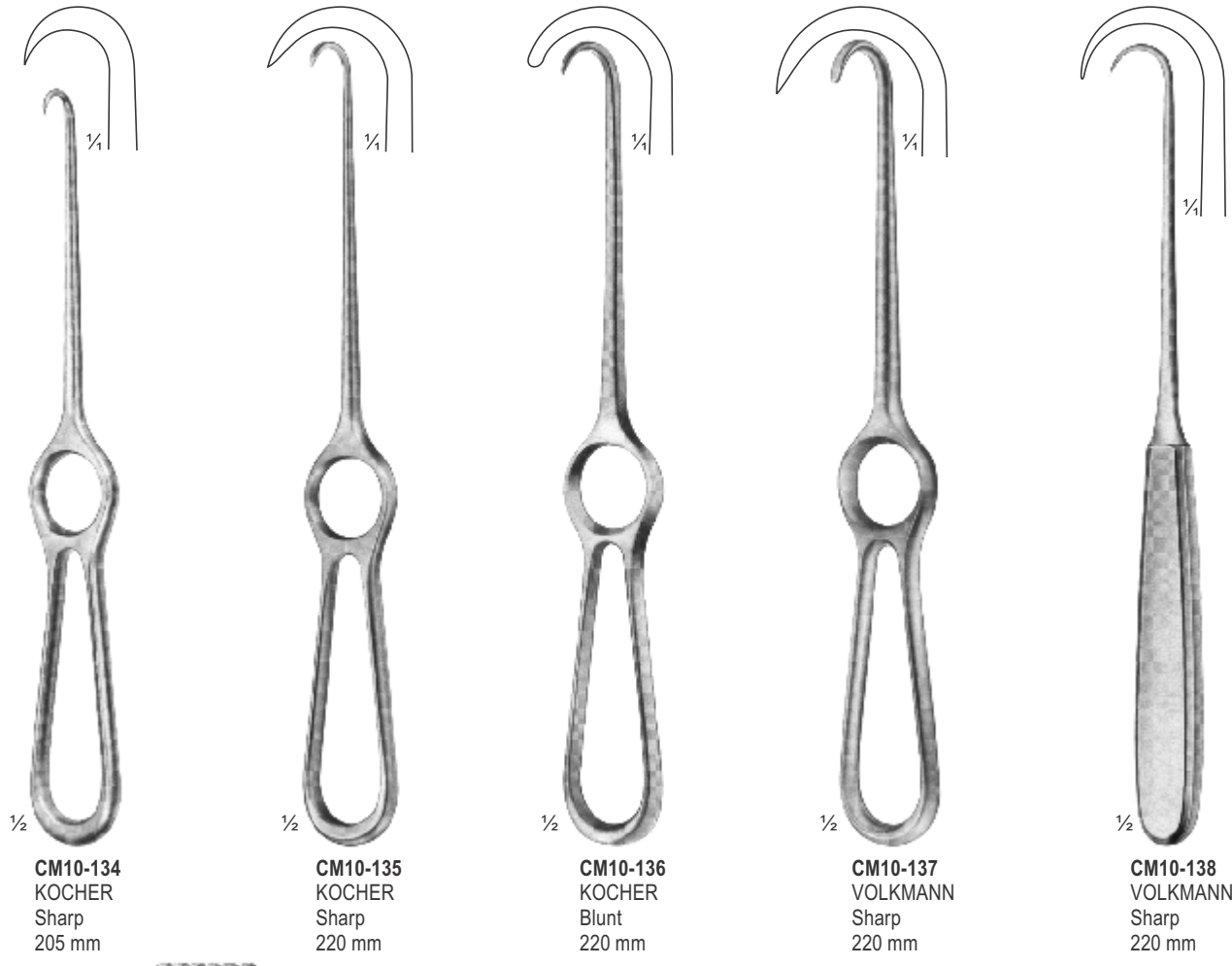

CM10-134
KOCHER
Sharp
205 mm

CM10-135
KOCHER
Sharp
220 mm

CM10-136
KOCHER
Blunt
220 mm

CM10-137
VOLKMANN
Sharp
220 mm

CM10-138
VOLKMANN
Sharp
220 mm



CM10-139 - 146
VOLKMANN
225 mm

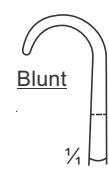
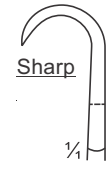

CM10-139
9 x 8 mm



CM10-140
9 x 13 mm



CM10-141
9 x 19 mm



CM10-142
9 x 29 mm



CM10-143
8,5 x 8 mm



CM10-144
8,5 x 13 mm



CM10-145
8,5 x 19 mm



CM10-146
8,5 x 29 mm

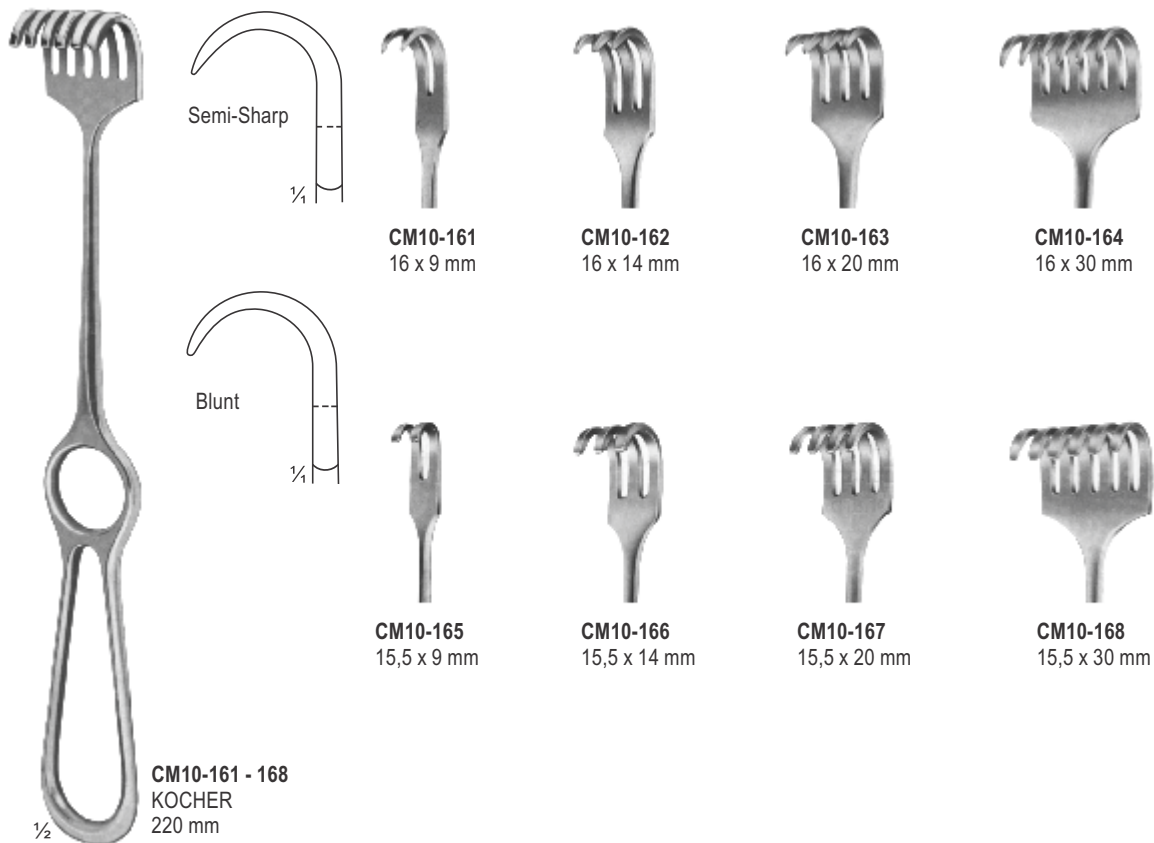
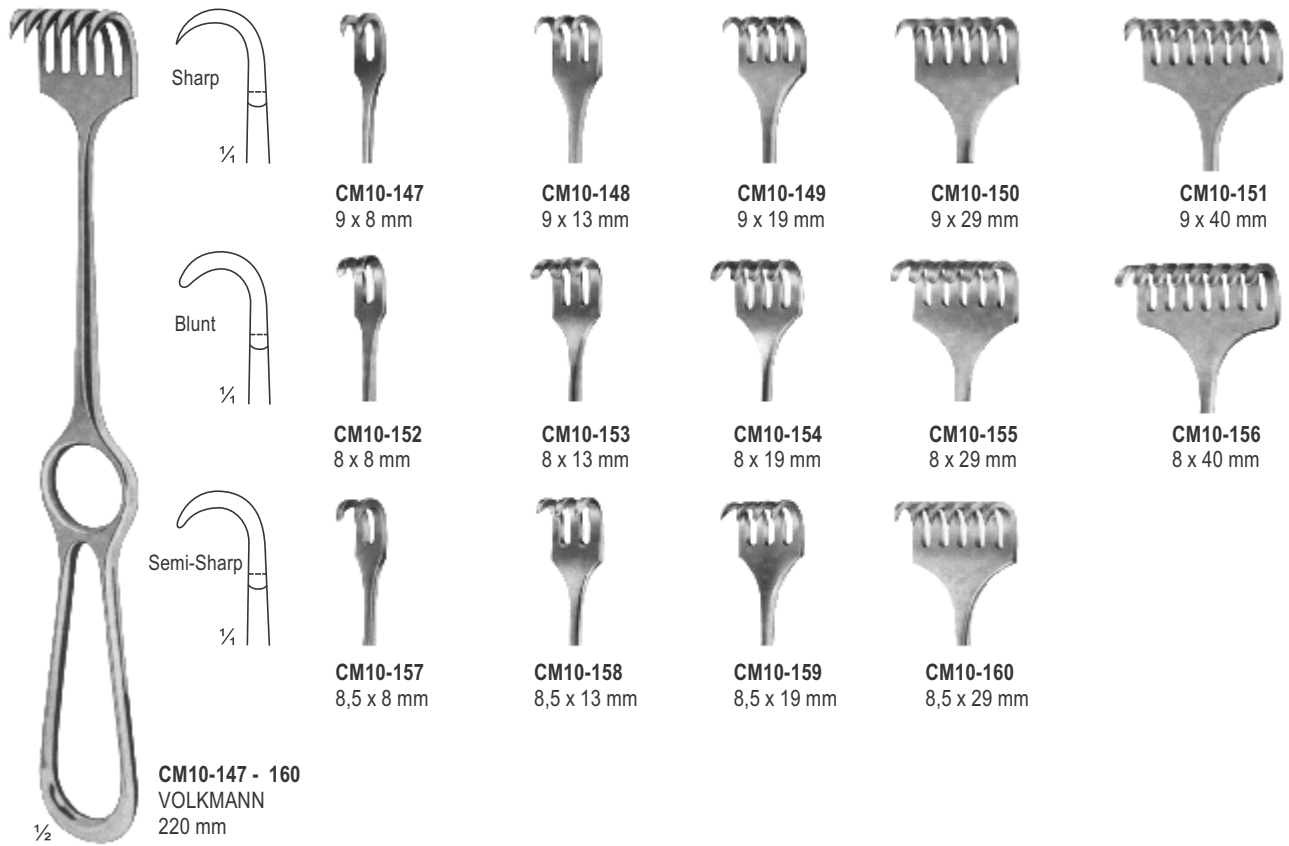



CM10-168 - 170
KORTE
240 mm



CM10-169
8 Prongs, blunt



CM10-170
8 Prongs, sharp



CM10-171 - 174
ISRAEL
255 mm

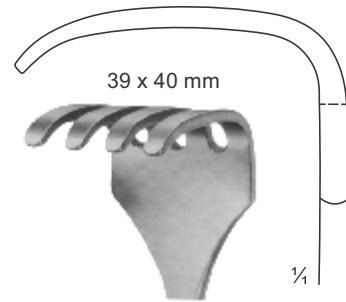

CM10-171
4 Prongs, blunt

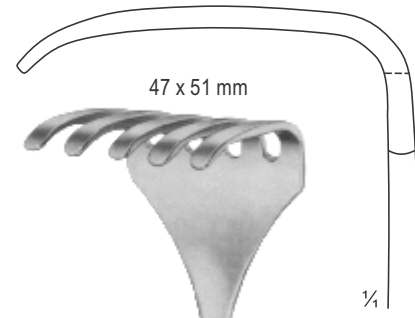

CM10-172
5 Prongs, blunt

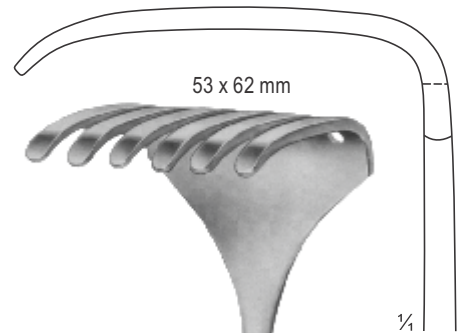

CM10-173
6 Prongs, blunt

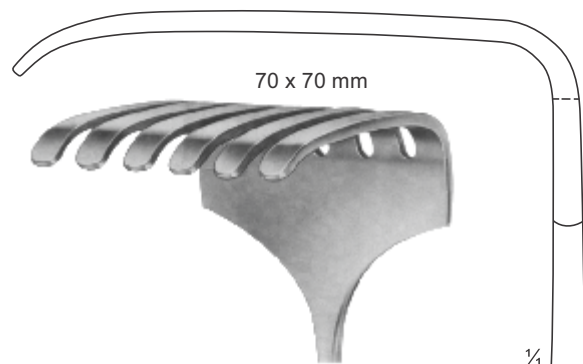

CM10-174
6 Prongs, blunt

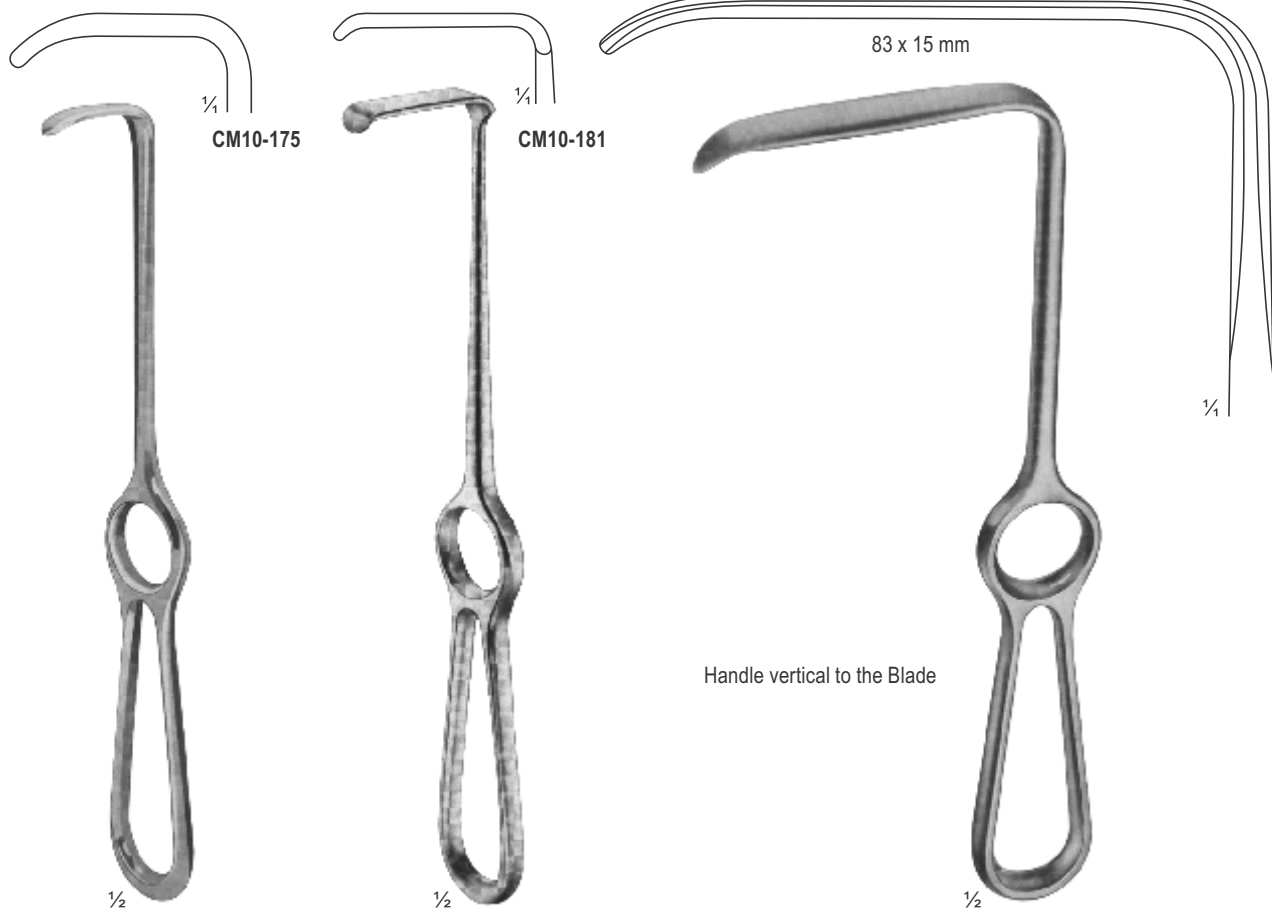

CM10-175 - 180
LANGENBECK
210 mm

- CM10-175** 28 x 10 mm
- CM10-176** 28 x 14 mm
- CM10-177** 33 x 14 mm
- CM10-178** 28 x 16 mm
- CM10-179** 40 x 10 mm
- CM10-180** 40 x 13 mm

CM10-181 - 187
KOCHER-LANGENBECK
215 mm

- CM10-181** 25 x 6 mm
- CM10-182** 35 x 8 mm
- CM10-183** 35 x 11 mm
- CM10-184** 35 x 15 mm
- CM10-185** 41 x 11 mm
- CM10-186** 55 x 11 mm
- CM10-187** 70 x 14 mm

CM10-188
LANGENBECK
215 mm

Handle vertical to the Blade



CM10-189 - 193
KOCHER
230 mm



CM10-194 - 196
SAUERBRUCH
225 mm

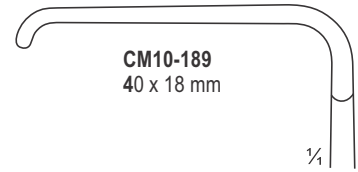

CM10-189
40 x 18 mm

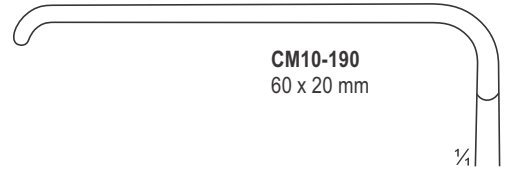

CM10-190
60 x 20 mm

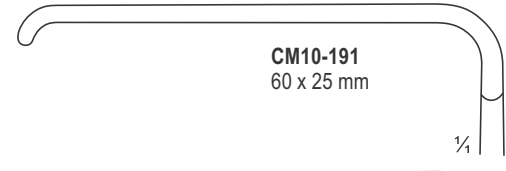

CM10-191
60 x 25 mm

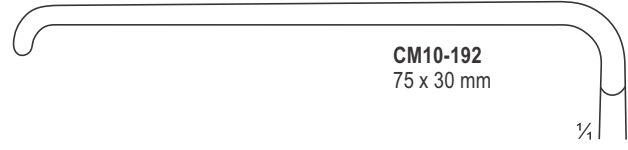

CM10-192
75 x 30 mm

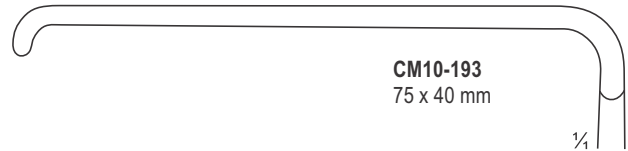

CM10-193
75 x 40 mm

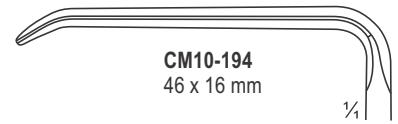

CM10-194
46 x 16 mm

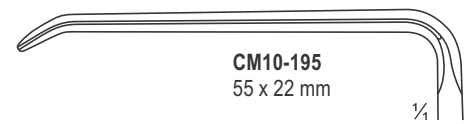

CM10-195
55 x 22 mm



CM10-196
72 x 19 mm



1/2
CM10-197
15 x 15 mm
220 mm



1/2
CM10-198
20 x 22 mm
215 mm



1/2
CM10-197 -199
MIDDELDORPF

1/2
CM10-199
28 x 28 mm
235 mm

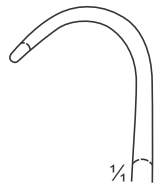

1/4

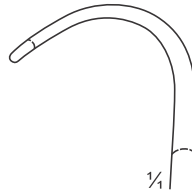

1/4

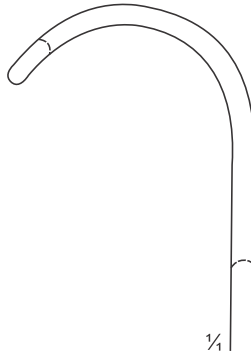

1/4

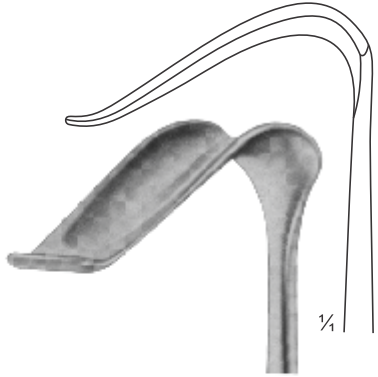

38 x 18 mm

1/2
CM10-200
BUCHS
205 mm



67 x 17 mm

1/4

1/2
CM10-201
CASPAR
210 mm

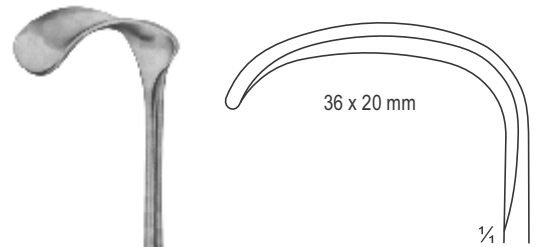

36 x 20 mm

1/4

1/2
CM10-202
KOCHER
230 mm



1/2

CM10-203 - CM10-208
HOSEL
250 mm

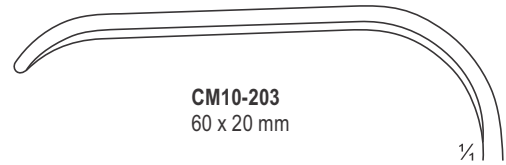

CM10-203
60 x 20 mm

1/4



CM10-204
80 x 30 mm

1/4

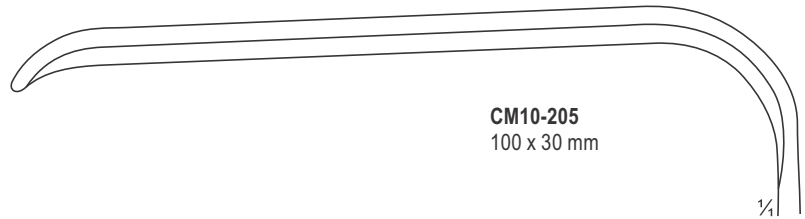

CM10-205
100 x 30 mm

1/4

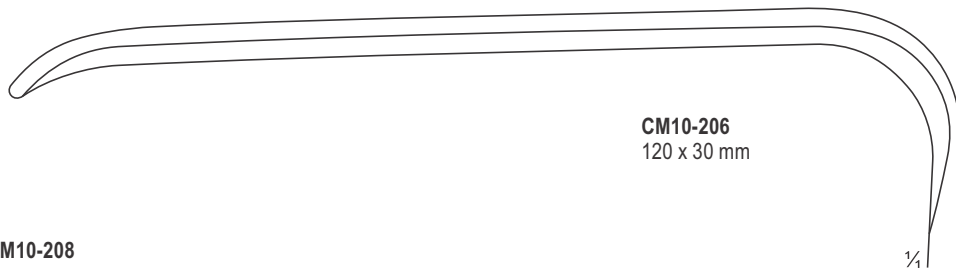

CM10-206
120 x 30 mm

1/4

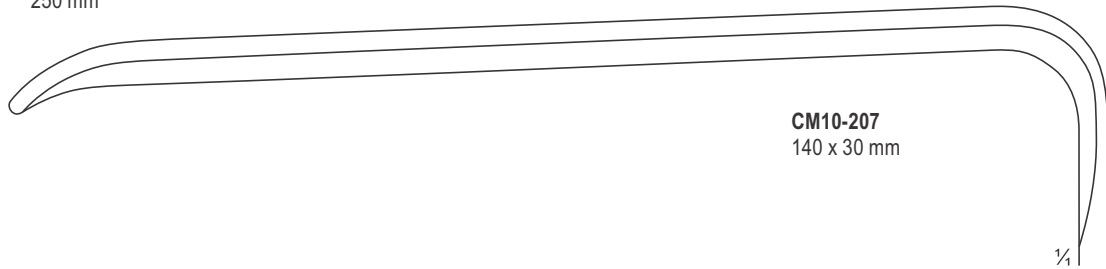

CM10-207
140 x 30 mm

1/4

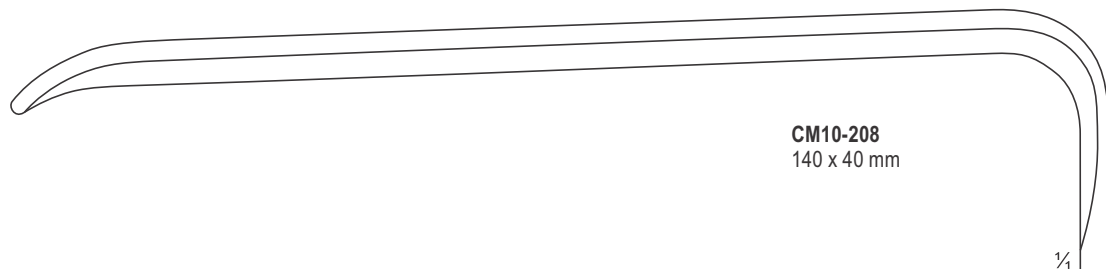

CM10-208
140 x 40 mm

1/4

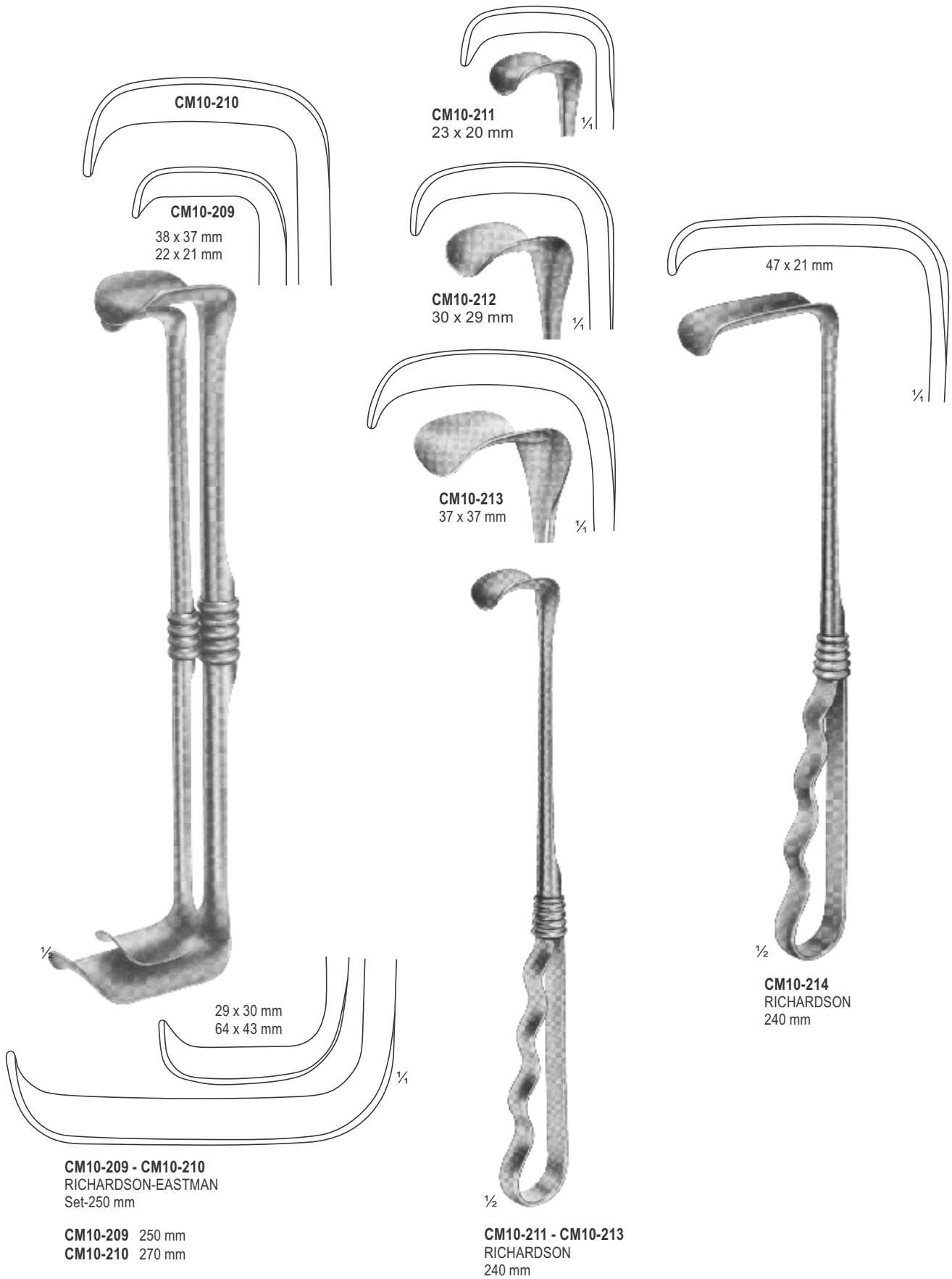

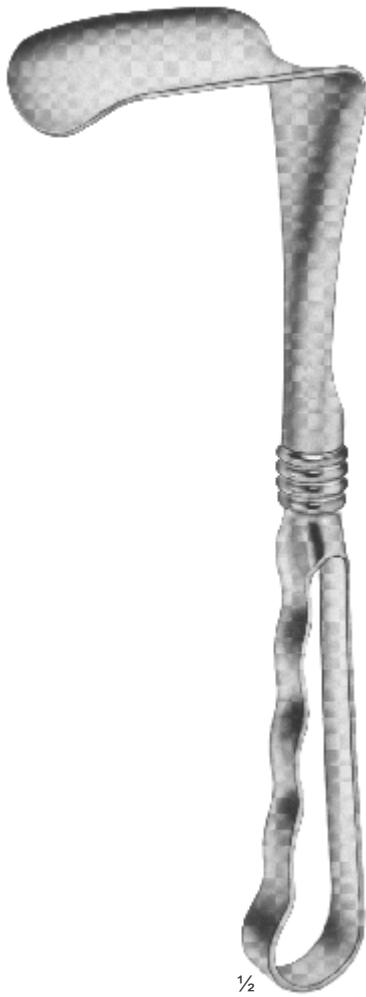
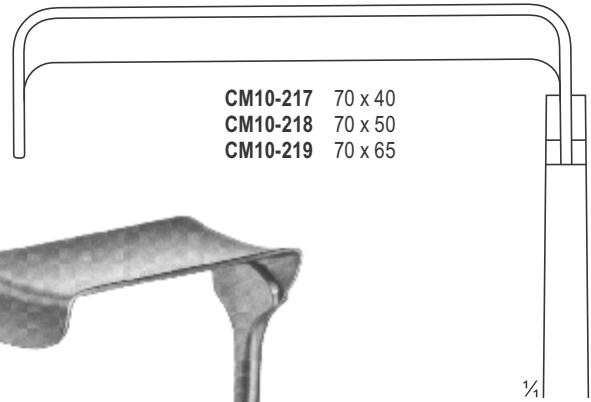
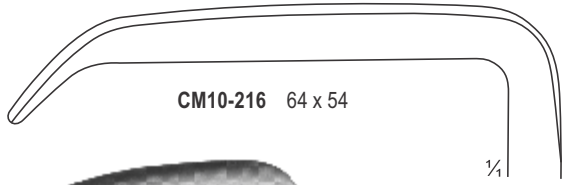
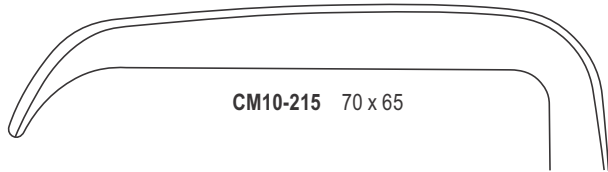

CM10-215 - CM10-216
KELLY
260 mm



CM10-217 - CM10-219
MORRIS
245 mm

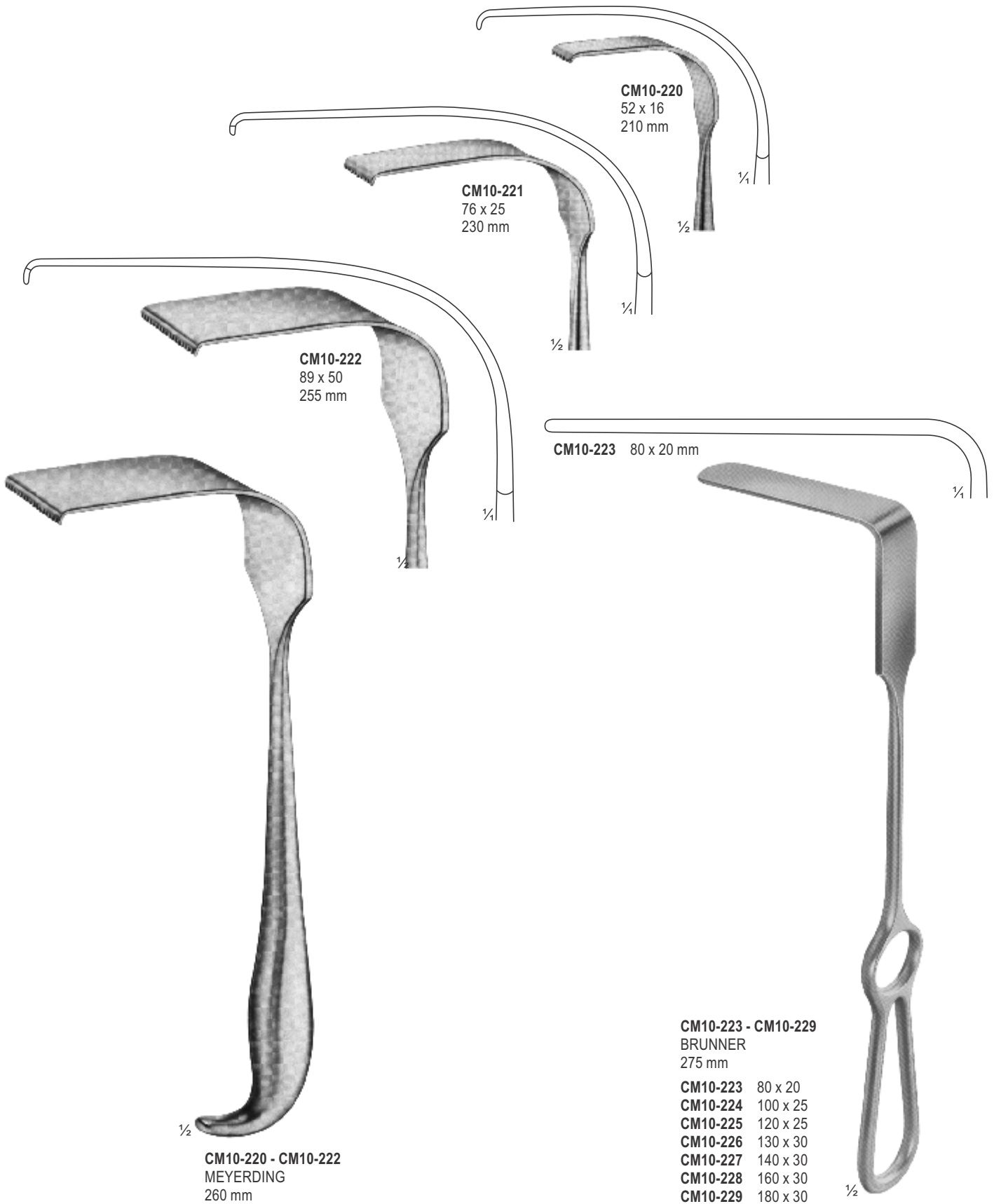



1/2

ZENKER
CM10-230 - CM10-235

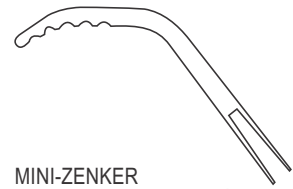

MINI-ZENKER
CM10-230
180 mm
10 X 3 mm

1/4

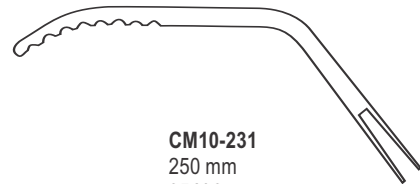

CM10-231
250 mm
35 X 8 mm

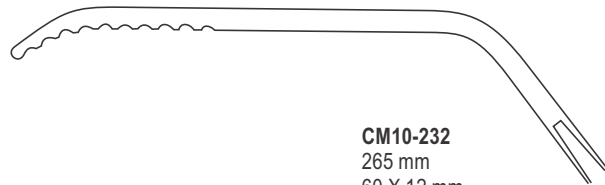

CM10-232
265 mm
60 X 12 mm

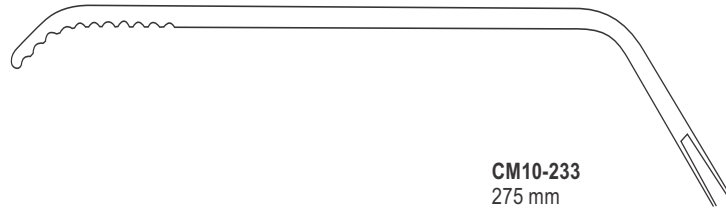

CM10-233
275 mm
75 X 12 mm

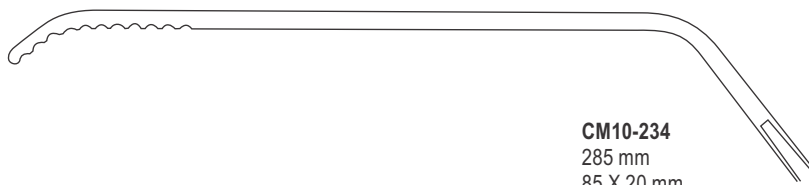

CM10-234
285 mm
85 X 20 mm

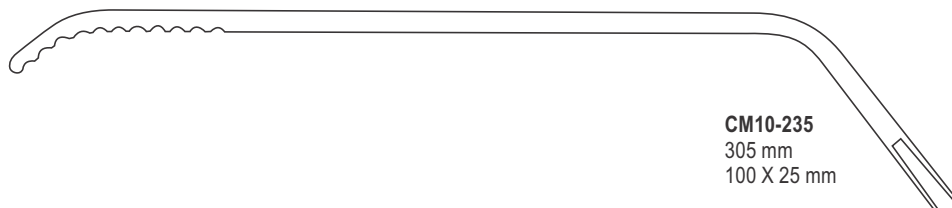

CM10-235
305 mm
100 X 25 mm



HOSEL
CM10-236 - CM10-241
250 mm

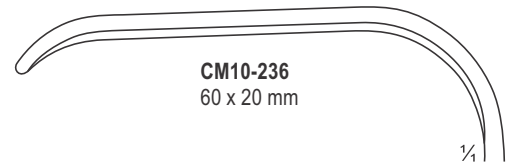

CM10-236
60 x 20 mm

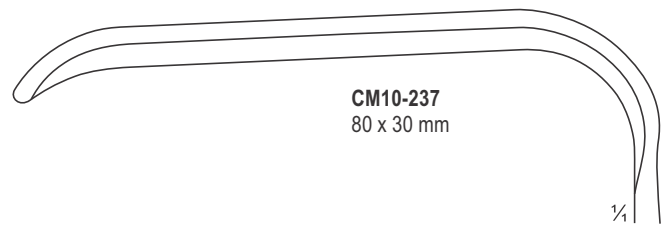

CM10-237
80 x 30 mm

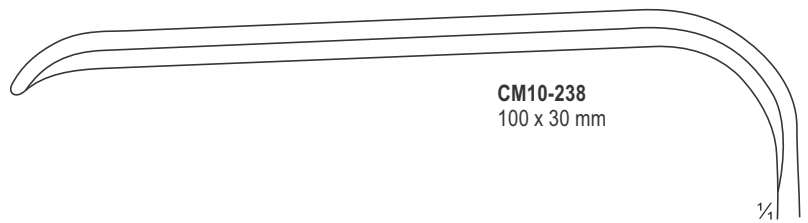

CM10-238
100 x 30 mm

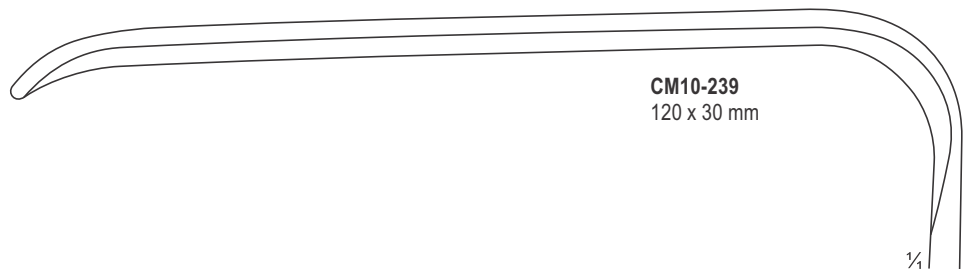

CM10-239
120 x 30 mm

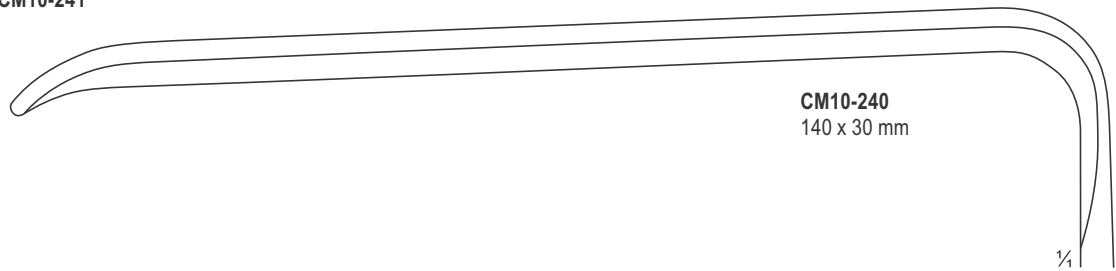

CM10-240
140 x 30 mm

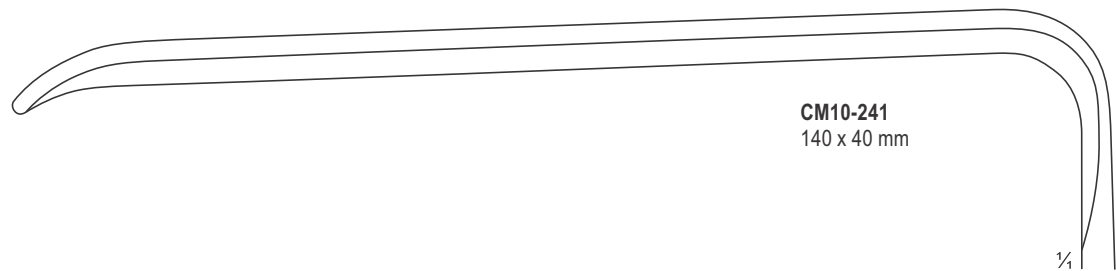

CM10-241
140 x 40 mm



HÖSEL
CM10-242 - CM10-247
260 mm

1/2

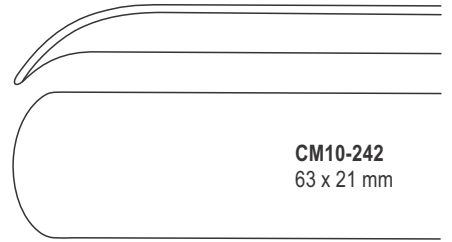

CM10-242
63 x 21 mm

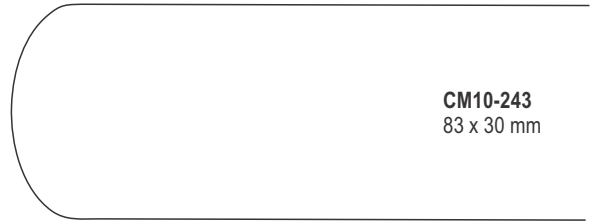

CM10-243
83 x 30 mm

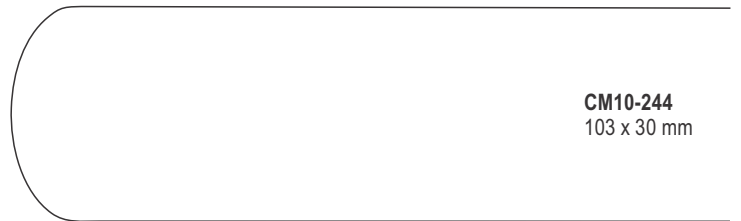

CM10-244
103 x 30 mm

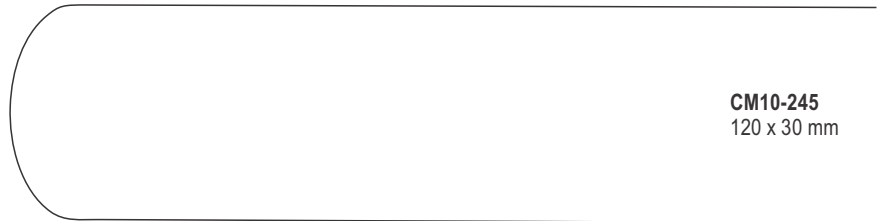

CM10-245
120 x 30 mm

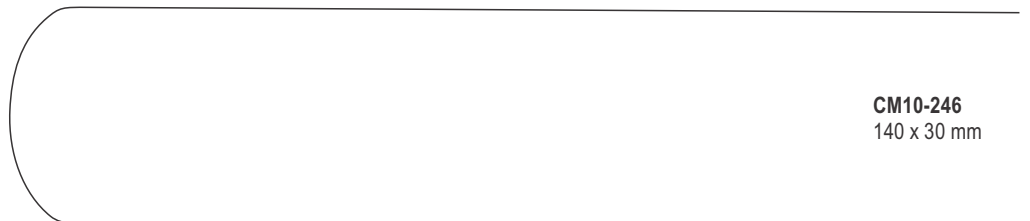

CM10-246
140 x 30 mm

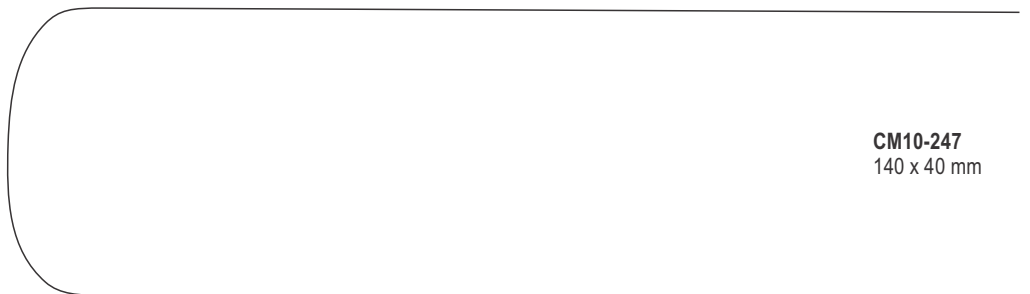

CM10-247
140 x 40 mm

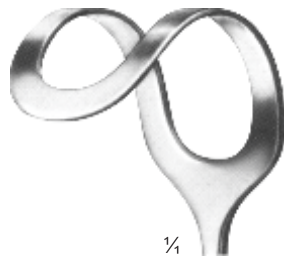

1/4

CM10-248
270 mm
43 X 45 mm

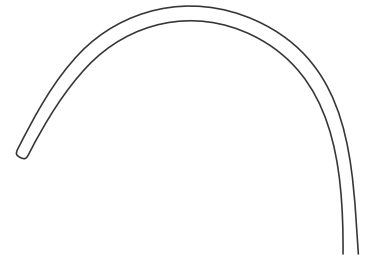

CM10-249
270 mm
52 X 50 mm

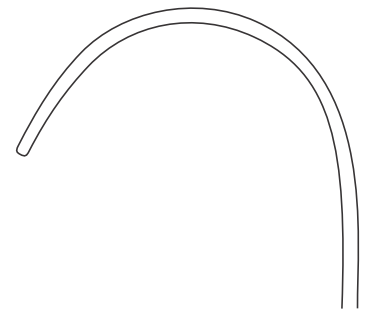

1/2

MIDDENDORPF
CM10-248 - CM10-250



CM10-250
280 mm
52 X 70 mm

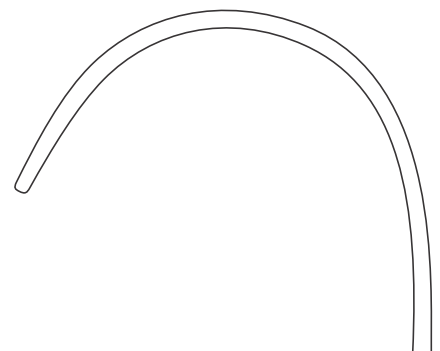

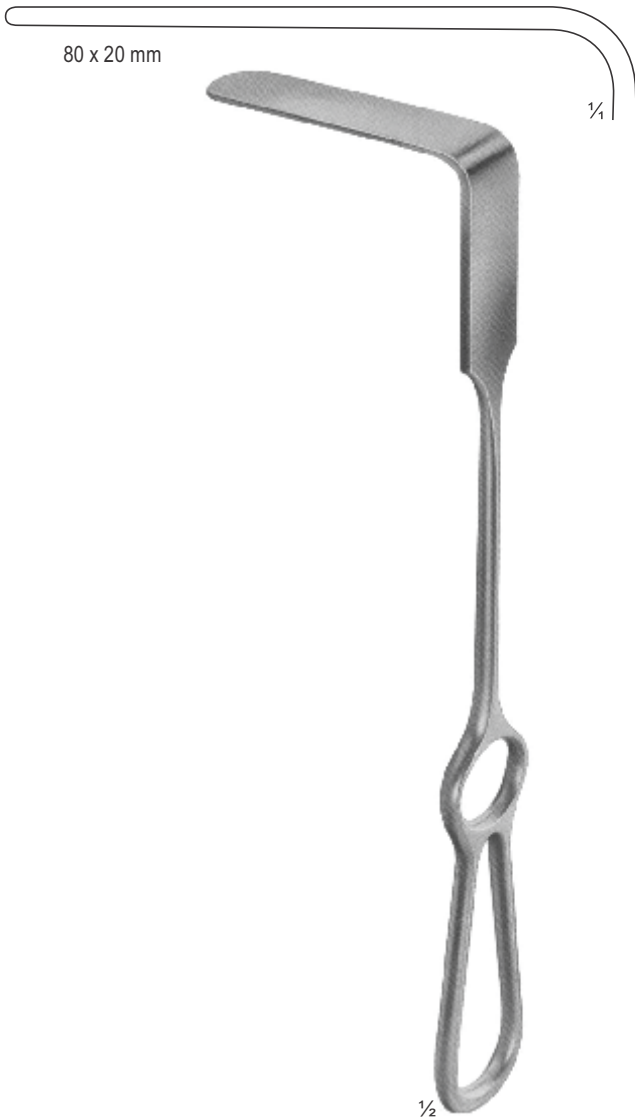

BRUNNER
CM10-251 - CM10-257
275 mm

CM10-251	80 x 20
CM10-252	100 x 25
CM10-253	120 x 25
CM10-254	130 x 30
CM10-255	140 x 30
CM10-256	160 x 30
CM10-257	180 x 30

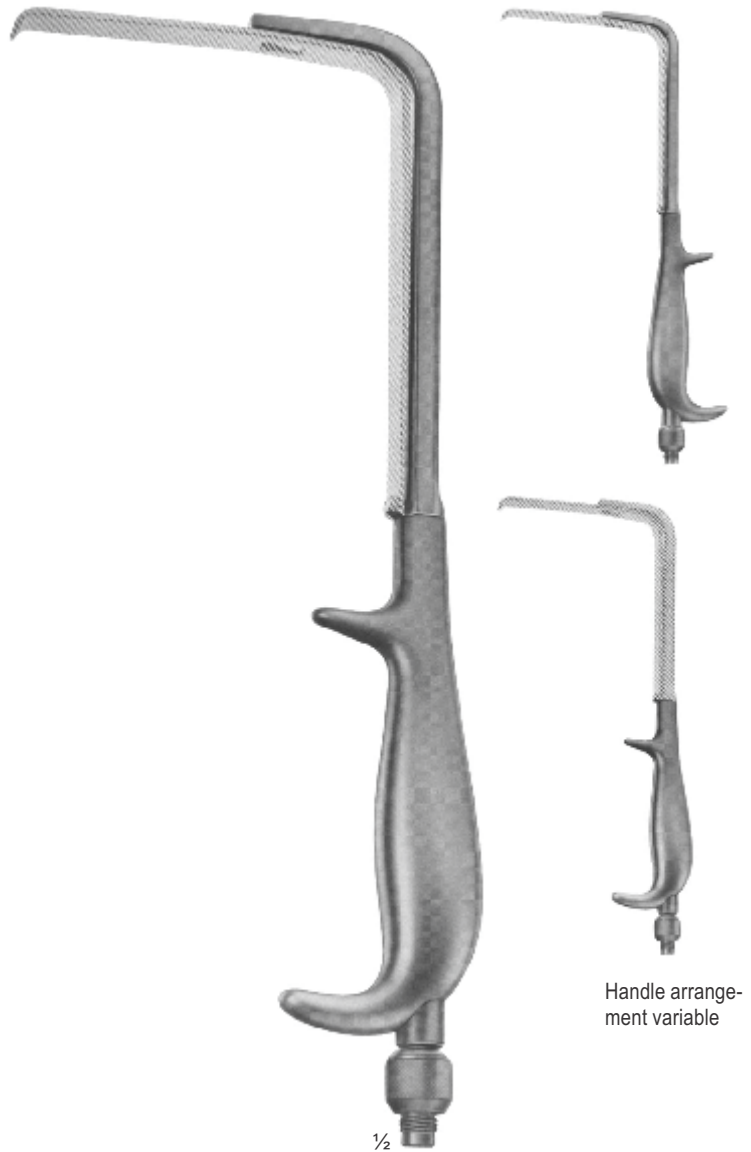

CM10-258
Handle with cold light carrier for retractor blades. 280 mm

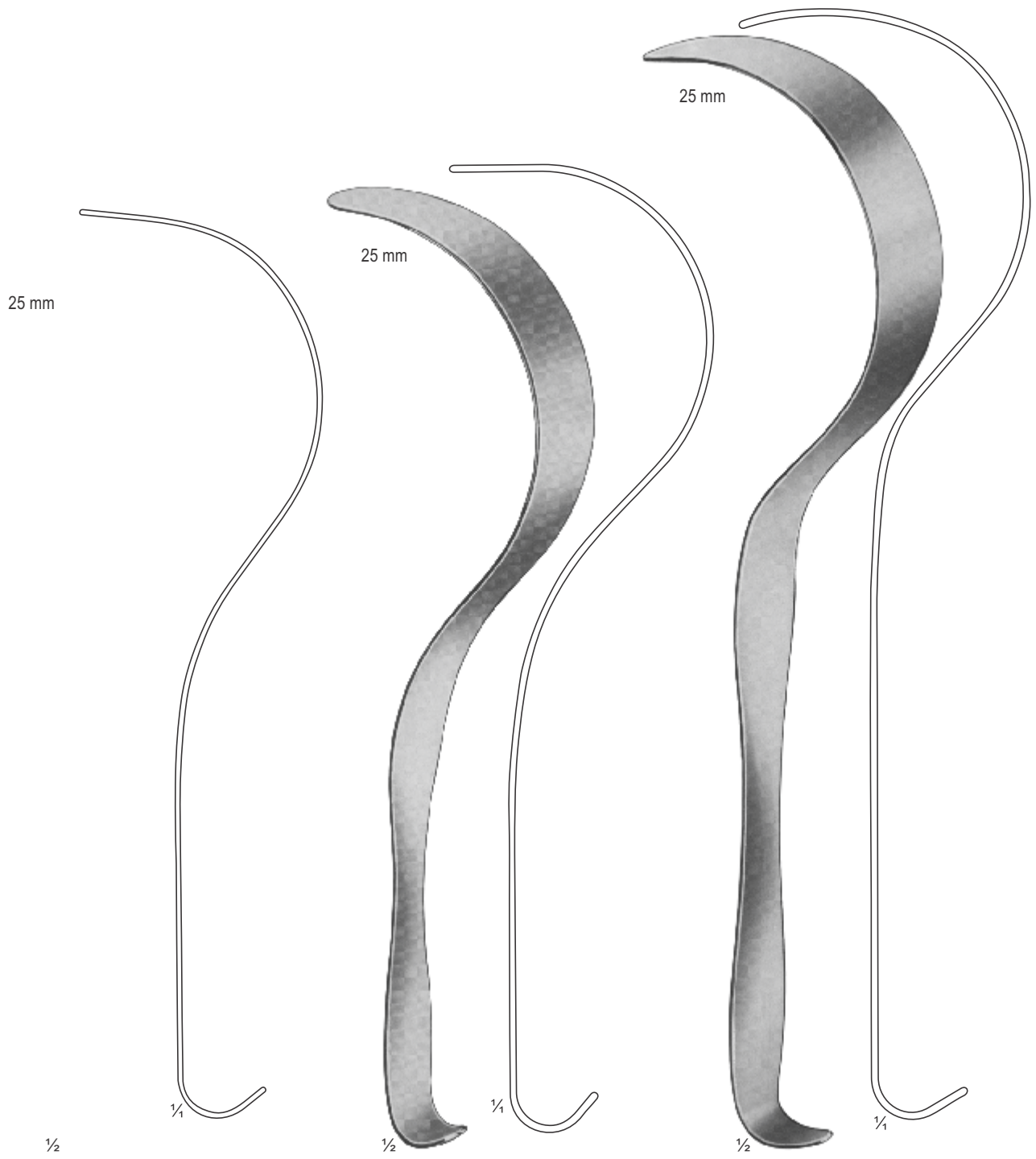

CM10-259
DEAVER
300 mm
Fig. 1

CM10-260
DEAVER
315 mm
Fig. 2

CM10-261
DEAVER
365 mm
Fig. 2



Fig. 3
DEAVER
CM10-262
300 mm

Fig. 4
DEAVER
CM10-263
310 mm

Fig. 5
DEAVER
CM10-264
320 mm

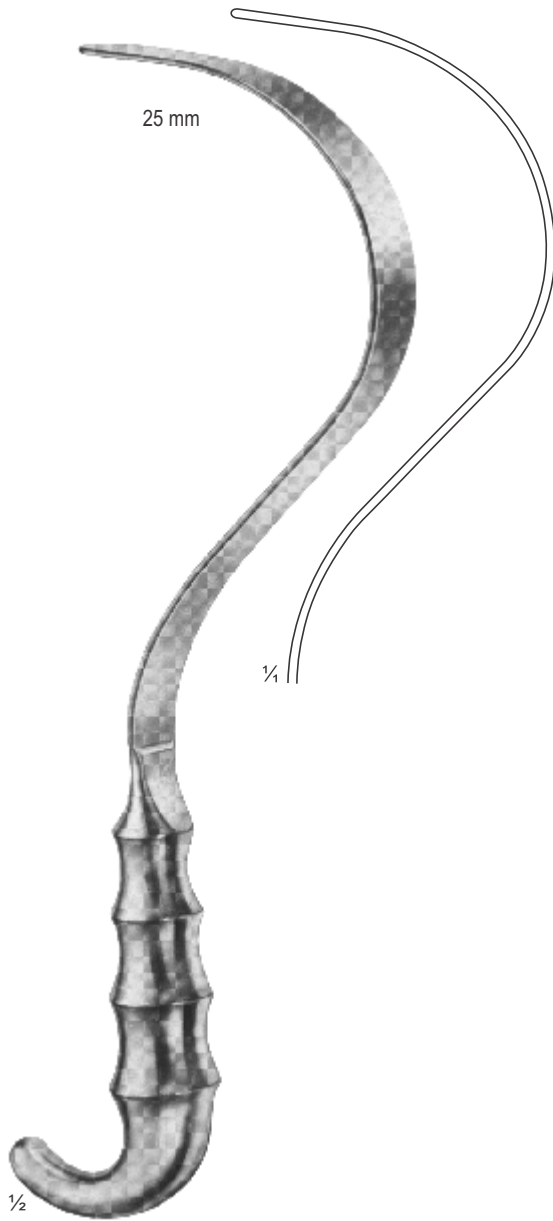

CM10-265
DEAVER
310 mm
Fig. 1

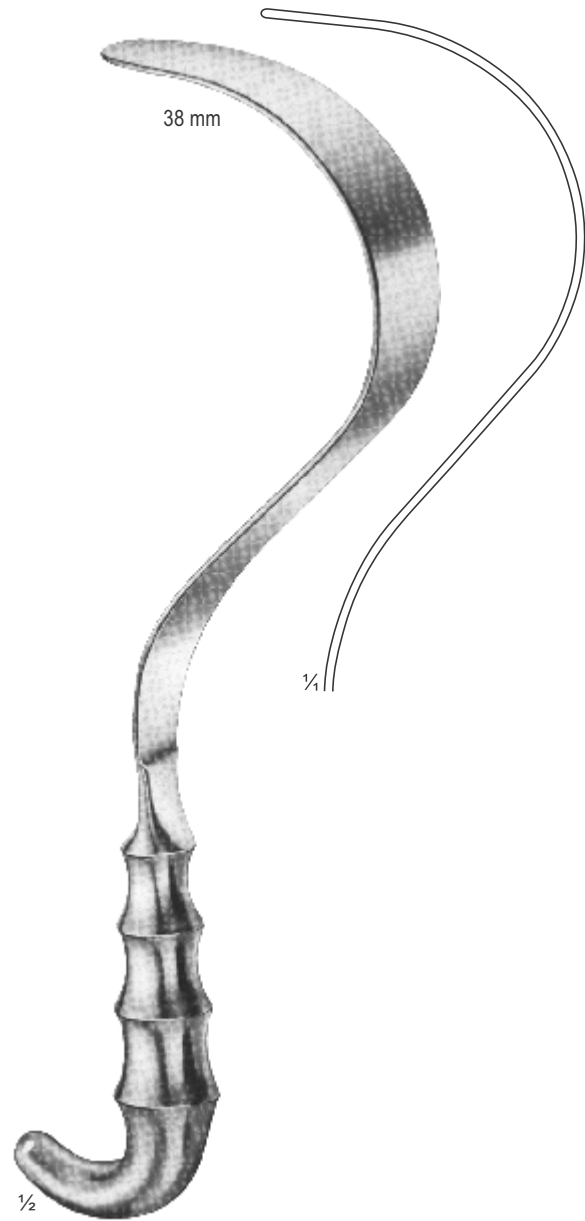

CM10-266
DEAVER
310 mm
Fig. 3



COOLEY
CM10-267
250 mm
Right
48 X 48 mm



COOLEY
CM10-268
250 mm
Right, Serrated
48 X 48 mm



COOLEY
CM10-269
275 mm
Left
30 X 48 mm



ROCHARD
CM10-270 - CM10-274
 310 mm
CM10-270 48 x 90 mm
CM10-271 48 x 105 mm
CM10-272 48 x 120 mm
CM10-273 48 x 135 mm
CM10-274 48 x 155 mm



CM10-275



DOYEN
CM10-276 - CM10-279
 280 mm
CM10-276 48 x 90 mm
CM10-277 48 x 105 mm
CM10-278 48 x 120 mm
CM10-279 48 x 135 mm



DOYEN-CHILD
CM10-280
 Fixation device
 220 mm



CM10-281
 Chain with weight (747 / 645g)
 790 mm



SENN-GREEN
CM10-282 - CM10-283
160 mm



Fig. 1
CM10-282
20 X 6 mm



Fig. 2
CM10-283
10 X 6 mm



RAGNELL-DAVIS
CM10-284
150 mm



$\frac{1}{4}$
8 X 4.5 mm

15 X 5.5 mm



CUSHING
CM10-285
205 mm

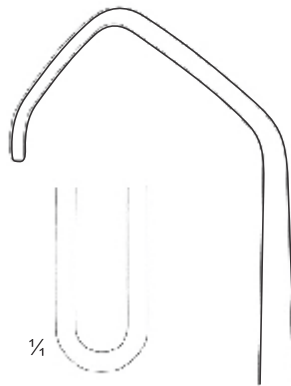

$\frac{1}{4}$



19 x 15 mm
19 x 15 mm

PARKER
CM10-286
140 mm

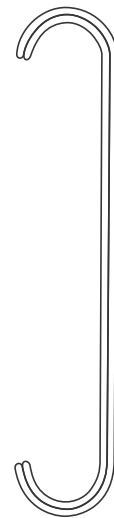

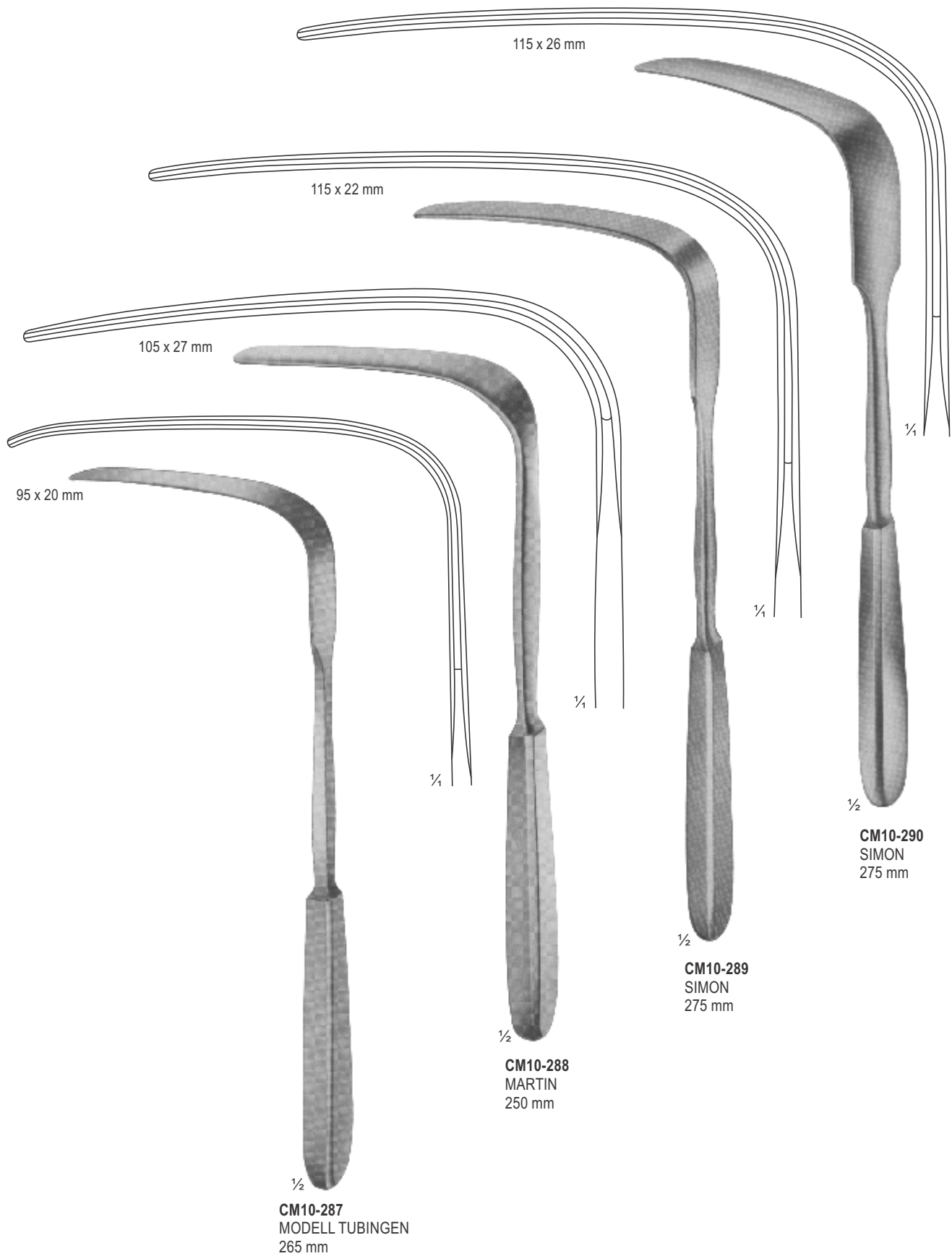

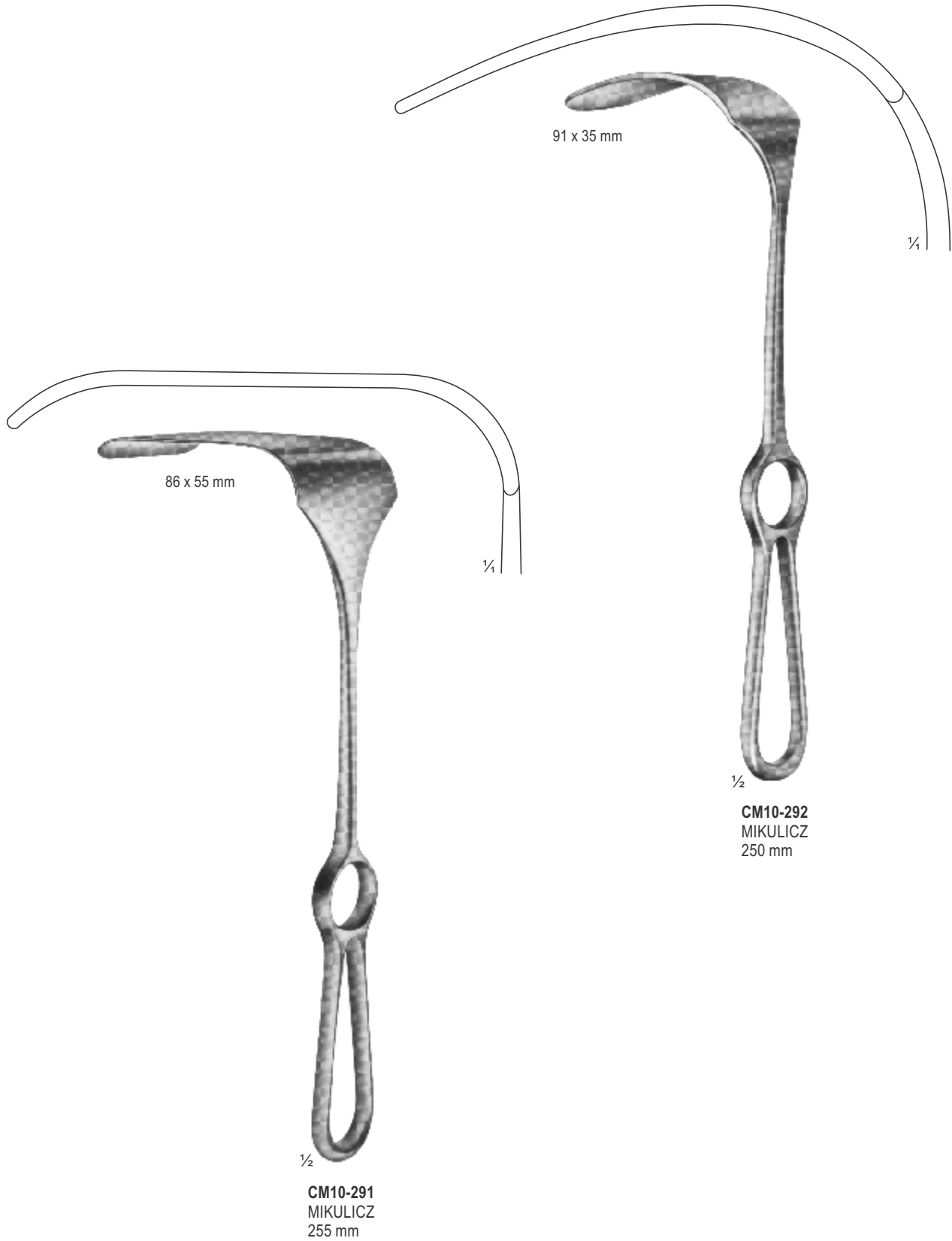

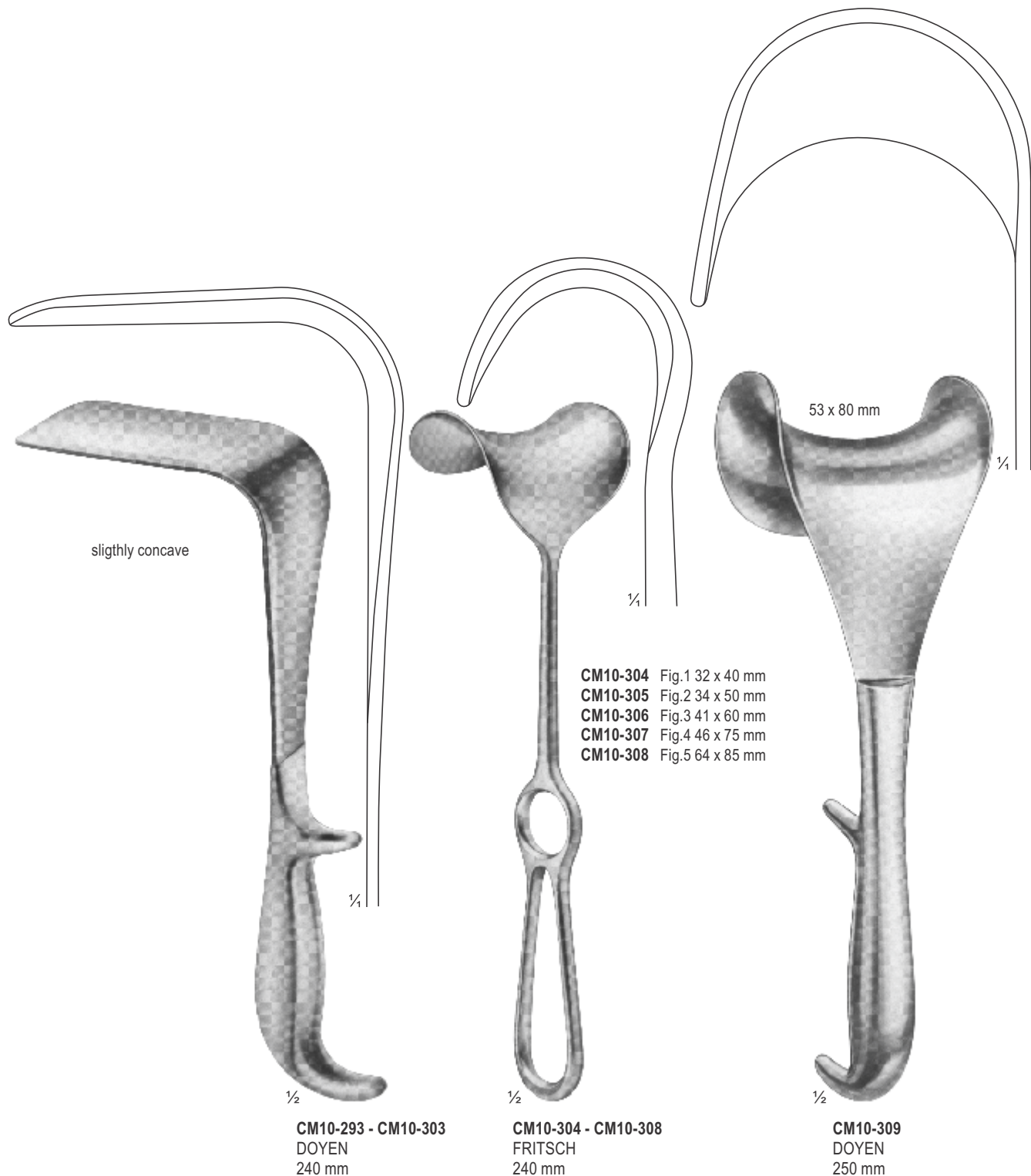

- CM10-304 Fig.1 32 x 40 mm
- CM10-305 Fig.2 34 x 50 mm
- CM10-306 Fig.3 41 x 60 mm
- CM10-307 Fig.4 46 x 75 mm
- CM10-308 Fig.5 64 x 85 mm

CM10-293 - CM10-303
DOYEN
240 mm

CM10-304 - CM10-308
FRITSCH
240 mm

CM10-309
DOYEN
250 mm

Width of Blades
35 mm, 45 mm, 60 mm

Length of Blades
62 mm
92 mm
122 mm
160 mm

CM10-293 , CM10-297 , CM10-301
CM10-294 , CM10-298 , CM10-302
CM10-295 , CM10-299 , CM10-303
CM10-296 , CM10-300

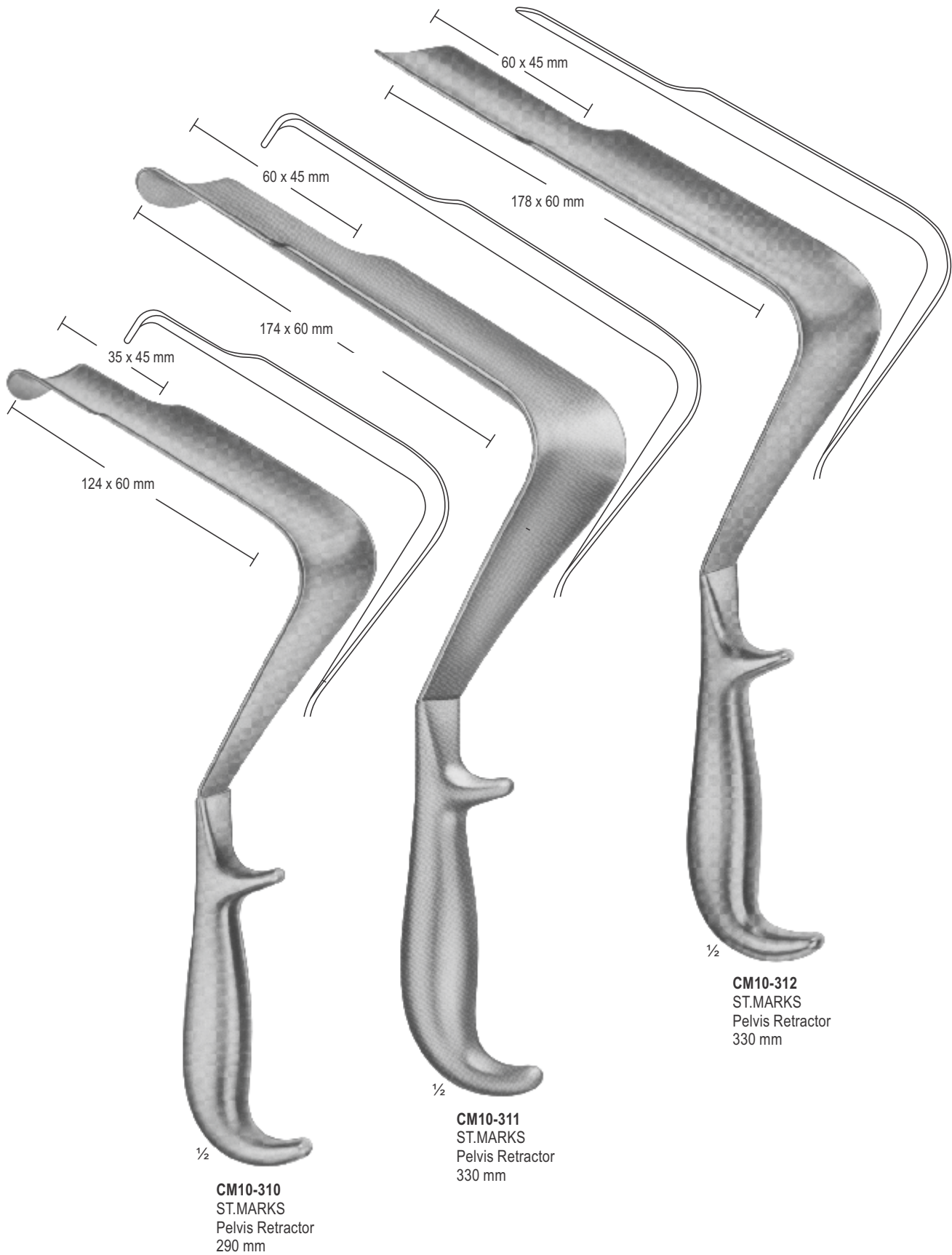



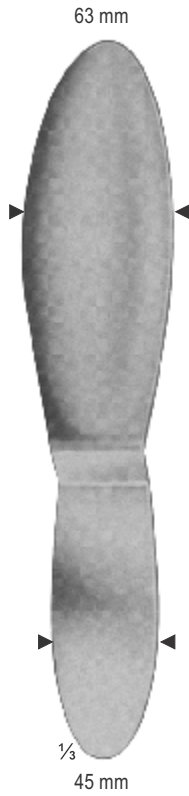

CM10-318
REVERDIN
285 mm



CM10-319
HABERER
Malleable
305 mm



CM10-320 - 322
CM10-320 30 mm
CM10-321 40 mm
CM10-322 50 mm
Malleable
330 mm



CM10-323
TUFFIER
Melleable
200 mm



CARE MEDICAL[®]
SUPPLIES

Your health _ Our Priority

Section

11

Page 188-212

Lamina Spreaders
Self-retaining Retractors
Wound Spreaders, Self-retaining
Special Retractors
Retractors For CerCM11-cal Spine
Retractors For CerCM11-cal Vertebral Column
Abdominal Retractors



1/4



1/2

CM11-001
WEITLANER
Sharp
110 mm



1/4



1/2

CM11-002
WEITLANER
Semi-Sharp
110 mm



1/4



1/2

CM11-003
WEITLANER
Blunt
110 mm



1/4



1/2

CM11-004
WEITLANER
Sharp
130 mm



1/4



1/2

CM11-005
WEITLANER
Semi-Sharp
130 mm



1/4



1/2

CM11-006
WEITLANER
Blunt
130 mm

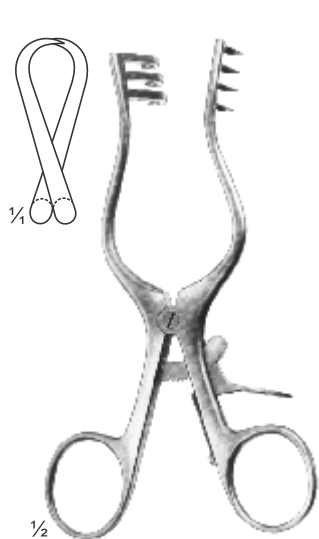

CM11-007
WEITLANER
Sharp
130 mm

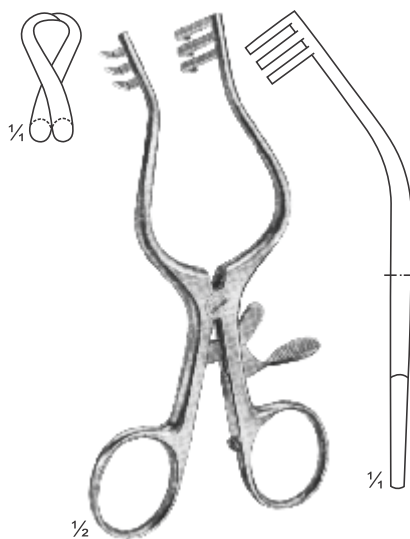

CM11-008
WULLSTEIN
Sharp
130 mm

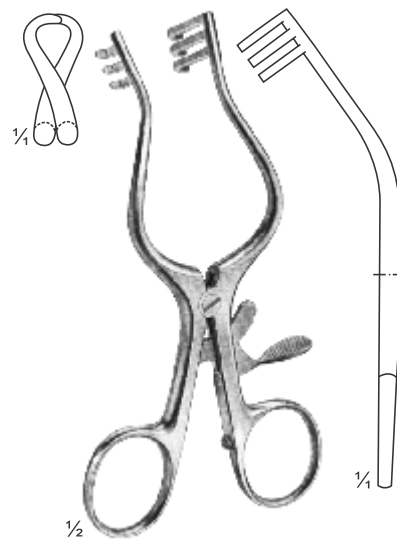

CM11-009
WULLSTEIN
Blunt
130 mm

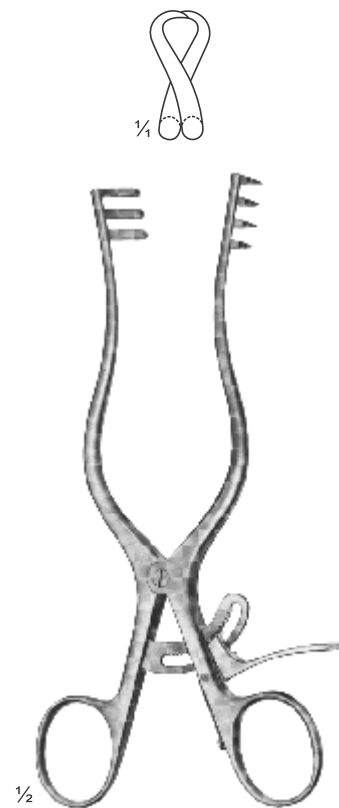

CM11-010
WEITLANER
Sharp
165 mm



CM11-011
PLESTER
Blunt
110 mm

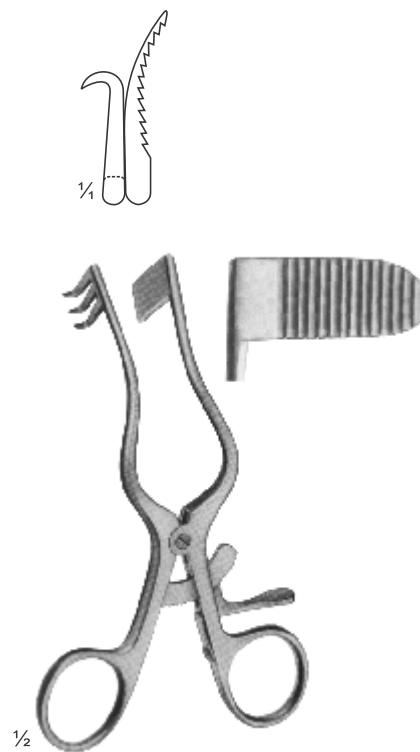

CM11-012
PERKINS
Blunt
130 mm



CM11-013
ADSON-BABY
Blunt
140 mm

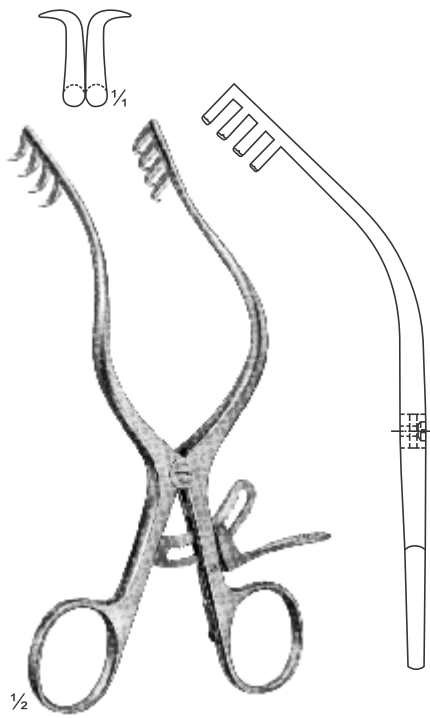

CM11-014
MOLLISON
Sharp
155 mm

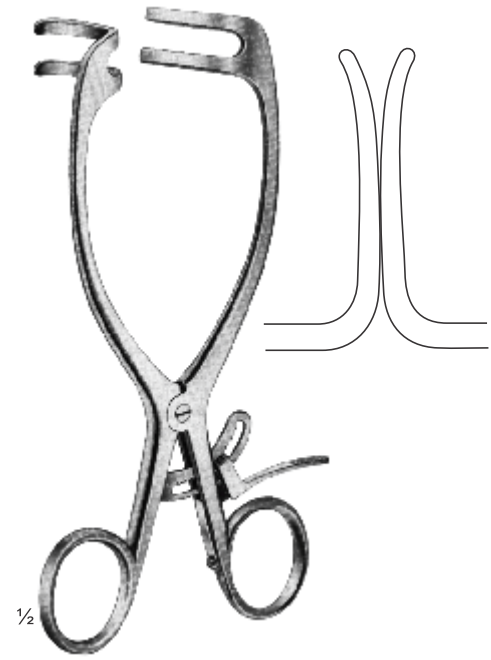

CM11-015
MAYO-ADAMS
165 mm

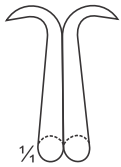

CM11-016
ANDERSON-ADSON
Sharp
190 mm



CM11-017
NORFOLK and
NORWICH
Blunt
220 mm



CM11-018
ADSON
Sharp
265 mm

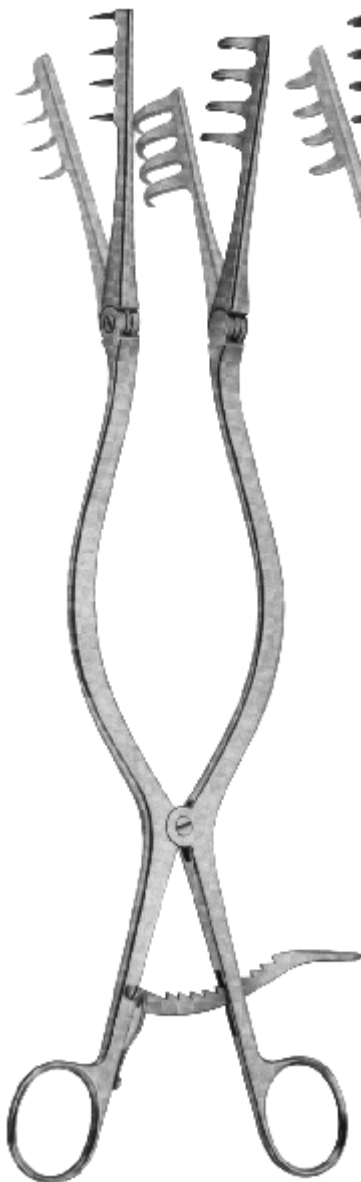
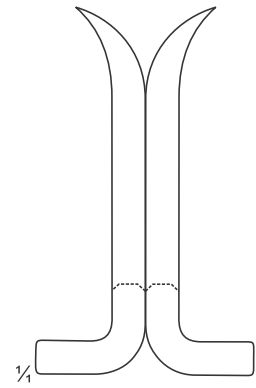
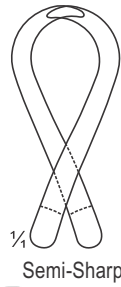
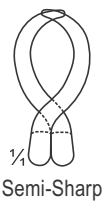
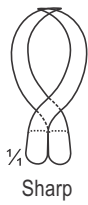

1/2
CM11-019
BECKMANN-ADSON
Sharp
310 mm



CM11-019A
BECKMANN-ADSON
Semi-Sharp
310 mm

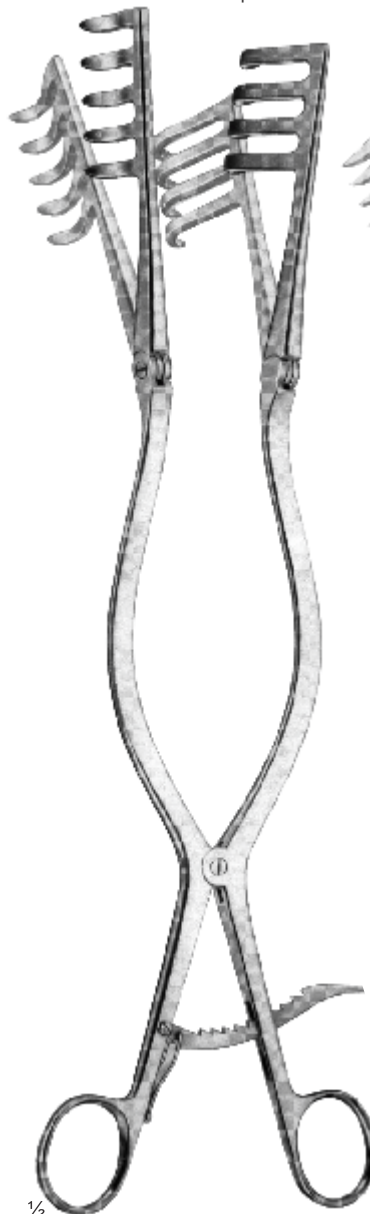

1/2
CM11-020
ADSON
Semi-Sharp
320 mm

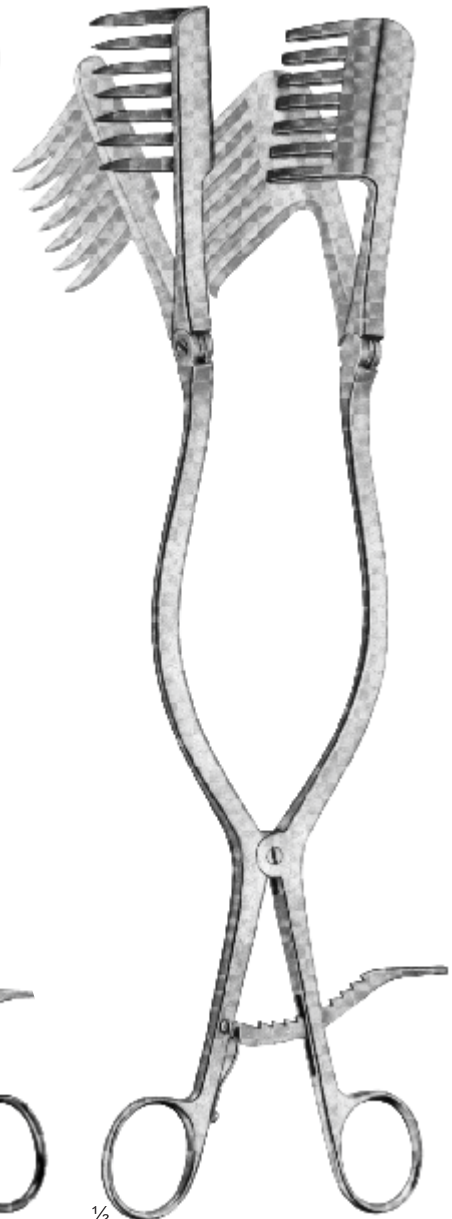

1/2
CM11-021
BECKMANN-EATON
Sharp
320 mm

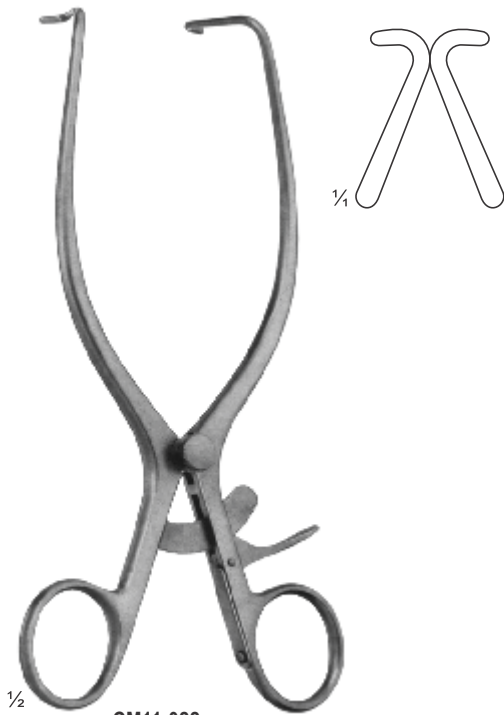

$\frac{1}{2}$
CM11-022
JACKSON BURROWS
Retractor, blunt
185 mm



$\frac{1}{2}$
CM11-023
GELPI
Vaginal Retractor
135 mm



$\frac{1}{2}$
CM11-024
GELPI
Skin- and Vaginal Retractor
175 mm



$\frac{1}{2}$
CM11-025
DE BAKEY
Femur Retractor
145 mm

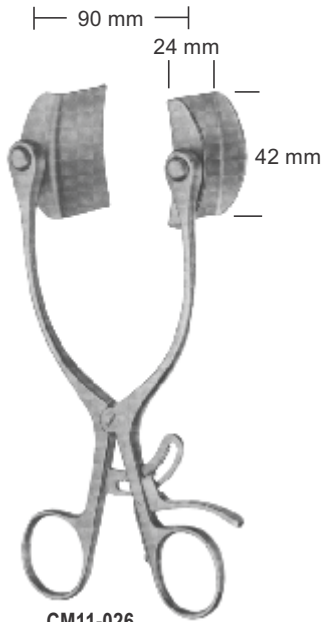

CM11-026
BABY-COLLIN
with 2 pair of blades

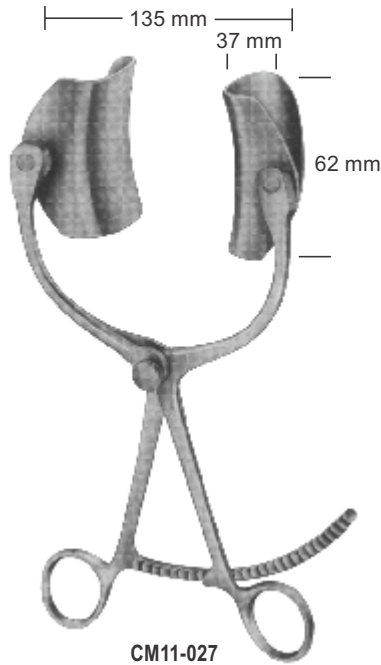

CM11-027
COLLIN
complete

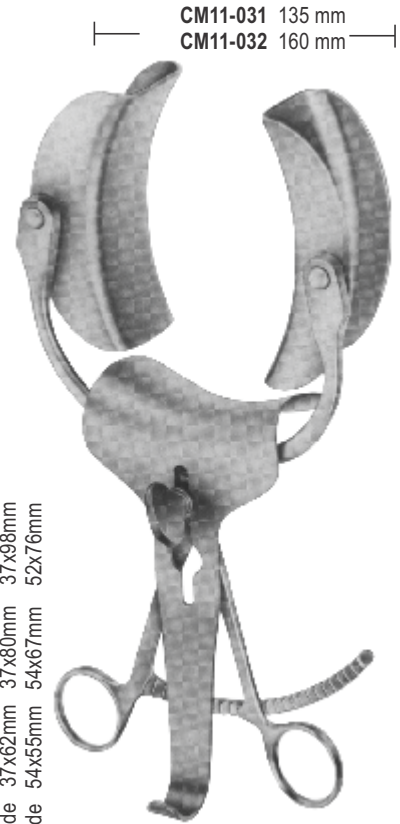

CM11-031 135 mm
CM11-032 160 mm

CM11-028 37x62mm
CM11-029 37x80mm
CM11-030 37x98mm
Spreader only
Lateral blade 54x55mm
Canter blade 52x76mm

CM11-028 - CM11-032
COLLIN
complete



CM11-033 - CM11-034
RICARD
complete

Spreader only **CM11-033** **CM11-034**
Lateral blade 58x80mm 72x84mm
Canter blade 54x70mm 72x90mm



CM11-035 - CM11-037
HOLZBACH
Complete

CM11-035 Spreader only
CM11-036 Lateral blade 59x80mm
CM11-037 Canter blade 74x82mm

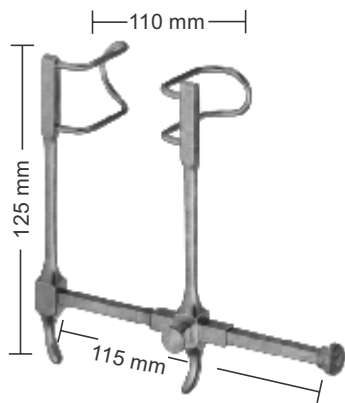

CM11-038
GOSSET
Blades:38 mm deep

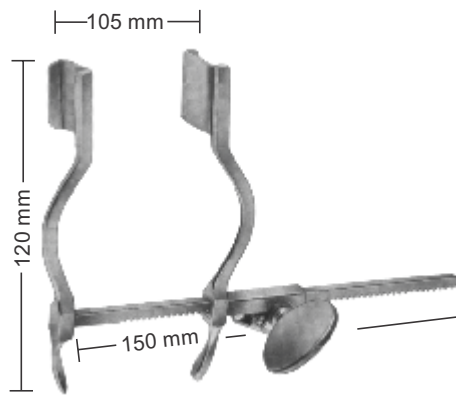

CM11-039
HERTZLER
Blades 20 X 25 mm

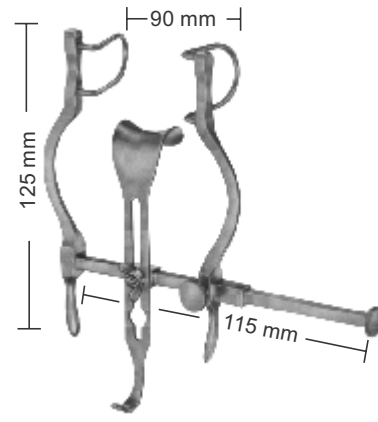

CM11-040
BALFOUR-BABY
Lateral blades 27 mm deep
Center blade 21x24 mm

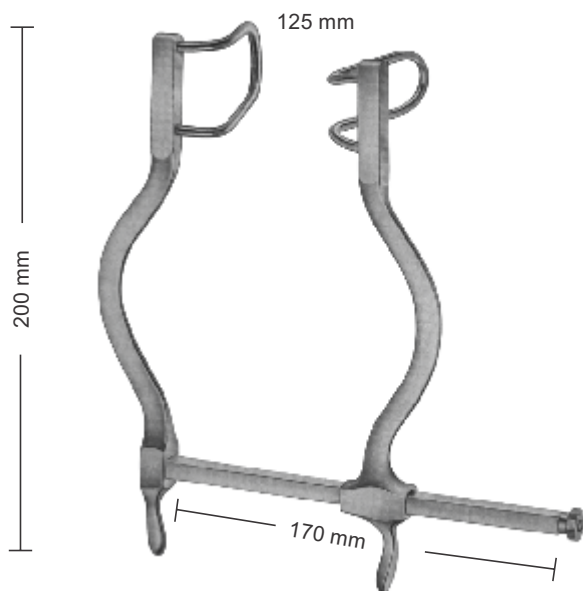

CM11-041
GOSSET
Blades:55mm deep

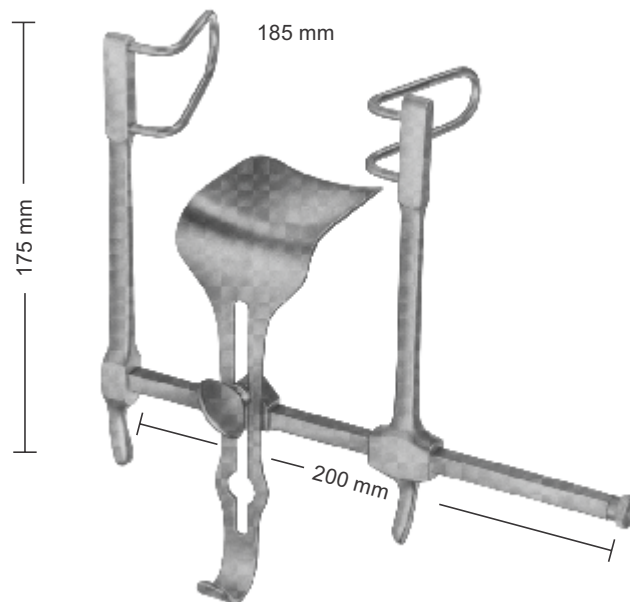

CM11-042
GOSSET
Lateral blades 58 mm deep
Center blade 59 x 57 mm

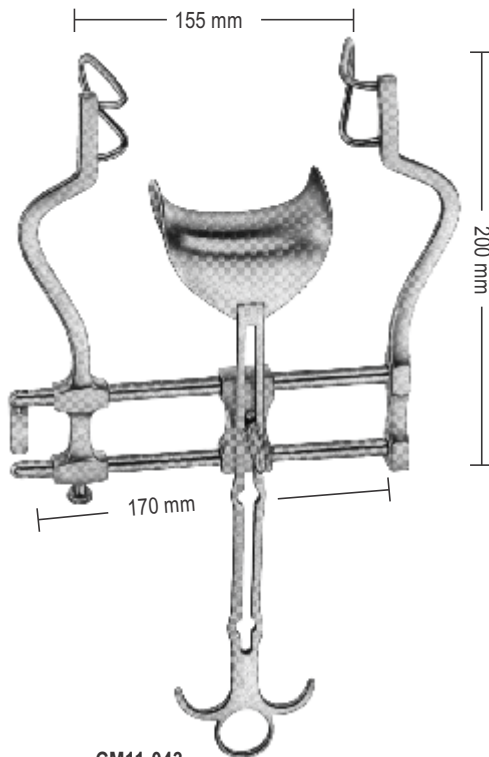

CM11-043
BALFOUR
Lateral blades 60 mm deep
Center blade 47 x 80 mm

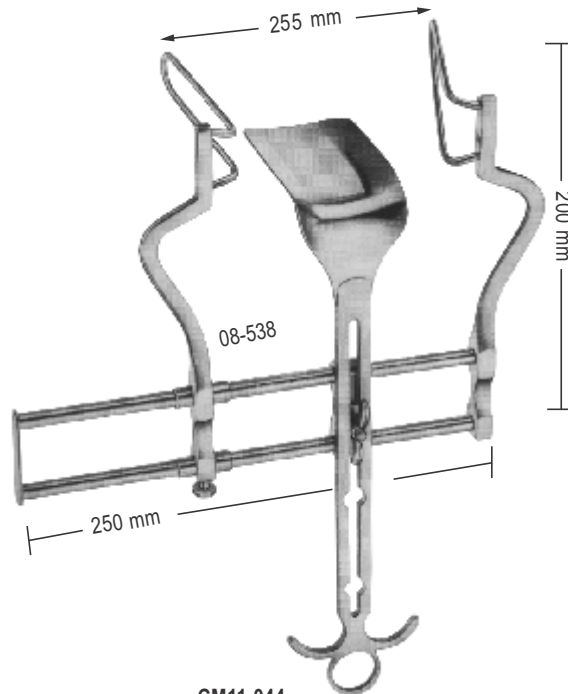

CM11-044
BALFOUR
Lateral blades 105 mm deep
Center blade 107x 59 mm

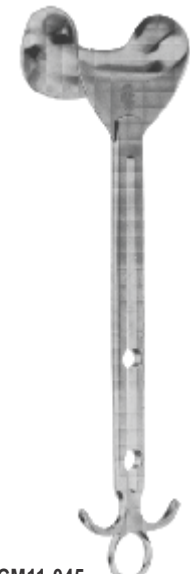

CM11-045
Center blade only
54x80 mm

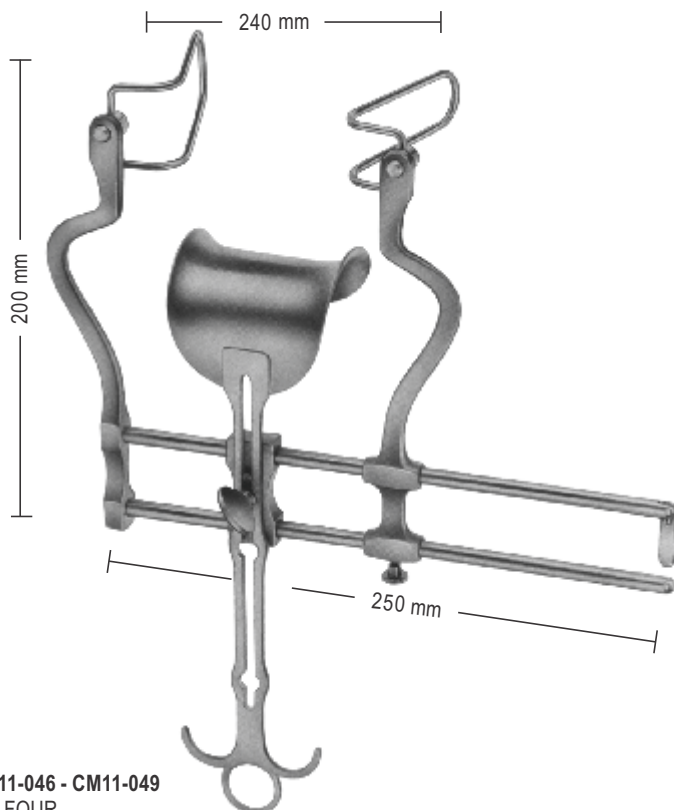

CM11-046 - CM11-049
BALFOUR
Spreader only **CM11-046** **CM11-047** **CM11-048** **CM11-049**
Lateral blades 50 mm 60 mm 75 mm 90 mm



Sales Unit of blades:PR = pair

Lateral blades
CM11-050
50 mm deep
CM11-051
60 mm deep
CM11-052
75 mm deep
CM11-053
90 mm deep



BOSE
CM11-054
60 mm



FINSEN
CM11-055
50 mm



FINSEN
CM11-056
70 mm



FINSEN modif.
CM11-057
75 mm



CM11-058
45 mm



CM11-059
55 mm



MUELLER
CM11-060
65 mm



ALM
CM11-061 7 cm
CM11-062 10 cm



JANSEN
CM11-063
100 mm



JANSEN
CM11-064
100 mm



1/2

ADSON-BABY
Blunt
CM11-065
14 cm

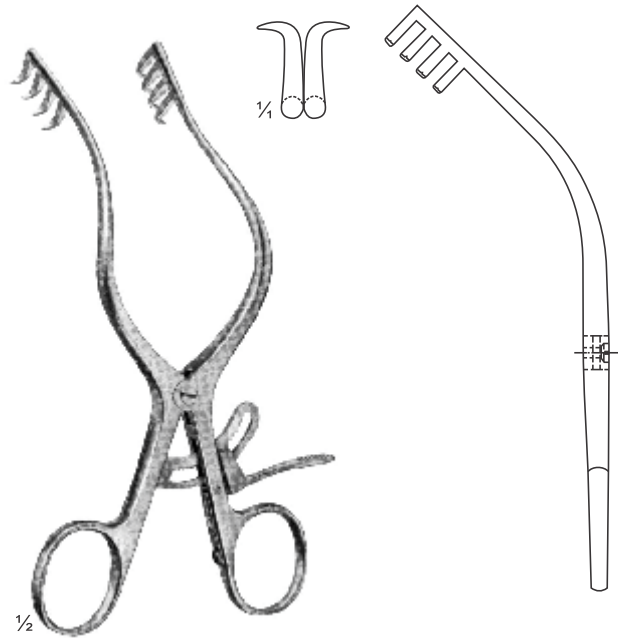

1/2

MOLLISON
Sharp
CM11-066
15.5 cm

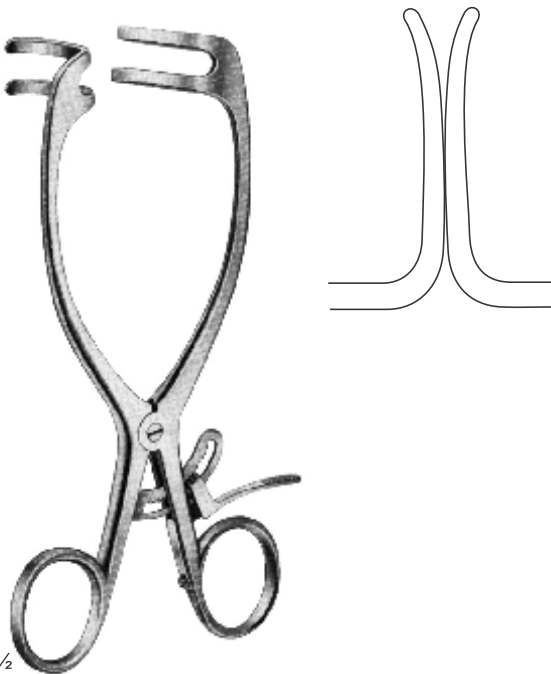

1/2

MAYO-ADAMS
CM11-067
16.5 cm



1/2

TRAVERS
CM11-068
21.5 cm

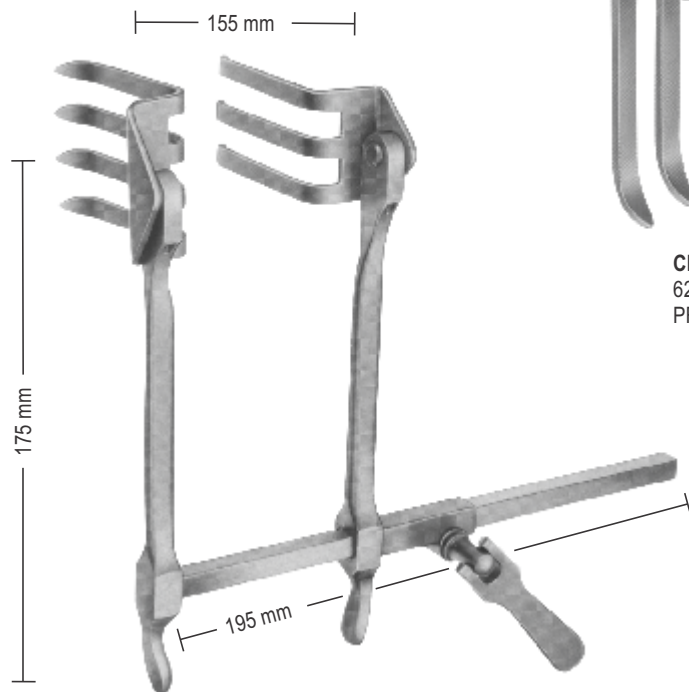

CM11-069 - CM11-072
SCOVILLE-RICHTER
 Retractor with 1 pair
 blades reversible type.
 The Retractor bar and
 shanks may be easily
 rotated 180 when
 blades are in situ.



CM11-069
 62 x 52 mm 62 x 37 mm
 PR= Pair



CM11-070
 47 x 51 mm



CM11-071
 30 x 40 mm



CM11-072
 37 x 62 mm

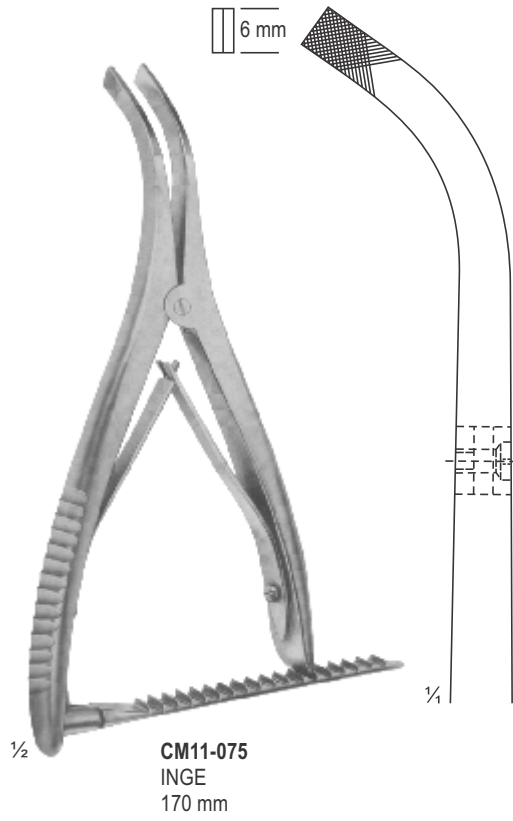
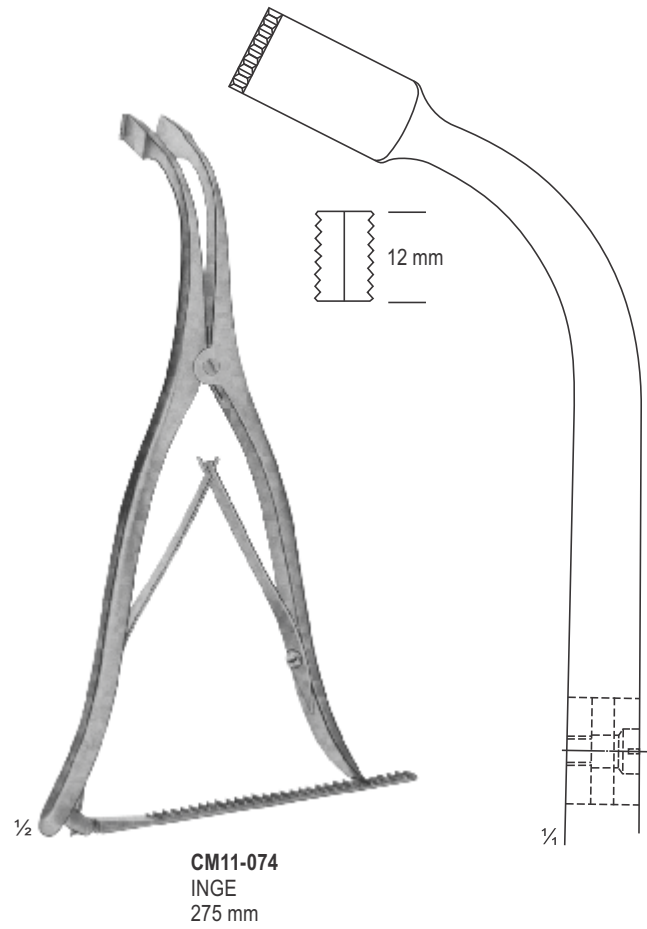
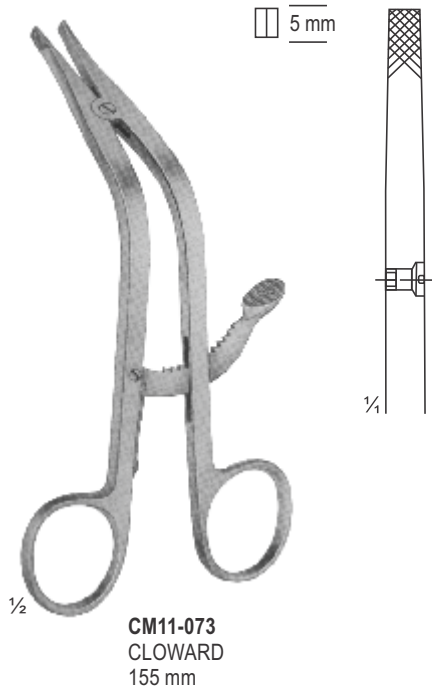



WEITLANER
Sharp
CM11-076
11 cm



WEITLANER
Semi-Sharp
CM11-077
11 cm



WEITLANER
Blunt
CM11-078
11 cm



WEITLANER
Sharp
CM11-079
13 cm



WEITLANER
Semi-Sharp
CM11-080
13 cm



WEITLANER
Blunt
CM11-081
13 cm



1/2

HENLEY
Complete with 3 Central Blades
CM11-082 - CM11-084
16.5 cm

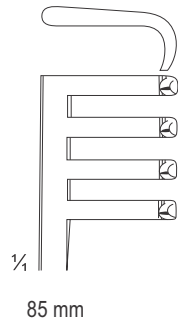

1/4

85 mm



Blades
CM11-082
19 X 17 mm

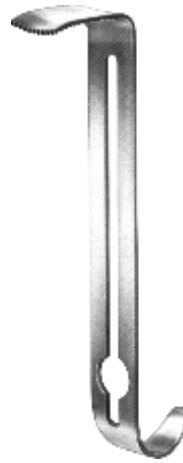

Blades
CM11-083
25 X 17 mm

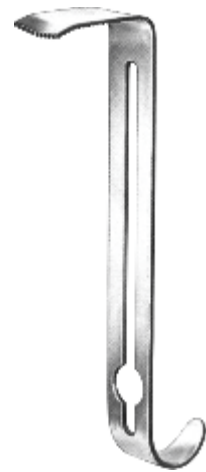

Blades
CM11-084
32 X 17 mm



JOLL (FRIEDMAN)
CM11-085
 Thyroid and Vaginal Retractor
 15.5 cm

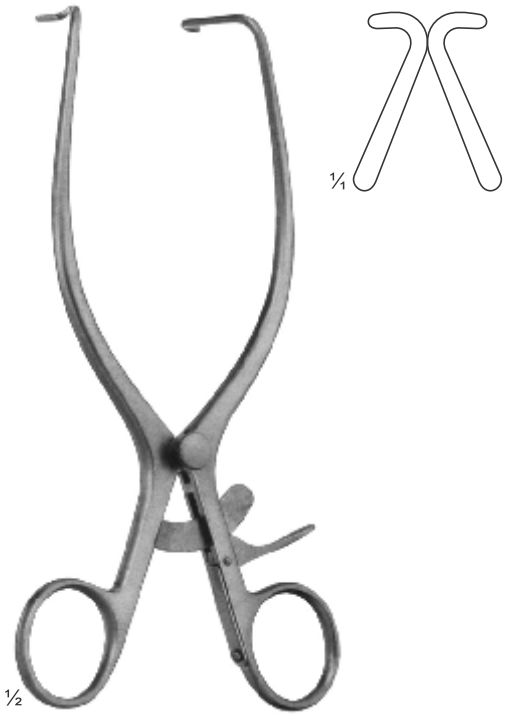

JACKSON BURROWS
CM11-086
 Retractor, blunt
 18.5 cm

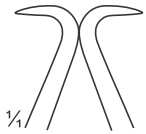

GELPI
CM11-087
 13.5 cm

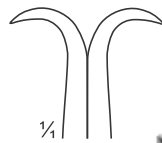

GELPI
CM11-088
 17.5 cm

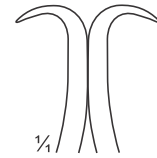

DE BAKEY
CM11-089
 14.5 cm



O'SULLIVAN-O'CONNOR
CM11-090 - CM11-092



1



2



3

Blades for
Fig. 1 = CM11-090 45 X 17 mm
Fig. 2 = CM11-091 90 X 37 mm
Fig. 3 = CM11-092 90 X 45 mm



CLOWARD modif.
Spreader Only
CM11-093 - CM11-102

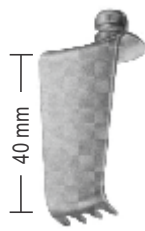

16 mm
CM11-093

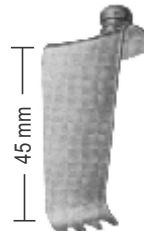

16 mm
CM11-094

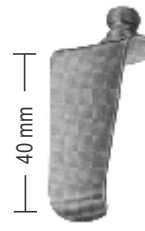

16 mm
CM11-095

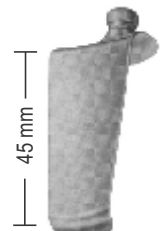

16 mm
CM11-096

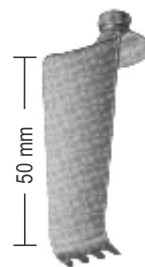

16 mm
CM11-097

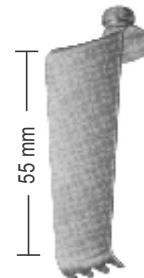

16 mm
CM11-098

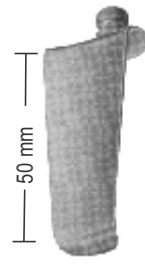

16 mm
CM11-099

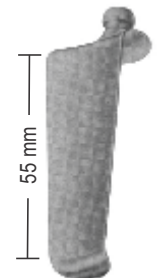

16 mm
CM11-100

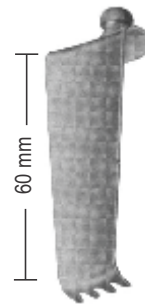

16 mm
CM11-101

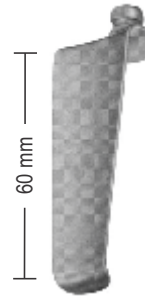

16 mm
CM11-102



CLOWARD-TYPE
CM11-103
25.5 cm
with ball snap closure Cervical Retractor
complete consisting of Retractor Body
25.5 cm, 110 mm spread (without blades)



CM11-104 - CM11-108
CM11-104 15 x 40 mm
CM11-105 15 x 45 mm
CM11-106 15 x 50 mm
CM11-107 15 x 55 mm
CM11-108 15 x 60 mm
serrated



CM11-109 - CM11-113
CM11-109 15 x 40 mm
CM11-110 15 x 45 mm
CM11-111 15 x 50 mm
CM11-112 15 x 55 mm
CM11-113 15 x 60 mm
Blunt



CONE
CM11-114 - CM11-121
CM11-114 14 cm, 18 mm 3 x 4
CM11-115 16 cm, 18 mm 3 x 4
CM11-116 20 cm, 20 mm 3 x 4
CM11-117 24 cm, 27 mm 3 x 4
CM11-118 14 cm, 18 mm 3 x 4
CM11-119 16 cm, 18 mm 3 x 4
CM11-120 20 cm, 20 mm 3 x 4
CM11-121 24 cm, 27 mm 3 x 4
 prongs blunt



MARKHAM-MEYERDING
CM11-122
 18 cm, 50 x 25 mm left
 Hemilaminectomy Retractor



MARKHAM-MEYERDING
CM11-123
 18 cm, 50 x 25 mm right
 Hemilaminectomy Retractor



MINI-WEITLANER

CM11-124 - CM11-125

CM11-124 11 cm, 16 mm 2 x 3 prongs sharp

CM11-125 11 cm, 16 mm 2 x 3 prongs blunt



WEITLANER

CM11-126 - CM11-133

CM11-126 13 cm, 18 mm 3 x 4 prongs sharp

CM11-127 16 cm, 18 mm 3 x 4 prongs sharp

CM11-128 20 cm, 21 mm 3 x 4 prongs sharp

CM11-129 25 cm, 27 mm 3 x 4 prongs sharp

CM11-130 13 cm, 18 mm 3 x 4 prongs blunt

CM11-131 16 cm, 18 mm 3 x 4 prongs blunt

CM11-132 20 cm, 21 mm 3 x 4 prongs blunt

CM11-133 25 cm, 27 mm 3 x 4 prongs blunt



ANDERSON-ADSON

Cerebellar Retractor

CM11-134 20 cm 4 x 4 prongs sharp



WEITLANER

CM11-135 - CM11-136

CM11-135 26 cm, 27 mm 5 x 6 prongs sharp

CM11-136 26 cm, 27 mm 5 x 6 prongs blunt



HEMILAMINECTOMY

CM11-137 - CM11-138

CM11-137 29 cm, 42 mm 6 x 6 prongs sharp

CM11-138 29 cm, 42 mm 6 x 6 prongs blunt



CM11-139 - CM11-142

Right blade 42 mm, left blade 22 mm deep

CM11-139 29 cm, 22/42 mm 6 x 6 prongs sharp

CM11-140 29 cm, 22/42 mm 6 x 6 prongs blunt

Right blade 22 mm, left blade 42 mm deep

CM11-141 29 cm, 22/42 mm 6 x 6 prongs sharp

CM11-142 29 cm, 22/42 mm 6 x 6 prongs blunt



SCALP CONTOUR

CM11-143 - CM11-146

- CM11-143** 14 cm, 18 mm 1 x 1 prongs blunt
- CM11-144** 14 cm, 18 mm 3 x 3 prongs blunt
- CM11-145** 14 cm, 18 mm 3 x 4 prongs sharp
- CM11-146** 14 cm, 18 mm 3 x 4 prongs blunt



BECKMANN-ADSON

CM11-147 - CM11-152

- CM11-147** 31 cm, 25 mm 4 x 4 prongs sharp
- CM11-148** 31 cm, 37 mm 4 x 4 prongs sharp
- CM11-149** 31 cm, 48 mm 4 x 4 prongs sharp
- CM11-150** 31 cm, 25 mm 4 x 4 prongs blunt
- CM11-151** 31 cm, 37 mm 4 x 4 prongs blunt
- CM11-152** 31 cm, 48 mm 4 x 4 prongs blunt



BECKMANN-EATON

CM11-153

- 32 cm, 50 mm 7 x 7 prongs sharp

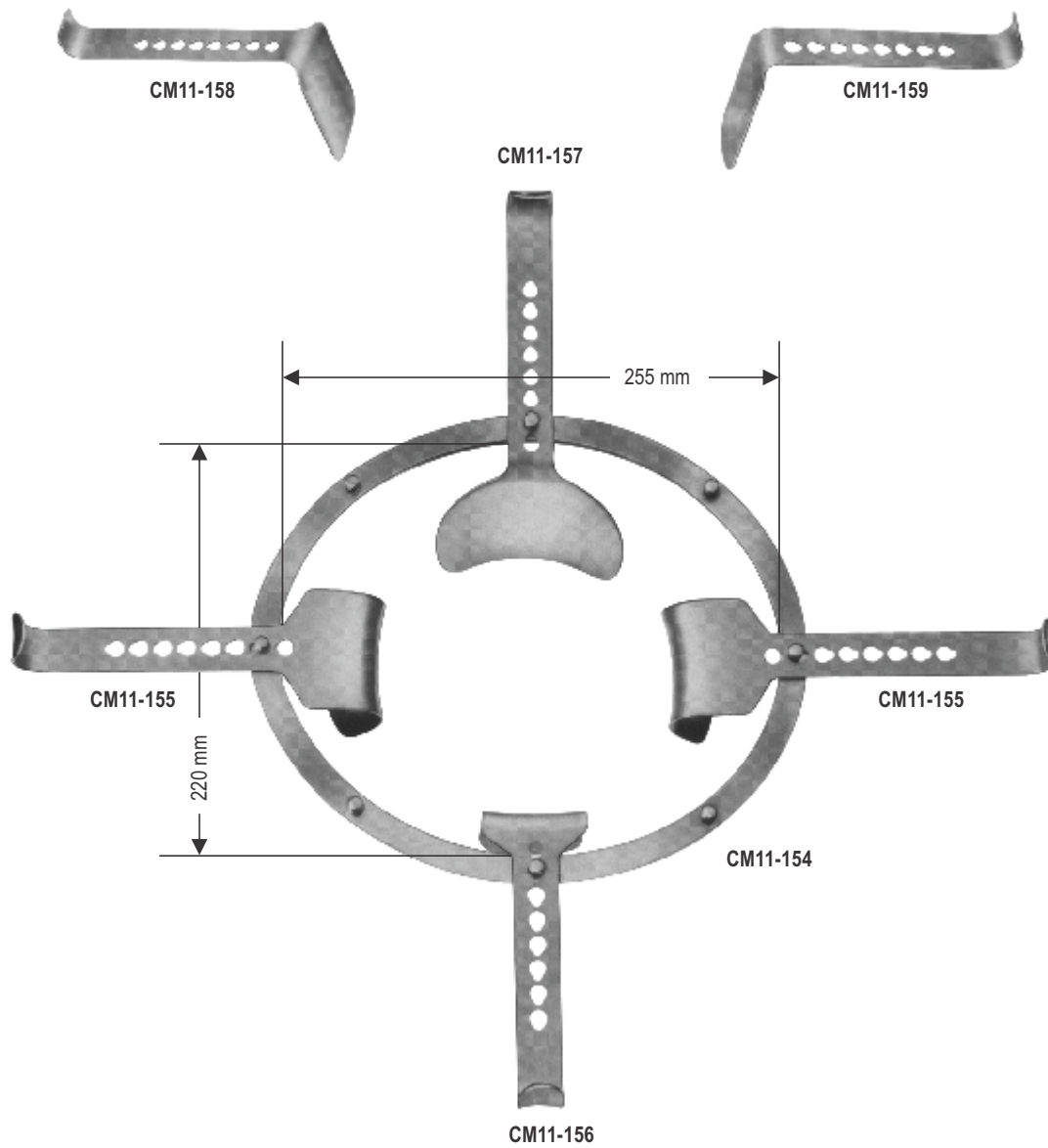

- CM11-154 - CM11-159**
 SEMM
 consisting of:
CM11-154 1 frame 225 x 220 mm
CM11-155 2 blades 46 x 64 mm
CM11-156 1 blade 53 x 54 mm
 (for bladder)
CM11-157 1 blade 82 x 97 mm
 (for intestine)
CM11-158 1 blade 98 x 51 mm
 (for intestine)
CM11-159 1 blade, narrow
 107 x 36 mm

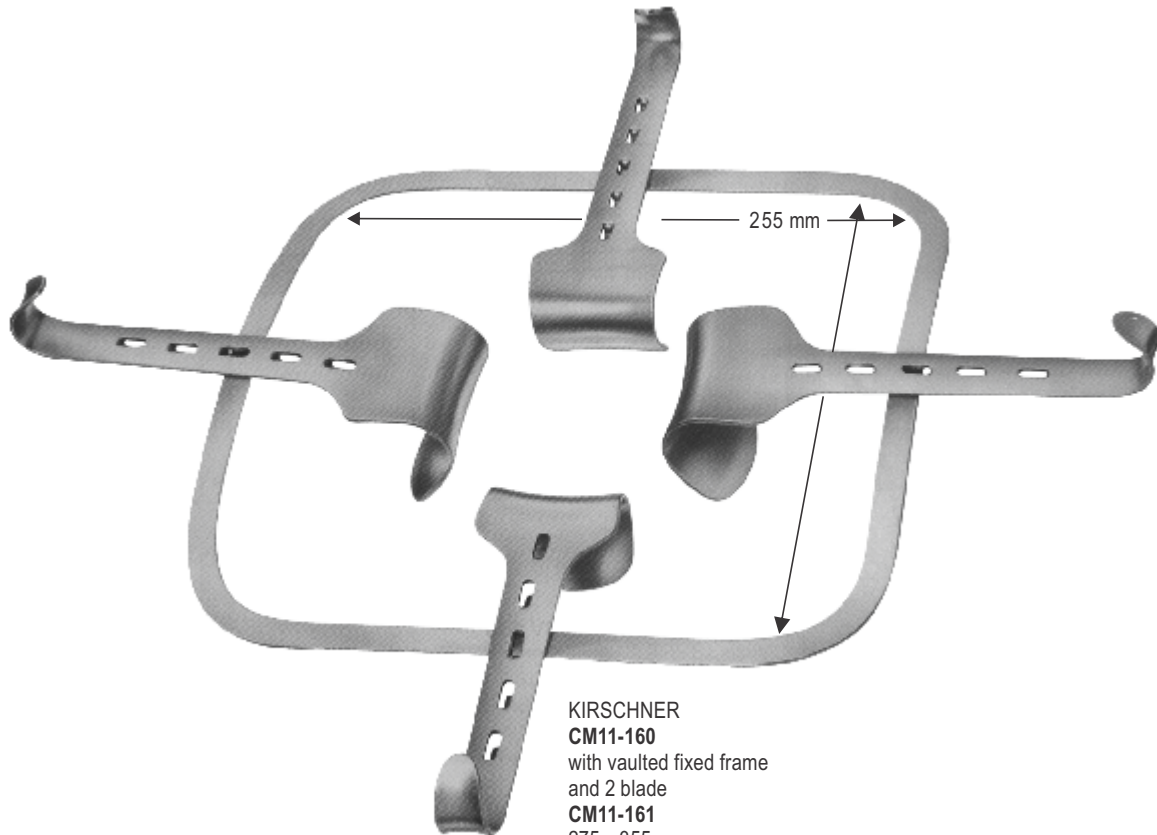

KIRSCHNER
CM11-160
with vaulted fixed frame
and 2 blade
CM11-161
275 x 355 mm
Frame only, over-sized
CM11-162
295 x 275 mm
Frame only



CM11-163
KIRSCHNER
64 x 80 mm



CM11-164
KIRSCHNER-BALFOUR
80x 82 mm

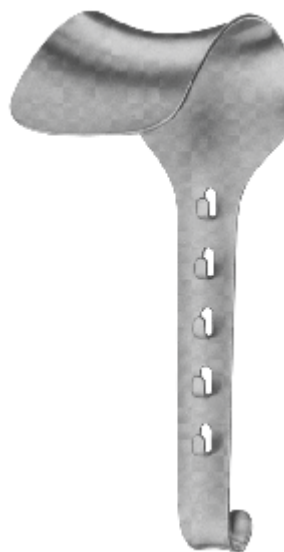

CM11-165 - CM11-167
KIRSCHNER
CM11-165 90x 69mm
CM11-166 92x 95mm
CM11-167 78x 58mm



CM11-168 - CM11-170
KIRSCHNER
CM11-168 108x42mm
CM11-169 91x 55mm
CM11-170 121x 55mm



CARE MEDICAL[®]
SUPPLIES

Your health _ Our Priority

Section

12

Page 213-247

Organ - Tissue Grasping, Dissecting And Intestinal Forceps
Sigmoid Anastomosis Forceps
Intestinal Clamps
Sigmoid Anastomosis Forceps
Biopsy Forceps And Swab Holders
Anuscopes-sphincteroscopes
Gall Duct Forceps And Choledochus Forceps
Kidney Clamps

INTESTINAL AND TISSUE GRASPING FORCEPS

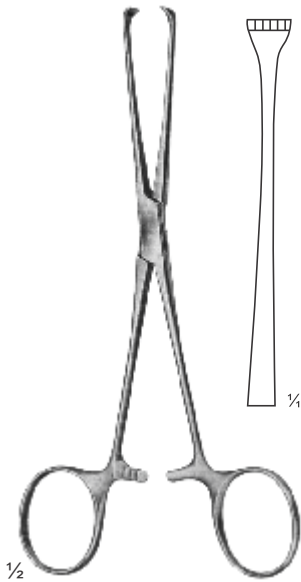

1/2

CM12-001
BOYS-ALLIS
5 X 6 teeth, sharp
155 mm,

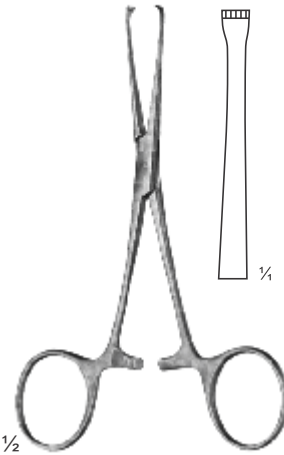

1/2

CM12-002
ALLIS
4 X 5 teeth
155 mm,

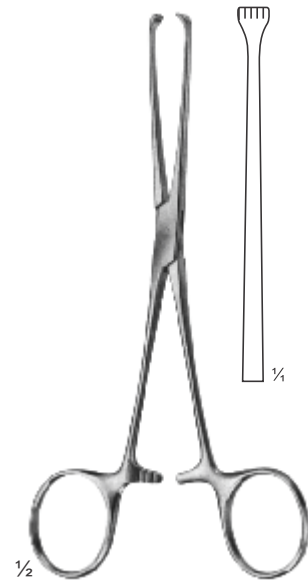

1/2

CM12-003
ALLIS
155 mm,
4 X 5 teeth

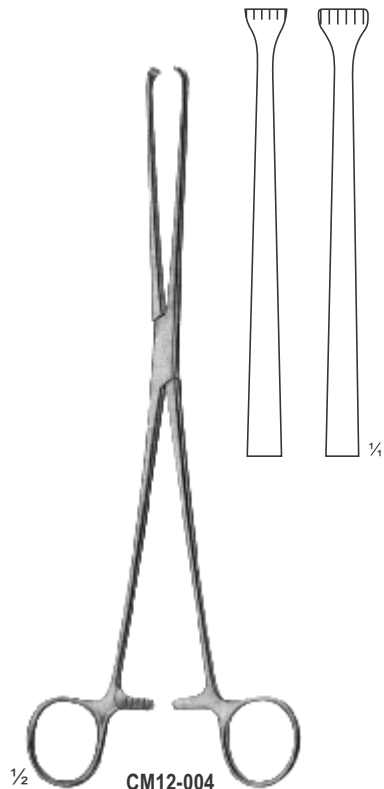

1/2

CM12-004
ALLIS
190 mm,
CM12-005
255 mm,
5 X 6 teeth

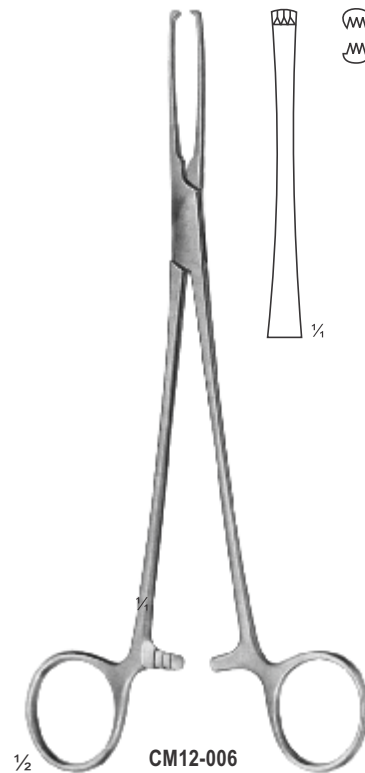

1/2

CM12-006
JUDD-ALLIS
3 X 4 teeth
195 mm,

INTESTINAL GRASPING FORCEPS

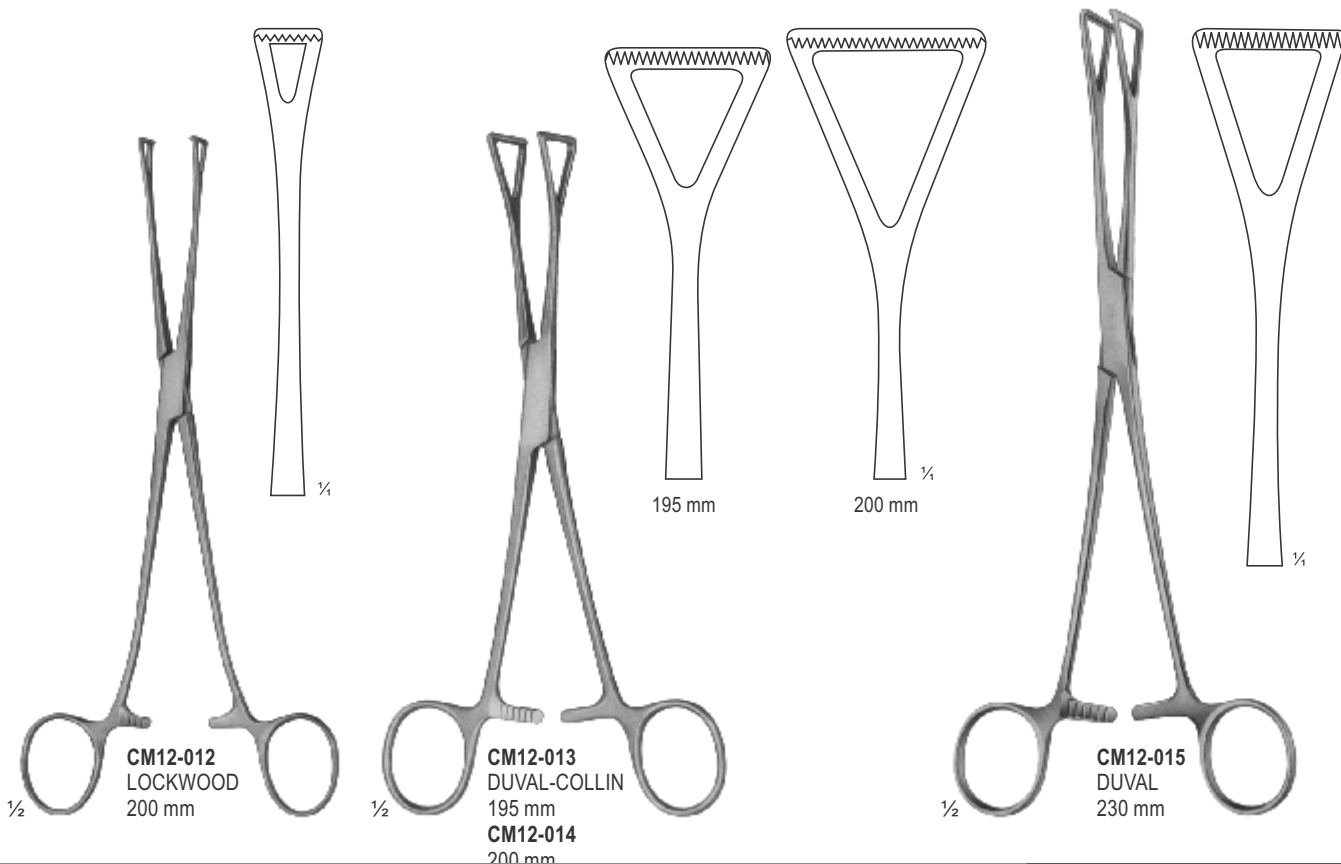
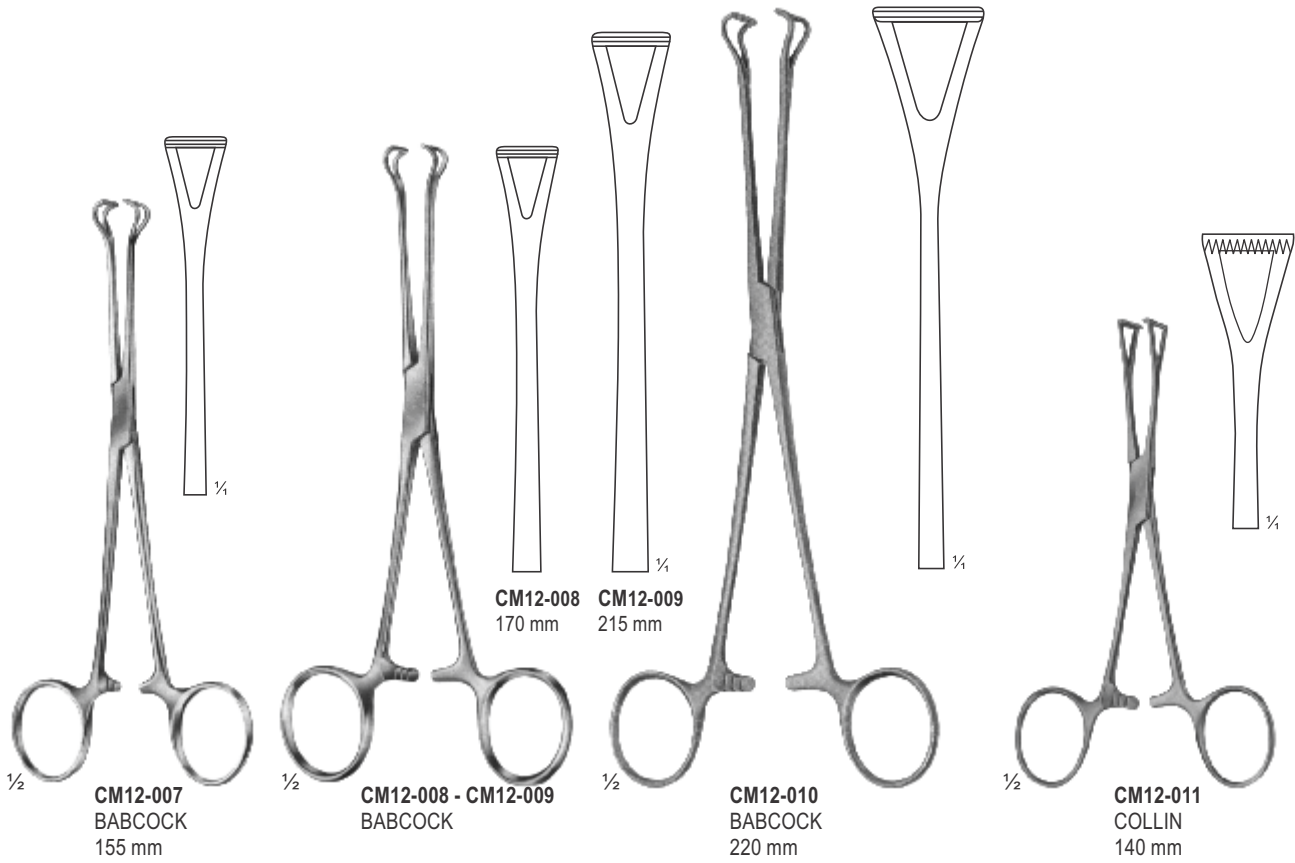

ORGAN - TISSUE GRASPING, DISSECTING AND INTESTINAL FORCEPS

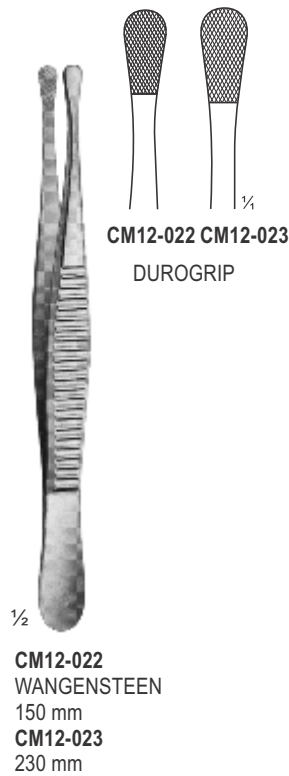
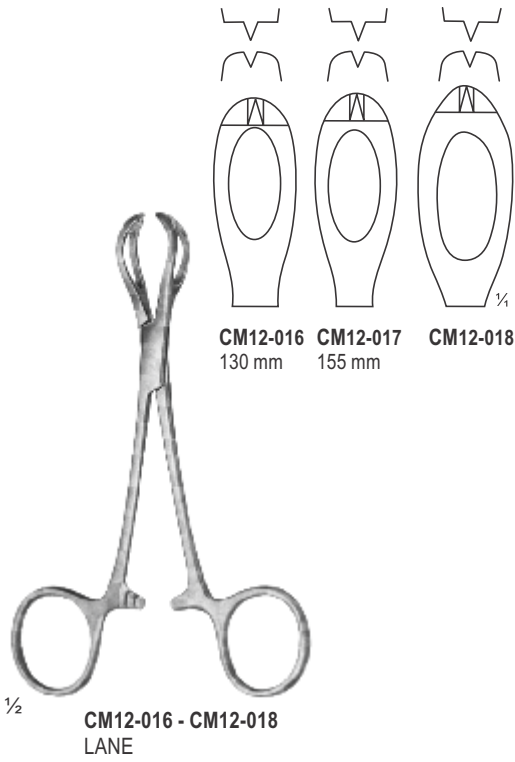

ORGAN – TISSUE GRASPING, DISSECTING AND INTESTINAL FORCEPS

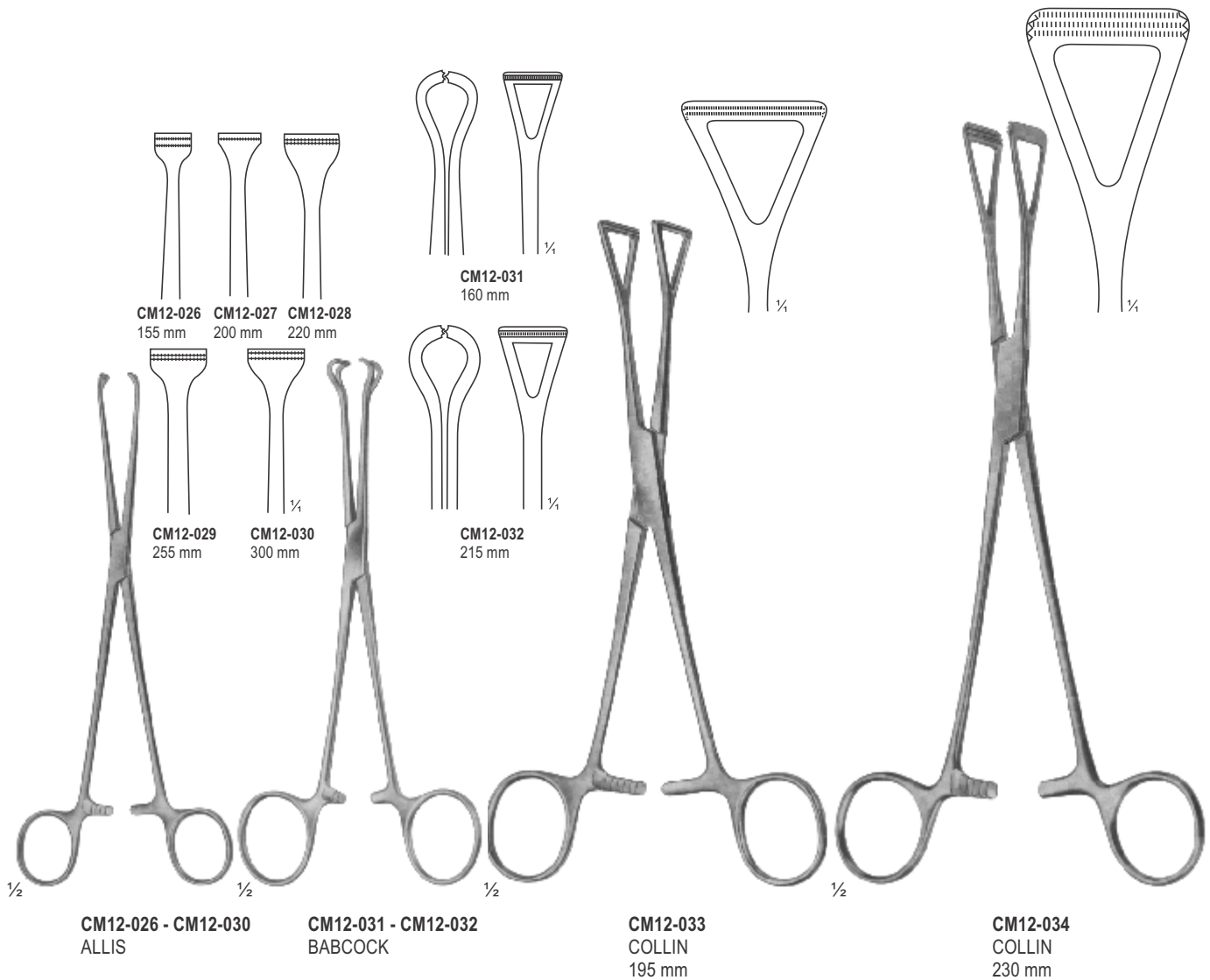

ULTRA - LIGHT - FORCEPS, DISSECTING FORCEPS

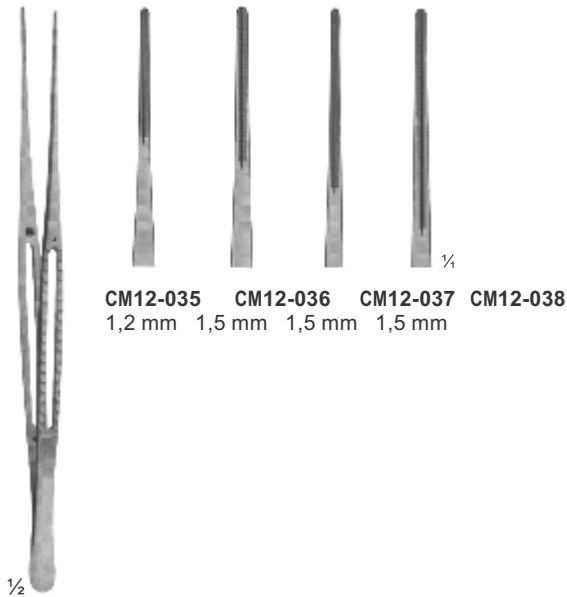

CM12-035 150 mm
CM12-036 200 mm
CM12-037 240 mm
CM12-038 300 mm

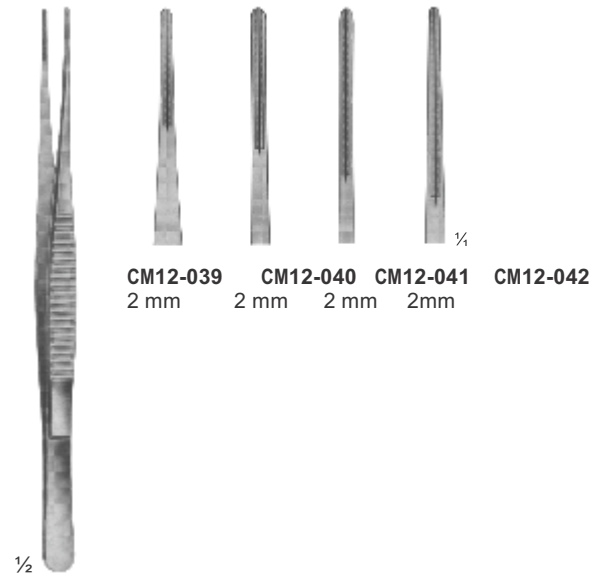

DE BAKEY
CM12-039 150 mm
CM12-040 200 mm
CM12-041 240 mm
CM12-042 300 mm

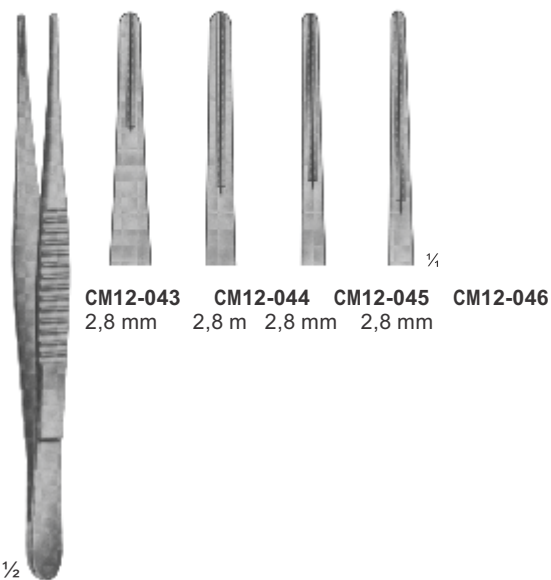

DE BAKEY
CM12-043 150 mm
CM12-044 200 mm
CM12-045 240 mm
CM12-046 300 mm

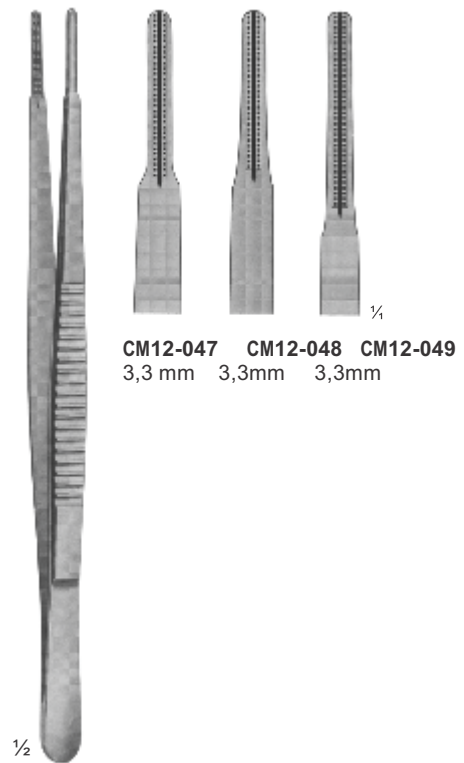

DE BAKEY
CM12-047 200 mm
CM12-048 240 mm
CM12-049 300 mm

INTESTINAL CLAMPS FOR CHILDREN

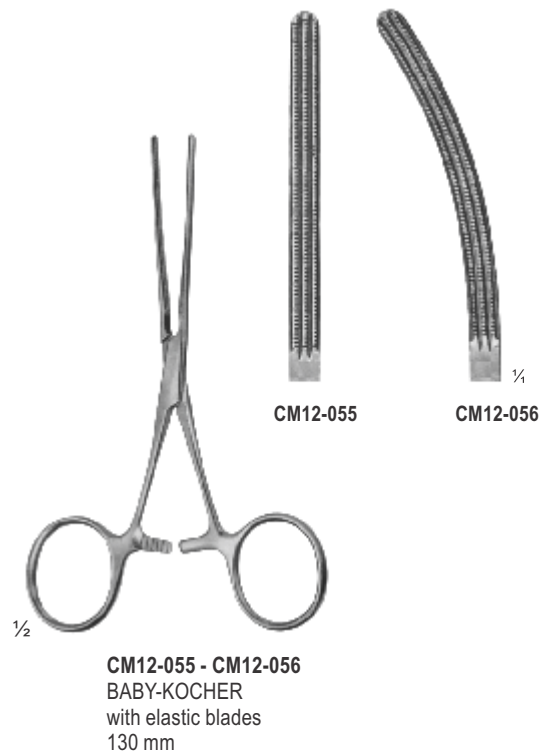
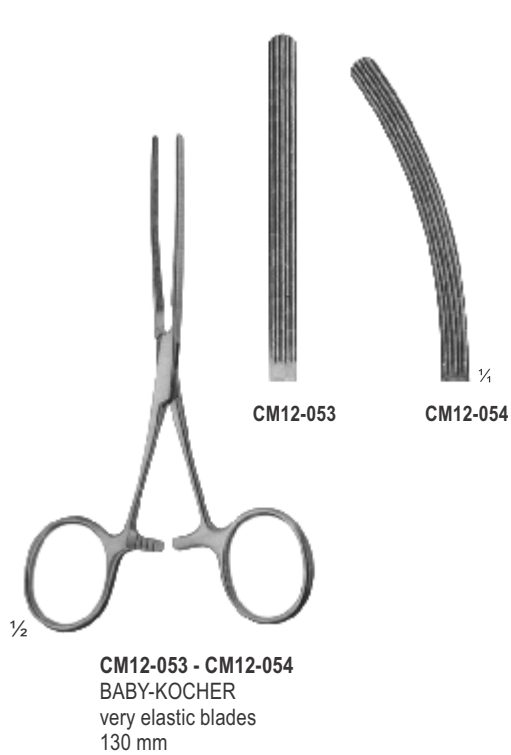
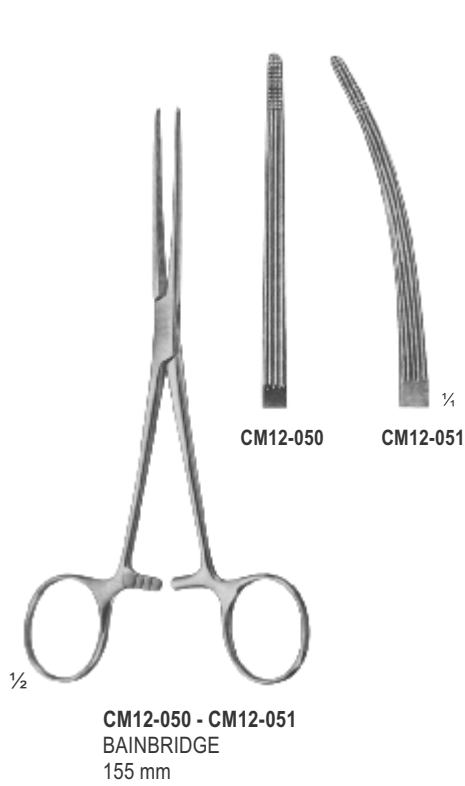

INTESTINAL CLAMPS, SOFT ELASTIC

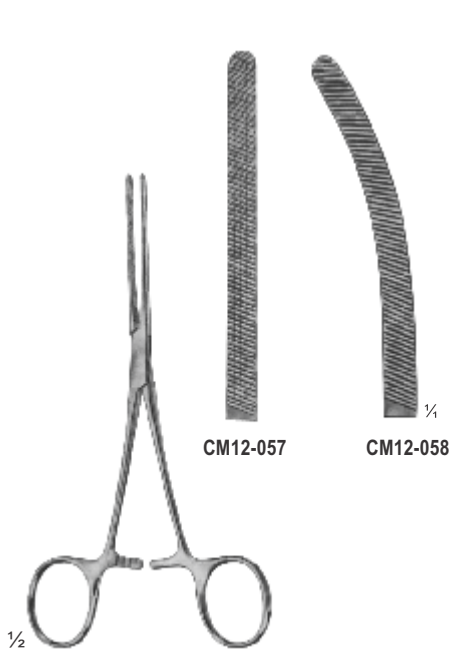

CM12-057

CM12-058

CM12-057 - CM12-058
DOYEN
elastic
165 mm

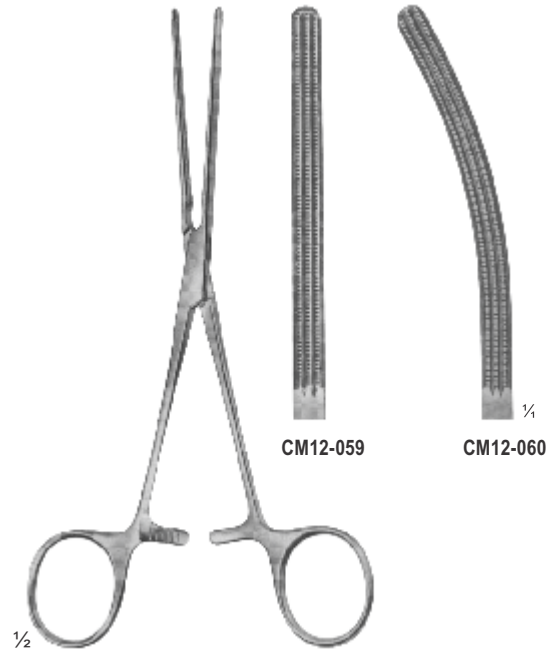

CM12-059

CM12-060

CM12-059 - CM12-060
DOYEN
with elastic blades
170 mm

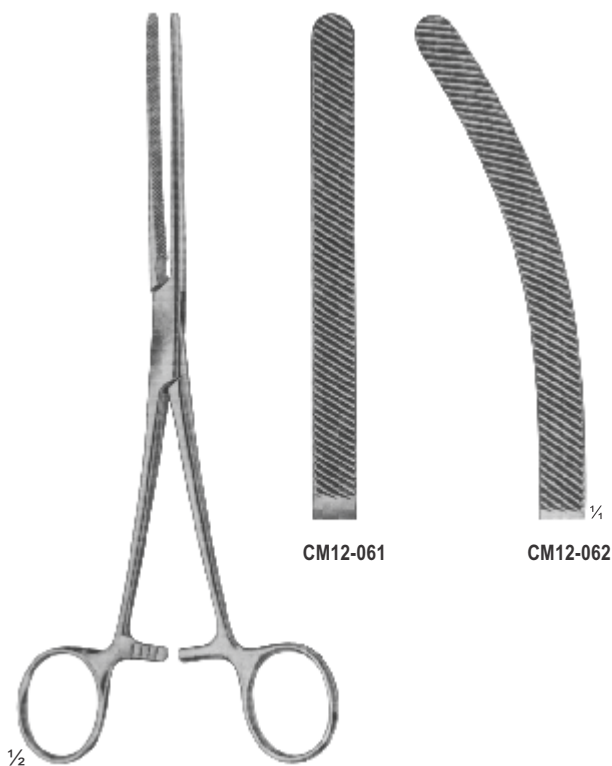

CM12-061

CM12-062

CM12-061 - CM12-062
HARTMANN
with elastic blades
200 mm

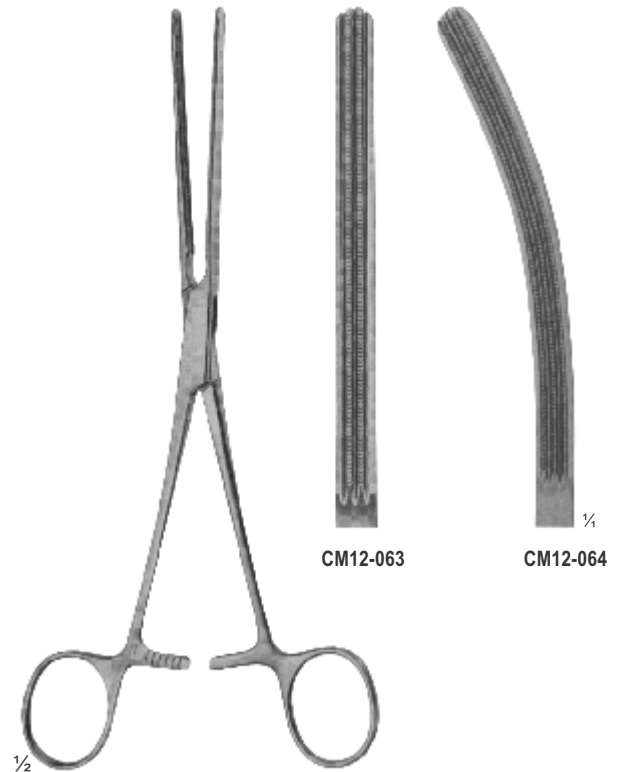

CM12-063

CM12-064

CM12-063 - CM12-064
HARTMANN
with elastic blades
200 mm

INTESTINAL CLAMPS, SOFT ELASTIC

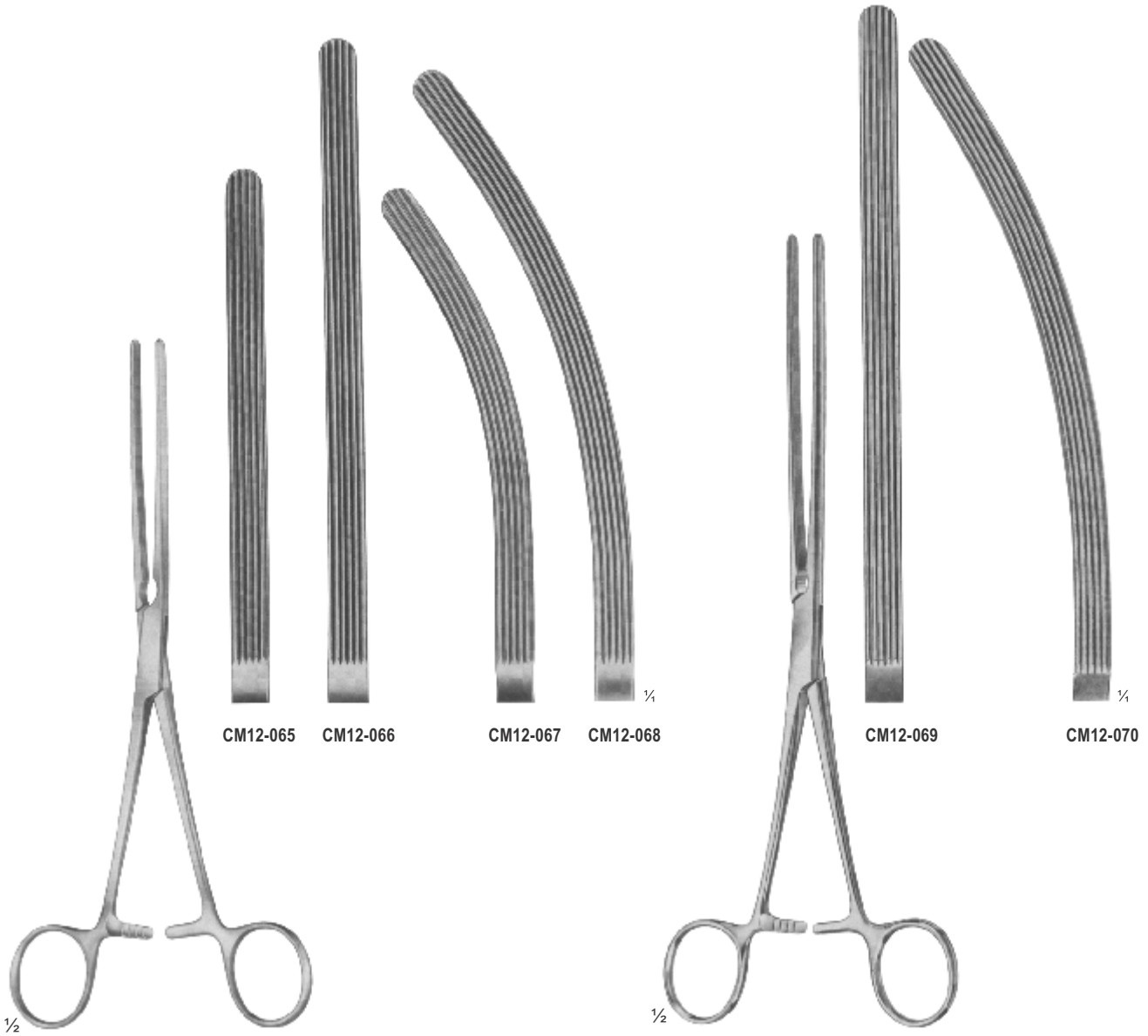

CM12-065

CM12-066

CM12-067

CM12-068

CM12-069

CM12-070

CM12-065 - CM12-068
KOCHER
with elastic blades
CM12-067 210 mm
CM12-068 230 mm

CM12-069 - CM12-070
DOYEN
with elastic blades
210 mm

INTESTINAL CLAMPS, SOFT ELASTIC



CM12-071

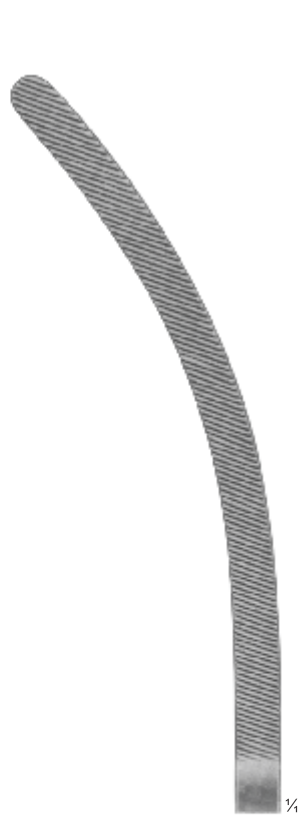

CM12-072

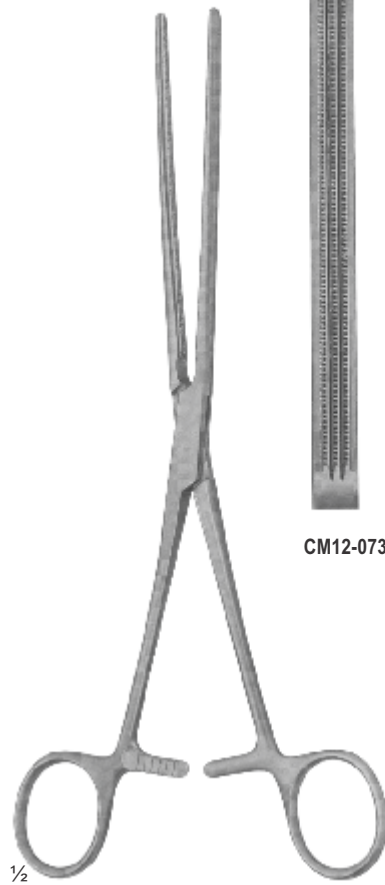

CM12-073



CM12-074

CM12-071 - CM12-072
DOYEN
with elastic blades
235 mm

CM12-073 - CM12-074
DOYEN
with elastic blades
230 mm

INTESTINAL CLAMPS, SOFT ELASTIC

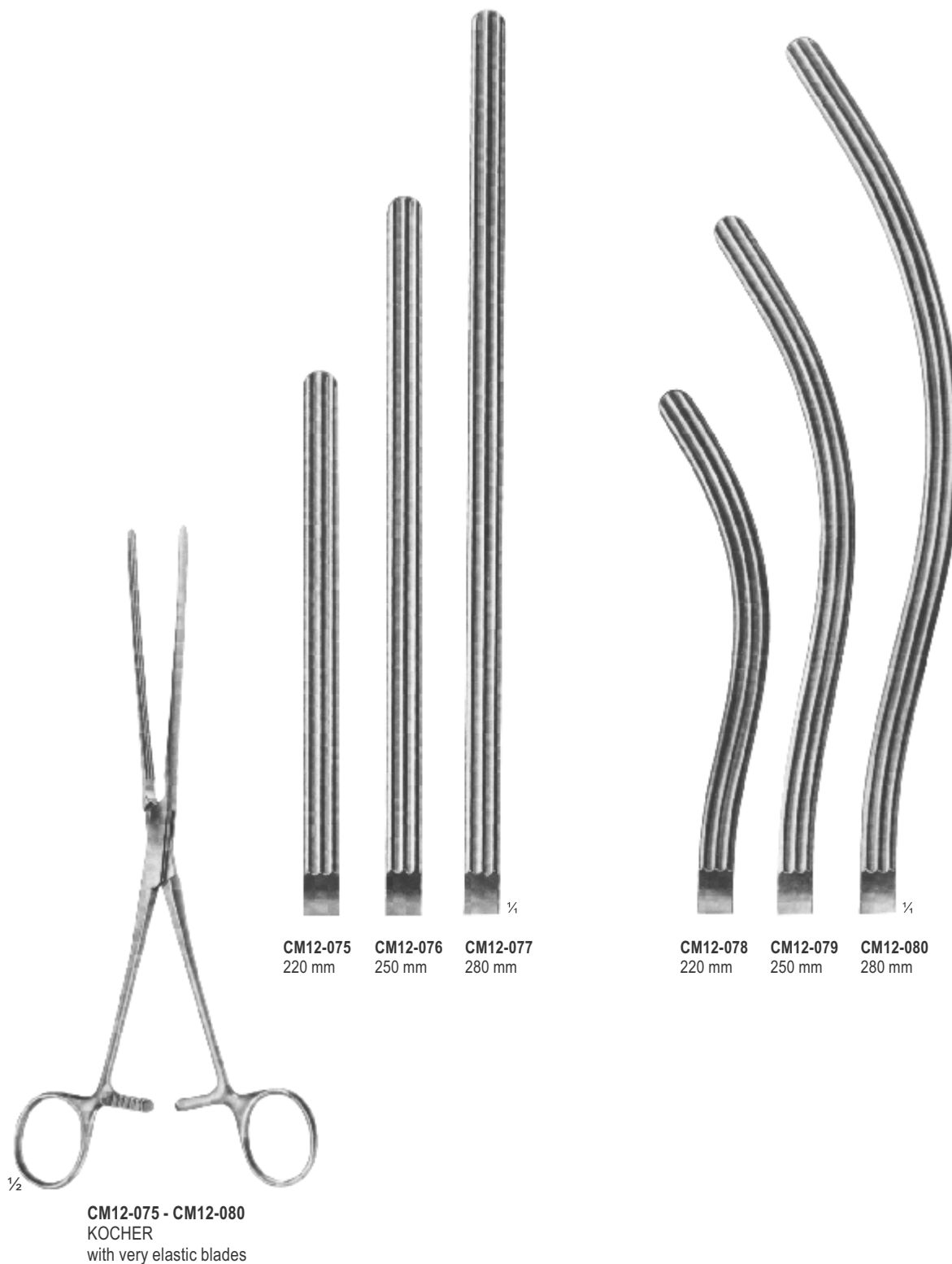

INTESTINAL CLAMPS

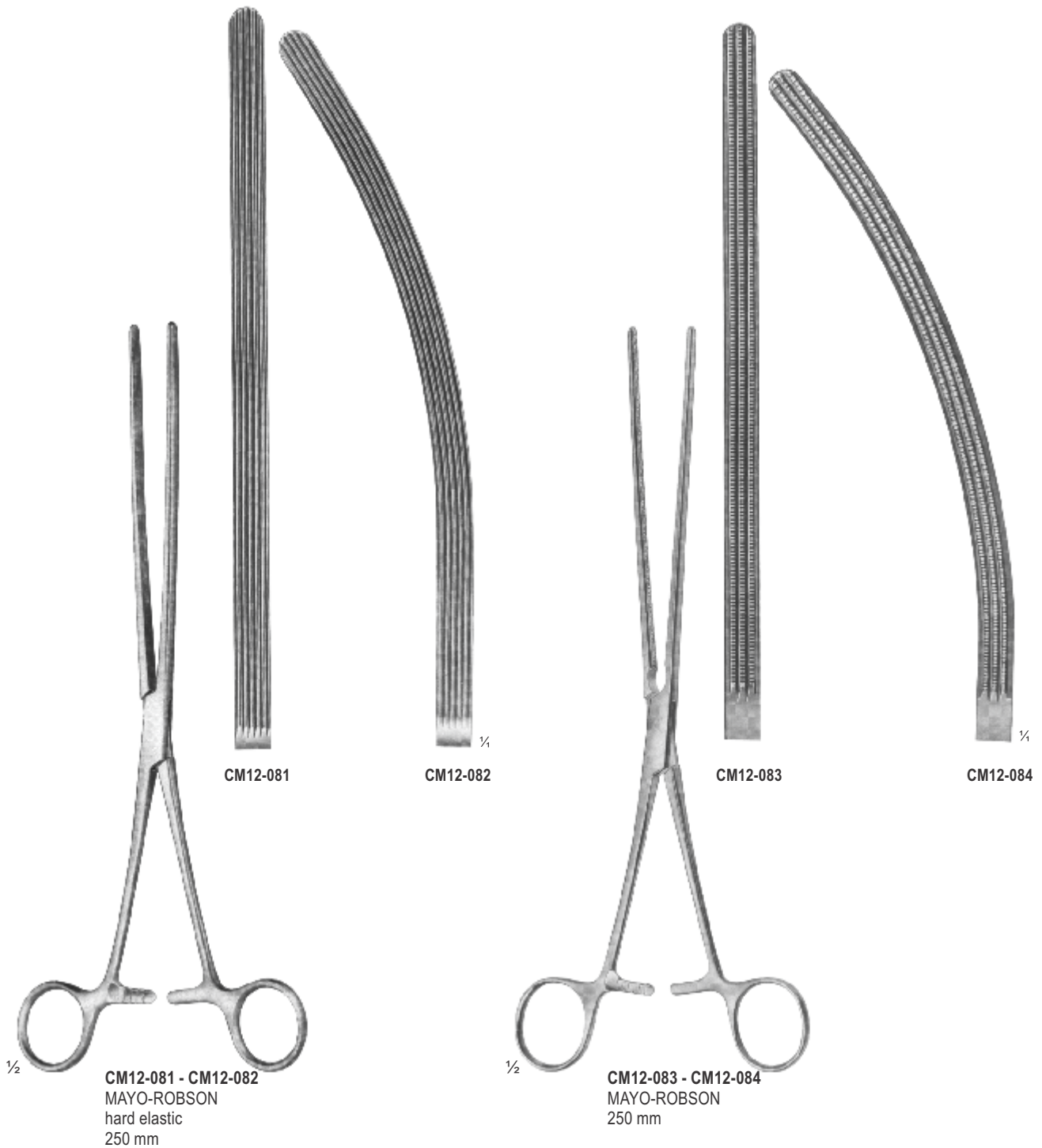

STOMACH CLAMPS



CM12-085

CM12-086

1/2 CM12-085 - CM12-086
SCUDDER
330 mm



CM12-087
KLEINSCHMIDT
Spur crushers and
Appendectomy clamps
130 mm

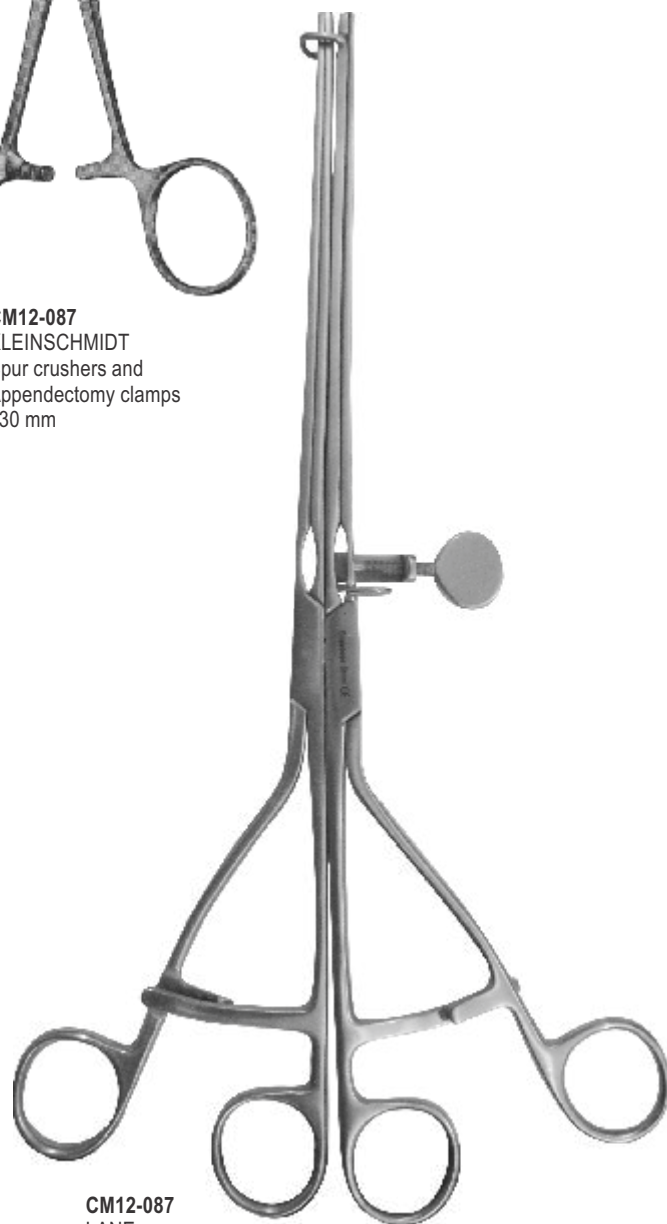

CM12-087
LANE
310 mm, 12"



CM12-088
PAYR
Intestinal clamp light
pattern, for children
180 mm

CM12-089
PAYR
200 mm

CM12-090
PAYR
275 mm

CM12-091
PAYR
Pylorus clamp
315 mm

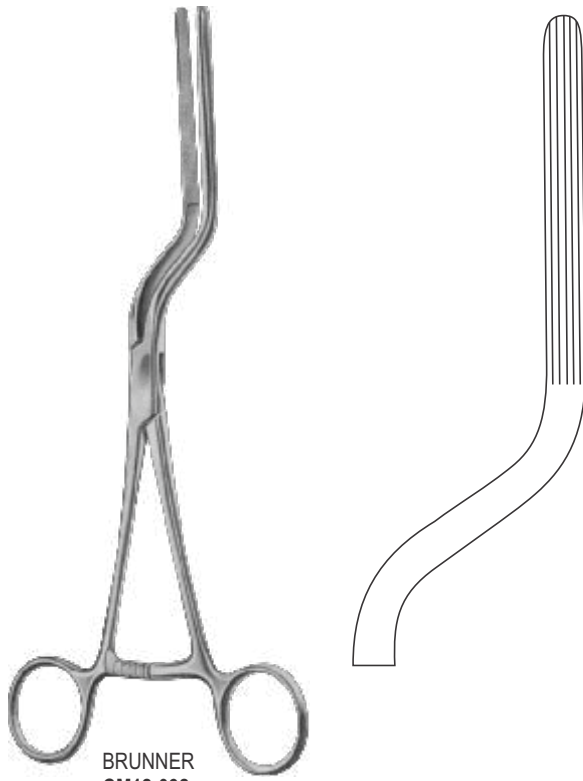

BRUNNER
CM12-092
230 mm



FEHLAND
CM12-093
240 mm



Straight

KOCHER
with very elastic blades
CM12-094 - CM12-096
CM12-094 22 cm
CM12-095 25 cm
CM12-096 28 cm

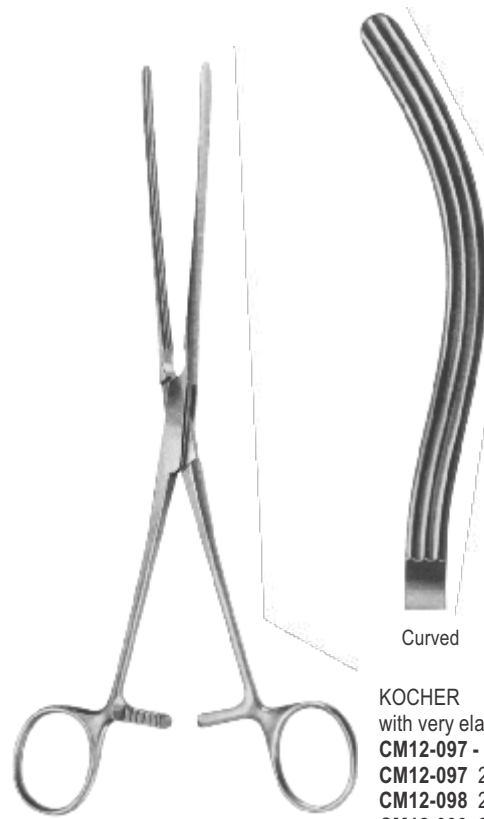

Curved

KOCHER
with very elastic blades
CM12-097 - CM12-099
CM12-097 22 cm
CM12-098 25 cm
CM12-099 28 cm

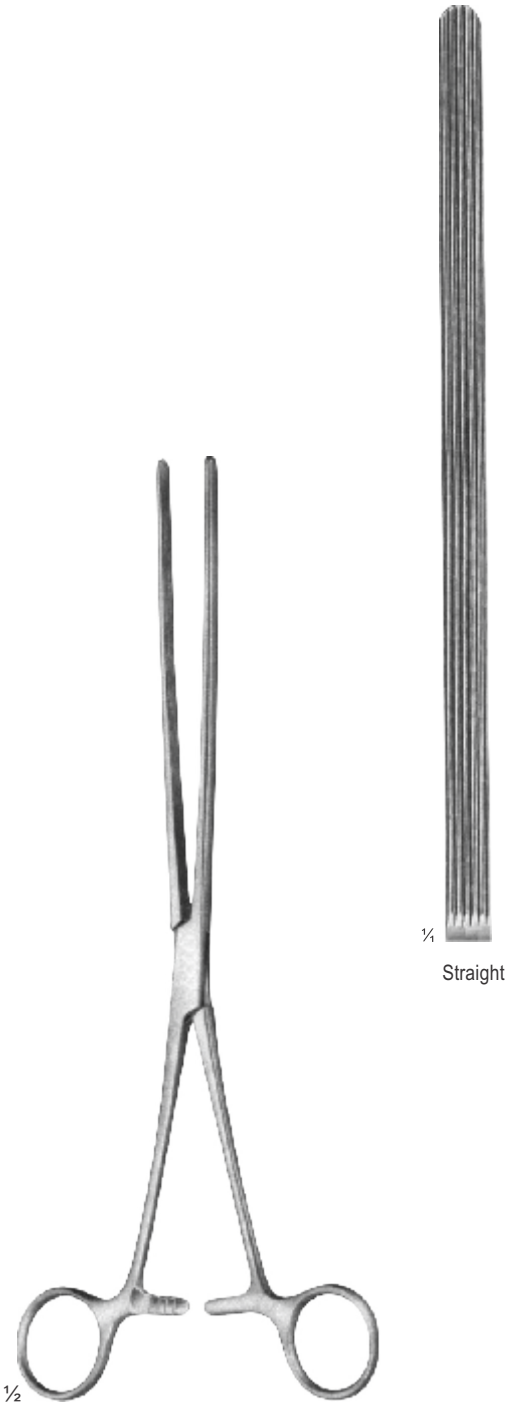

Straight

$\frac{1}{2}$

MAYO-ROBSON
CM12-100
hard elastic
250 mm

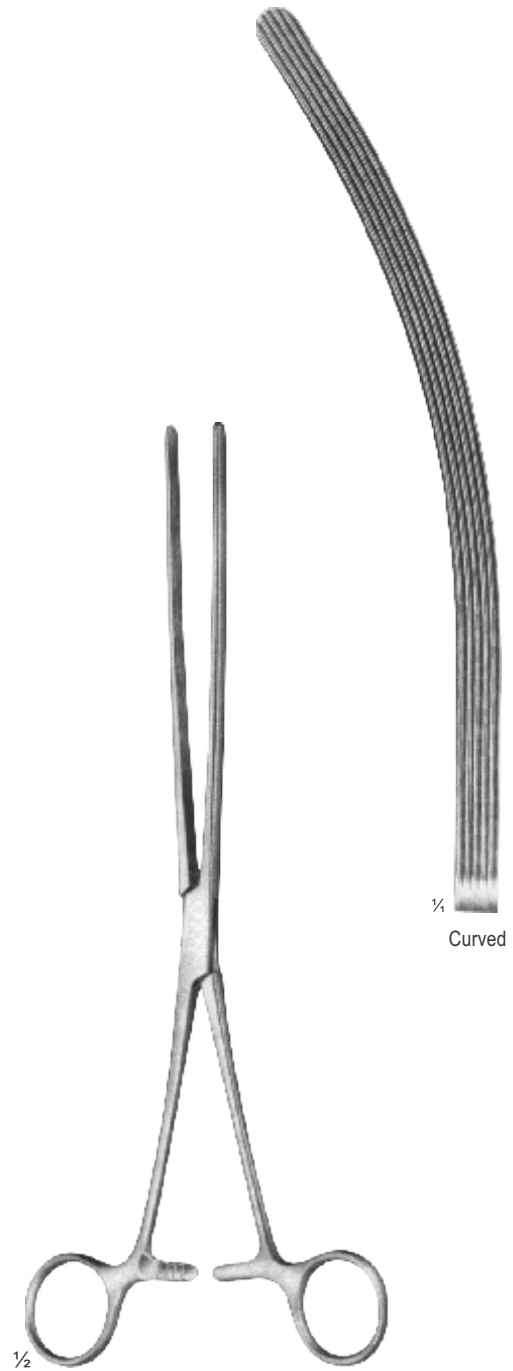

Curved

$\frac{1}{2}$

MAYO-ROBSON
CM12-101
hard elastic
250 mm

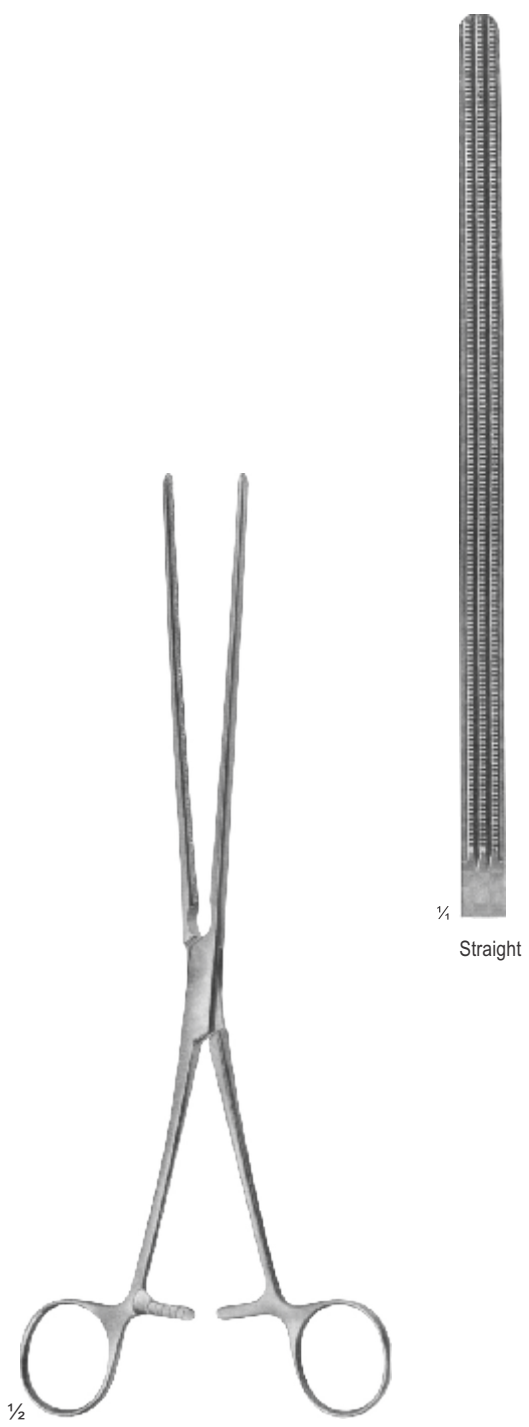

MAYO-ROBSON
CM12-102
250 mm

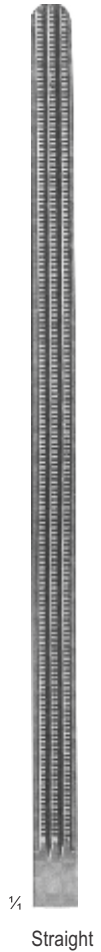

Straight

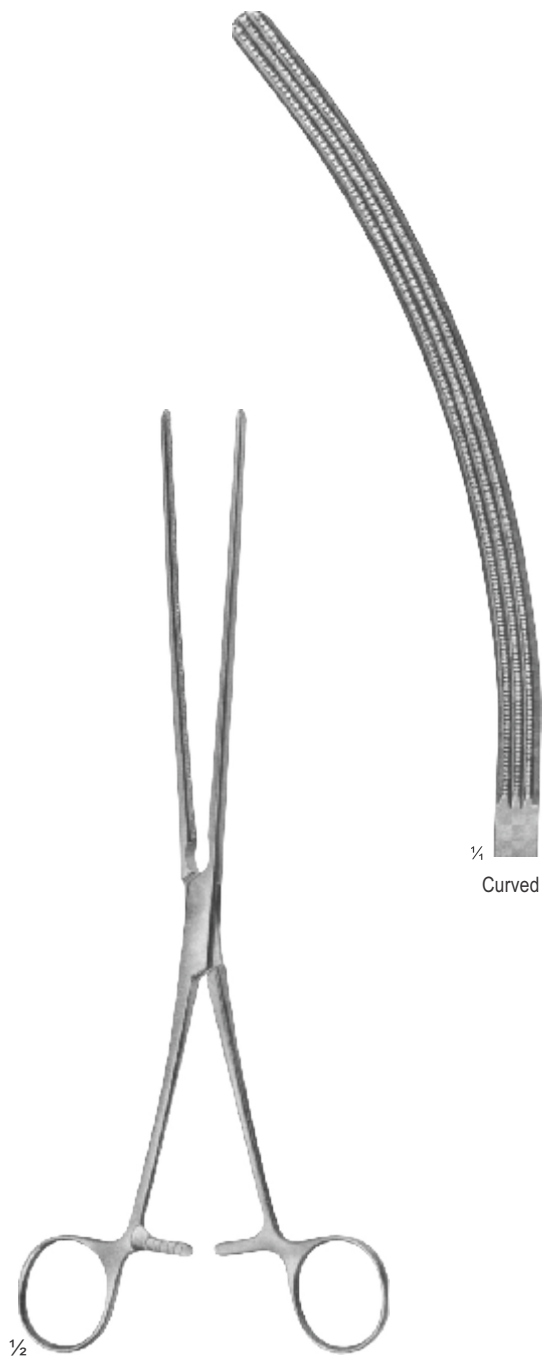

MAYO-ROBSON
CM12-103
250 mm



Curved

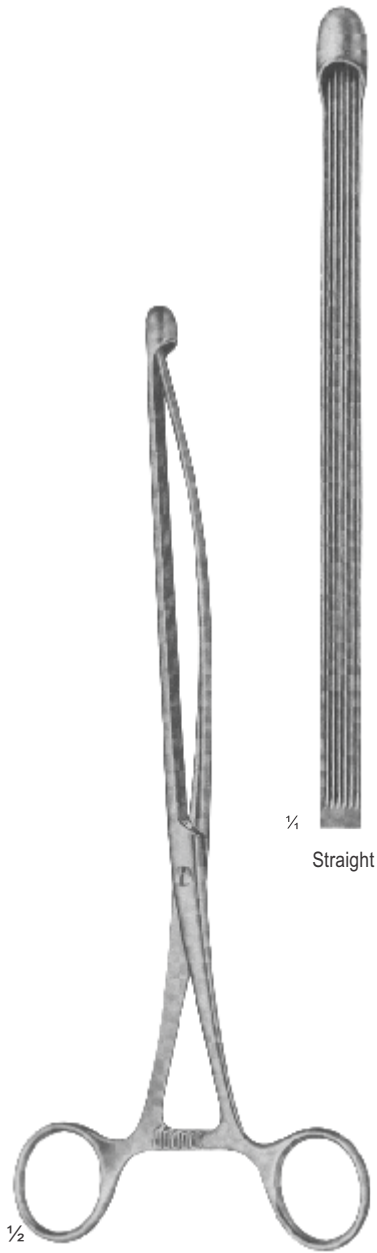

1/4
Straight

1/2
NUSSBAUM
CM12-104
with elastic blades
250 mm

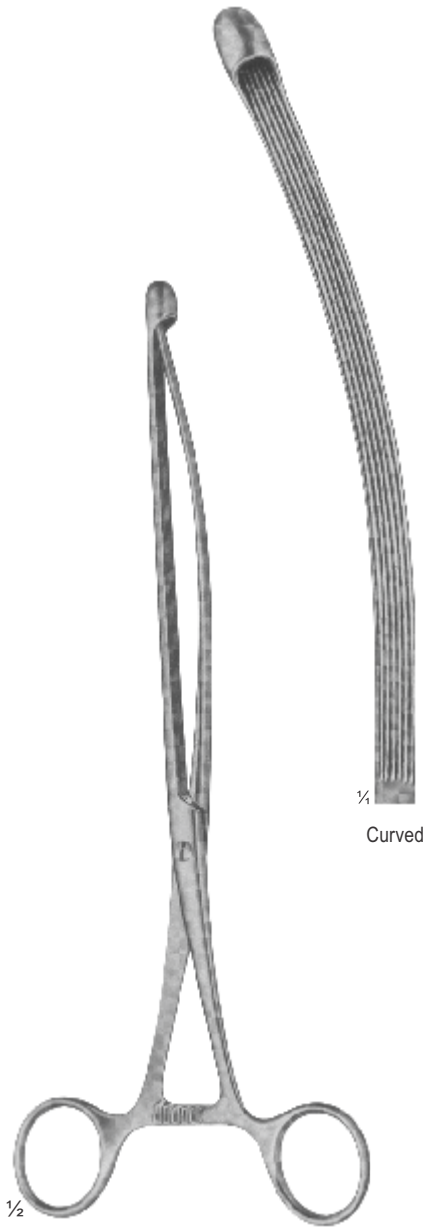

1/4
Curved

1/2
NUSSBAUM
CM12-105
with elastic blades
250 mm

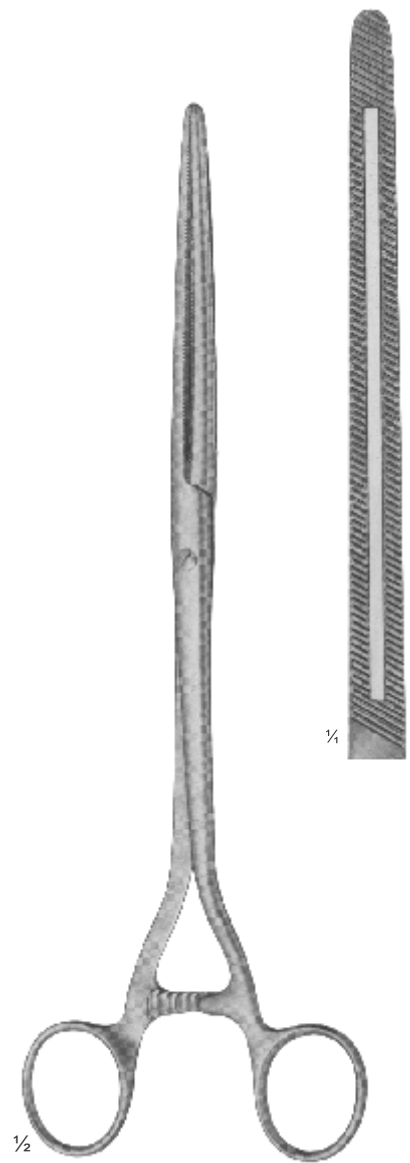

1/4

1/2
MOYNIHAN
CM12-106
280 mm

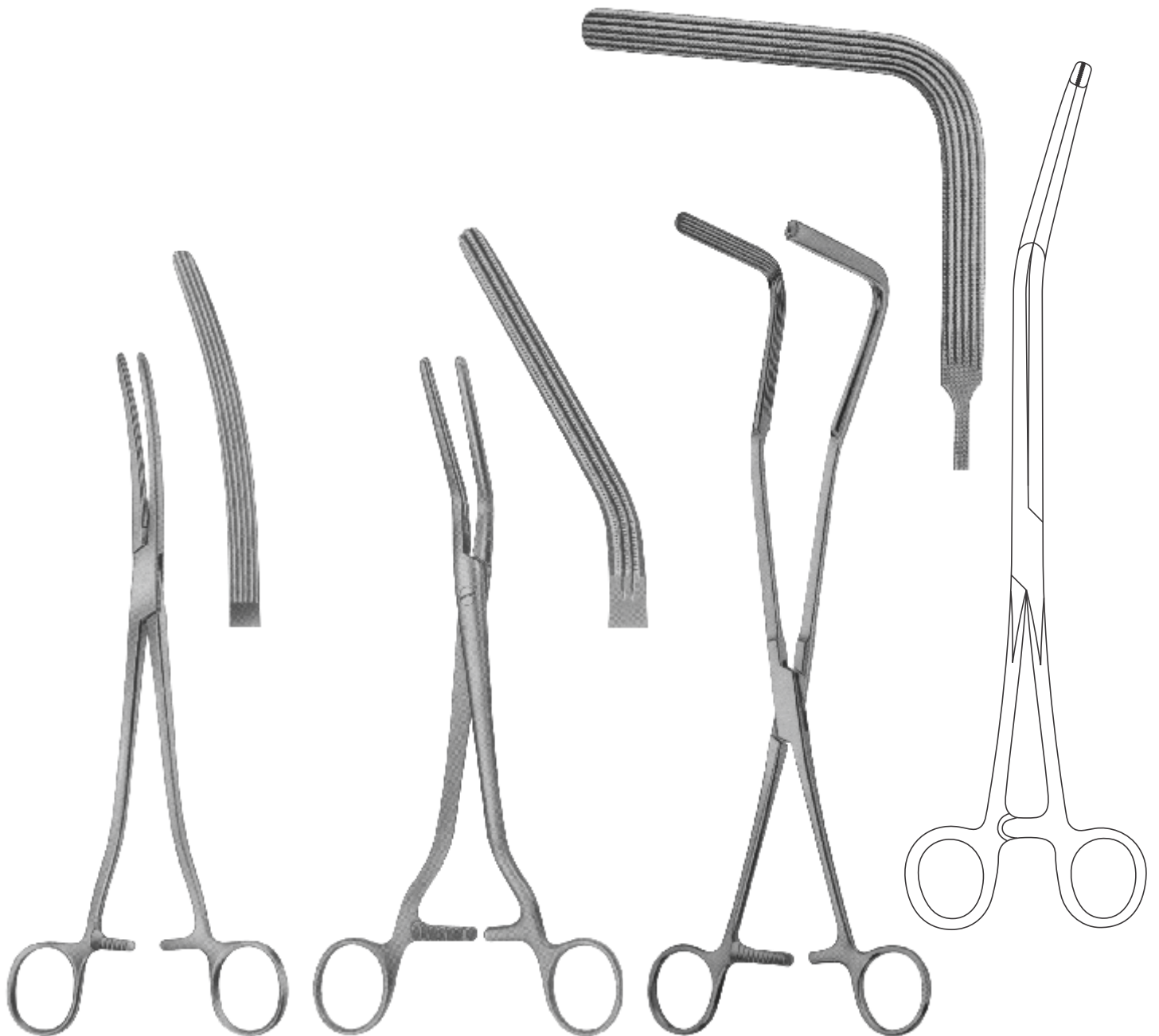

PARKER-KERR
CM12-107
anastomosis forceps
for colon resection
180 mm

DICK
pressure clamps
CM12-108 - CM12-111
CM12-108 180 mm
CM12-109 255 mm
CM12-110 265 mm
CM12-111 275 mm

LLOYD-DAVIS
CM12-112
315 mm

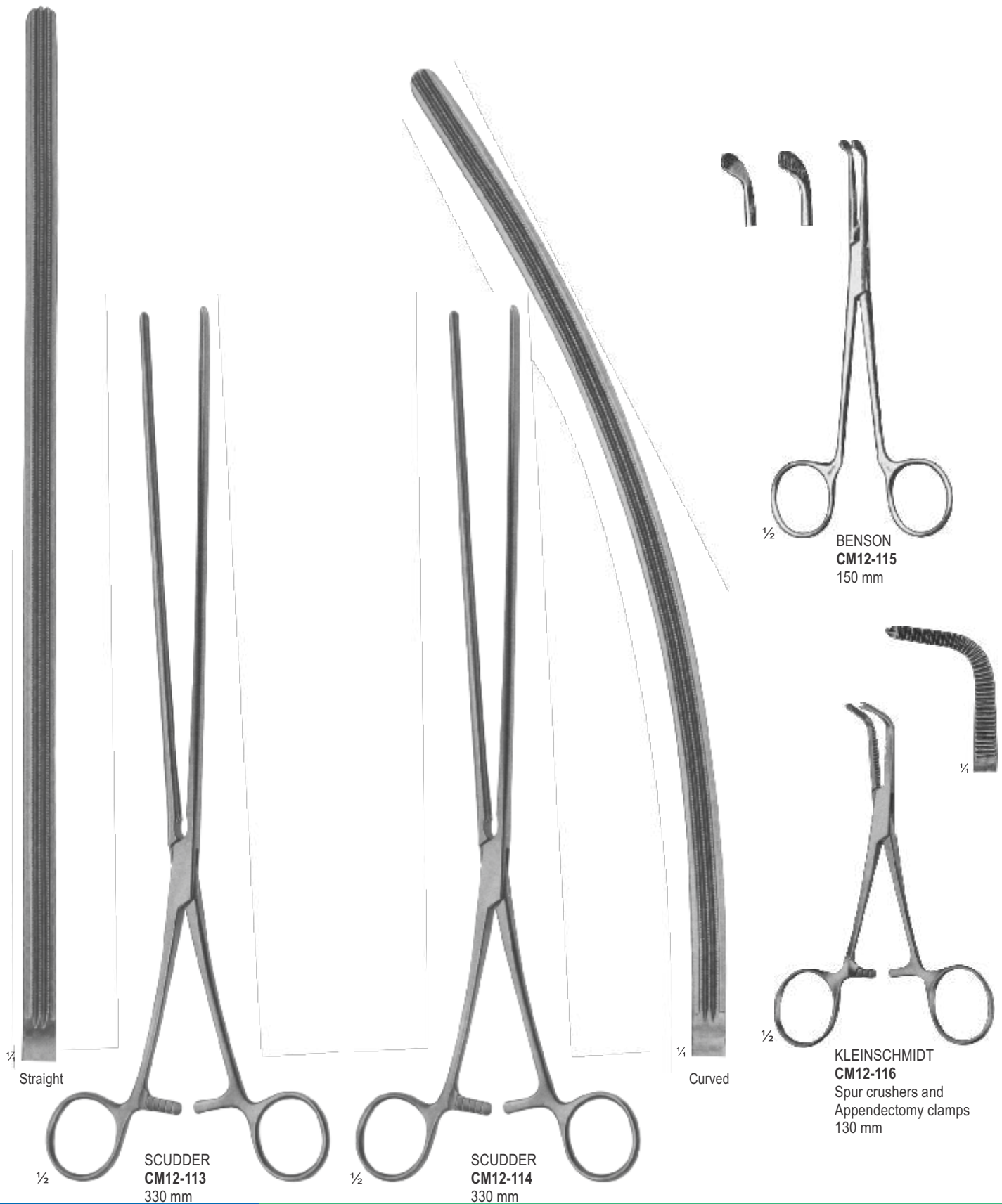

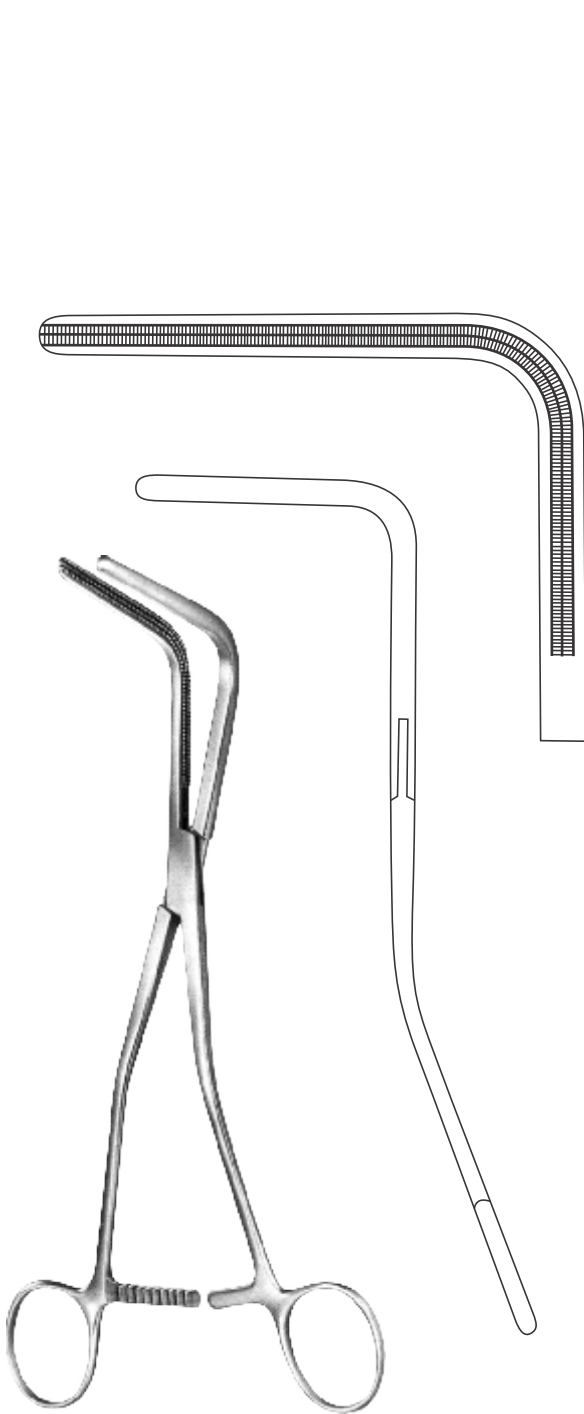

VEIDENHEIMER
CM12-117
250 mm

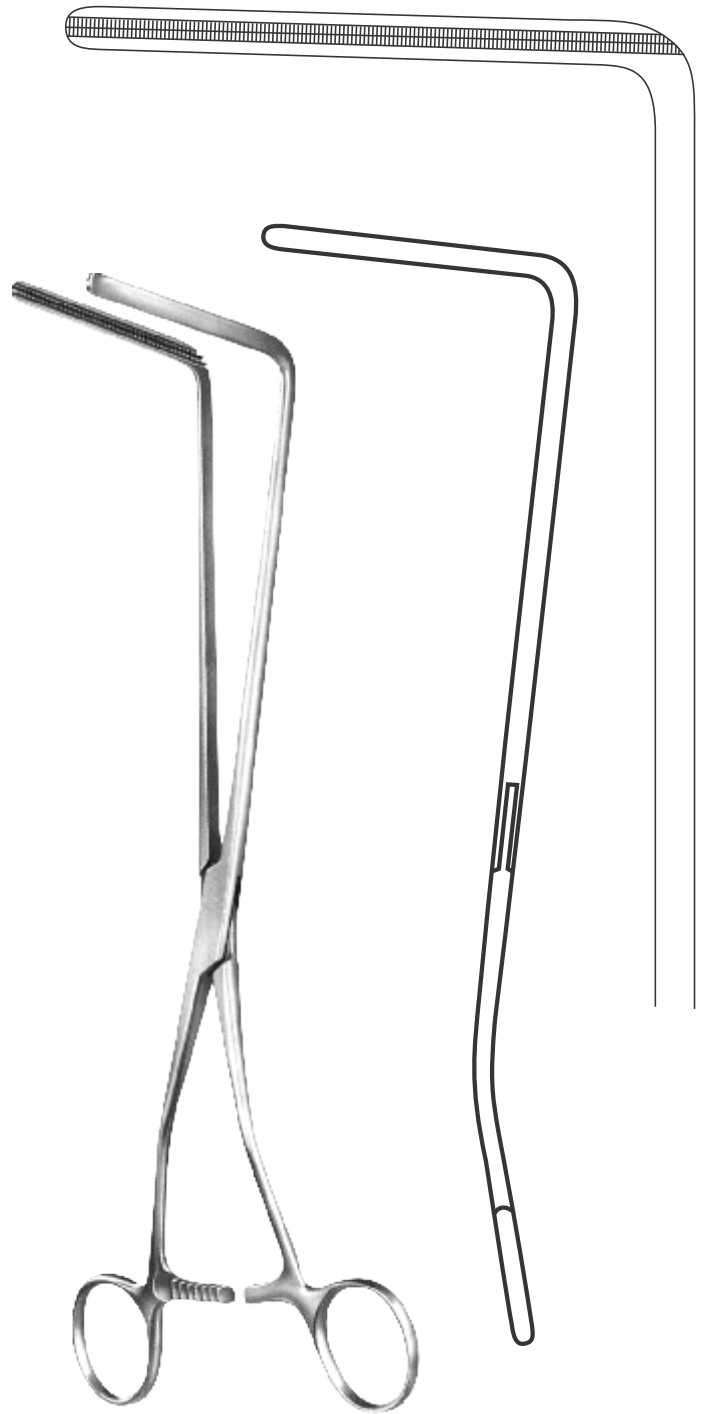

RESANO
CM12-118
280 mm

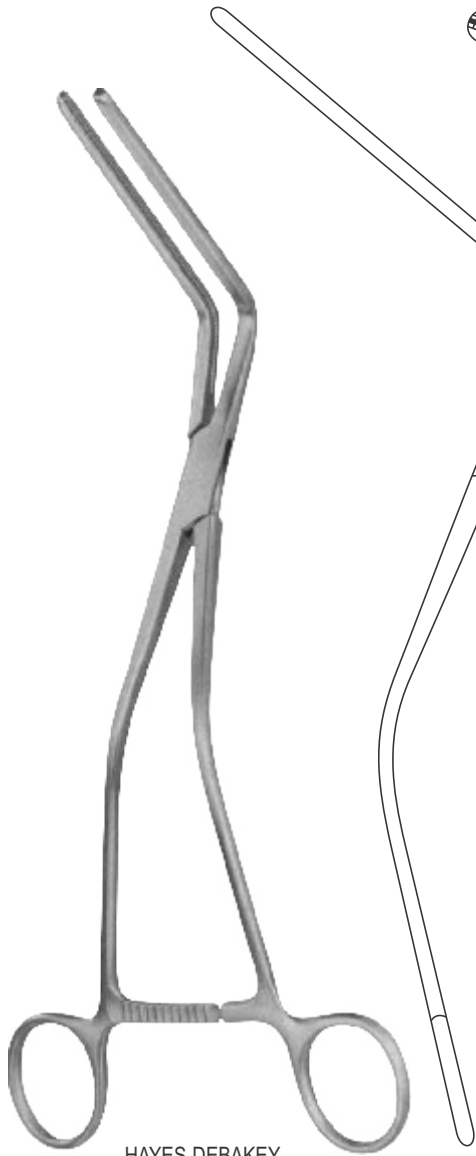

HAYES-DEBAKEY
CM12-119 - CM12-120

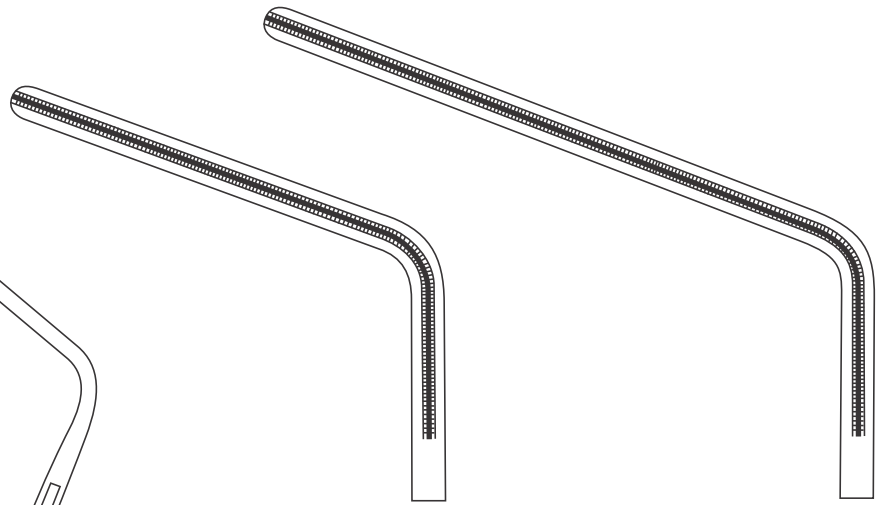

CM12-119
260 mm
55 mm

CM12-120
280 mm
85 mm



FEHLAND-DEBAKEY
CM12-121
240 mm

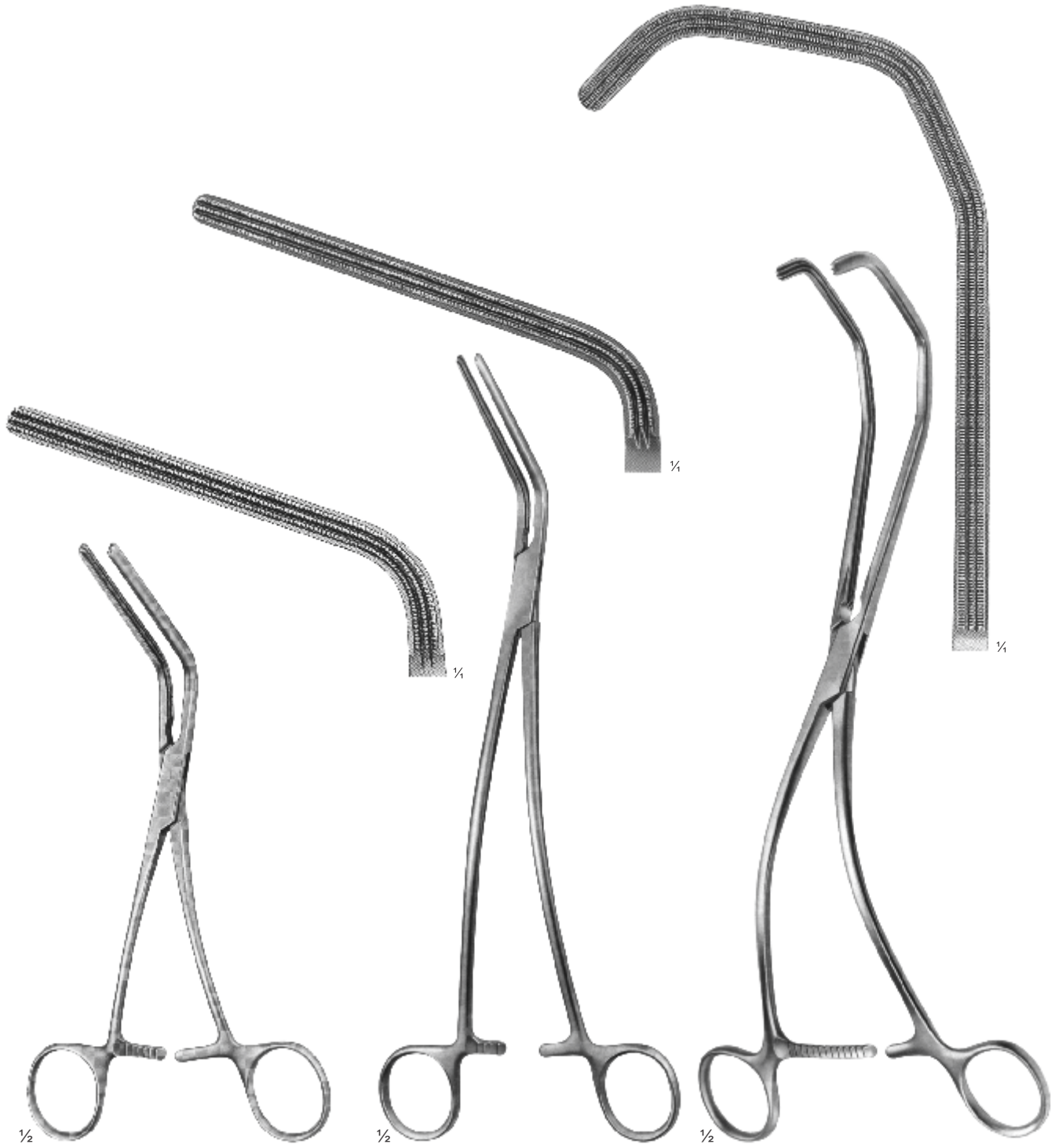

1/2

CM12-122
MORRIS
175 mm

1/2

CM12-123
DE BAKEY
(MORRIS modif.)
240 mm

1/2

CM12-124
KERSTING
270 mm

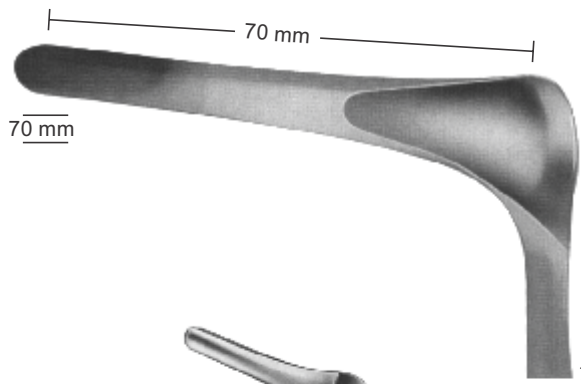

CM12-125
KILLIAN
for children
145 mm



CM12-126
SIMS
160 mm



CM12-127
SIMS
160 mm



CZERNY
CM12-128
220 mm



ROSCHKE
CM12-129
with fibre optic



SMITH-BUIE
CM12-130
150 mm



70 x 22 mm

BARR
CM12-131
170 mm

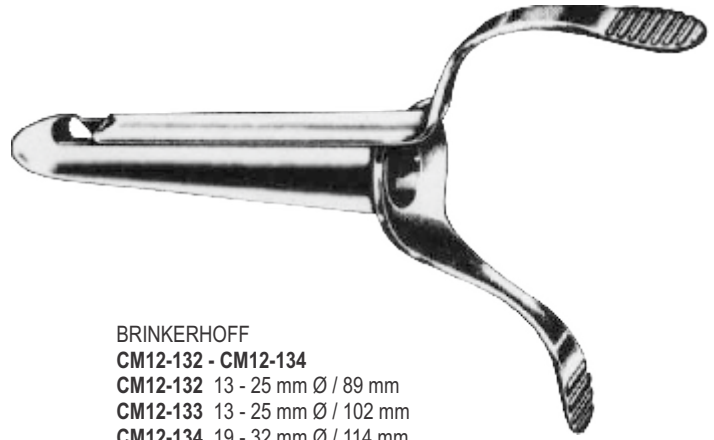

BRINKERHOFF
CM12-132 - CM12-134
CM12-132 13 - 25 mm Ø / 89 mm
CM12-133 13 - 25 mm Ø / 102 mm
CM12-134 19 - 32 mm Ø / 114 mm



MCGIVNEY
CM12-135
190 mm

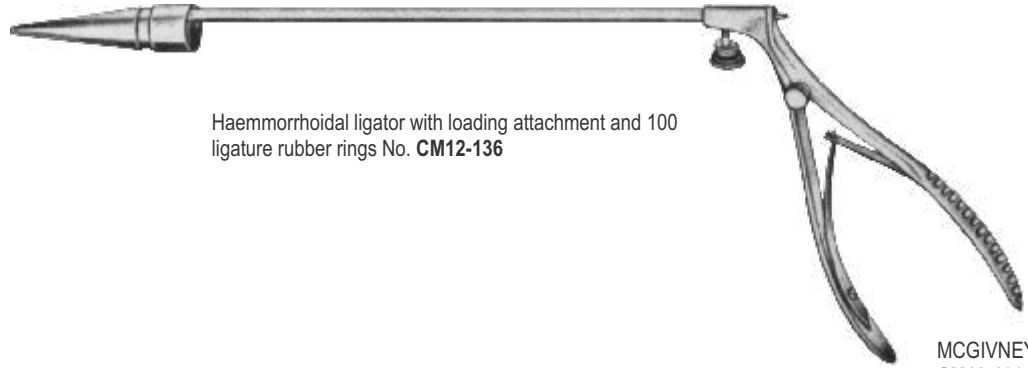

Haemorrhoidal ligator with loading attachment and 100 ligature rubber rings No. **CM12-136**

MCGIVNEY
CM12-136

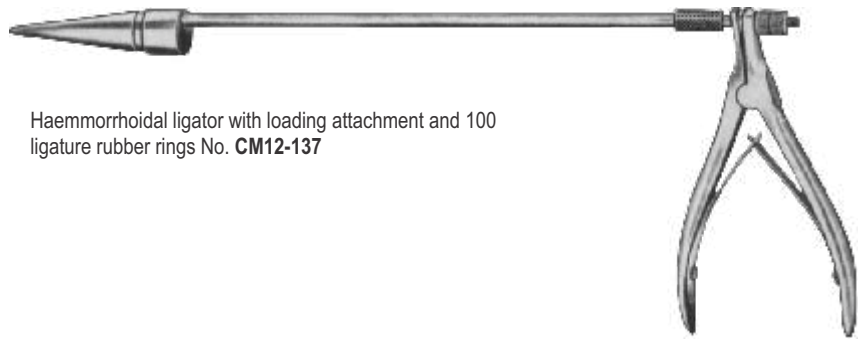

Haemorrhoidal ligator with loading attachment and 100 ligature rubber rings No. **CM12-137**

FORD-DIXON
CM12-137

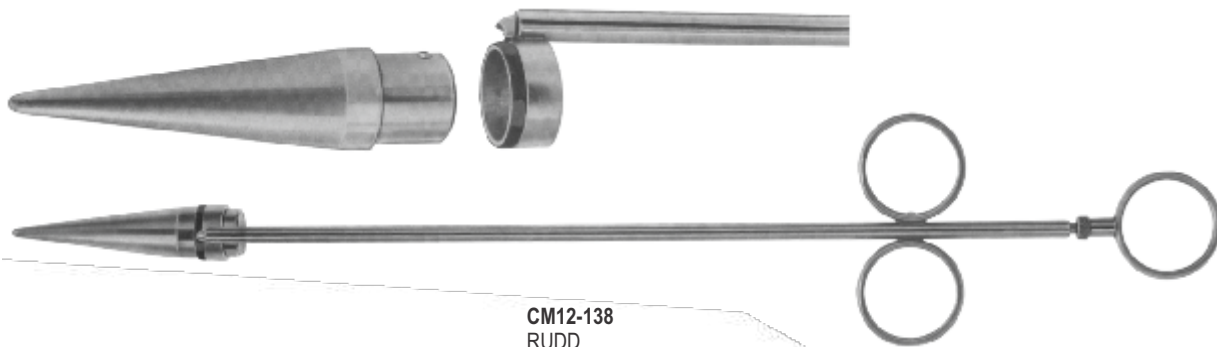

CM12-138
RUDD
Haemorrhoidal ligator
with loading
attachment and 100
ligature rubber rings
315 mm



RUDD
CM12-139
100 pieces

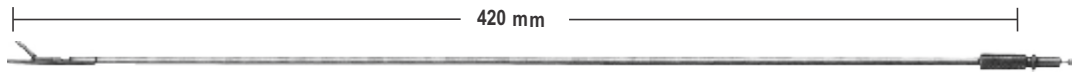

3.5 mm



1/4 CM12-140

3.5 mm



1/4 CM12-141

4 mm

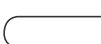

1/4 CM12-142

4 mm

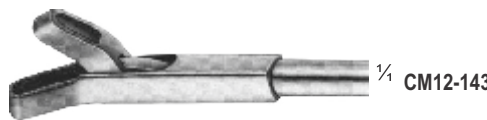

1/4 CM12-143



CM12-140 - CM12-143
Handle for 265 - 266 - 267 - 268

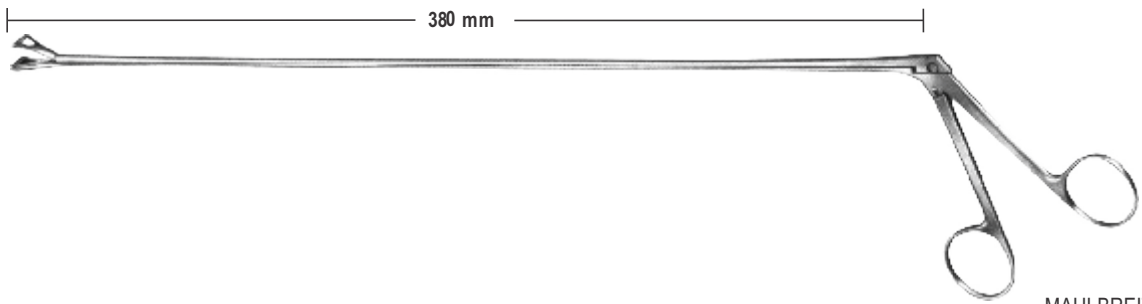

MAULBREITE
JAW WIDTH
CM12-144
380 mm
15 mm

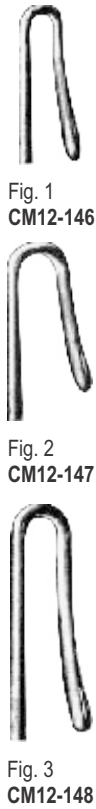

Fig. 3
CM12-148



CM12-149
12 pieces / 12 piezas



WESTON
CM12-150
300 mm



NORWOOD
CM12-151
300 mm



BUIE
CM12-152
300 mm



CM12-153
380 mm



CM12-154
380 mm



KATZENSTEIN
CM12-155
90 mm



CM12-156 - CM12-159

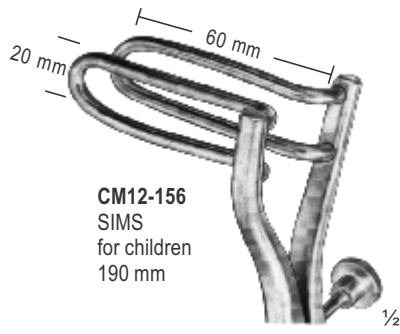

CM12-156
SIMS
for children
190 mm

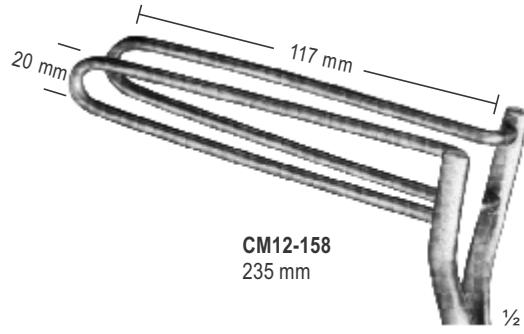

CM12-158
235 mm

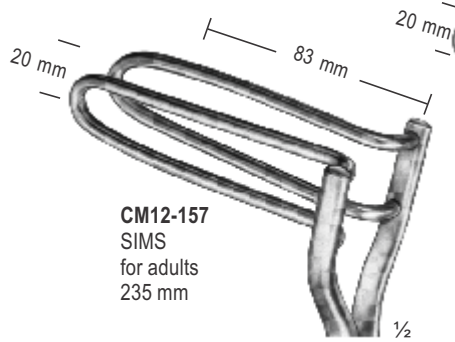

CM12-157
SIMS
for adults
235 mm

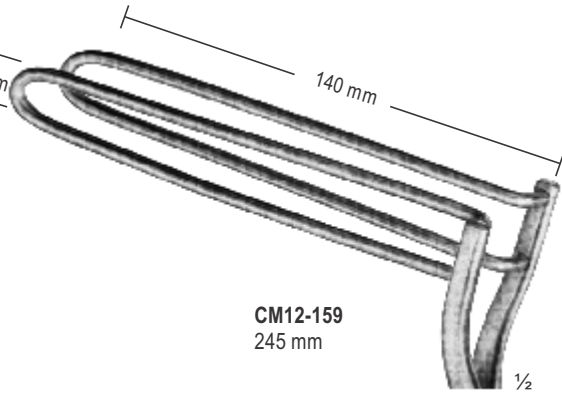

CM12-159
245 mm

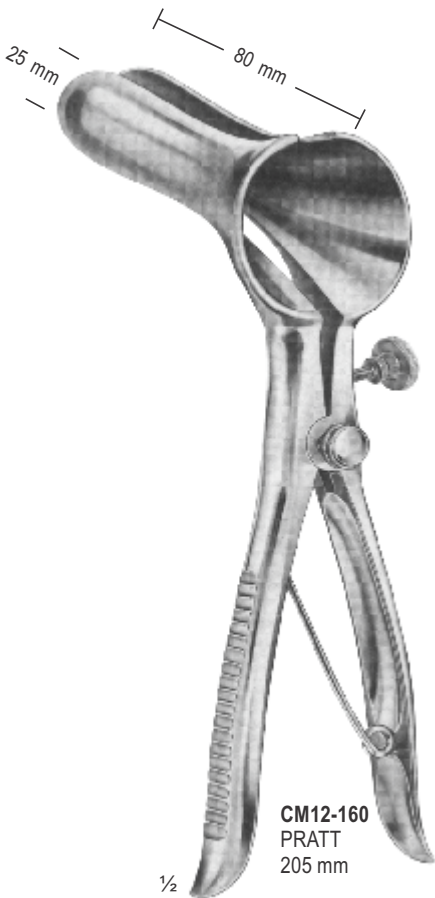

CM12-160
PRATT
205 mm

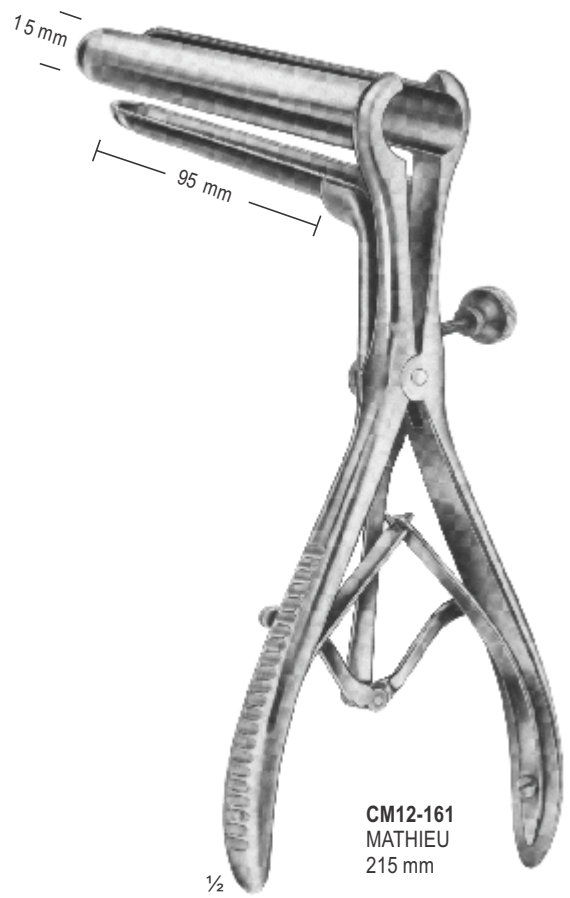

CM12-161
MATHIEU
215 mm

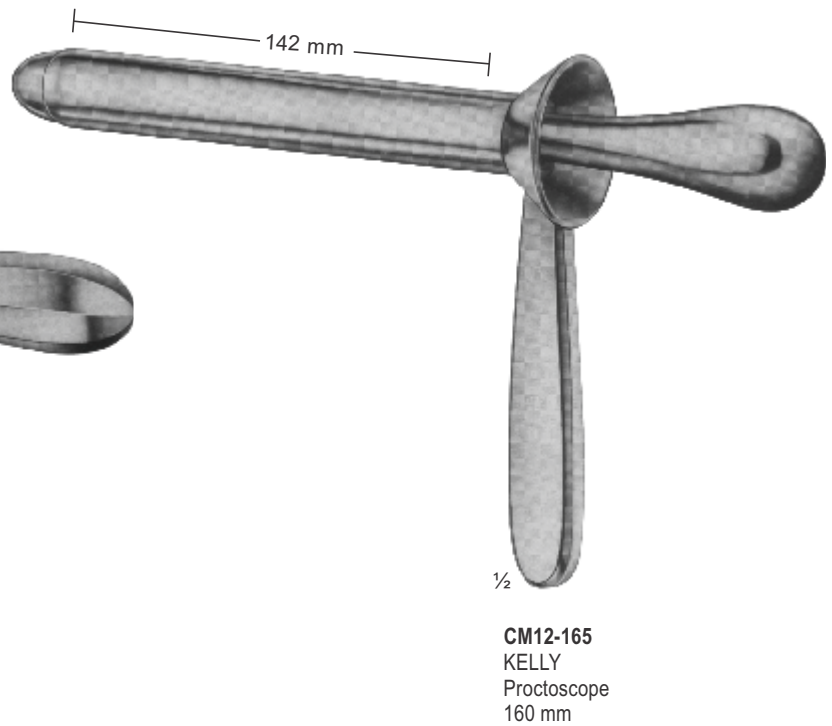
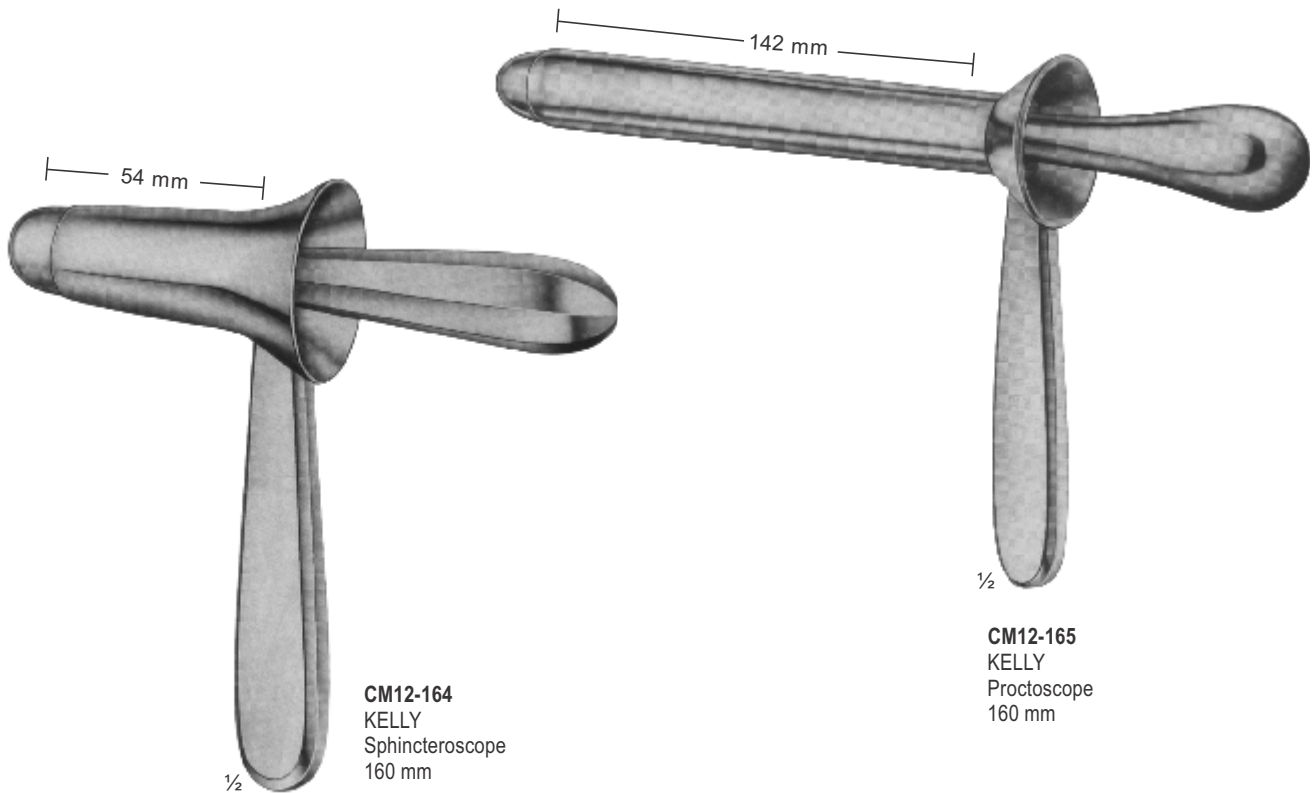
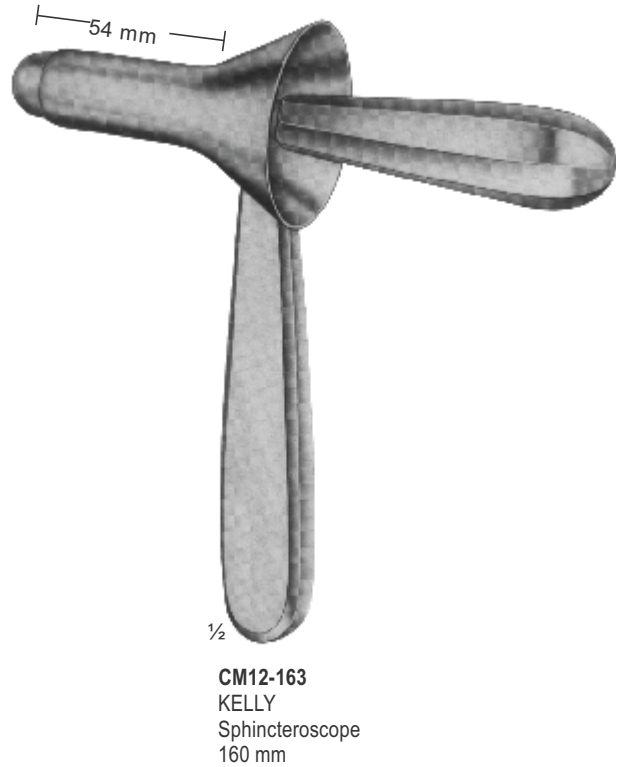

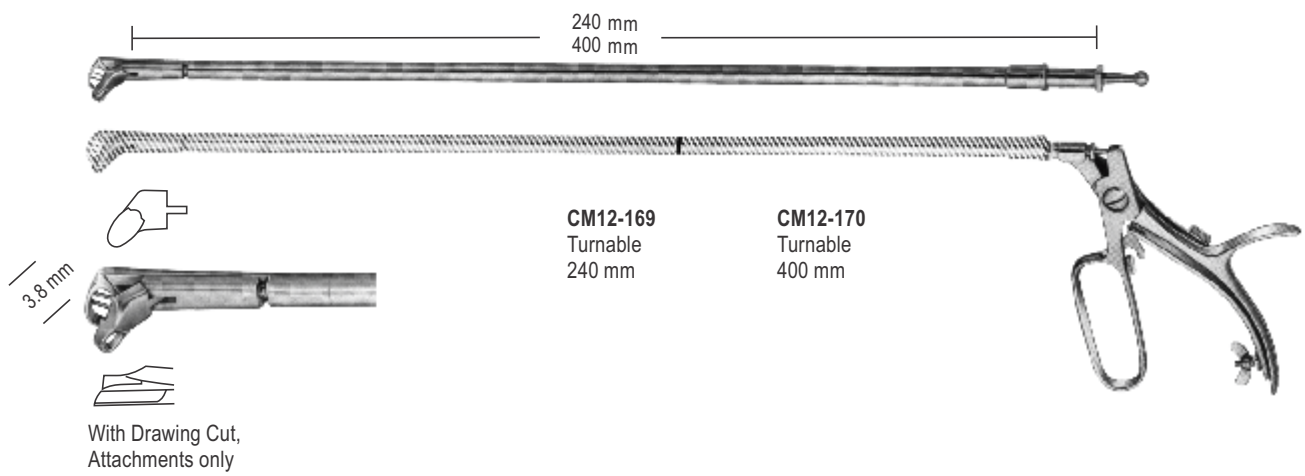
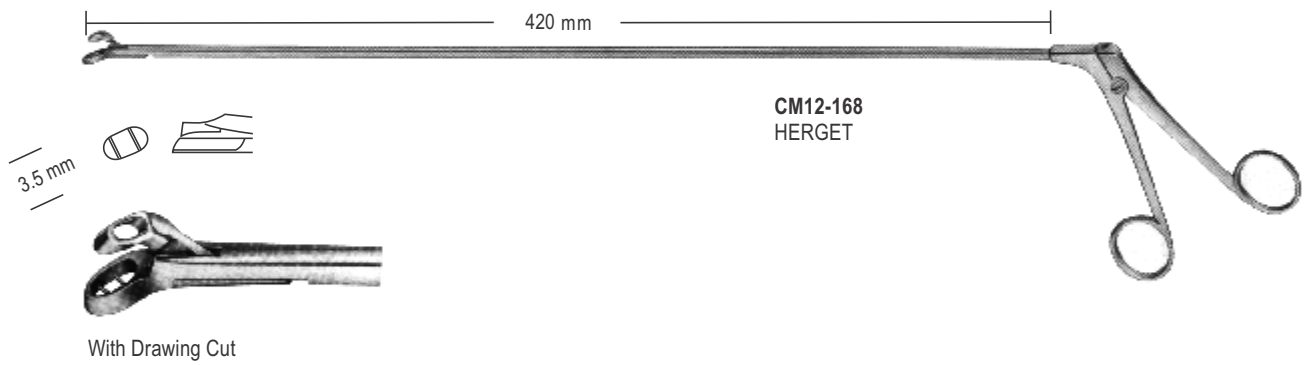
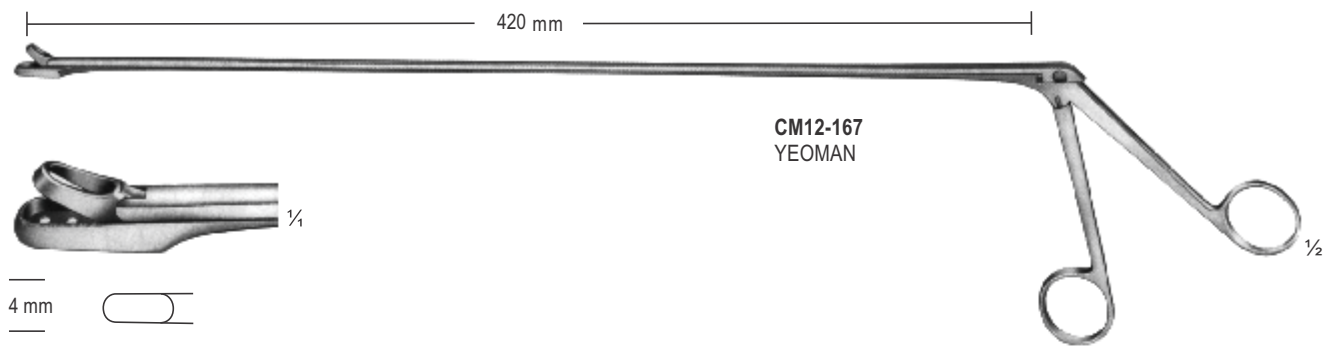
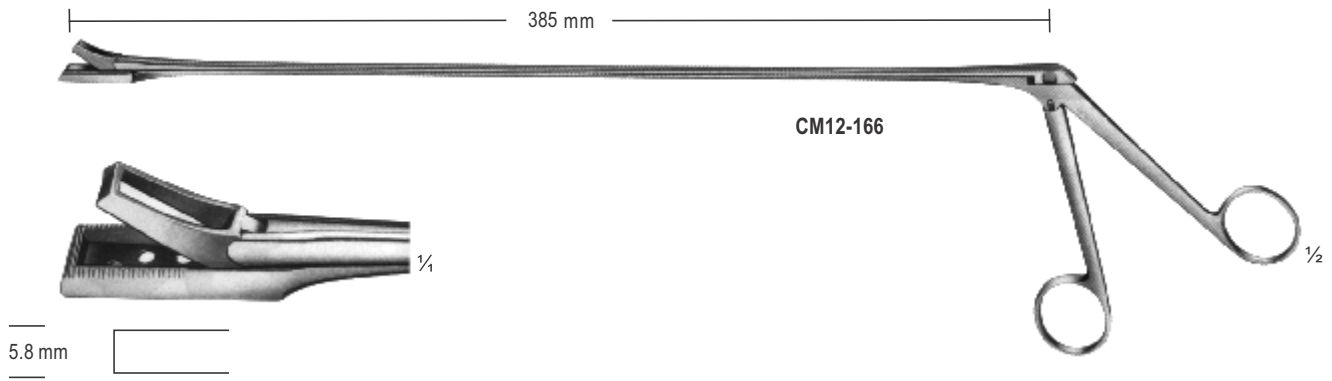



CM12-171
LOWER
180 mm



CM12-172
LAHEY (SWEET)
190 mm



CM12-173
LAHEY
220 mm

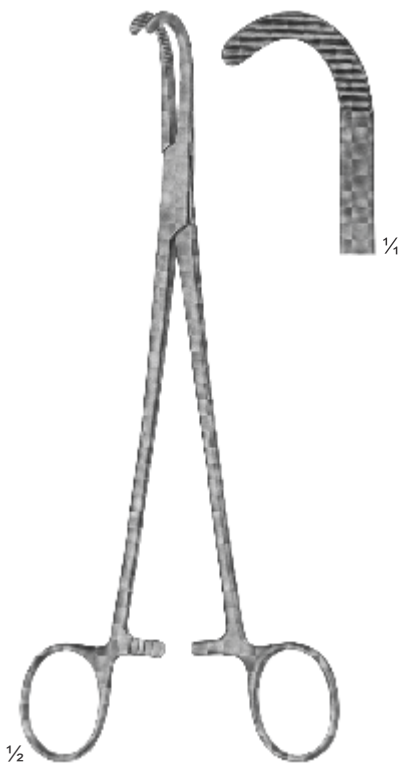

CM12-174
DESJARDINS
Gall duct-and cystic forceps
210 mm

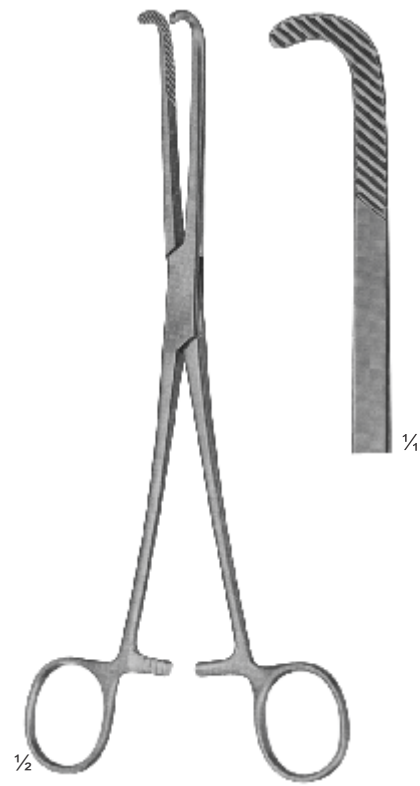

CM12-175
NISSEN
Gall duct-and cystic forceps
215 mm



CM12-176

CM12-176 - CM12-177
GRAY
180 mm

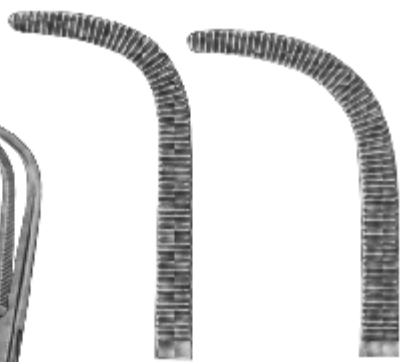

CM12-177



CM12-178 CM12-179

CM12-178 - CM12-179
MIXER
Gall duct-and cystic forceps
230 mm

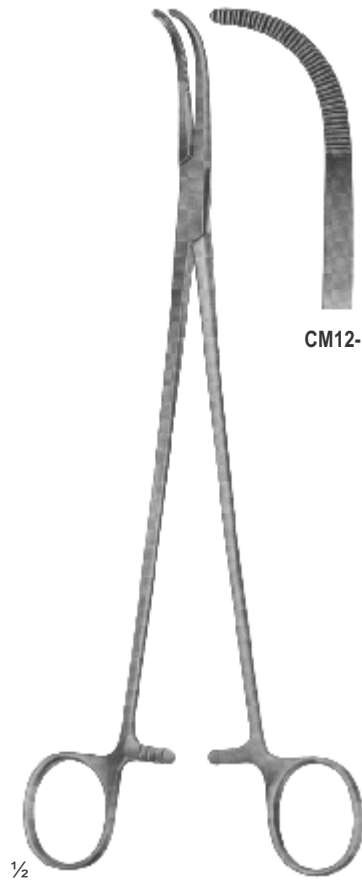
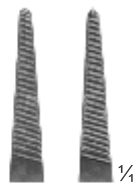

CM12-180

CM12-180
FOERSTER-BALLENGER
240 mm

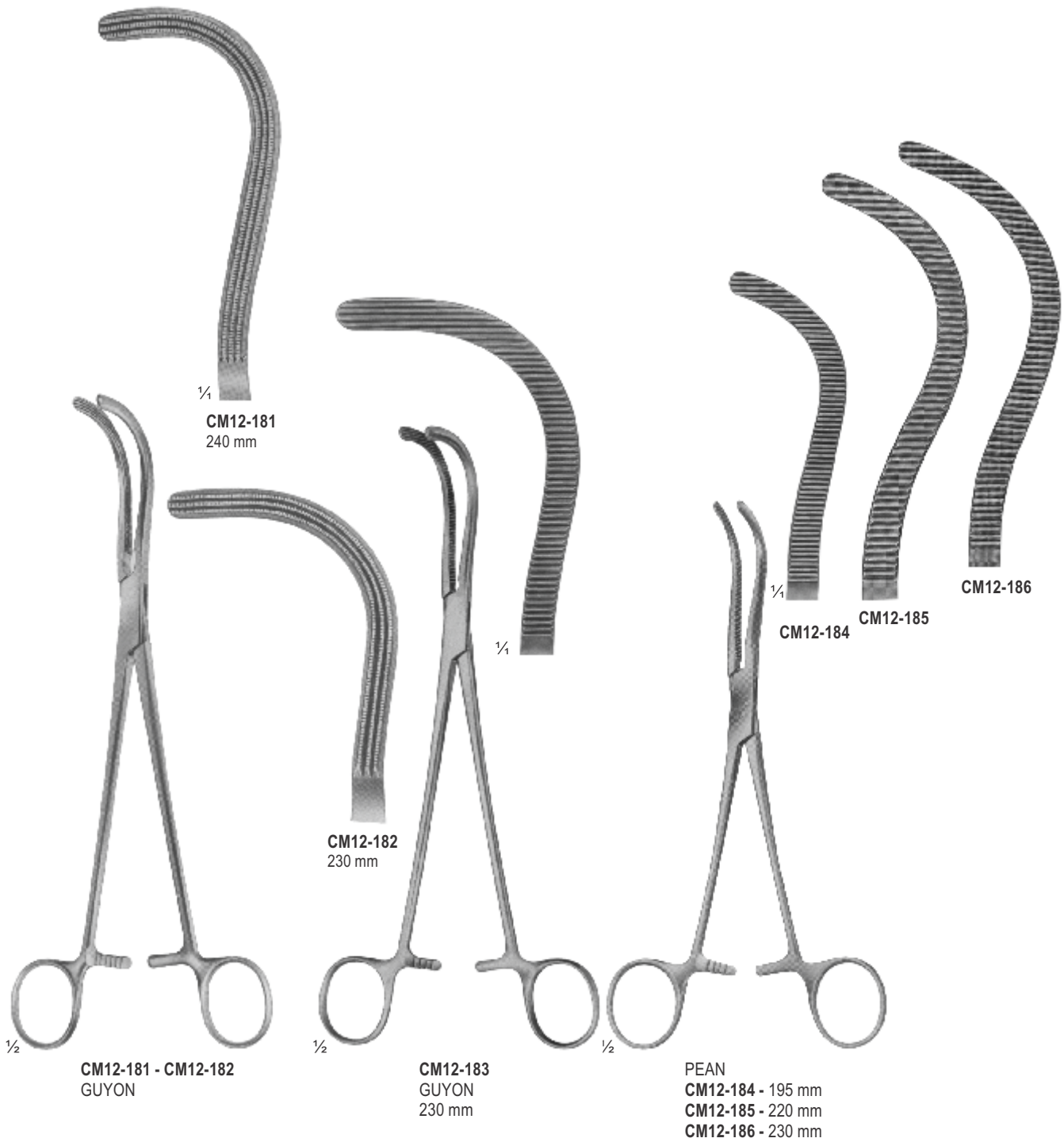

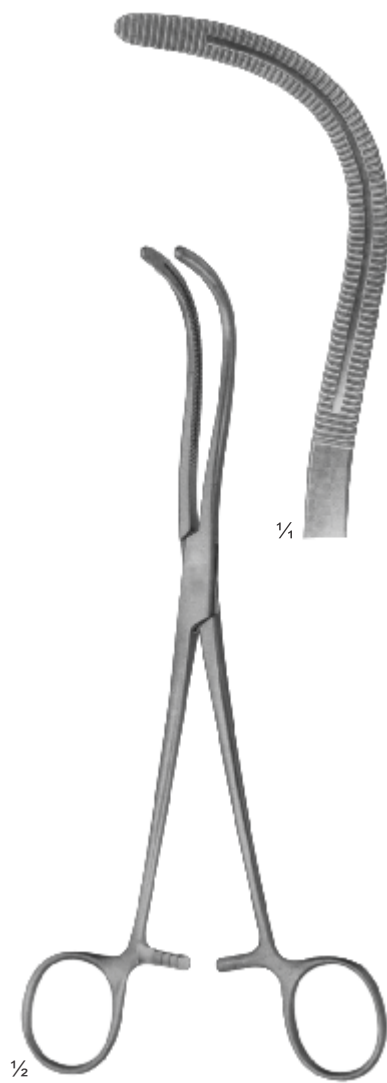

CM12-187
STILLE
220 mm

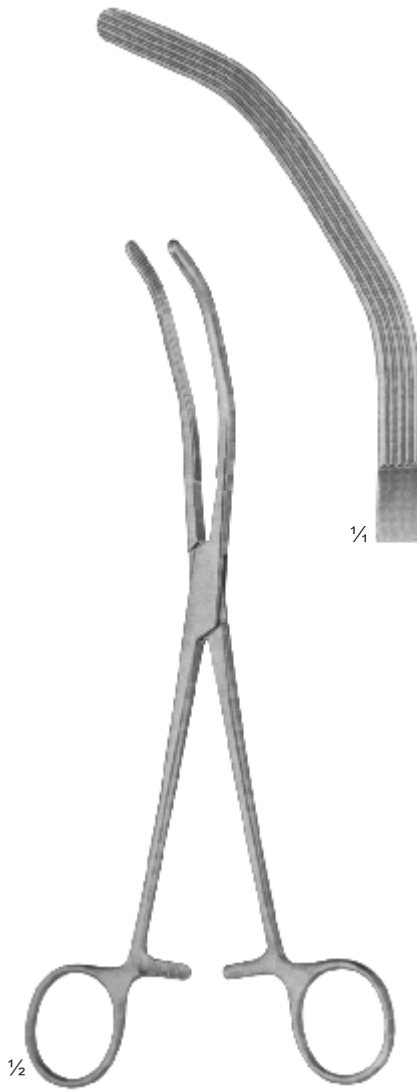

CM12-188
HERRICK
225 mm

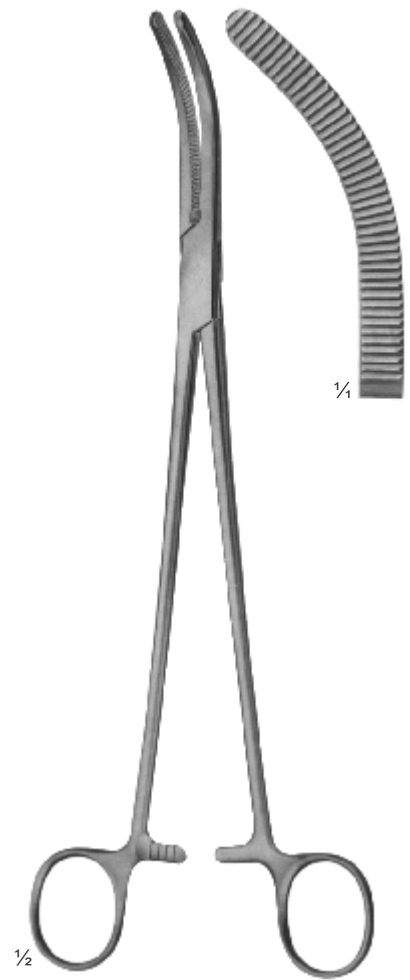

CM12-189
WERTHEIM
225 mm



CARE MEDICAL[®]
S U P P L I E S

Your health _ Our Priority

Section

13

Page 248-258

Kidney Stone Forceps
Gall Stone, Capsule Forceps
Prostatic Retractors
Rectal Spreaders
Gall Duct Probes
Gall Duct Dilators And Gall Stone Scoops

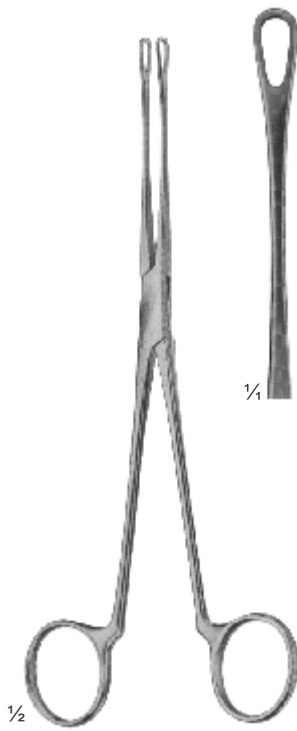

CM13-001
BLAKE
205 mm

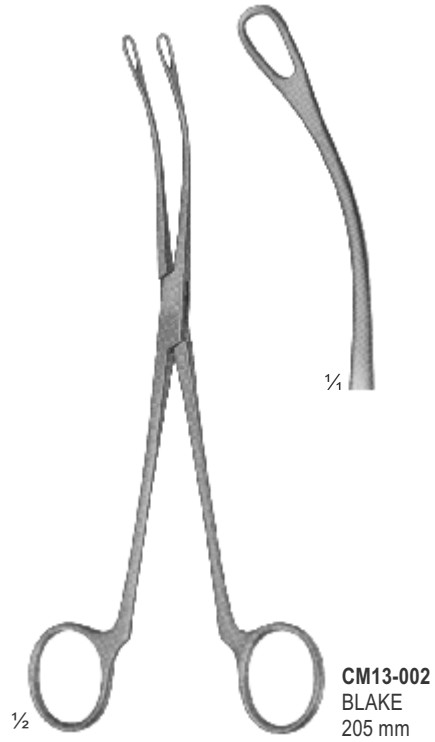

CM13-002
BLAKE
205 mm

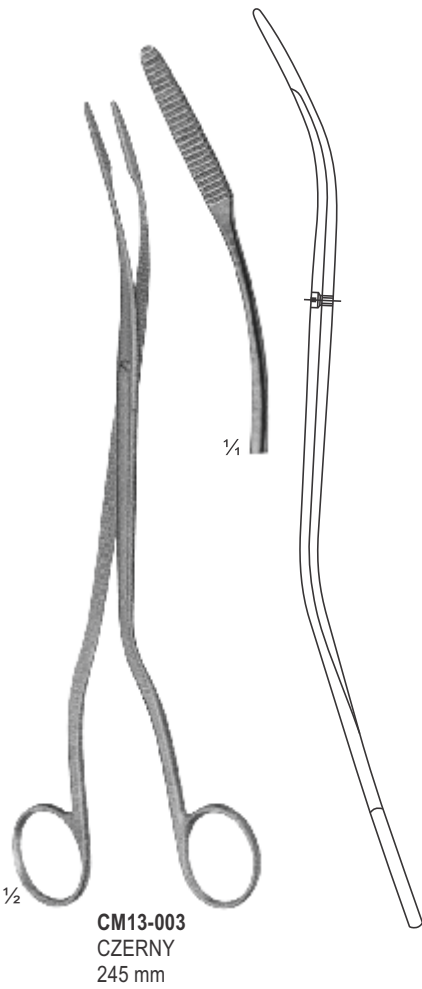

CM13-003
CZERNY
245 mm

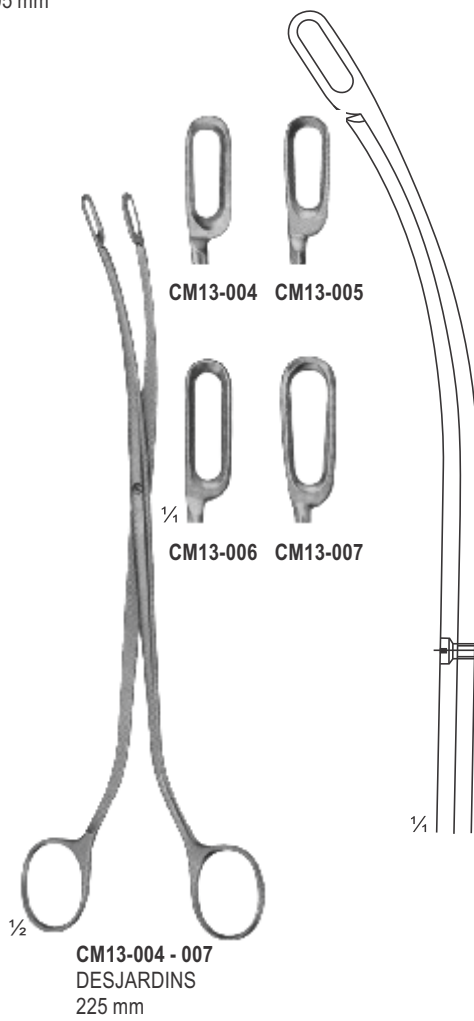

CM13-004 - 007
DESJARDINS
225 mm

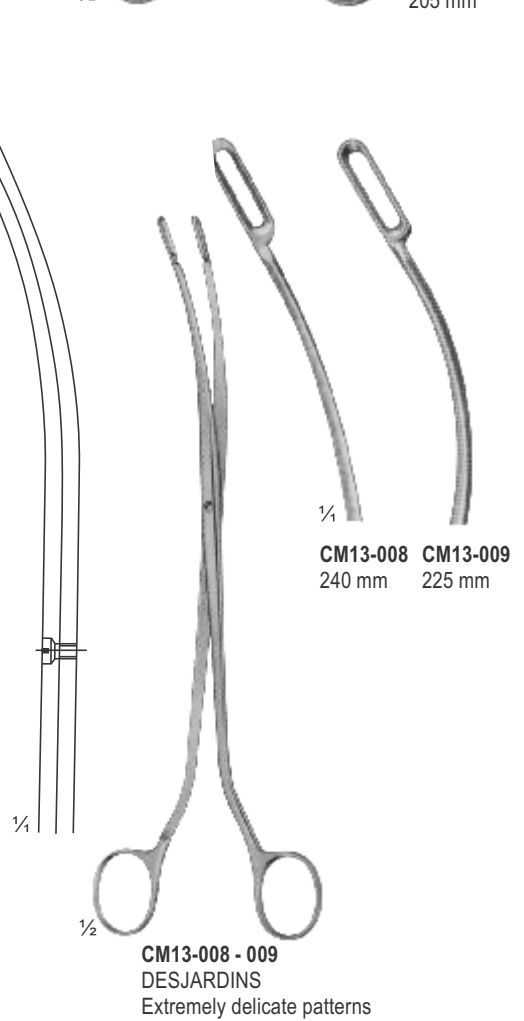

CM13-008 - 009
DESJARDINS
Extremely delicate patterns



CM13-010



CM13-014



CM13-011



CM13-015



1/2

CM13-010 - 013
RANDALL
225 mm



CM13-012



1/4
CM13-016



1/4
CM13-013



1/2

CM13-014 - 016
RANDALL
190 mm

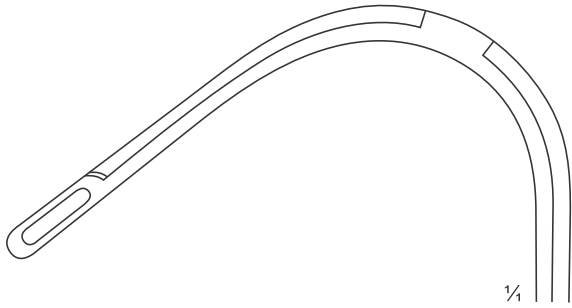

Fig. 1
CM13-017
230 mm

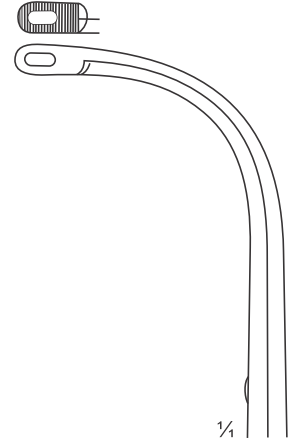

Fig. 1
CM13-019
160 mm

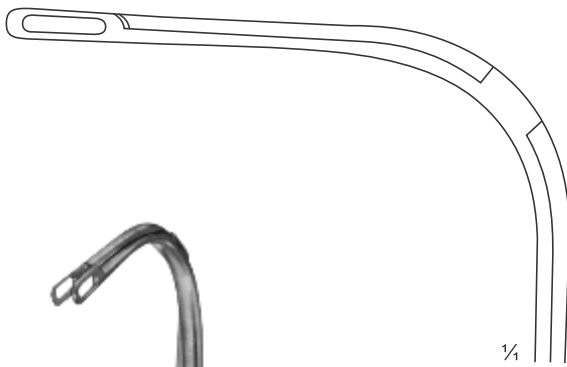

Fig. 2
CM13-018
240 mm



RANDALL
CM13-017 - 018

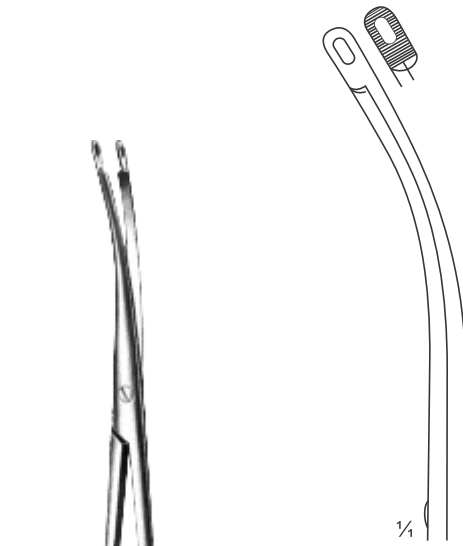
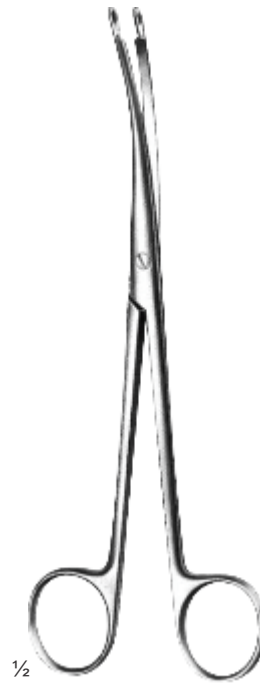

Fig. 1
CM13-020
170 mm



HEIMING
CM13-019 - 020

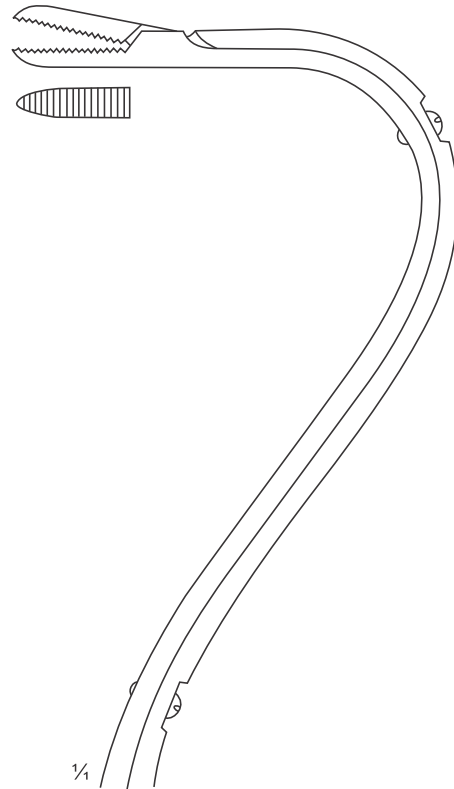

Fig. 1
CM13-021

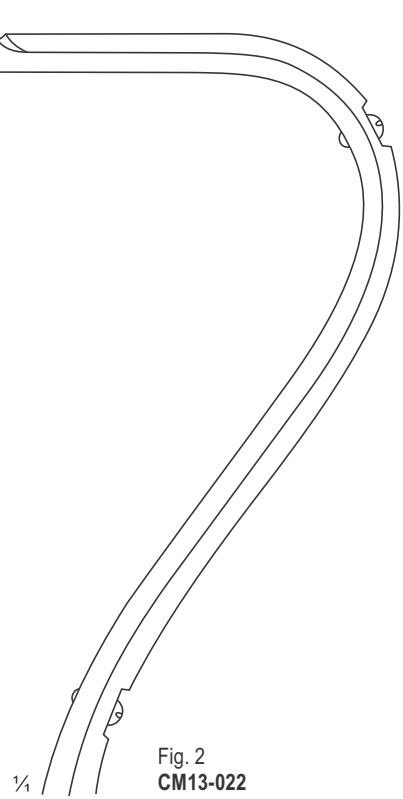
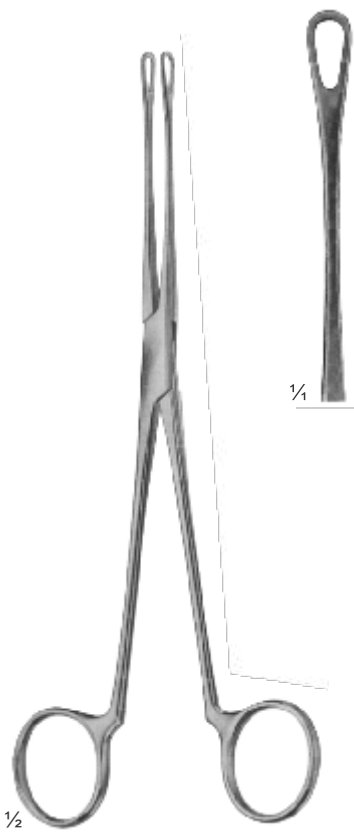
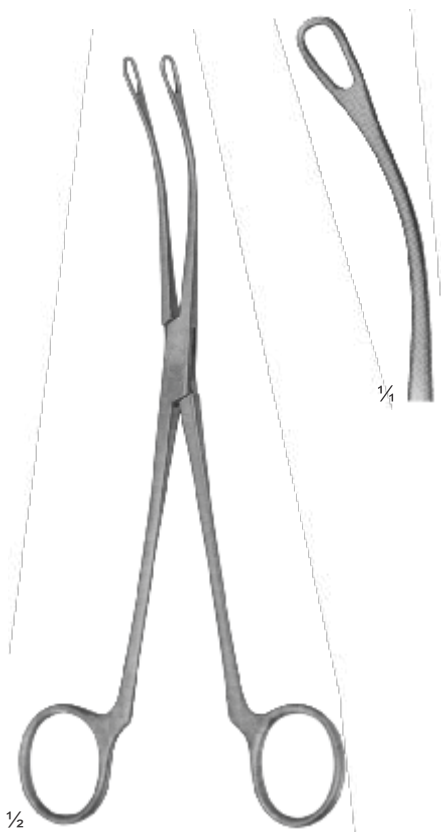

Fig. 2
CM13-022



BLAKE
CM13-023
205 mm



BLAKE
CM13-024
205 mm



MAYO-BLAKE
CM13-025
210 mm



MAYO-BLAKE
CM13-026
210 mm

ATRAUMA

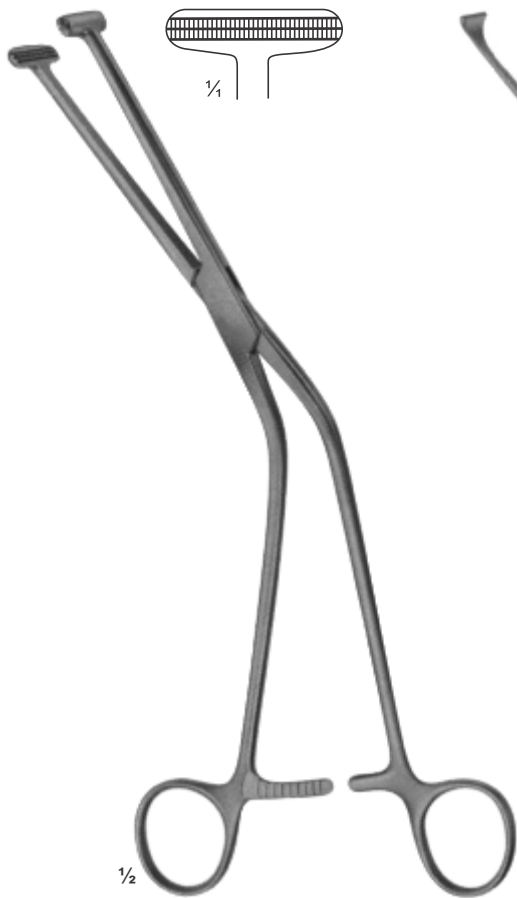

MILLIN
Lobe grasping forceps
CM13-027
235 mm

ATRAUMA



MILLIN
Lobe grasping forceps
CM13-028
245 mm



MILLIN
Ligature holding forceps
CM13-029
245 mm



LEGUEU
CM13-030
270 mm



KOCHER
CM13-031
260 mm



KOCHER
CM13-032
260 mm



1/2

YOUNG
CM13-033
210 mm



1/2

YOUNG
CM13-034
220 mm



1/2

YOUNG
CM13-035
210 mm



1/2

YOUNG
CM13-036
220 mm



1/2

SPERMATIC
CM13-037
160 mm

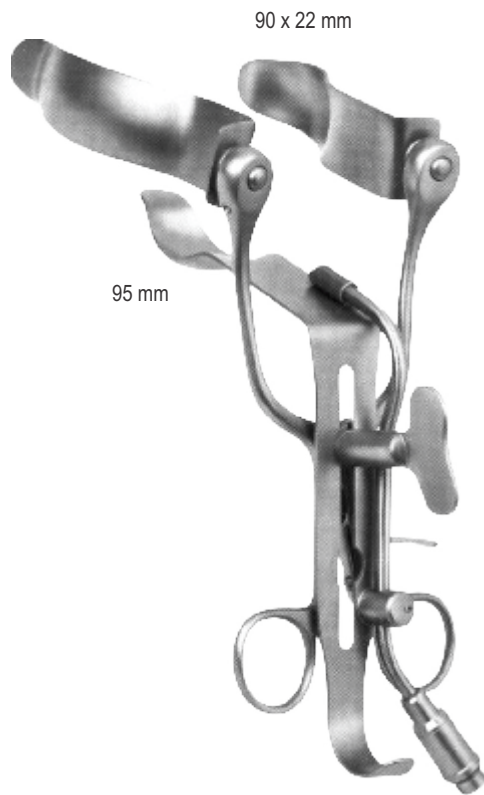

90 x 22 mm

95 mm

ALAN-PARKS
CM13-038
150 mm

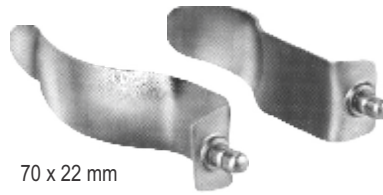

70 x 22 mm



FIBER OPTIC
CM13-039



90 x 22 mm

95 mm

70 x 22 mm

ALAN-PARKS
CM13-040
150 mm

∅ 3.5 mm



1/2

CM13-041
HAJEK
Irrigating cannula,
silver
165 mm

∅ 5 mm



1/2

CM13-042
MOYNIHAN
Gall duct probes,
malleable
365 mm

∅ 5 mm



1/2

CM13-043
MAYO
Gall duct probes,
malleable
330 mm

∅ 3.5 mm

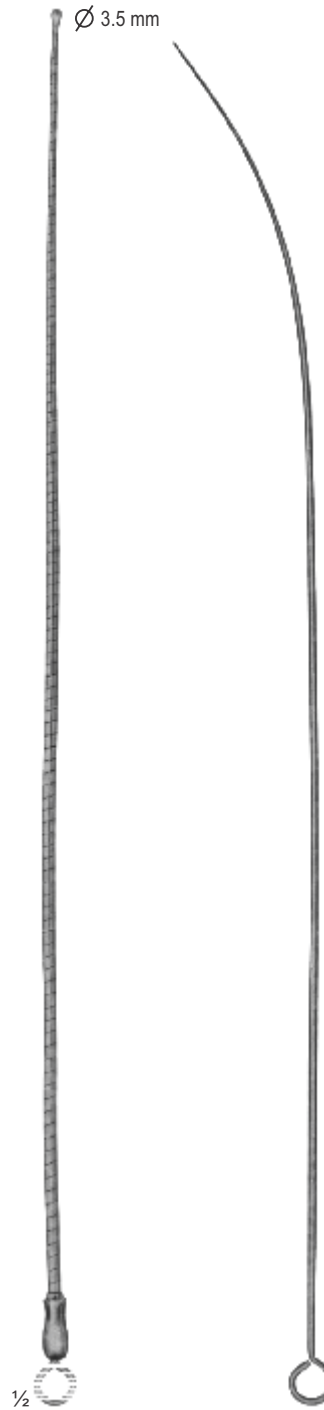

1/2

CM13-044
OCHSNER
Gall duct probes, flexible
400 mm

∅ 3.8 mm



1/4

CM13-045



1/4

CM13-046



1/4

CM13-047

1/2

CM13-045 - 047
DESJARDINS
Gall duct probes,
flexible
285 mm

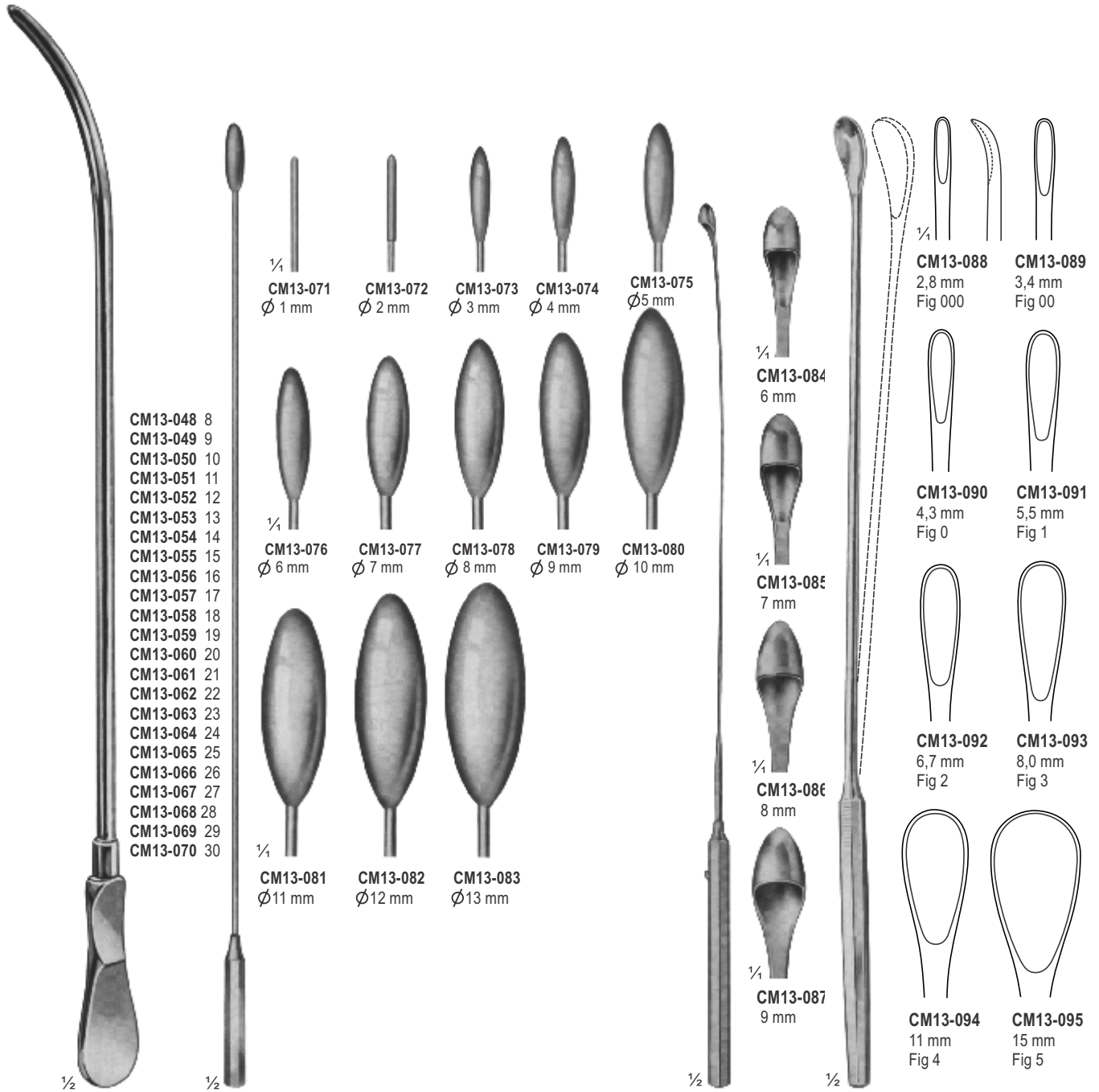

- CM13-048 8
- CM13-049 9
- CM13-050 10
- CM13-051 11
- CM13-052 12
- CM13-053 13
- CM13-054 14
- CM13-055 15
- CM13-056 16
- CM13-057 17
- CM13-058 18
- CM13-059 19
- CM13-060 20
- CM13-061 21
- CM13-062 22
- CM13-063 23
- CM13-064 24
- CM13-065 25
- CM13-066 26
- CM13-067 27
- CM13-068 28
- CM13-069 29
- CM13-070 30

CM13-048 - 070
DITTEL
Metall bougies and
dilating sounds, stiff
345 mm

CM13-071 - 083
BAKES
Common bile duct
dilators, malleable
315 mm, 320 mm

CM13-084 - 087
DESJARDINS
Probes and catch
with flexible schaft
300 mm

CM13-088 - 095
LUER-KORTE modif
with malleable shaft
310 mm



CARE MEDICAL[®]
SUPPLIES

Your health _ Our Priority

Section

14

Page 259

Kidney Stone Forceps
Gall Stone, Capsule Forceps
Prostatic Retractors
Rectal Spreaders
Gall Duct Probes
Gall Duct Dilators And Gall Stone Scoops

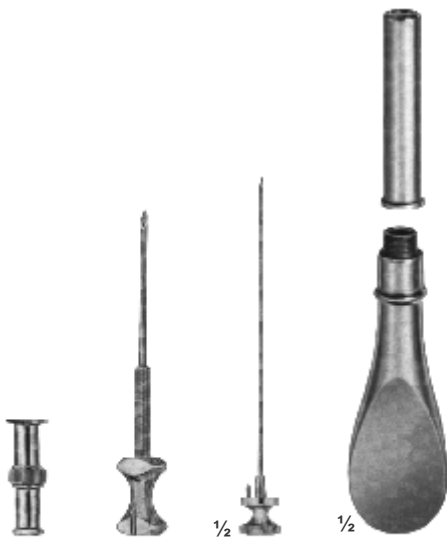

CM14-001
KLIMA ROSEGGER
35 X 1,8 mm
Sternal puncture needle

CM14-002
Universal trocar
with 4 tips

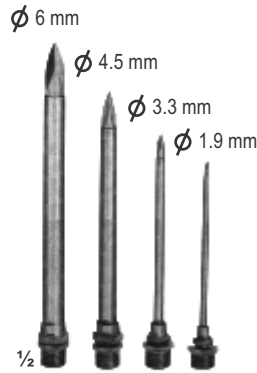

CM14-003 - 007
Inside dime. Outside dime
CM14-003 2,2 mm 3,0 mm
CM14-004 3,0 mm 4,0 mm
CM14-005 4,0 mm 5,0 mm
CM14-006 5,0 mm 6,0 mm
CM14-007 5,5 mm 6,5 mm
for hydrocele and abdominal puncture



CM14-008 - 011
Inside dime. Outside dime
CM14-008 2,2 mm 3,0 mm
CM14-009 3,0 mm 4,0 mm
CM14-010 4,0 mm 5,0 mm
CM14-011 5,0 mm 6,0 mm
for abdominal puncture,
with stop-cock and lateral drain

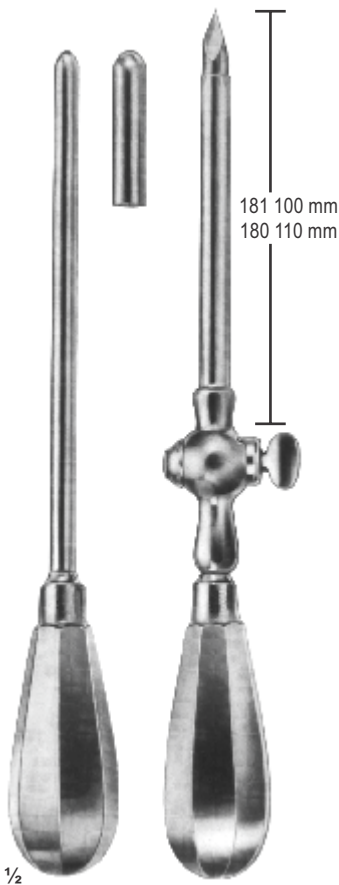

CM14-012 - 013
Inside dime. Outside dime
CM14-012 6,5 mm 8 mm
CM14-013 9 mm 10 mm
Empyema trocar

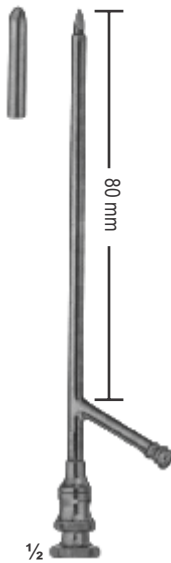

CM14-014 - 017
Inside dime. Outside dime
CM14-014 3 mm 4 mm
CM14-015 3,6 mm 4,6 mm
CM14-016 4,3 mm 5,3 mm
CM14-017 5 mm 6 mm
Gall bladder trocars



CM14-018
PIERCE
Antrum trocar
4 mm



CM14-019
COAKLEY
Antrum trocar
3 mm



CARE MEDICAL[®]
S U P P L I E S

Your health _ Our Priority

Section

15

Page 260-270

Vaginal Speculas

Vaginal Speculums-for Children & Virgins Vario Retractor

Vaginal & Wound Retractor / Vaginal Specula

Vaginal Specula, Sets, Upper & Lower Blades



Collin
CM15-001
53 x 10 mm
For children



Collin
CM15-002
95/85 x 18 mm

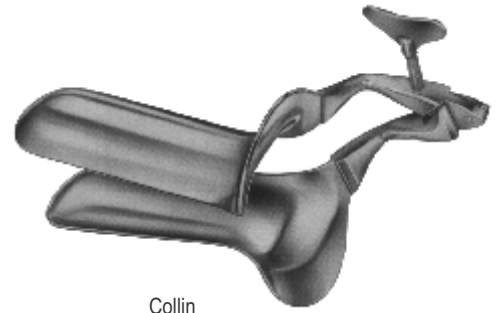

Collin
CM15-003 80 x 30 mm
CM15-004 100x 35 mm
CM15-005 110 x 40 mm



Cusco
CM15-006 90 x 22 mm Small
CM15-007 100 x 25 mm Medium
CM15-008 110 x 27 mm Large
Swiss pattern, side screw

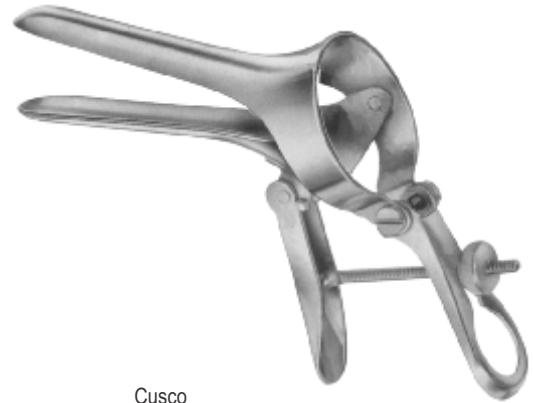

Cusco
CM15-009 75 x 32 mm Small
CM15-010 85 x 36 mm Medium
CM15-011 95 x 37 mm Large
Swiss pattern, center screw

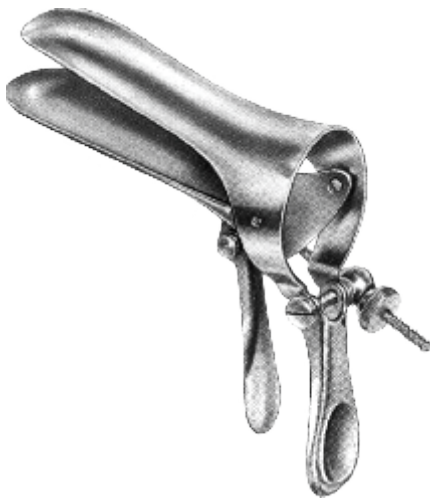

Cusco
CM15-012 95 x 30 mm Small
CM15-013 105 x 33 mm Medium
CM15-014 110 x 35 mm Large
German pattern, side screw



Cusco
CM15-015 95 x 30 mm Small
CM15-016 105 x 33 mm Medium
CM15-017 110 x 35 mm Large
German pattern, center screw



Cusco
CM15-018 Side screw
CM15-019 Center screw
 75 x 17 mm
 Virgin



Trelat
CM15-020 85 x 33 mm
CM15-021 95 x 35 mm
CM15-022 115 x 43 mm

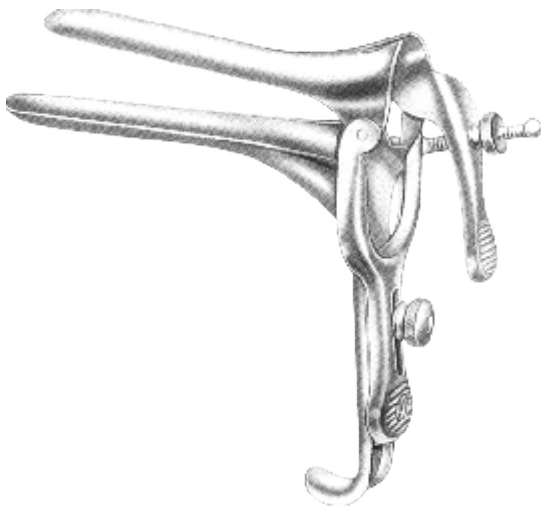

Graves
CM15-023 75 x 20 mm
CM15-024 95 x 30 mm
CM15-025 105 x 33 mm

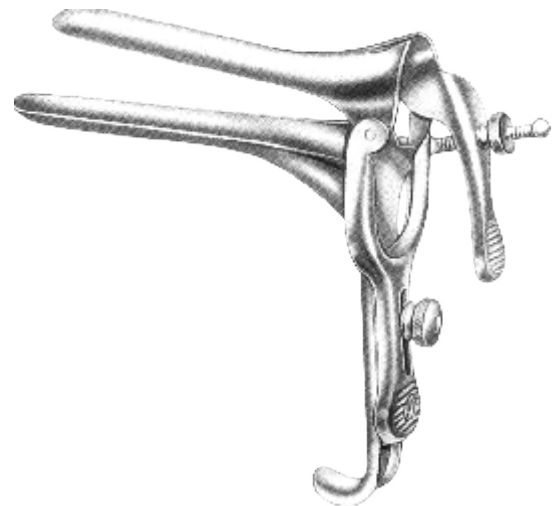

Pederson
CM15-026 75 x 13 mm
CM15-027 100 x 22 mm
CM15-028 120 x 25 mm



CM15-029 - 031
GRAVE
CM15-029 75X20 mm
CM15-030 95X30 mm
CM15-031 105X33 mm

1/2



CM15-032 - 033
CM15-032 100X22 mm
CM15-033 120X25 mm

1/2



CM15-034 - 035
BRIESKY
CM15-034 72X25 mm / 77X30 mm
CM15-035 75X30 mm / 92X38 mm
170 mm

1/2



1/2

CM15-036 - 037
BREISKY
CM15-036 100X22 mm
77 X30 mm
140 mm
CM15-037 120X25 mm
92 X38 mm
170 mm



1/2

CM15-038 - 040
SEIDL
CM15-038 80X8 mm
CM15-039 80X10 mm
CM15-040 90X14 mm
For children and infants
170 mm



1/2

CM15-041
KRISTELLER
70X15 mm, (170 mm)
For children



1/2

CM15-042 - 044
SIMS
CM15-042 70X26 mm
75 X30 mm 125 mm
CM15-043 75X30 mm
80 X85 mm 150 mm
CM15-044 80X36 mm
90 X40 mm 175 mm



CM15-050 75X10 mm
175 mm

CM15-054 70X15 mm
175 mm

CM15-051 75X23 mm
180 mm

CM15-055 70X27 mm
180 mm

CM15-052 80X25 mm
180 mm

CM15-056 75X30 mm
180 mm

CM15-053 100X32 mm
185 mm

CM15-057 90X36 mm
185 mm

CM15-045 - 049
KRISTELLER
CM15-045 110X18 mm
CM15-046 110X20 mm
CM15-047 110X27 mm
CM15-048 110X30 mm
CM15-049 110X36 mm
 220 mm

CM15-050 - 053
KRISTELLER
Upper blades

CM15-054 - 057
KRISTELLER
Lower blades

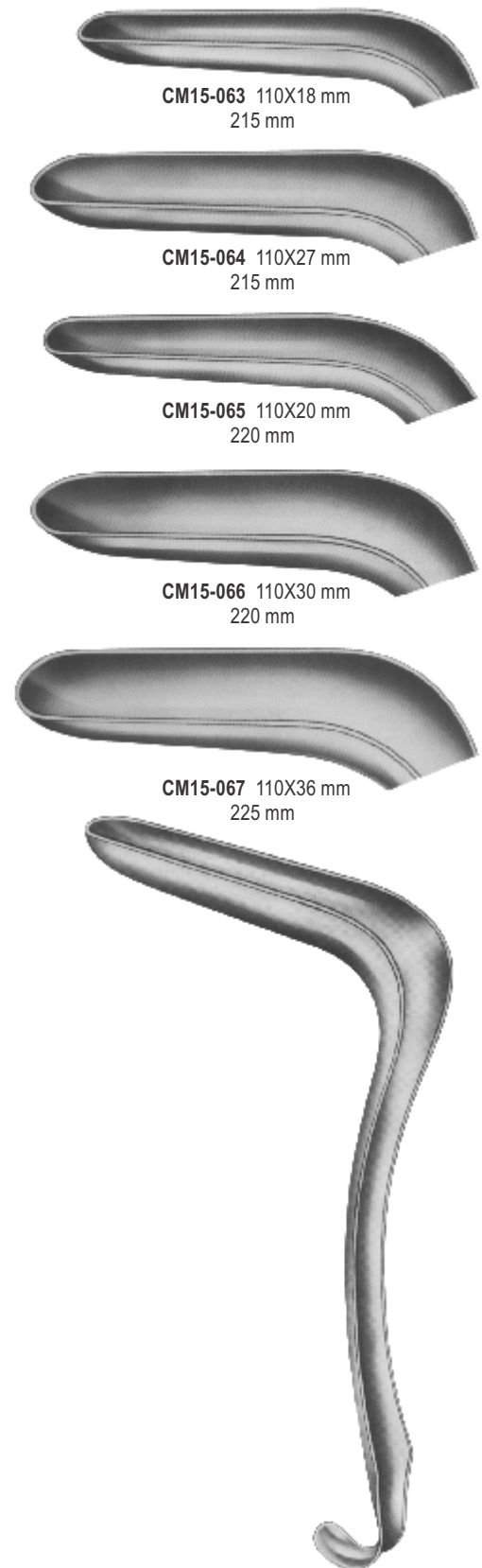

CM15-058 - 062
KRISTELLER
Upper blades

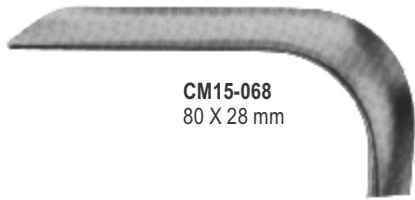

CM15-068
80 X 28 mm

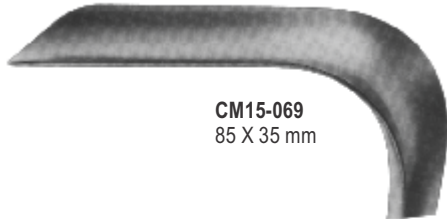

CM15-069
85 X 35 mm

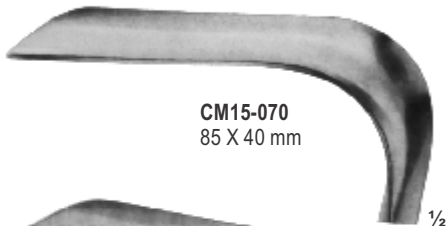

CM15-070
85 X 40 mm



Slightly Concave

1/2

CM15-068 - 070
KRISTELLER
205 mm



CM15-071
76 X 38 mm

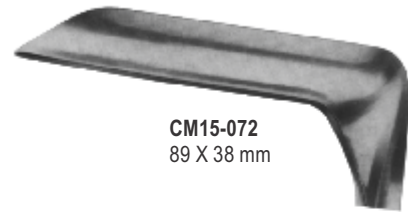

CM15-072
89 X 38 mm

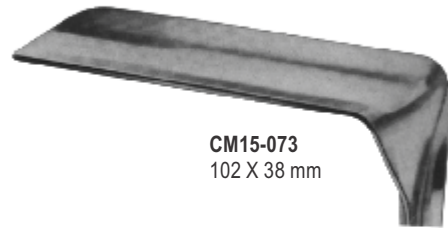

CM15-073
102 X 38 mm



Slightly Concave

1/2

CM15-071 - 073
JACKSON
175 mm



1/2

CM15-074
BRAUN
180 mm



1/2

CM15-075
BRAUN
180 mm

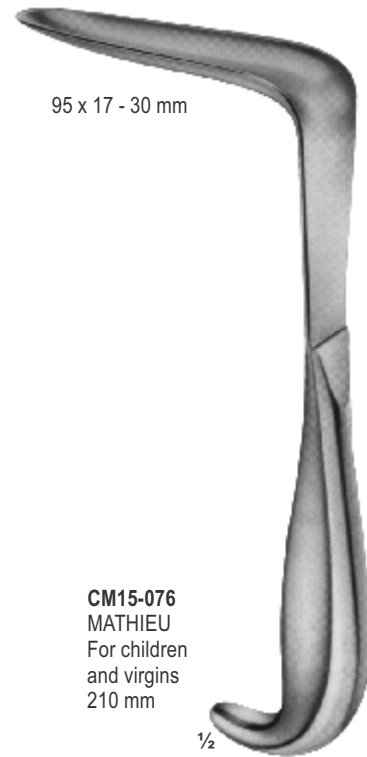

95 x 17 - 30 mm

CM15-076
MATHIEU
For children
and virgins
210 mm

1/2



95 x 17-26 mm

CM15-077
MATHIEU
for children and
virgins fitting
210 mm

1/2



CM15-078
Handle with cold light
carrier for upper blades
280 mm

1/2

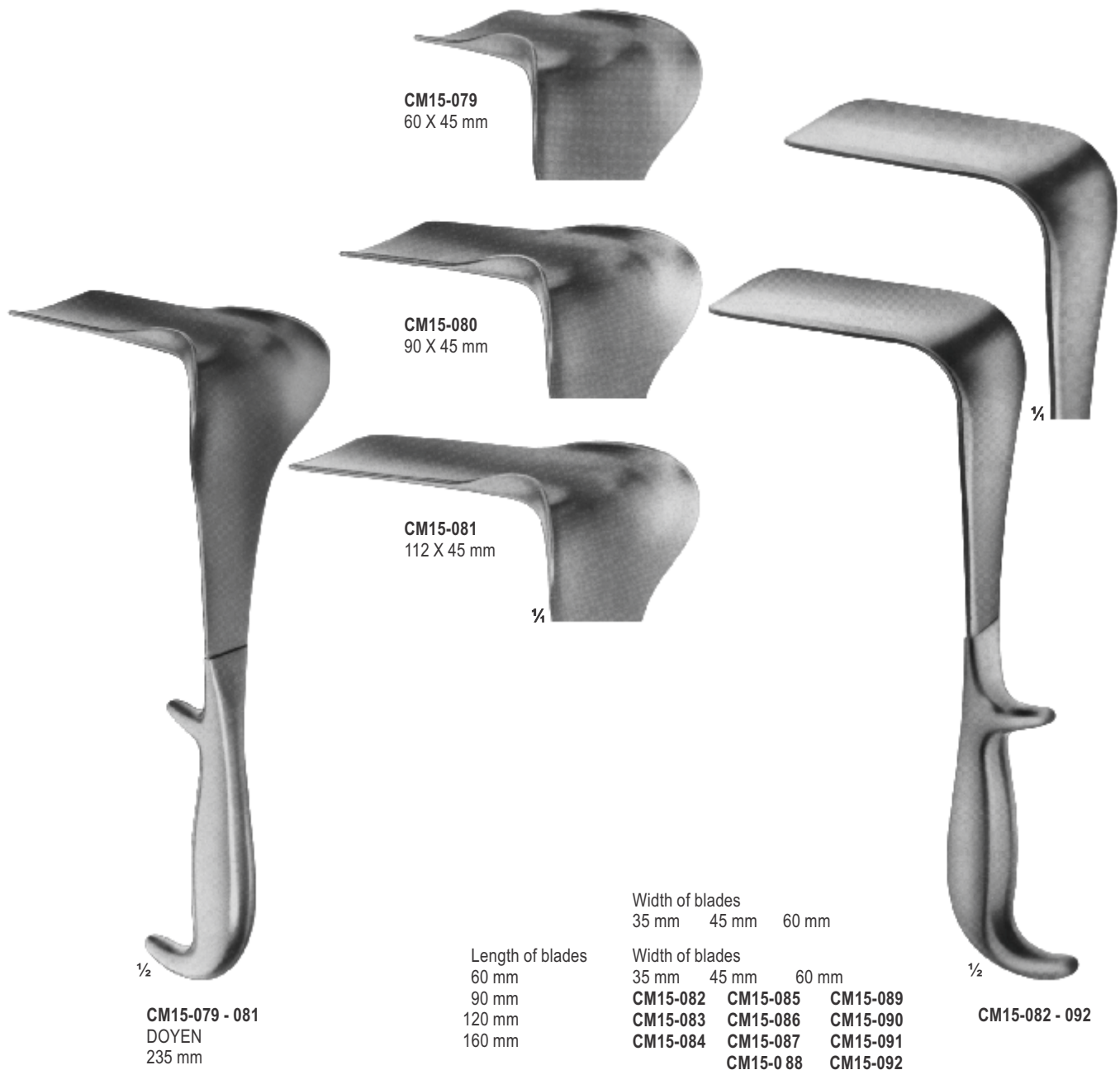



1/2

CM15-093 - 097
BREISKY
WIENER MODELL/
VIENNA PATTERN
CM15-093 100 X 20 mm
CM15-094 100 X 25 mm
CM15-095 100 X 30 mm
CM15-096 100 X 35 mm
CM15-097 100 X 40 mm
300 mm



1/2

CM15-098 - 102
BREISKY
WIENER MODELL/
VIENNA PATTERN
CM15-098 130 X 20 mm
CM15-099 130 X 25 mm
CM15-100 130 X 30 mm
CM15-101 130 X 35 mm
CM15-102 130 X 40 mm
320 mm

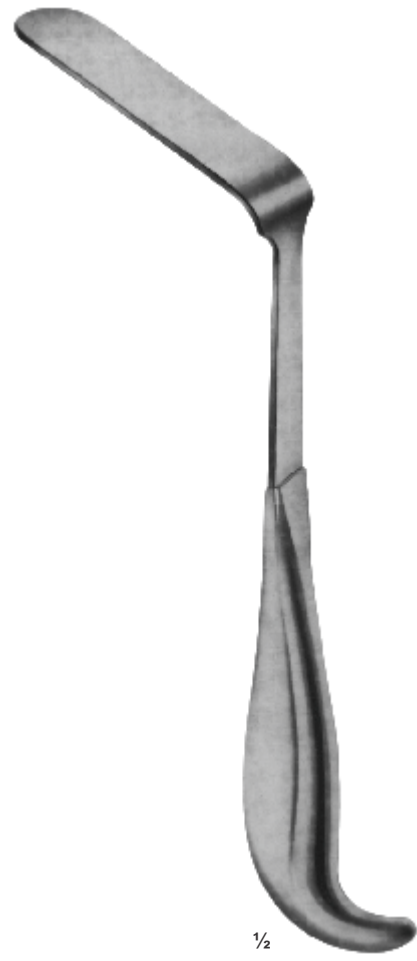

1/2

CM15-103
DOYEN
lateral speculum
80 x 30 mm
250 mm



1/2

CM15-104
SIMON
115 X 22 mm
275 mm



CM15-105
AUVARD
65 X 38 mm - 28 mm
1,530 kg
with fixed weight
230 mm

1/2

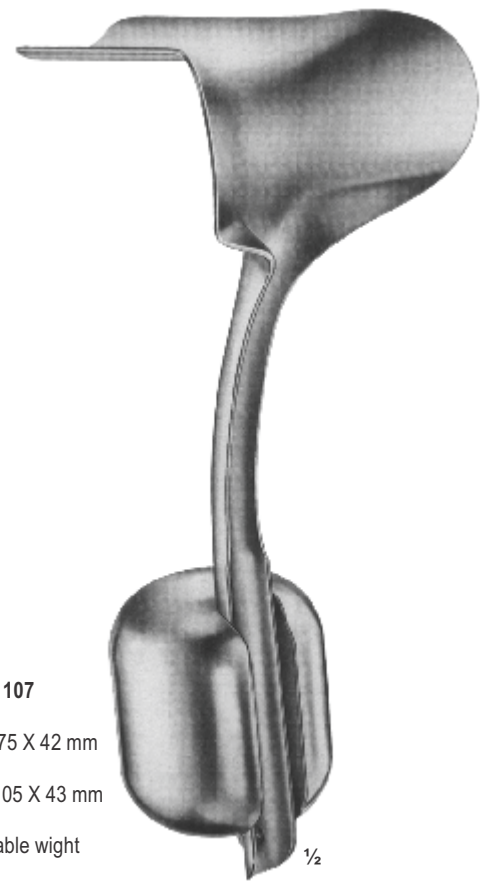

CM15-106 - 107
AUVARD
CM15-106 75 X 42 mm
(40 mm)
CM15-107 105 X 43 mm
(40 mm)
with detachable wight
230 mm

1/2



CM15-108
80 X 30



CM15-109
85 X 35

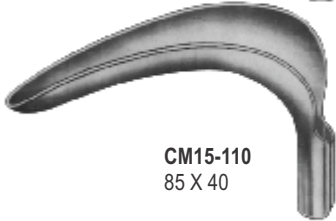

CM15-110
85 X 40



CM15-111
55 X 40 - 60 mm

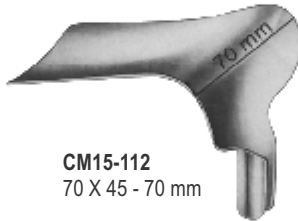

CM15-112
70 X 45 - 70 mm



CM15-113
80 X 30 mm



CM15-117
65 X 30 mm



CM15-114
85 X 33 mm



CM15-118
75 X 35 mm

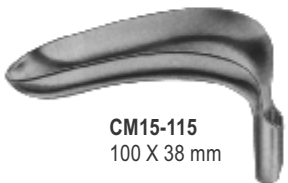

CM15-115
100 X 38 mm



CM15-119
85 X 35 mm



CM15-116
110 X 42 mm



CM15-120
95 X 35 mm



SCHERBACK
CM15-108 - 112
Set consisting of:
handle
weight
5 blades

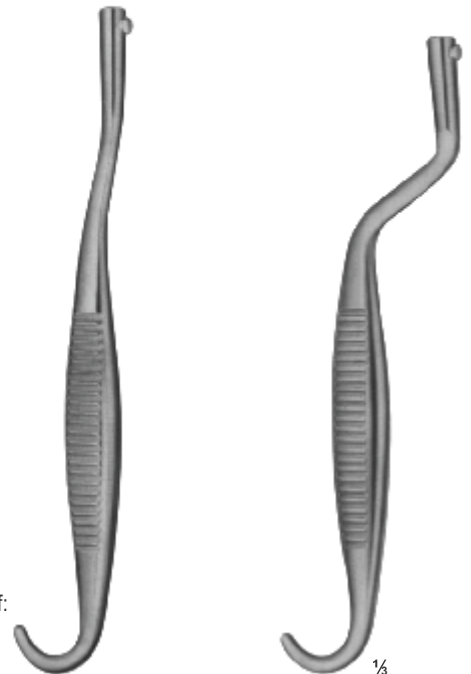

SCHERBACK
CM15-113 - 120
Set consisting of:
2 handle
8 blades



CARE MEDICAL[®]
S U P P L I E S

Your health _ Our Priority

Section

16

Page 271-293

Uterine Dilators
Endospecula For Cervix
Uterine Dressing Forceps
Uterine Tenaculum Forceps
Biopsy Forceps
Uterine Curettes-placenta And Ovum Curettes
Cervical Biopsy And Specimen Forceps

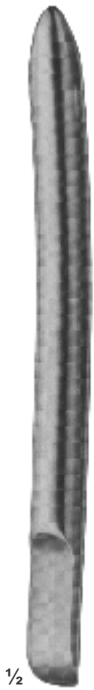

1/2

CM16-001 - CM16-043
HEGAR
with very conical point
185 mm

CM16-001	1	mm	CM16-023	23	mm
CM16-002	2	mm	CM16-024	24	mm
CM16-003	3	mm	CM16-025	25	mm
CM16-004	4	mm	CM16-026	26	mm
CM16-005	5	mm	CM16-027	1	1/2mm
CM16-006	6	mm	CM16-028	2	1/2mm
CM16-007	7	mm	CM16-029	3	1/2mm
CM16-008	8	mm	CM16-030	4	1/2mm
CM16-009	9	mm	CM16-031	5	1/2mm
CM16-010	10	mm	CM16-032	6	1/2mm
CM16-011	11	mm	CM16-033	7	1/2mm
CM16-012	12	mm	CM16-034	8	1/2mm
CM16-013	13	mm	CM16-035	9	1/2mm
CM16-014	14	mm	CM16-036	10	1/2mm
CM16-015	15	mm	CM16-037	11	1/2mm
CM16-016	16	mm	CM16-038	12	1/2mm
CM16-017	17	mm	CM16-039	13	1/2mm
CM16-018	18	mm	CM16-040	14	1/2mm
CM16-019	19	mm	CM16-041	15	1/2mm
CM16-020	20	mm	CM16-042	16	1/2mm
CM16-021	21	mm	CM16-043	17	1/2mm
CM16-022	22	mm			

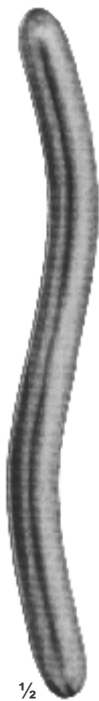

1/2

CM16-044 - CM16-052
HEGAR
205 mm

CM16-044	1+2	mm
CM16-045	3+4	mm
CM16-046	5+6	mm
CM16-047	7+8	mm
CM16-048	9+10	mm
CM16-049	11+12	mm
CM16-050	13+14	mm
CM16-051	15+16	mm
CM16-052	17+18	mm

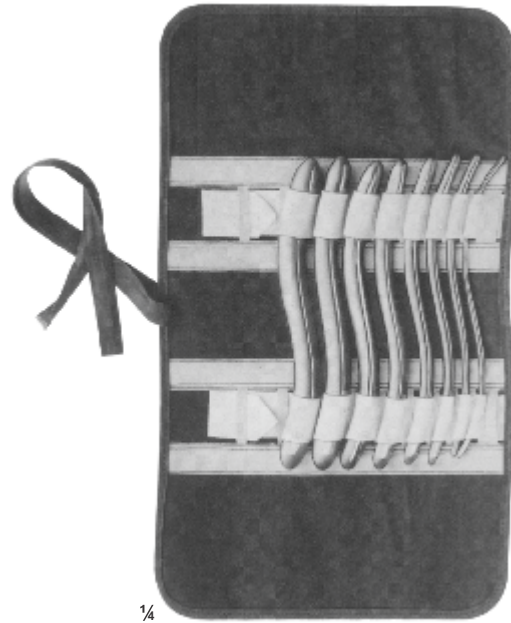

1/4

CM16-053
HEGAR
Uterine dilator set, in canvas
roll with 8 dilators.



CM16-054
HEGAR
Dilator set consisting of:
14 Dilators,
1 Rack for dilators (4 - 12 mm)
1 Rack for Dilators (13 - 17 mm)
1 Metal case only,
with hinged lid, stainless 200 X 100 X 35 mm

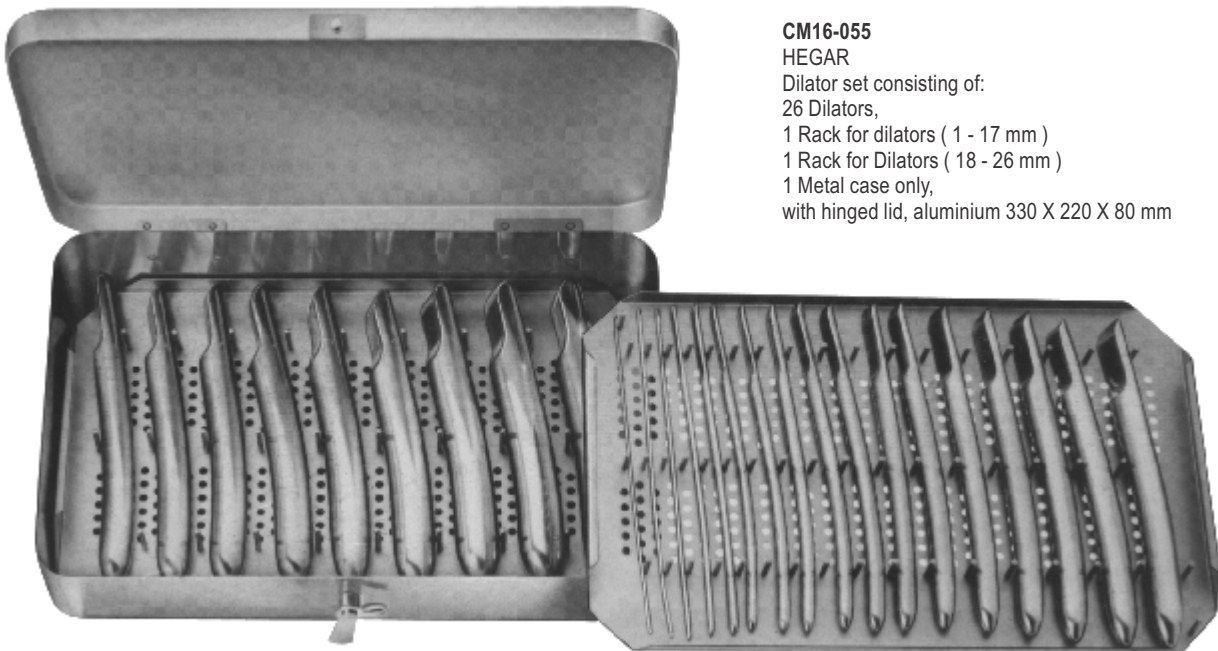

CM16-055
HEGAR
Dilator set consisting of:
26 Dilators,
1 Rack for dilators (1 - 17 mm)
1 Rack for Dilators (18 - 26 mm)
1 Metal case only,
with hinged lid, aluminium 330 X 220 X 80 mm

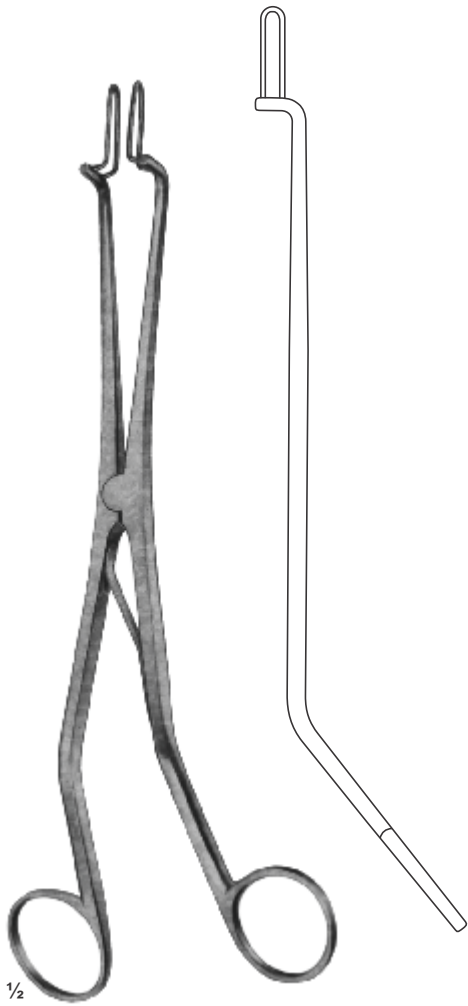

CM16-056
KOGAN
Endospecula for cervix
and urethra, without ratchet
240 mm

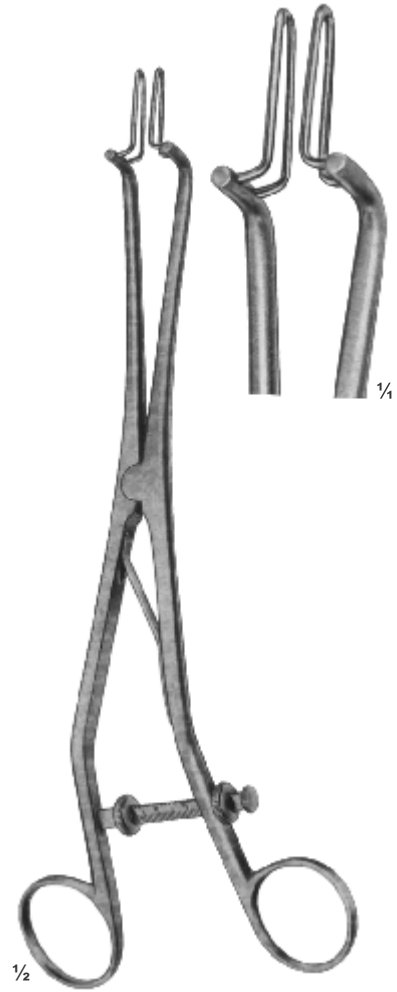

CM16-057
KOGAN
Endospecula for cervix
and urethra, with
scale-ratchet and fixing screws
240 mm

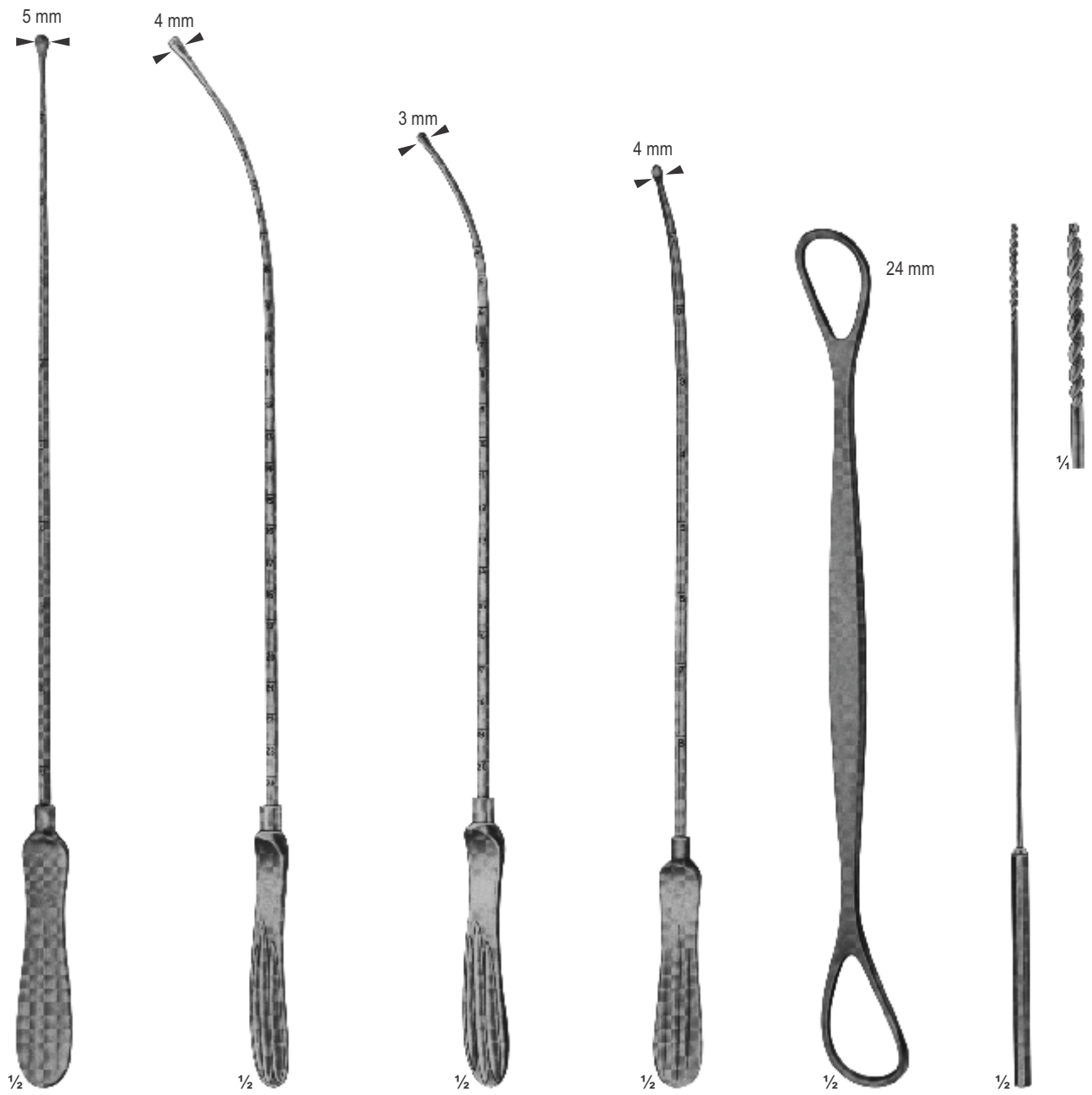

CM16-058
MAYO
biegsam malleable
330 mm

CM16-059
SIMS
biegsam malleable
330 mm

CM16-060
MARTIN
330 mm

CM16-061
SIMPSON
malleable
silver-plated
290 mm

CM16-062
BRAUN
Uterine
depressor
270 mm

CM16-063
Cotton
applicator
270 mm

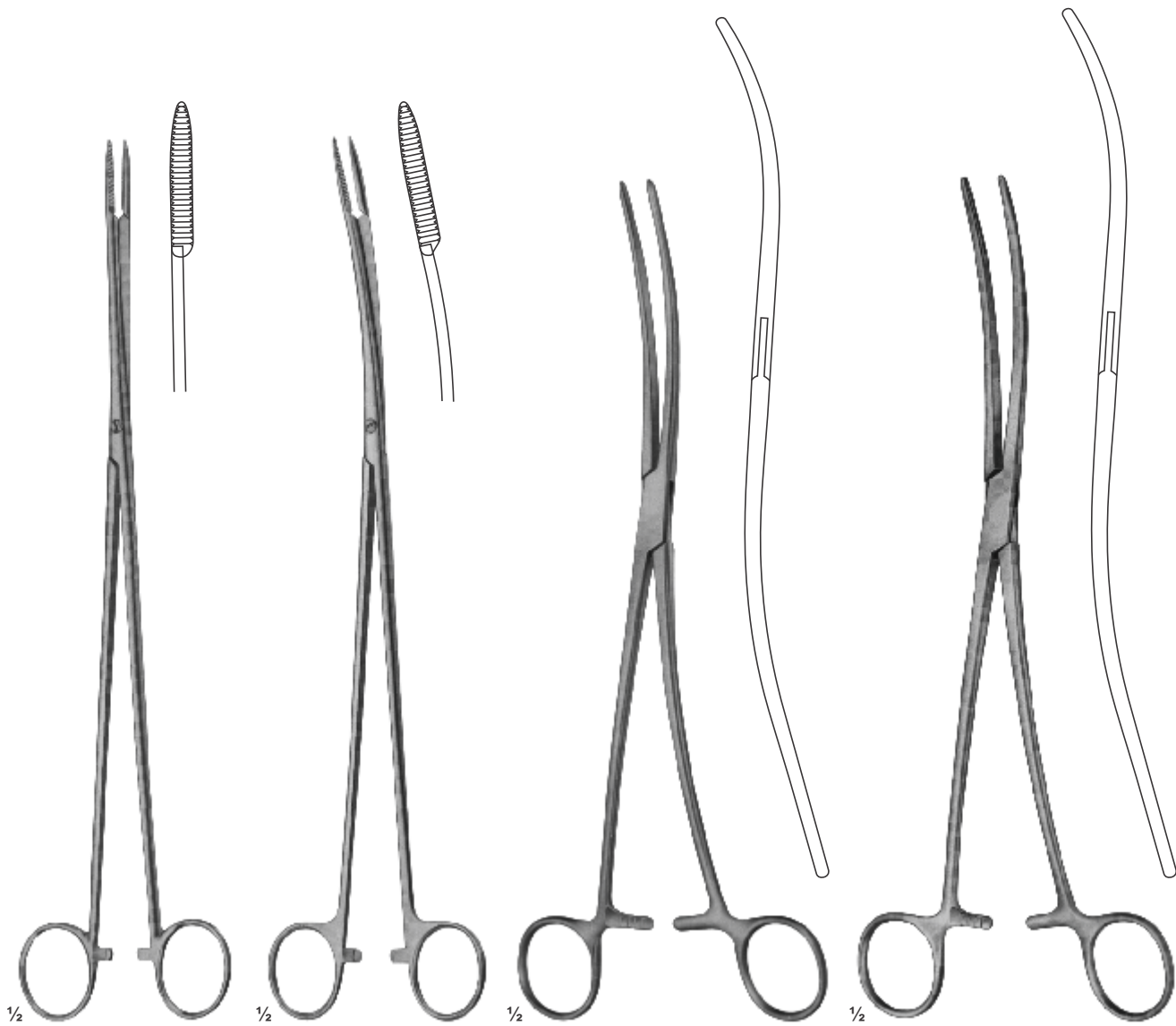

CM16-064
PELKMANN
260 mm

CM16-065
PELKMANN
260 mm

CM16-066
BOZEMANN
250 mm

CM16-067
BOZEMANN
255 mm

Jaws with longitudinal groove

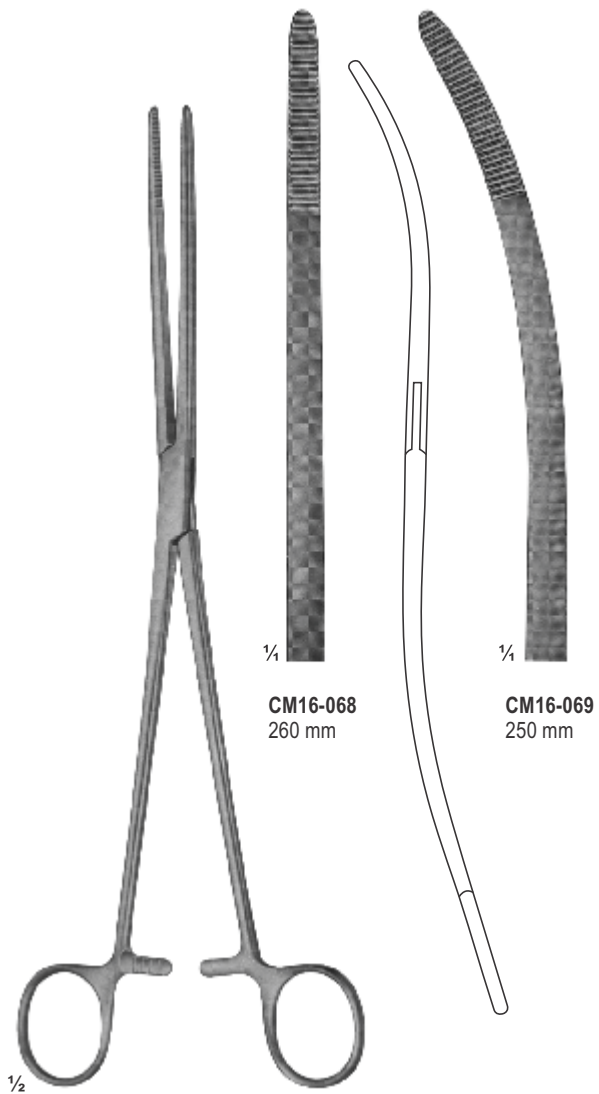

CM16-068 - CM16-069
BOZEMANN

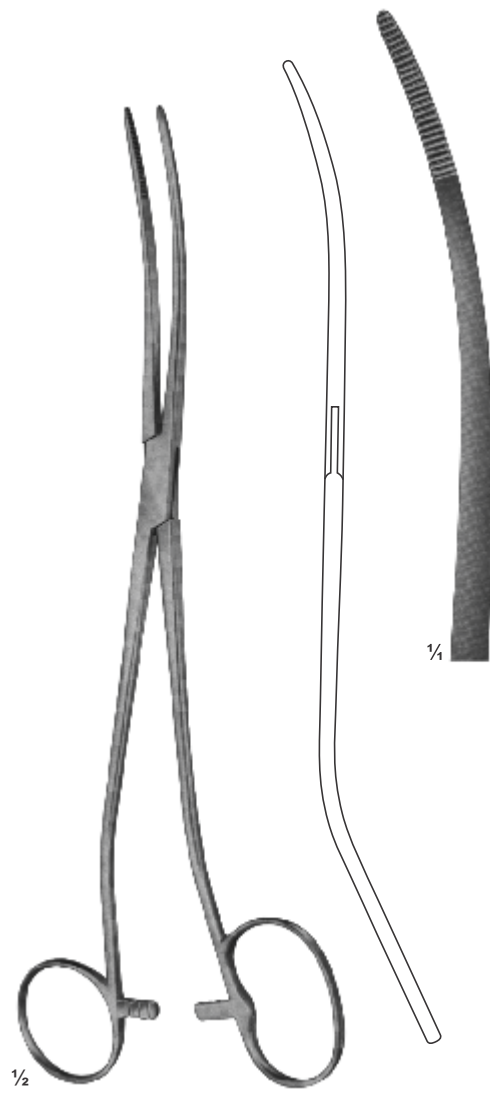

CM16-070
BOZEMANN-DOUGLAS
260 mm

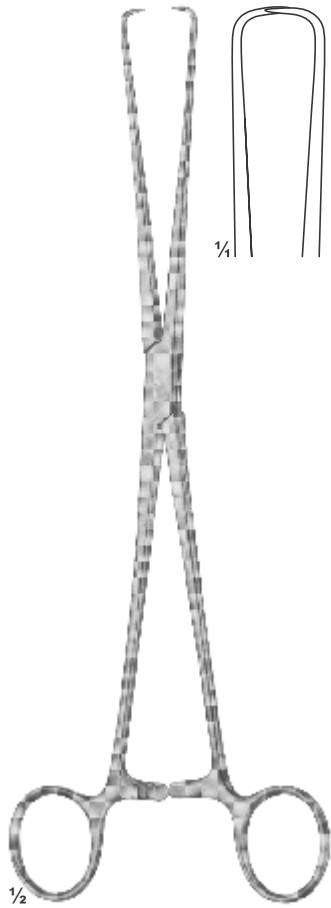

CM16-071
BRAUN
slender type
250 mm

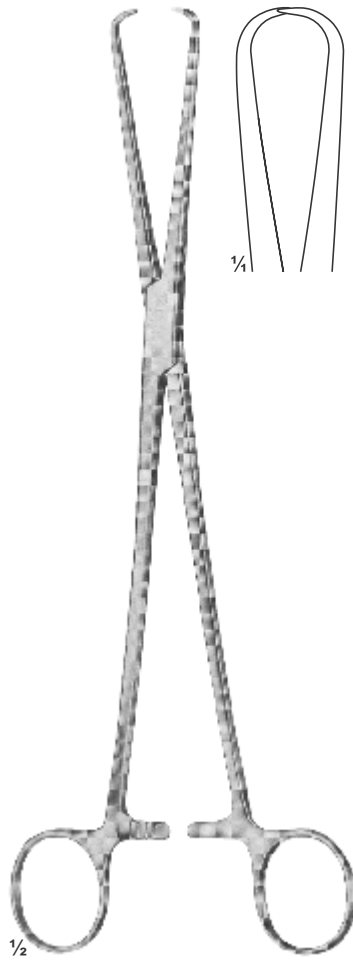

CM16-072
SCHRODER
250 mm



CM16-073
POZZI
heavy type
255 mm

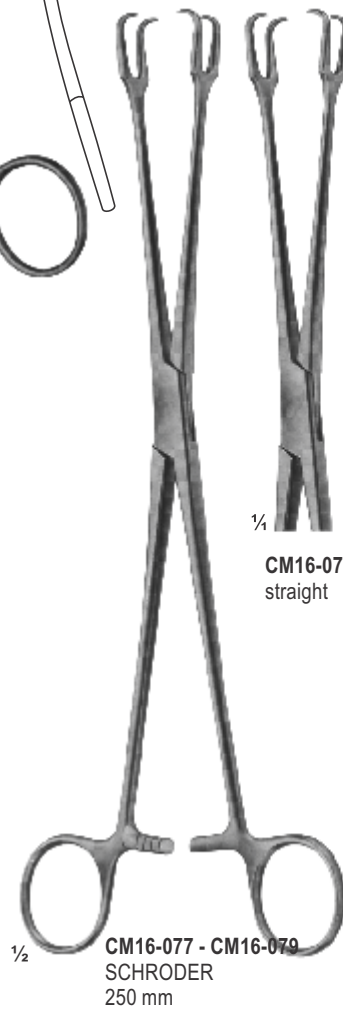
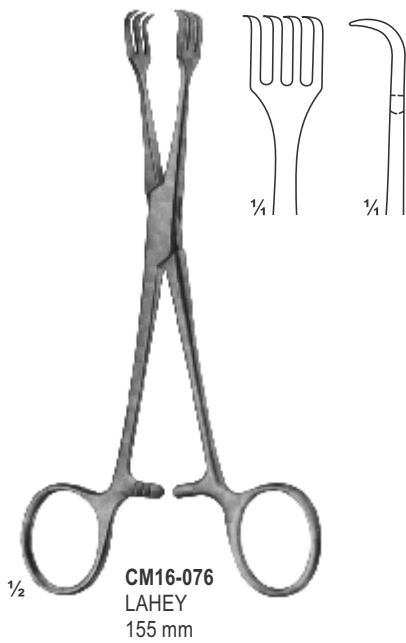
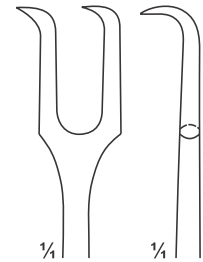
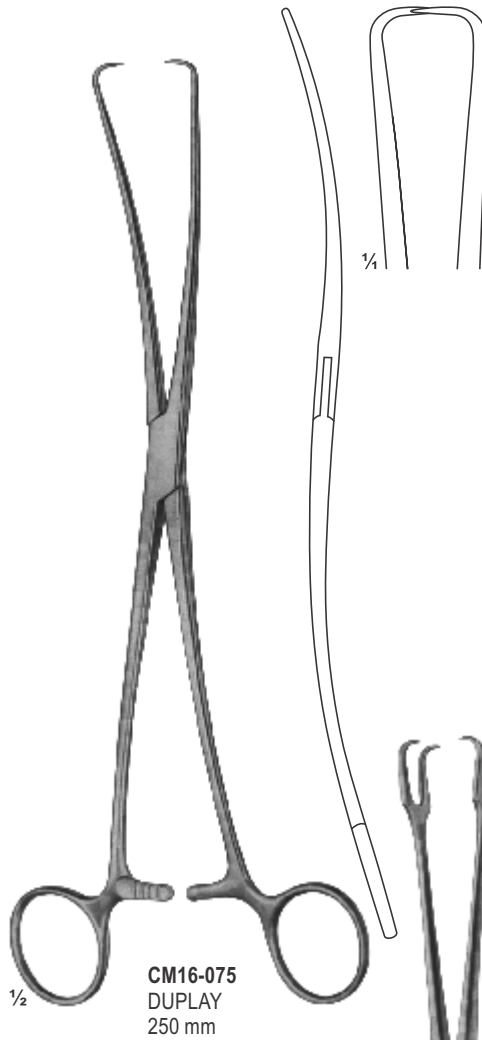
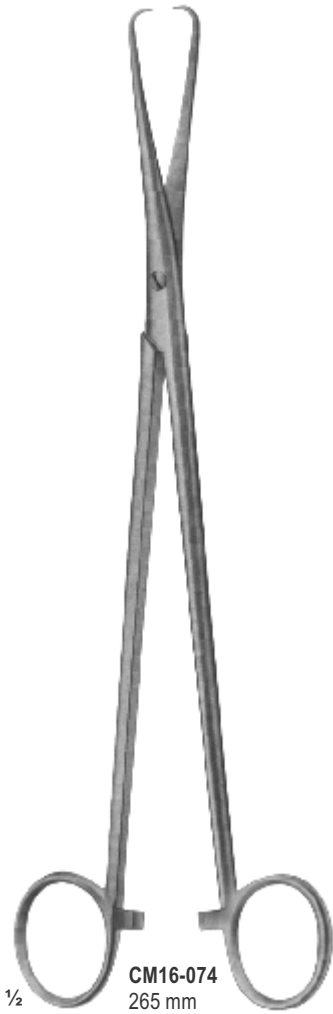

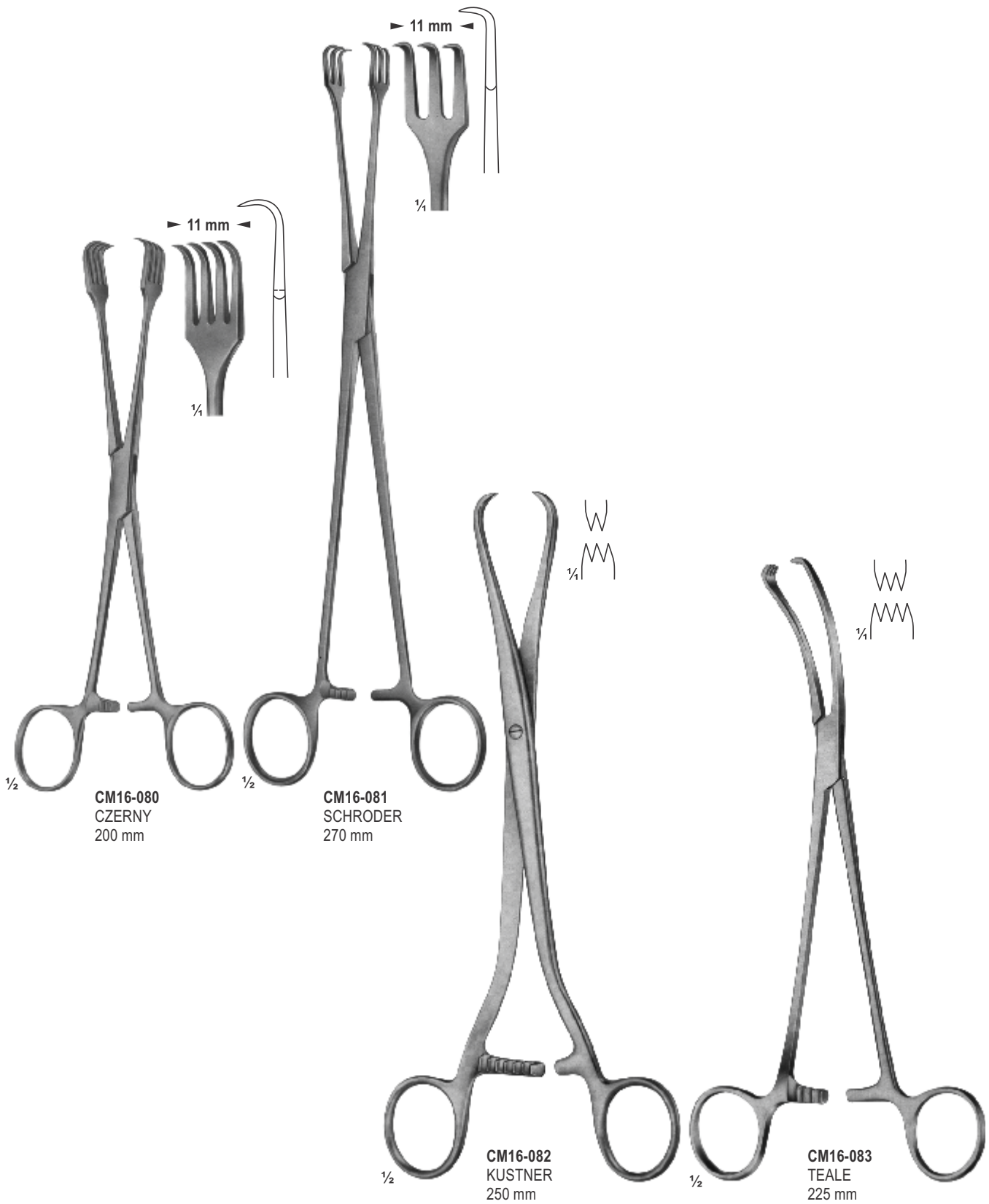

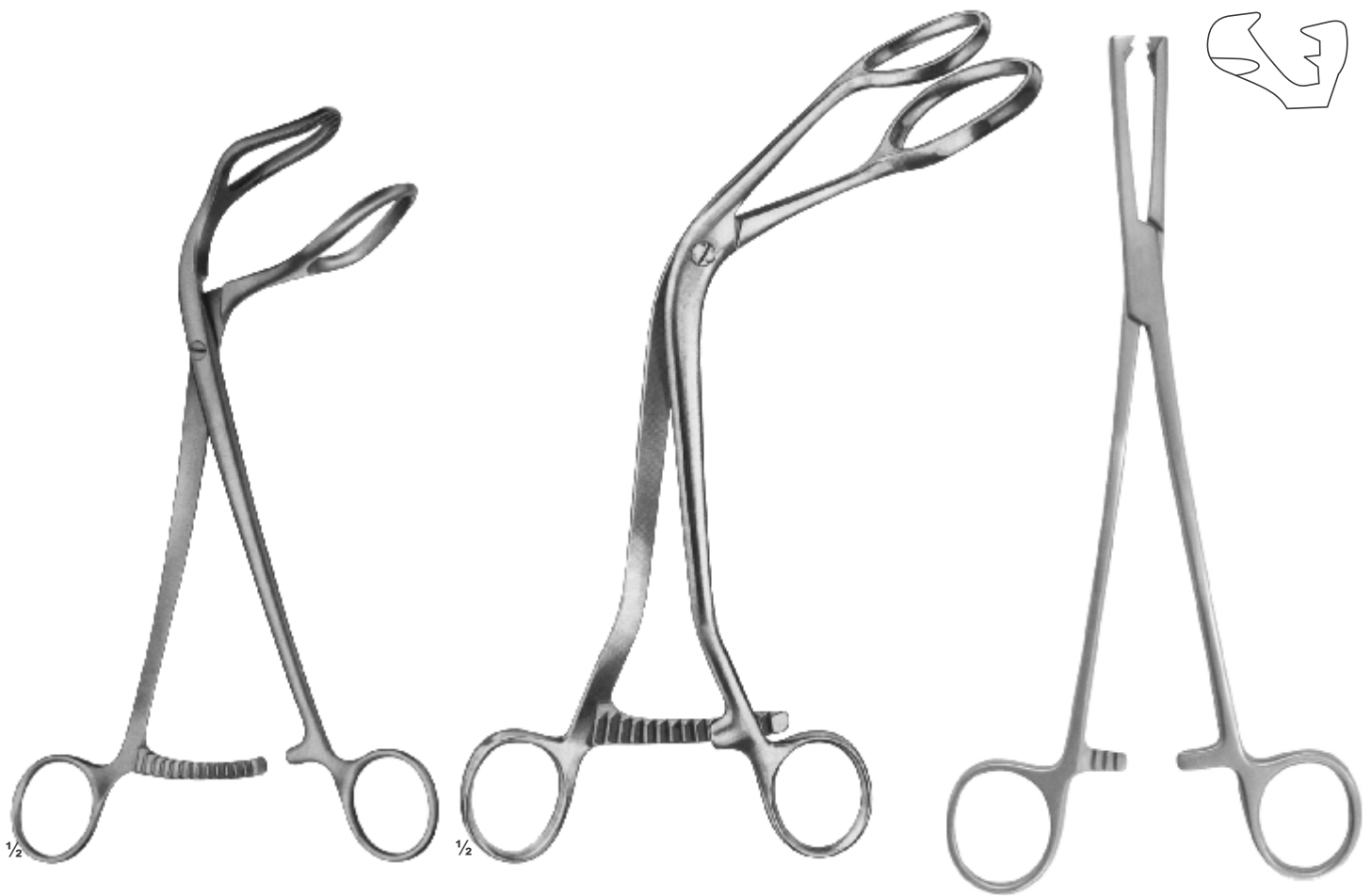

1/2

CM16-084
SOMER
235 mm

1/2

CM16-085
STRASSMANN
260 mm

CM16-086
JACOBS
8.5 mm

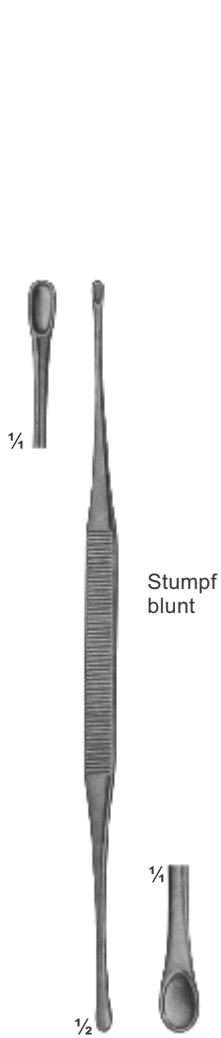

CM16-087
ASCH
Uterine
Secretion scoop
200 mm

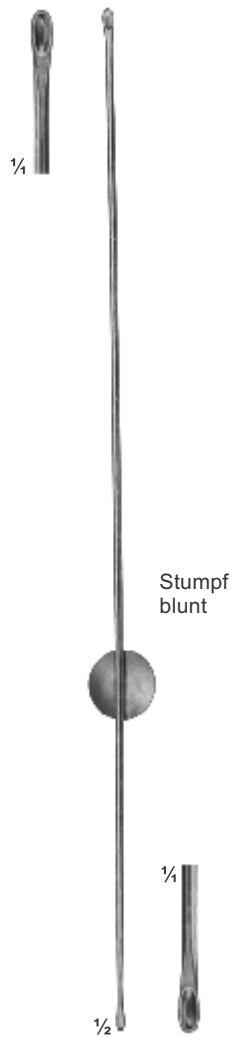

CM16-088
Uterine
Secretion scoop
270 mm



CM16-089
NOVAK-SCHOECKAERT
Endometrial biopsy
curette
240 mm



CM16-090
RANDALL
Endometrial biopsy
curette
240 mm

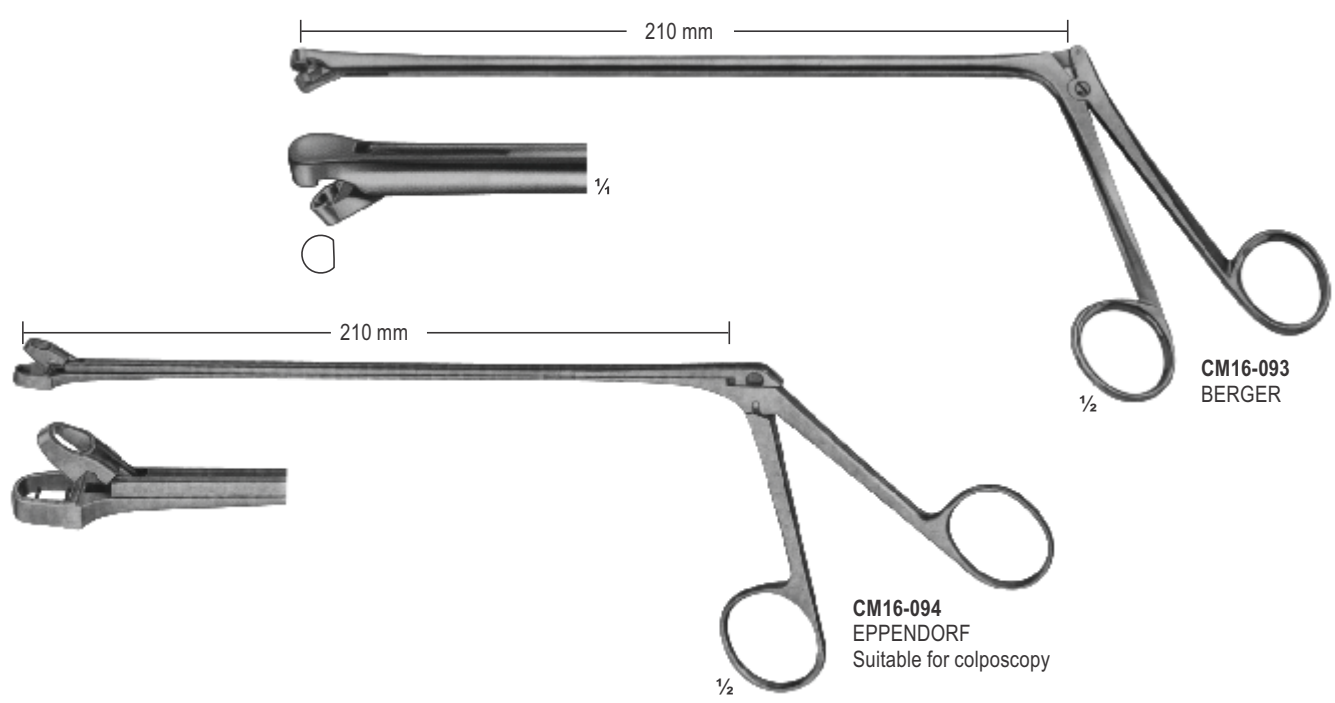
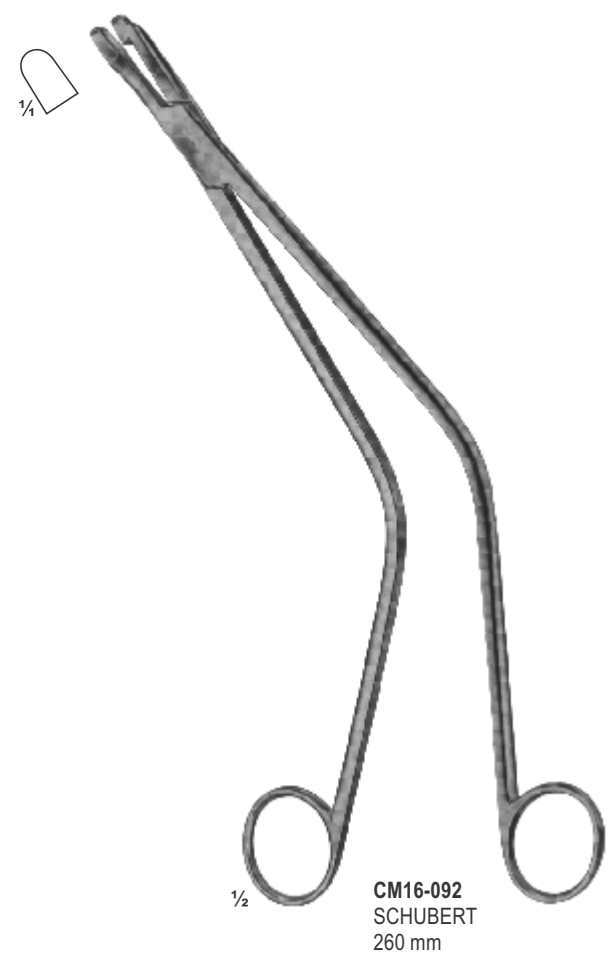
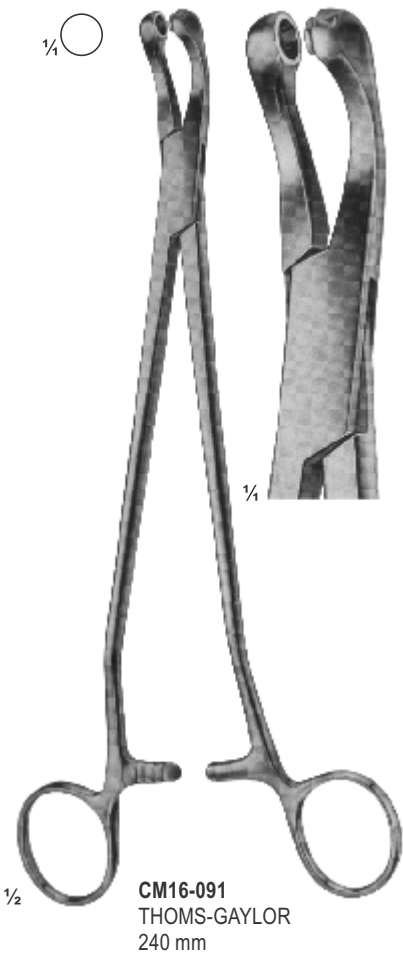

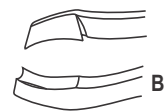
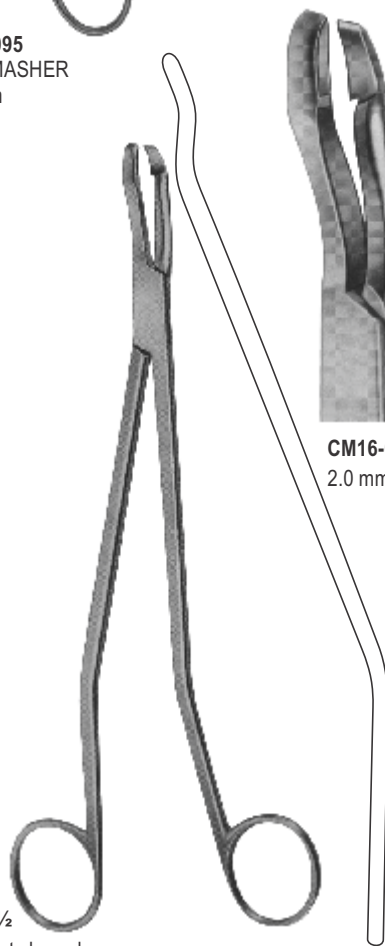
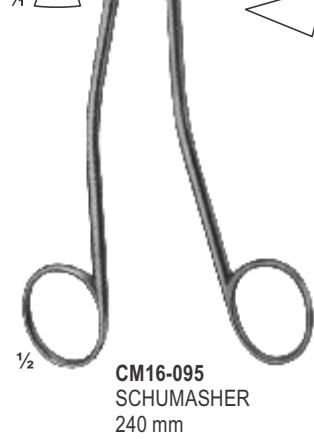
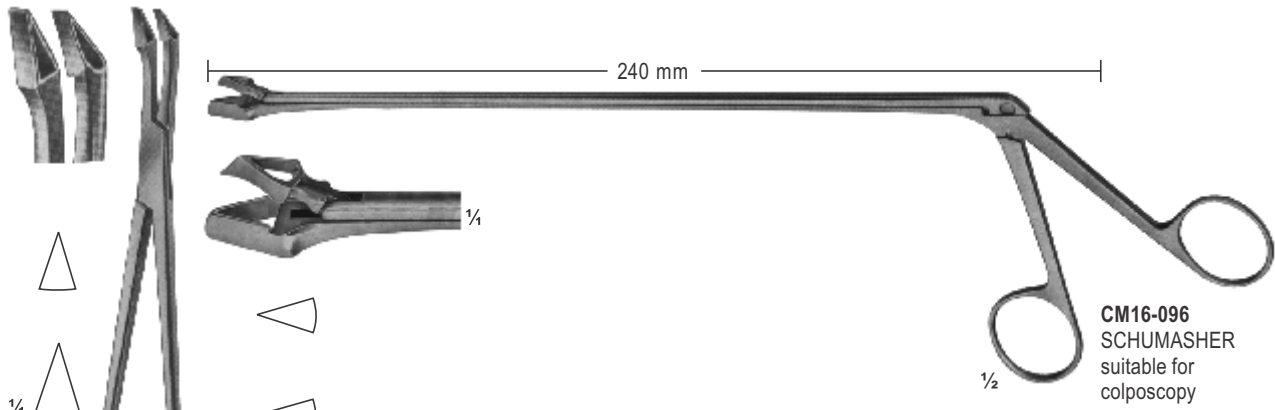

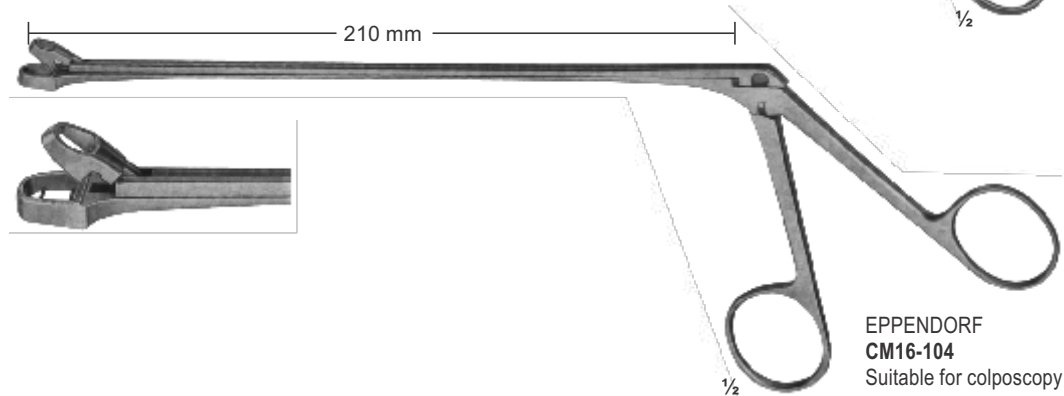
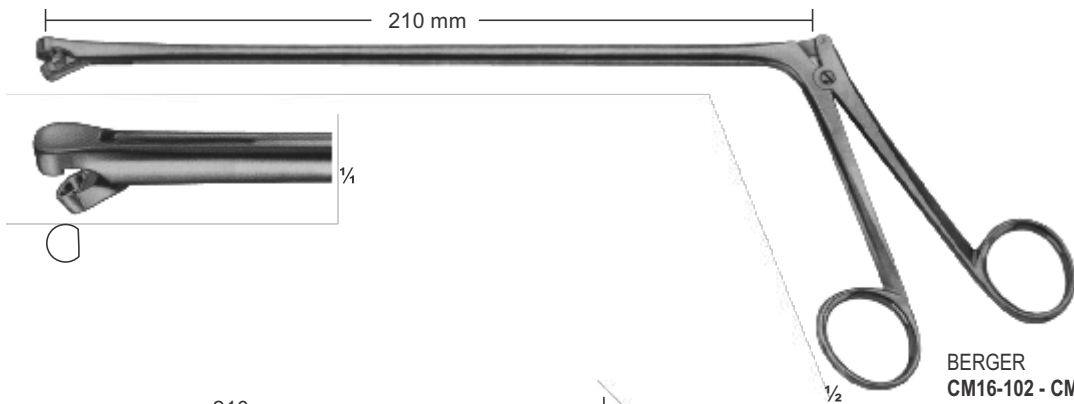
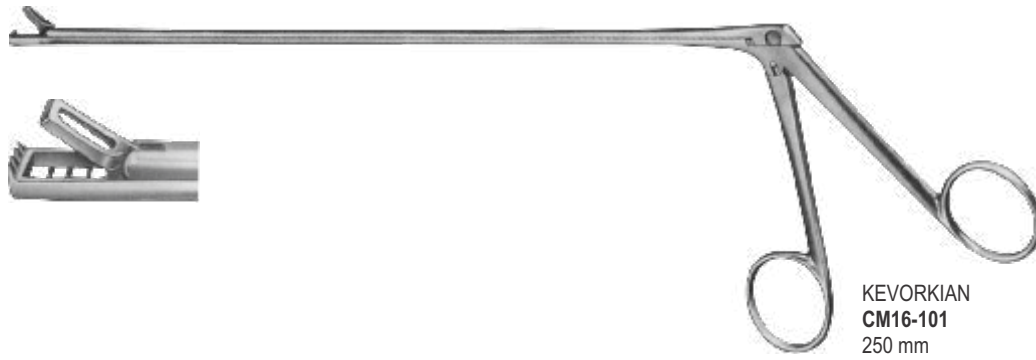
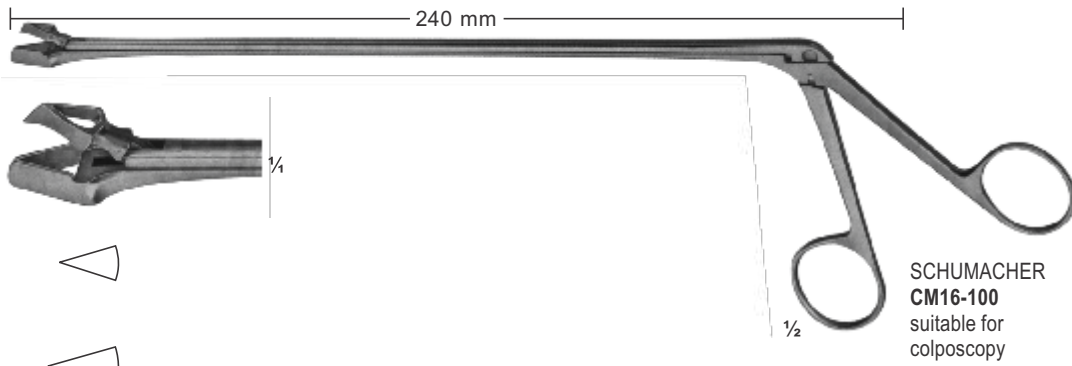

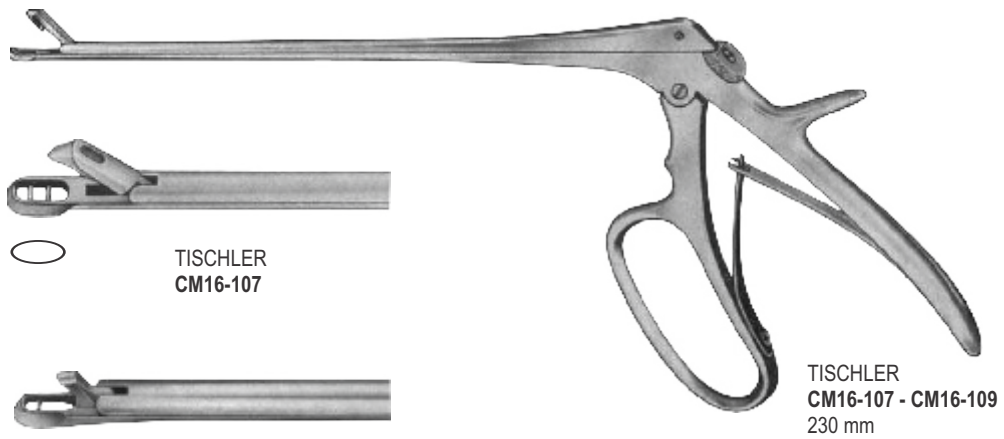

TISCHLER
CM16-107

TISCHLER-MINI
CM16-108

KEVORKIAN-PACIFIC
CM16-109

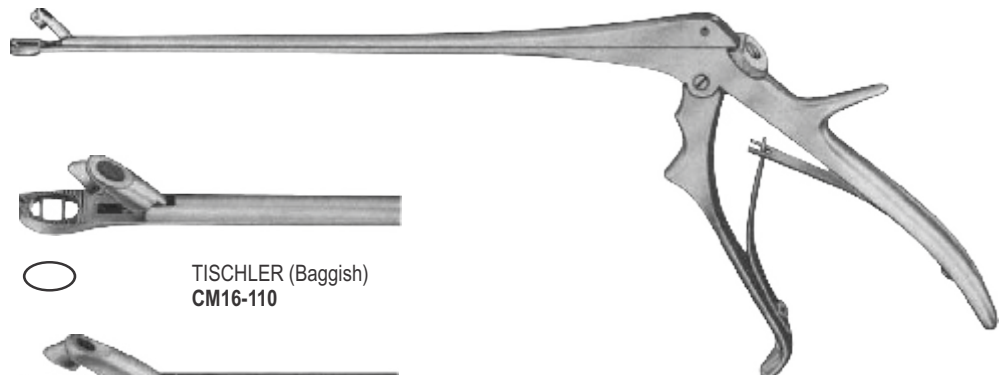

TISCHLER (Baggish)
CM16-110

TISCHLER-BURKE
CM16-111

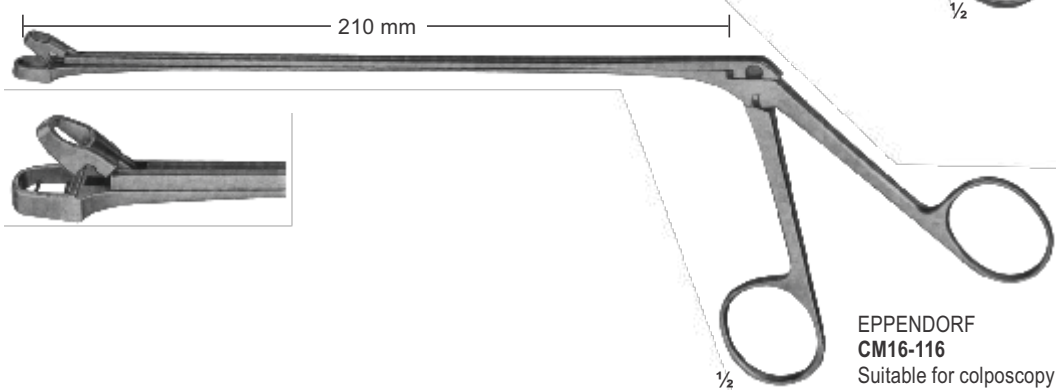
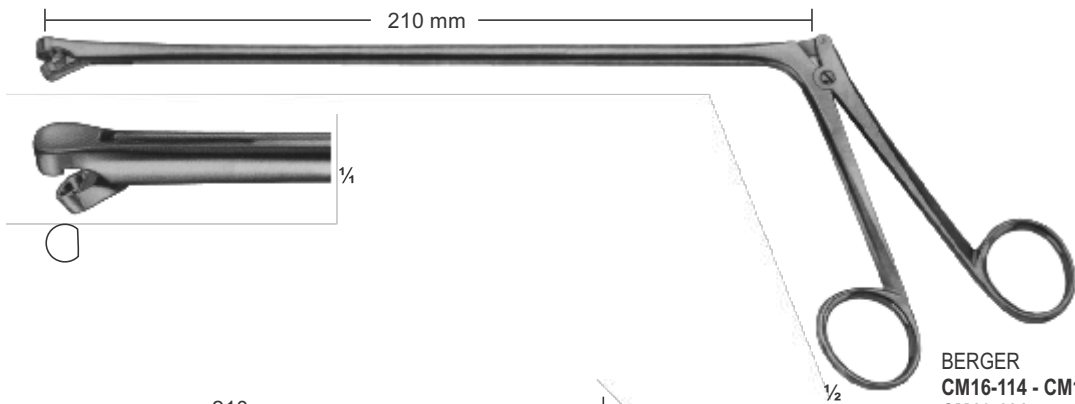
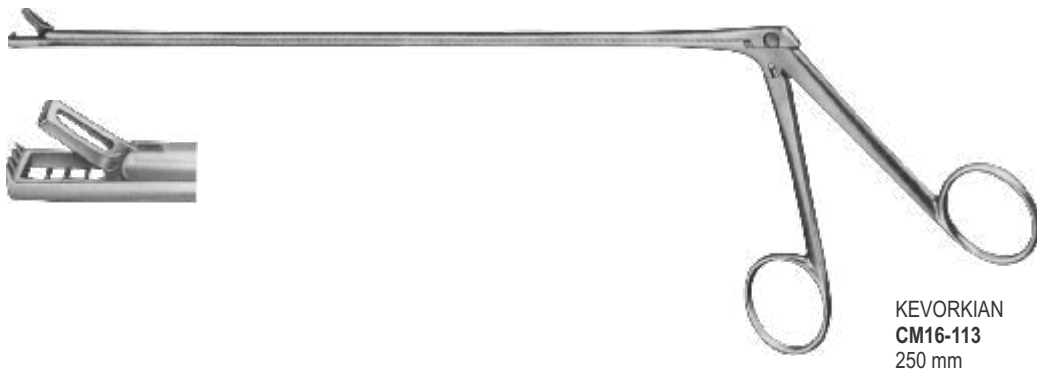
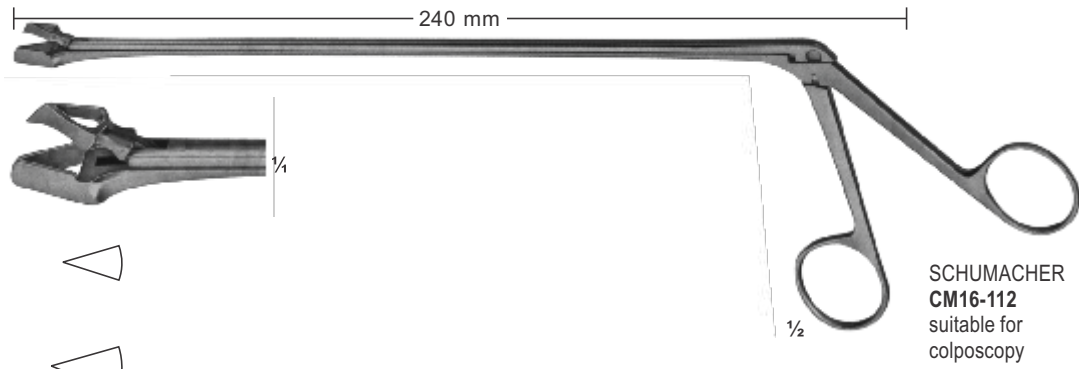

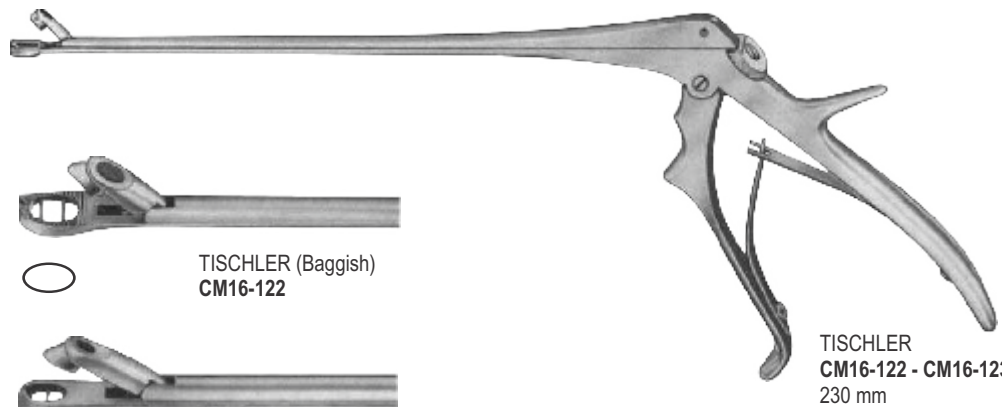
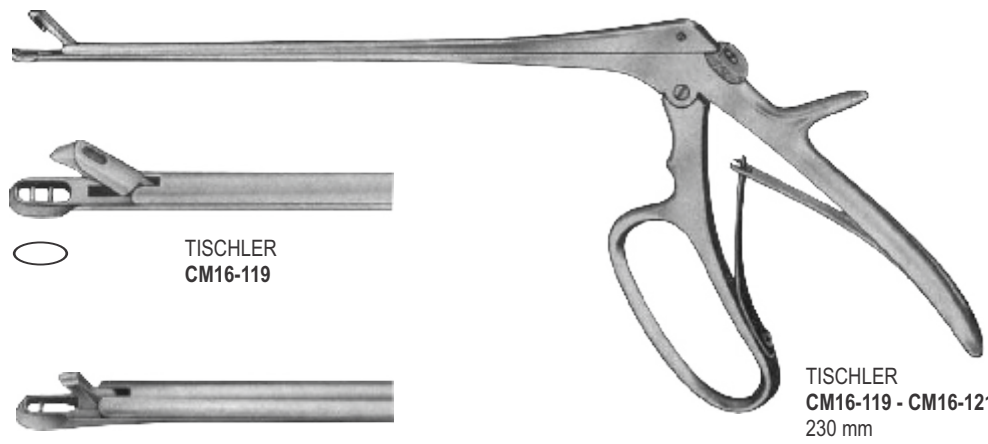

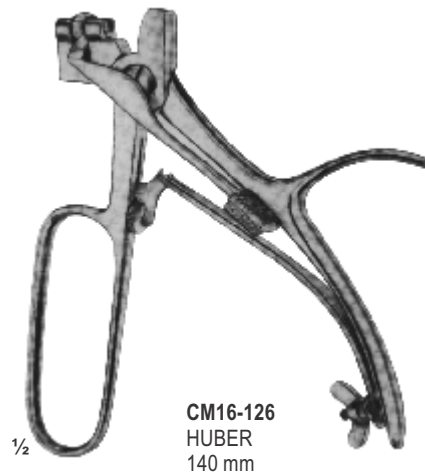
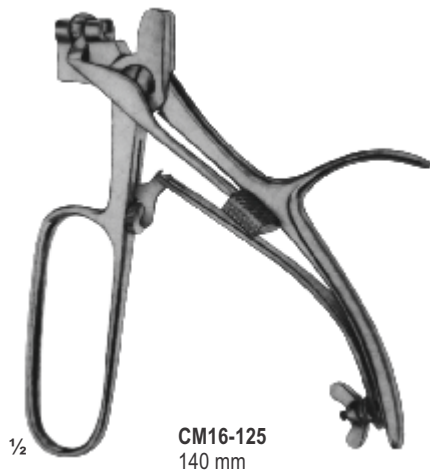
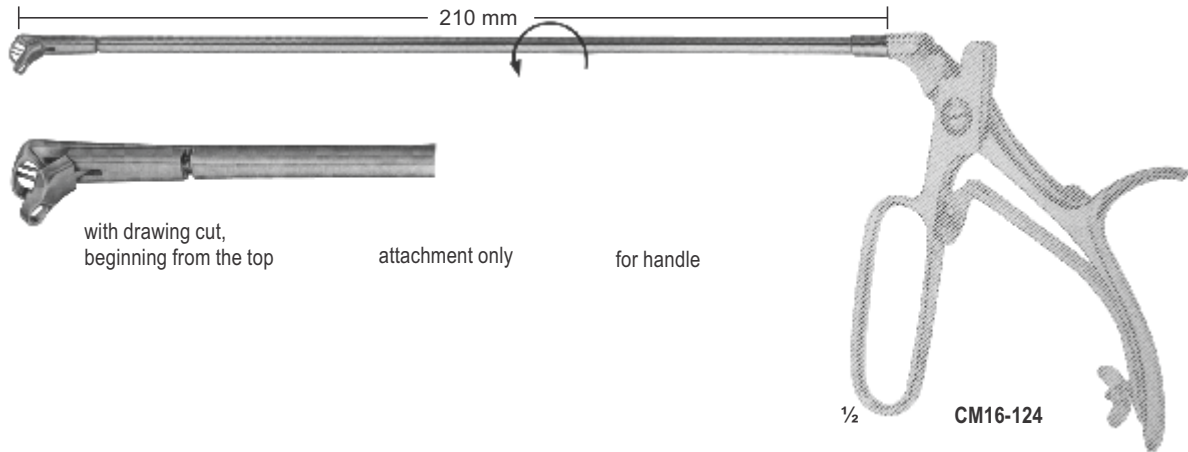

CM16-127 BRUENINGS 200 mm Length
 CM16-128 BRUENINGS 250 mm Length

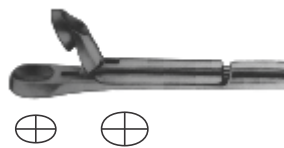

CM16-129 KRAUSE (Biopsy tip)



CM16-130 SCHEINMANN (Biopsy tip)



CM16-131 SCHEINMANN (Biopsy tip)
with drawing cut

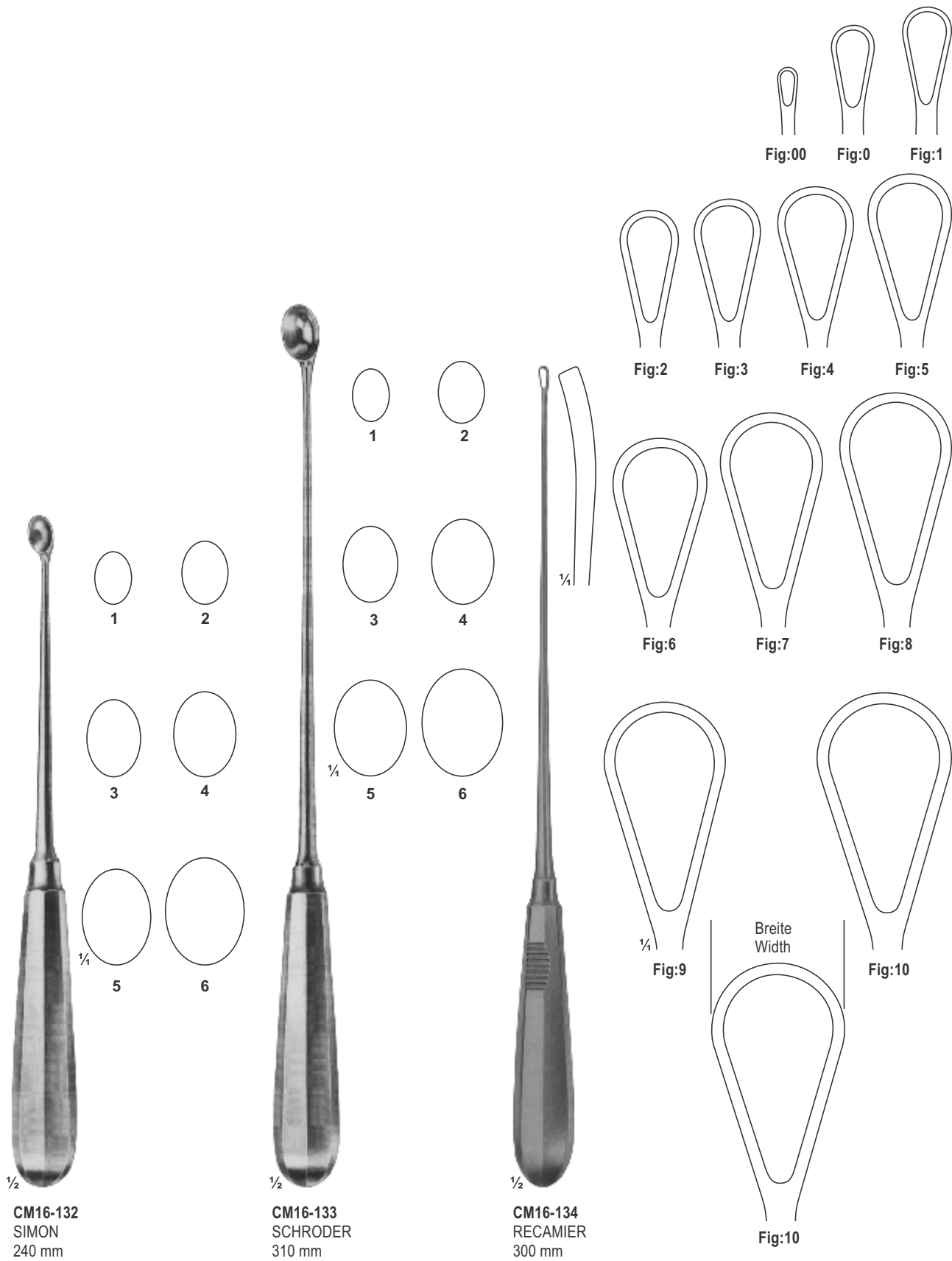

CM16-132
SIMON
240 mm

CM16-133
SCHRODER
310 mm

CM16-134
RECAMIER
300 mm

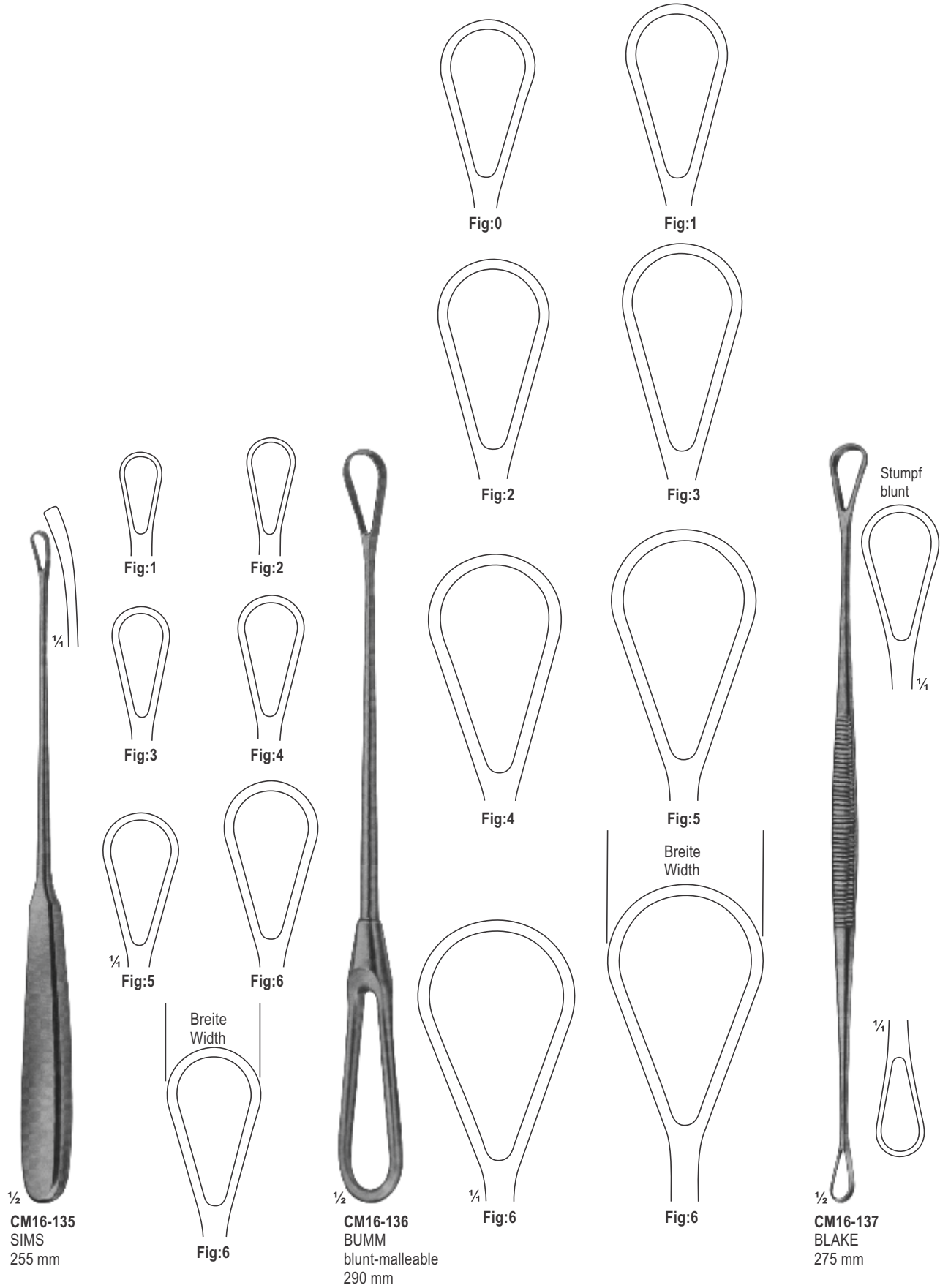



1/4



1/2

CM16-138
COLLIN
300 mm



1/2

CM16-139
RECAMIER
blunt-rigid
360 mm

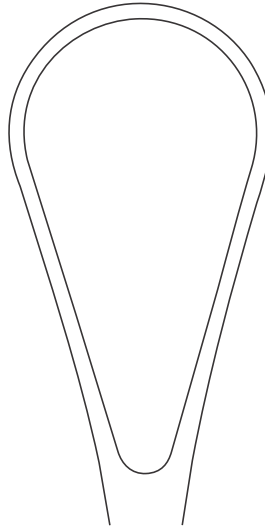
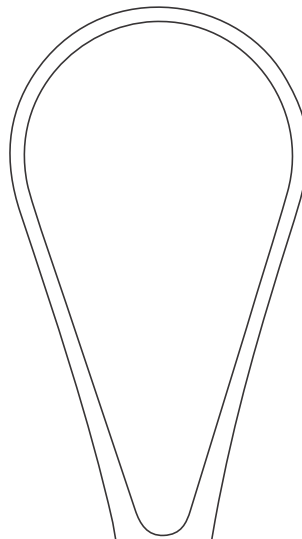

Fig:1



1/4

Fig:2



1/2

CM16-140
BUMM
310 mm

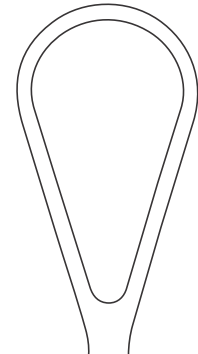

Fig:1

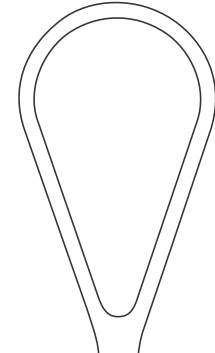
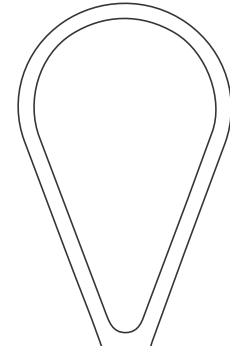
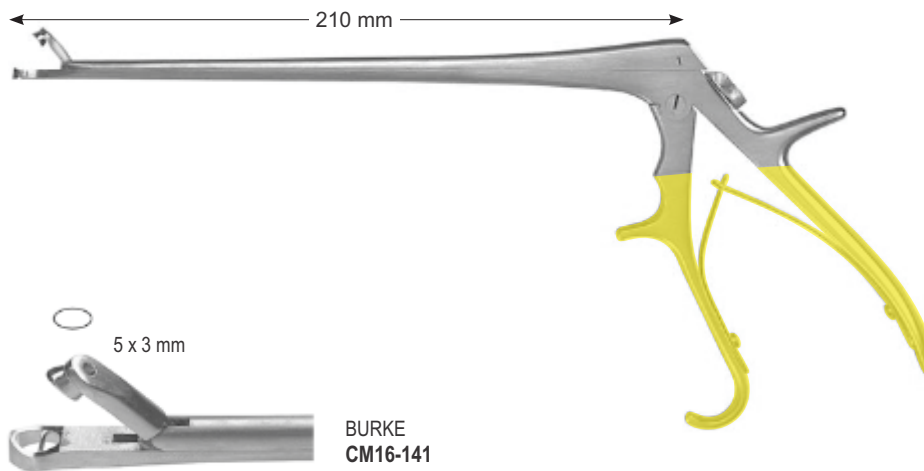

Fig:2



1/4

Fig:3



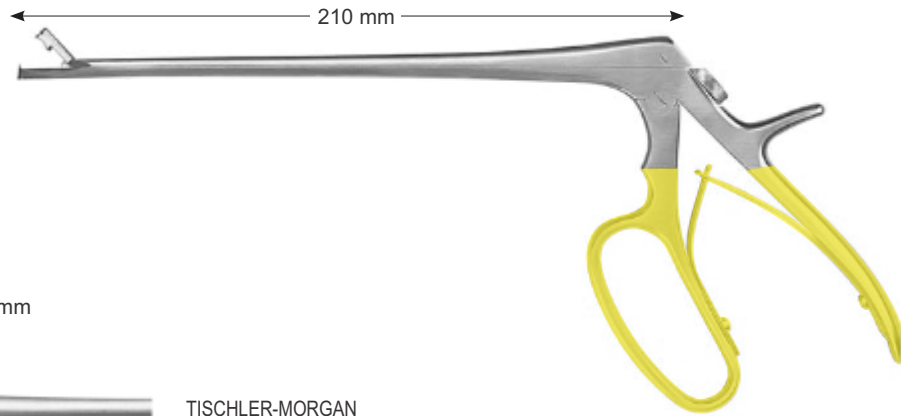

7 x 3 mm



TISCHLER-MORGAN
CM16-142

2.3 x 4 mm



MINI-TOWNSEND
CM16-143

9 x 3 mm



TISCHLER-KEVORKIAN
CM16-145

2.3 x 4 mm



BABY-TISCHLER
CM16-144

9 x 3 mm



KEVORKIAN-PACIFIC
CM16-146



CARE MEDICAL[®]
SUPPLIES

Your health _ Our Priority

Section

17

Page 294-302

Obstetrics-placenta And Ovum Cranioclast, Basiotribe Forceps
Placenta Scoops, Umbilical Cord Clamps
Obstetrics-placenta And Ovum Forceps, Perforator Cranioclast
Tound, Tracheal Hooks And Tracheal Dilators

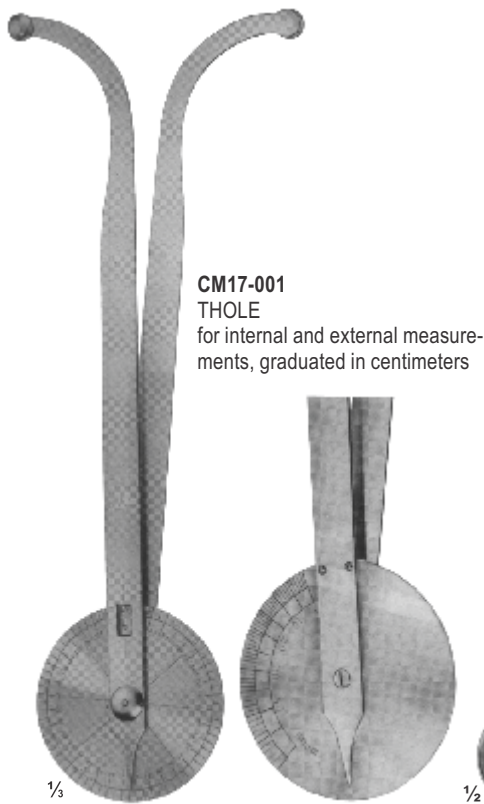

CM17-001
THOLE
for internal and external measurements, graduated in centimeters

1/3



CM17-002
DE LEE
graduated in centimeters and inches

for internal measurements between symphysis and promontory

1/2



CM17-003
COLLIN
graduated in centimeters

1/3



CM17-004
MARTIN
graduated in centimeters

1/3



CM17-005
COLLIN
graduated in centimeters

The additional straight arm can be replaced. The pelvimeter with straight arm is used for localisation of the portio vaginalis uteri and of vaginal metastasis.

1/3



CM17-006
BREISKY
graduated in centimeters

1/3

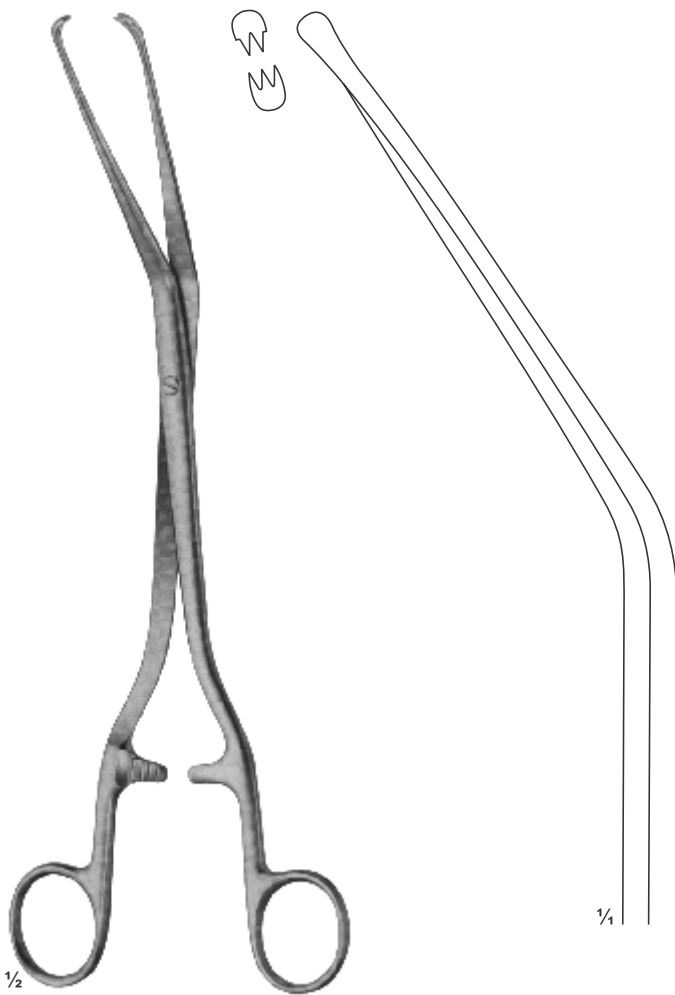

CM17-007
HERFF
puncturing forceps
225 mm



CM17-008
IOWA
puncturing forceps
260 mm



CM17-009
SIMPSON-BRAUN
305mm



CM17-010
355 mm

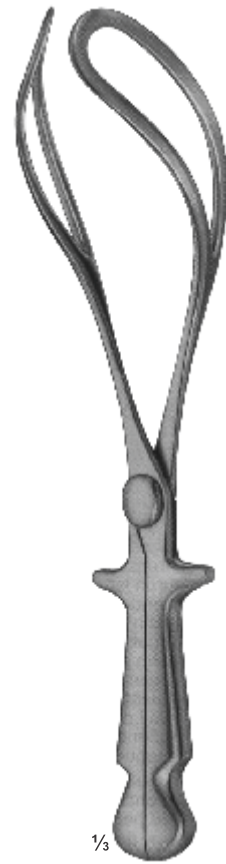

CM17-011
400 mm



CM17-012
SIMPSON-BRAUN
305mm



CM17-013
SIMPSON
235mm

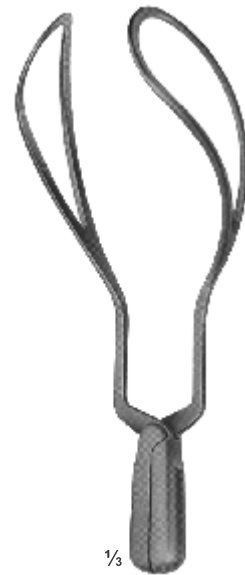

CM17-014
WRIGLEY
250 mm

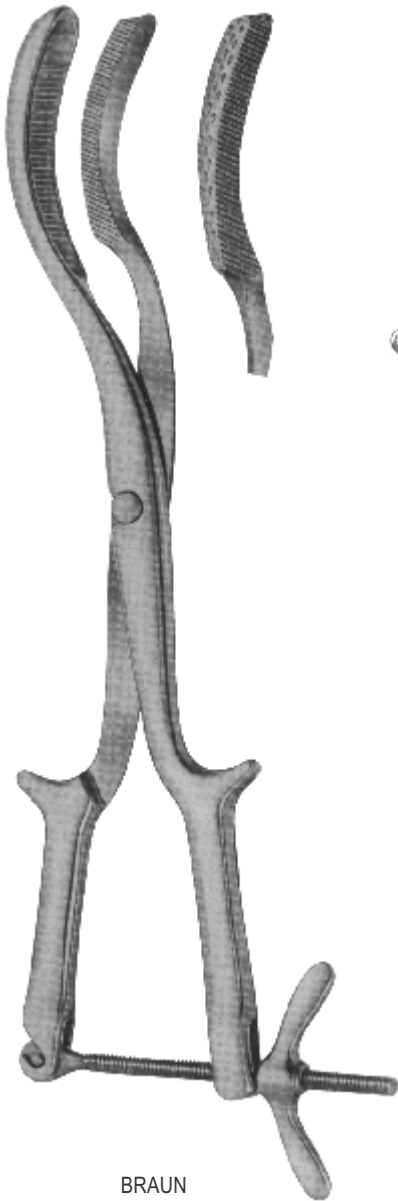

BRAUN
Cranioclast
CM17-015
420 mm

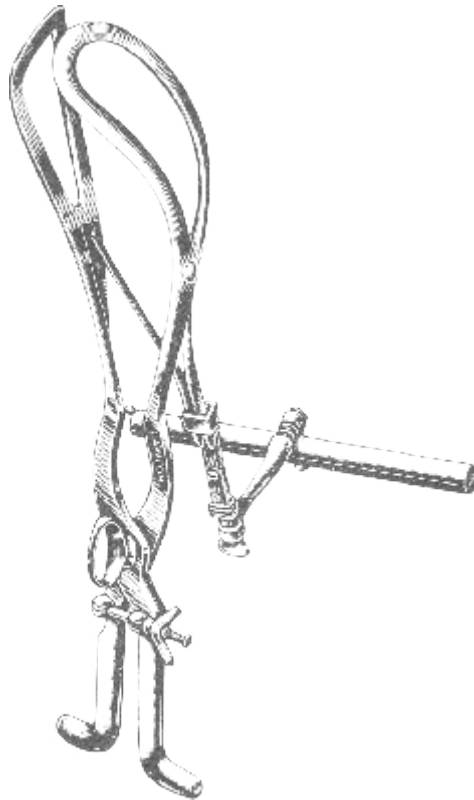

TARNIER
CM17-016
400 mm

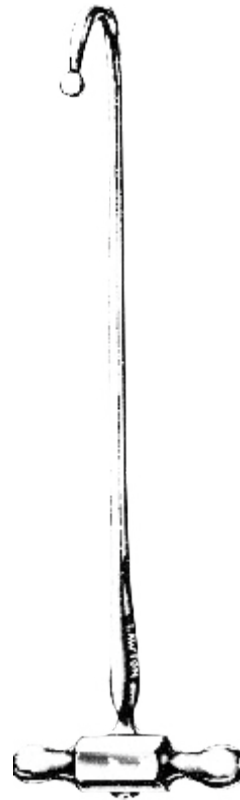

BRAUN
CM17-017
310 mm



SMELLIE
CM17-018
305 mm



BOER
CM17-019
290 mm



SMELLIE
Perforator
CM17-020
270 mm



GREEN-ARMYTAGE
CM17-021
Caesarean section haemostatic
forceps, for edges of the transverse
incision in the lower segment
220 mm

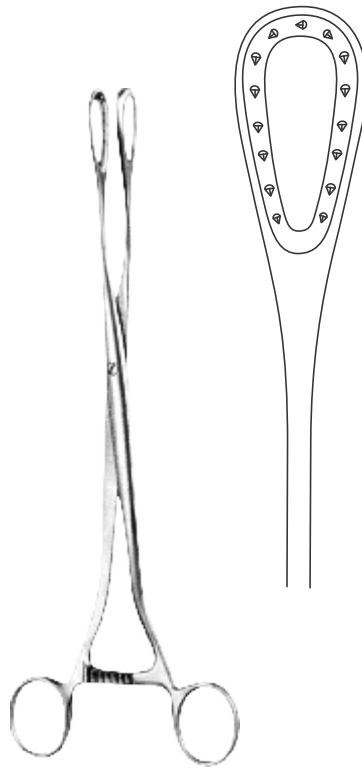

SANGER
CM17-022
275 mm

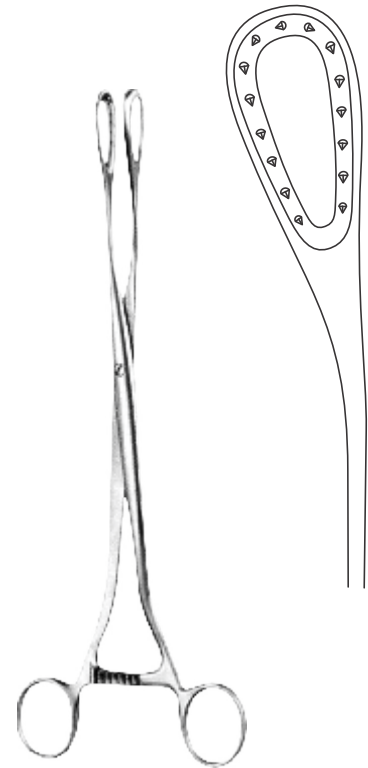

SANGER
CM17-023 - 024
CM17-023 270 mm
CM17-024 290 mm



GAUSS
CM17-025
Scalpel Flap
forceps
260 mm



WILLETT
CM17-026
Scalpel Flap
forceps
185 mm



SELLHEIM
CM17-027
320 mm

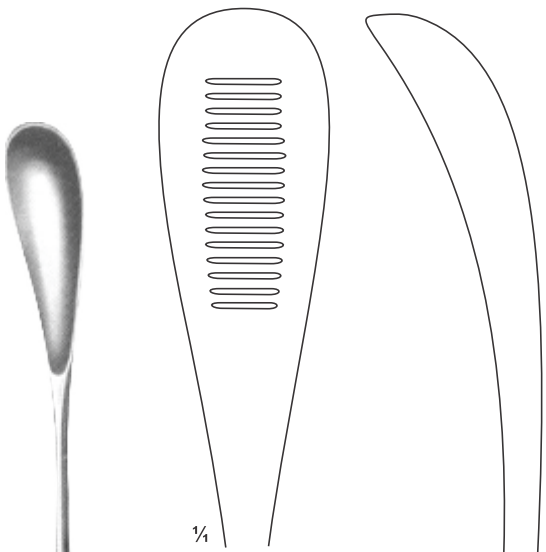

CUZZI
CM17-028 - 030
300 mm

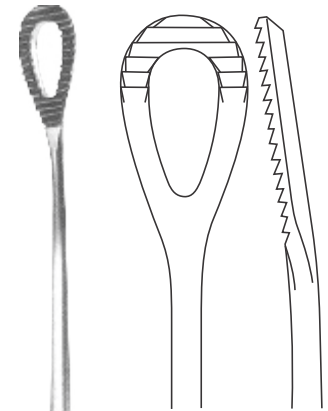
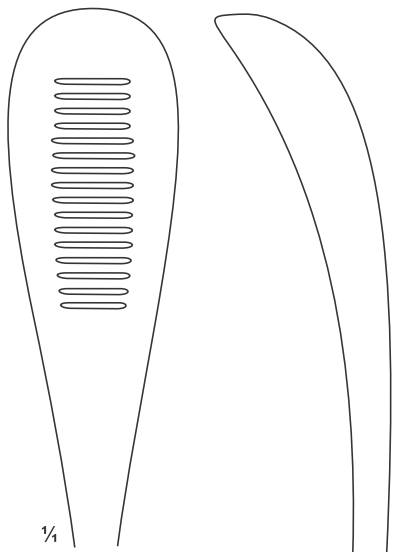

PESTALOZZA
CM17-031
305 mm

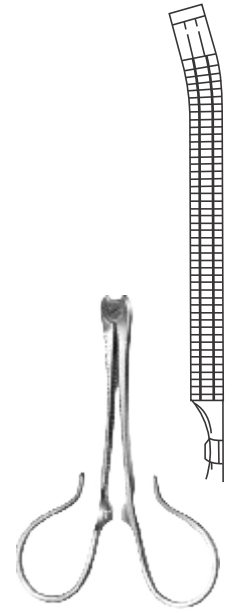

KANE
CM17-032
85 mm



COLLIN
CM17-033
85 mm

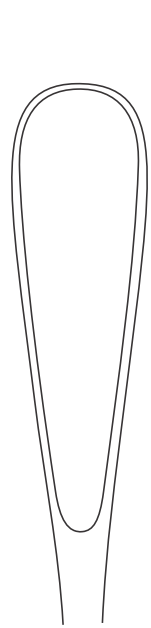

CM17-028
17 mm

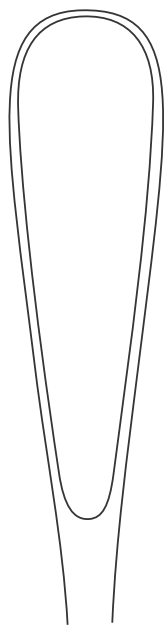

CM17-029
20 mm

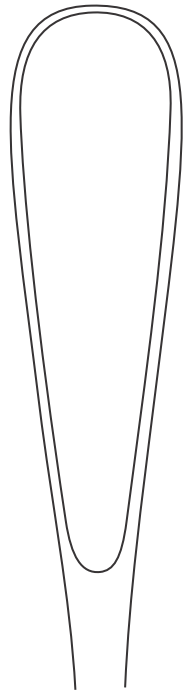

CM17-030
23 mm



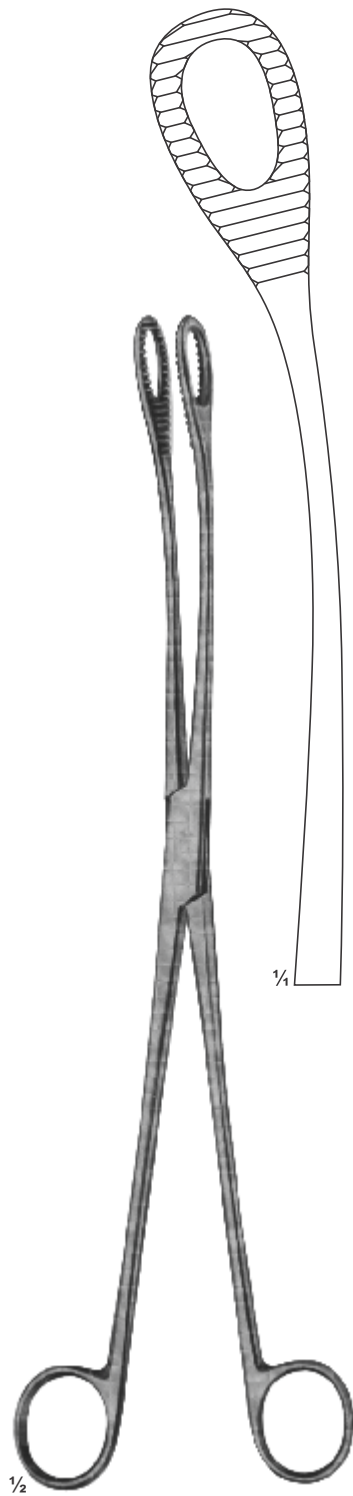

CM17-041
KELLY
320mm



CM17-042
SMELLIE
Perforator
270mm

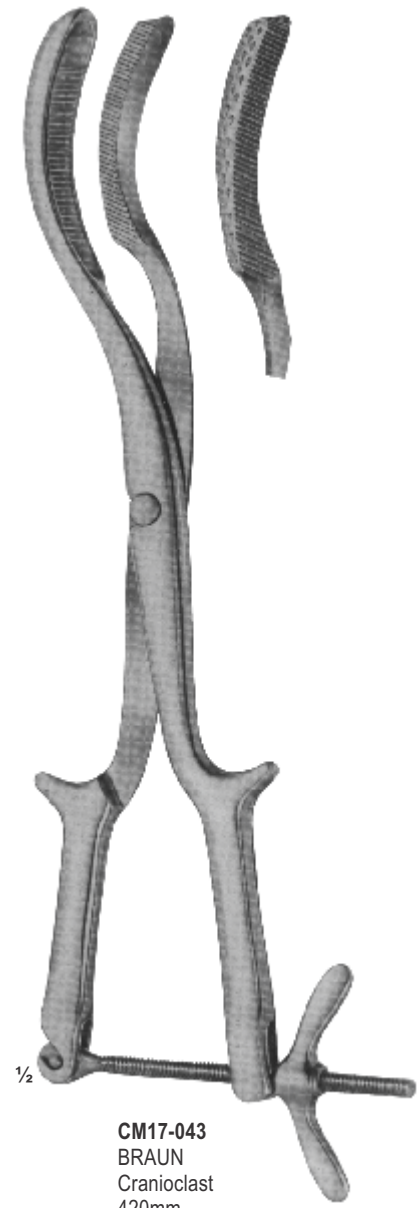

CM17-043
BRAUN
Cranioclast
420mm



CM17-044
BOSE
165 mm



CM17-045
BOSE
165 mm



CM17-046 - 048
180 mm



CM17-046
sharp



CM17-047
blunt

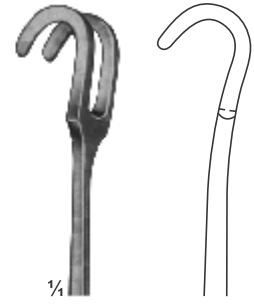

CM17-048
stumpf/blunt



CM17-049
FINSEN
50 mm

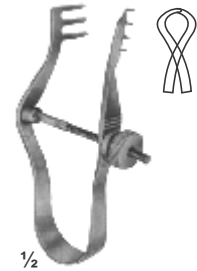

CM17-050
FINSEN
70 mm



CM17-051
TROUSSEAU
120 mm



CM17-052
LABORDE
125 mm

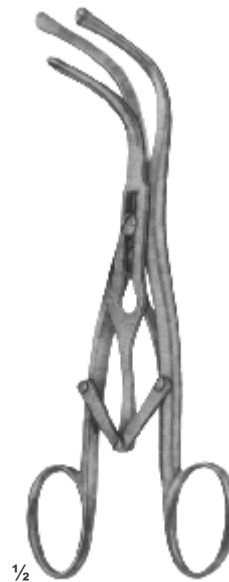

CM17-053
LABORDE
strong pattern
135 mm



CM17-054
Cleaning Brush
for tracheal tubes
285 mm



CARE MEDICAL[®]
SUPPLIES

Your health _ Our Priority

Section

18

Page 303-365

Obstetrics-placenta And Ovum Cranioclast, Basiotribe Forceps
Placenta Scoops, Umbilical Cord Clamps
Obstetrics-placenta And Ovum Forceps, Perforator Cranioclast
Tound, Tracheal Hooks And Tracheal Dilators

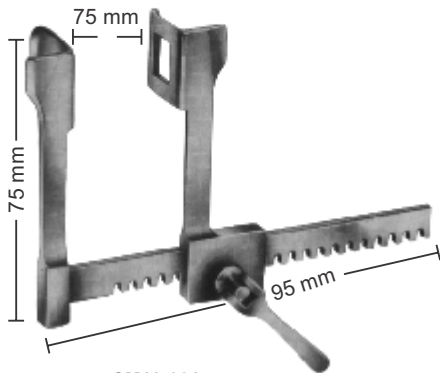

CM18-001
FINOCHIETTO
for children
18X21 mm

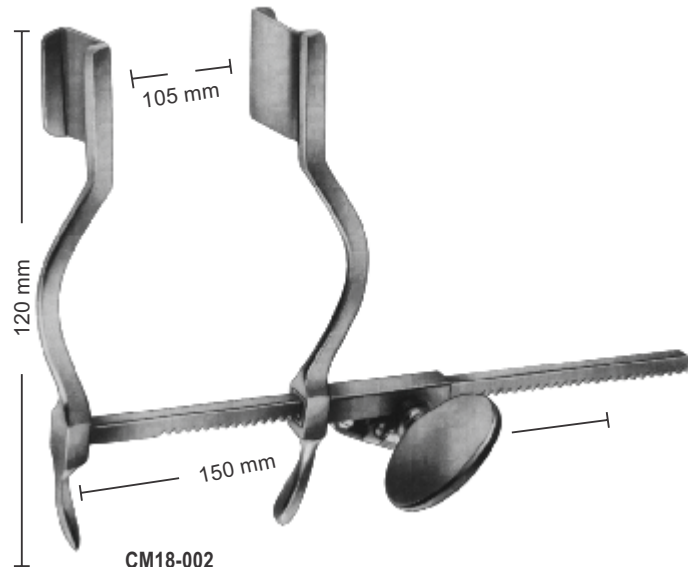

CM18-002
HERTZLER
for children
20X25 mm

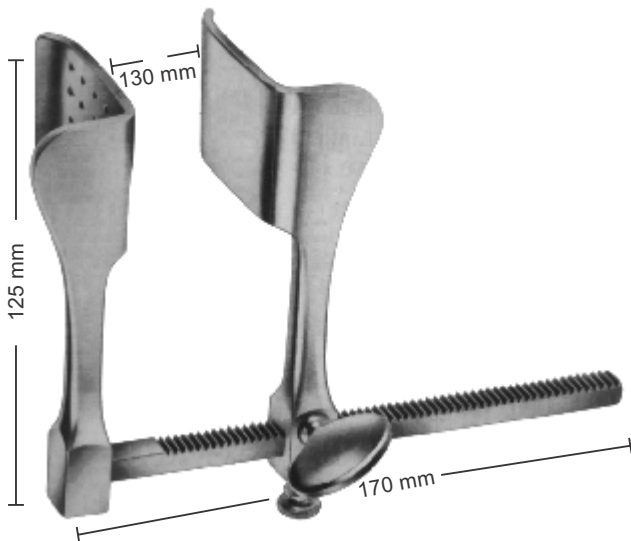

CM18-003
TUFFIER
Blades
43X53 mm

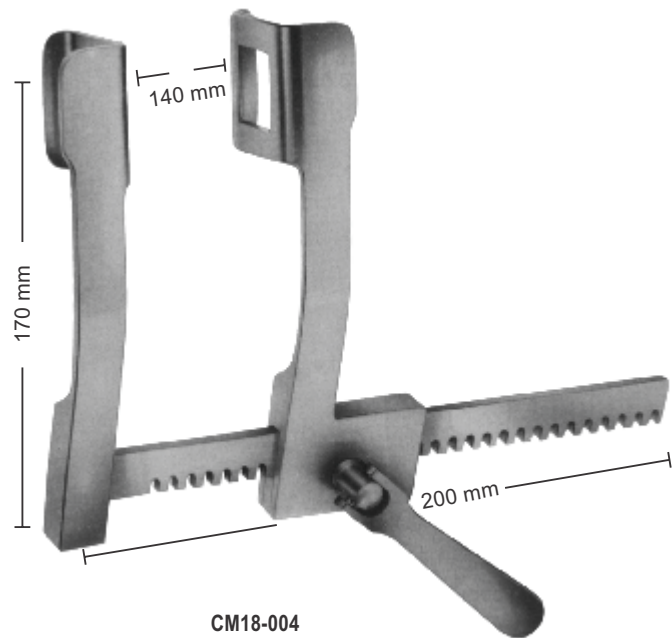

CM18-004
FINOCHIETTO
Blades
36X45 mm

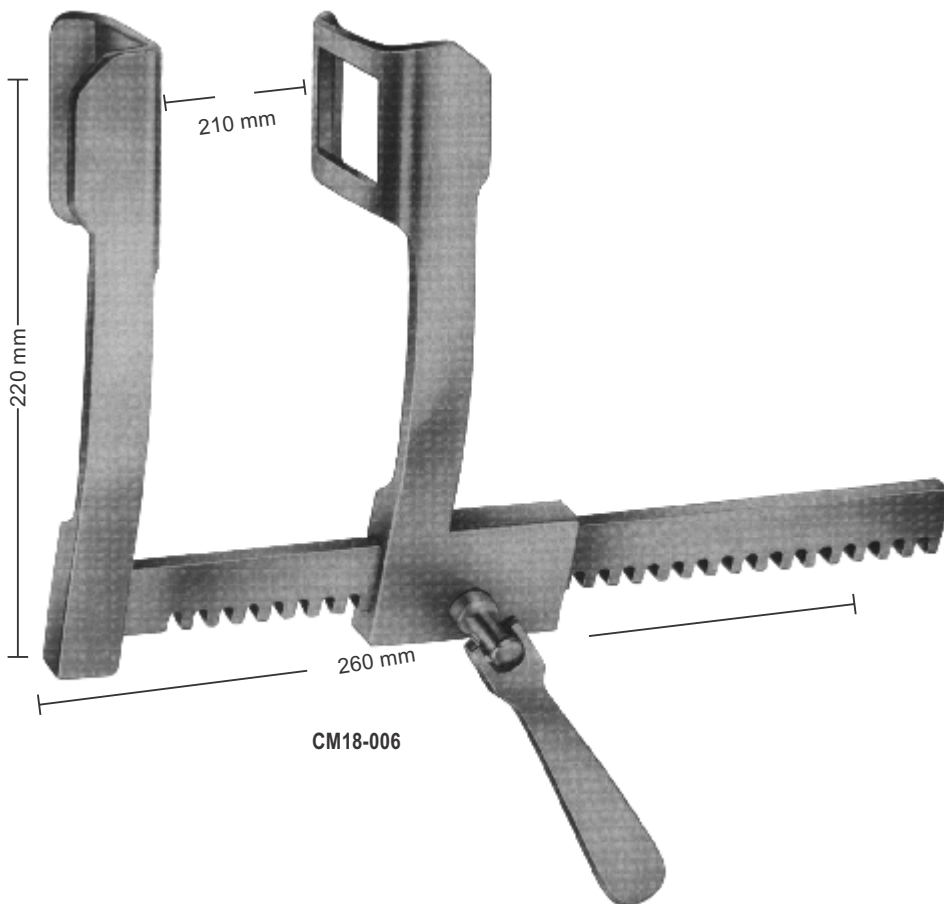
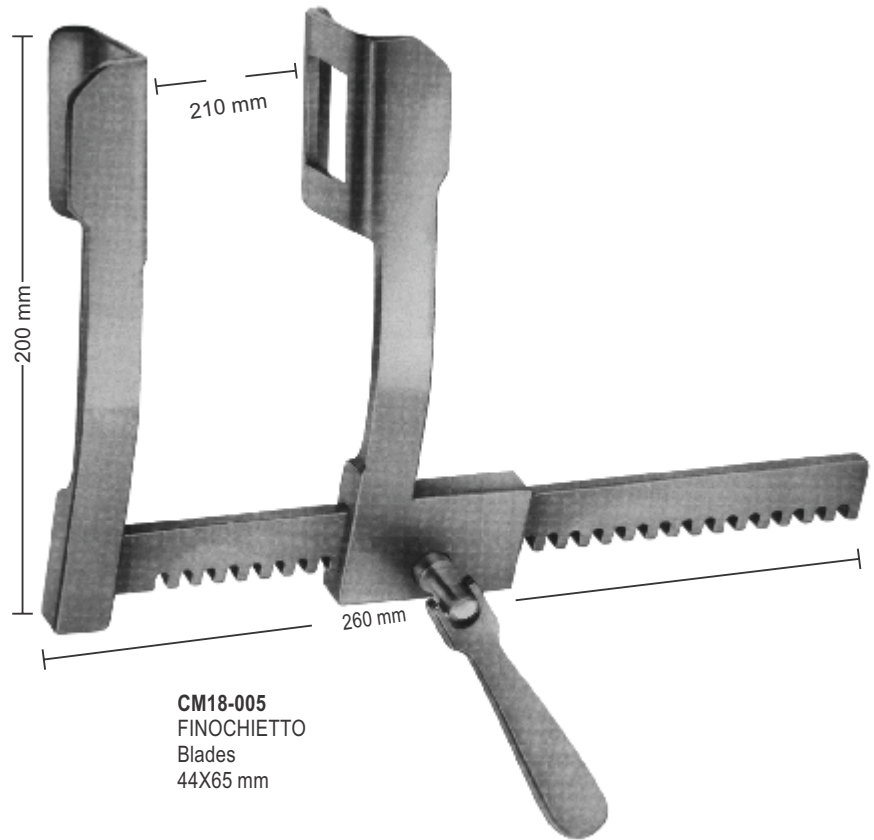

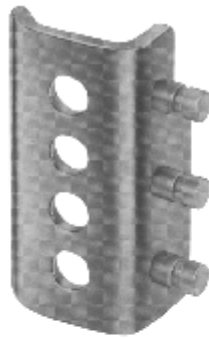

CM18-007
Blades
46x67 mm

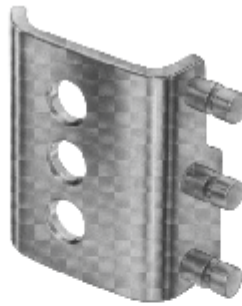

CM18-008
Blades
80x67 mm

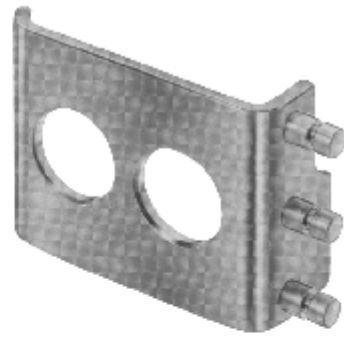

CM18-009
Blades
46x67 mm

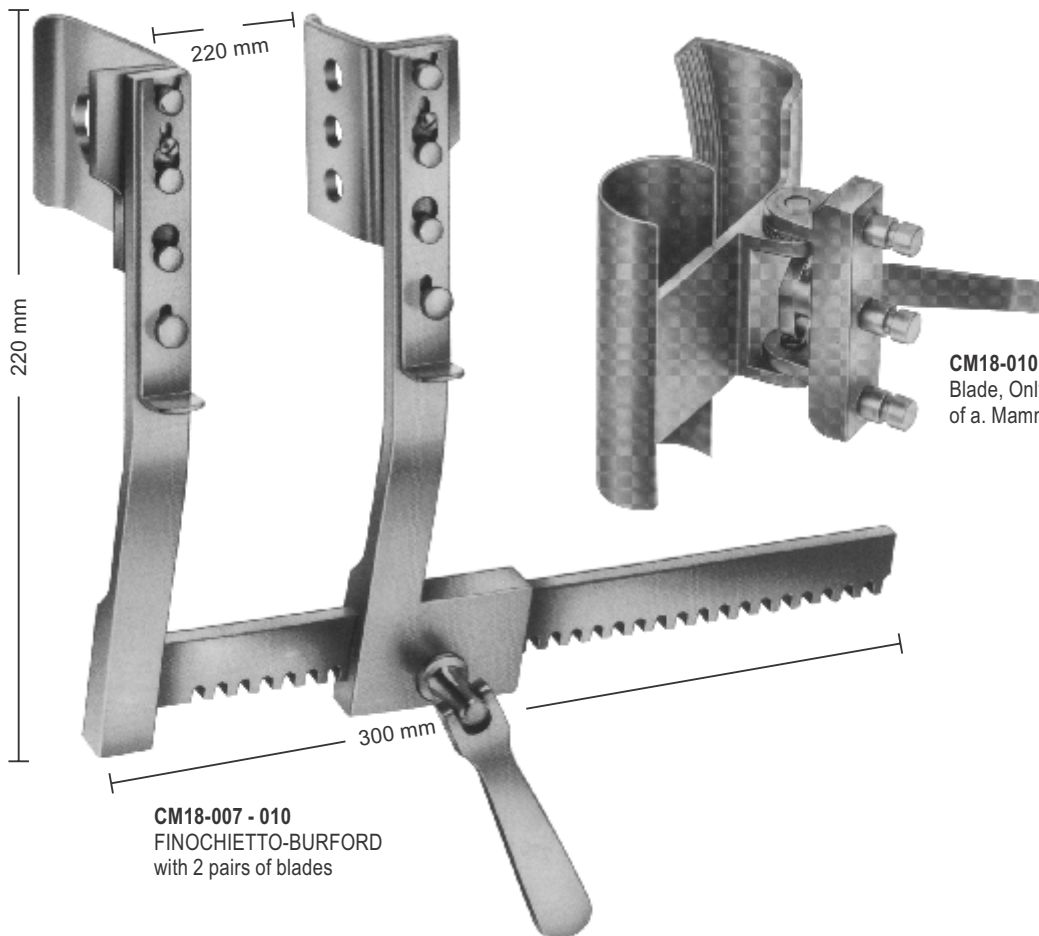
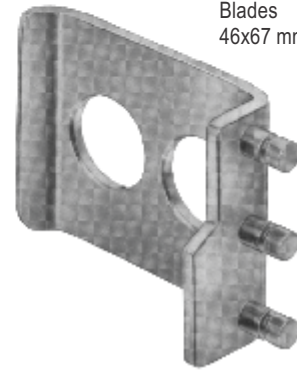
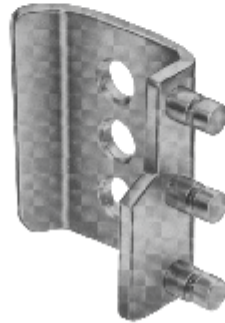
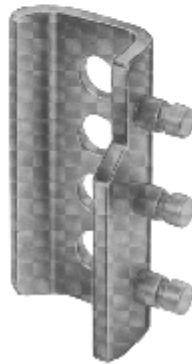

CM18-007 - 010
FINOCHIETTO-BURFORD
with 2 pairs of blades

CM18-010
Blade, Only, for preparation
of a. Mammaria, 25.5x80mm

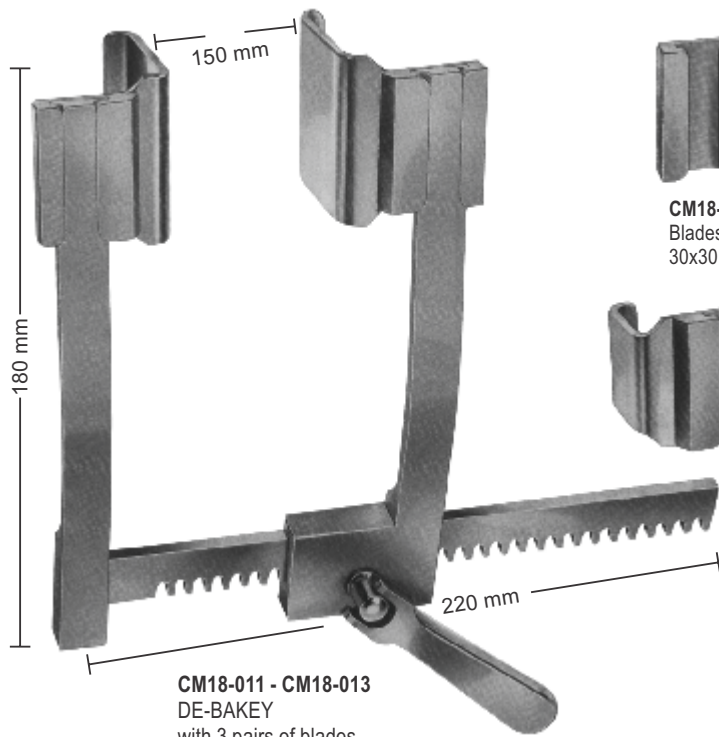

CM18-011 - CM18-013
DE-BAKEY
with 3 pairs of blades



CM18-011
Blades
30x30 mm



CM18-012
Blades
40x40 mm



CM18-013
Blades
50x50 mm

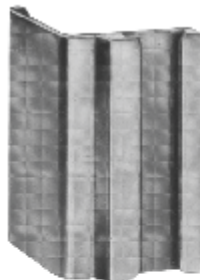

CM18-014
Blades
50x80 mm

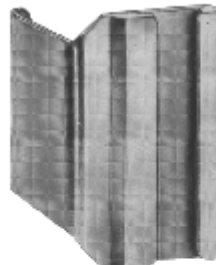

CM18-015
Blades
80x60 mm



CM18-016
Blades
50x80 mm

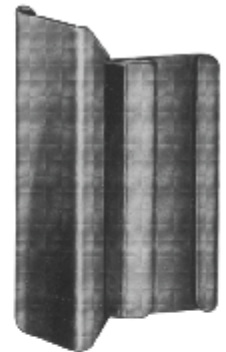

CM18-017
Blades
40x100 mm

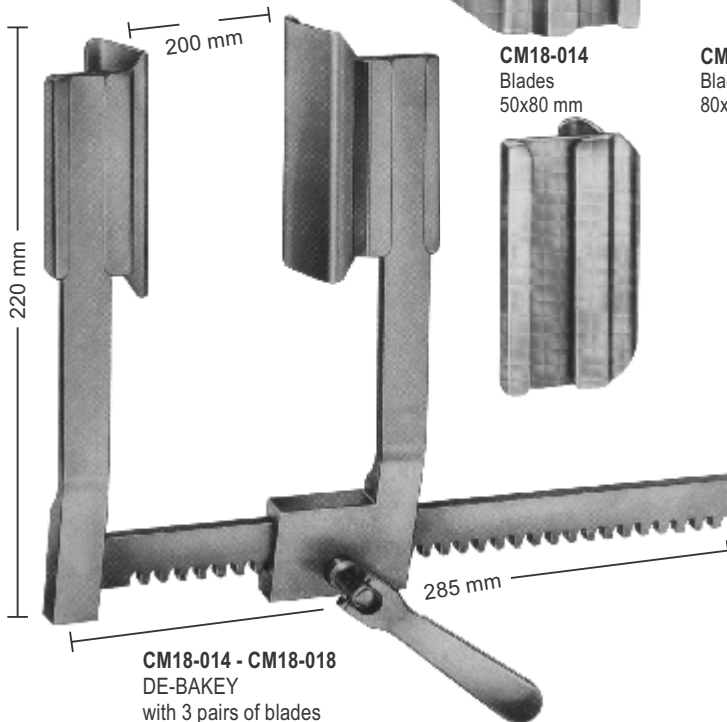

CM18-014 - CM18-018
DE-BAKEY
with 3 pairs of blades

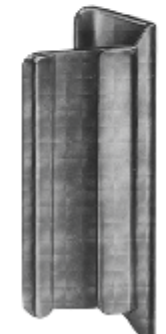
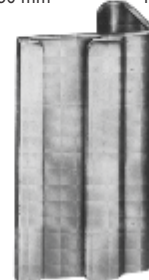

CM18-018
Sternotomy Blades
50x660 mm

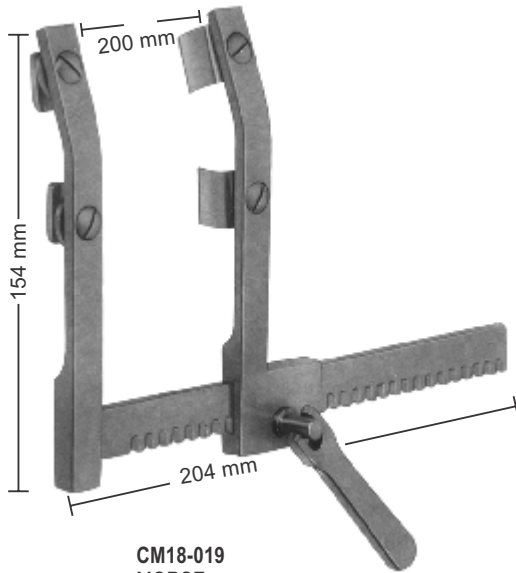

CM18-019
MORSE
Sternotomy spreader
for children, with moveable
double, each blade
12x20 mm

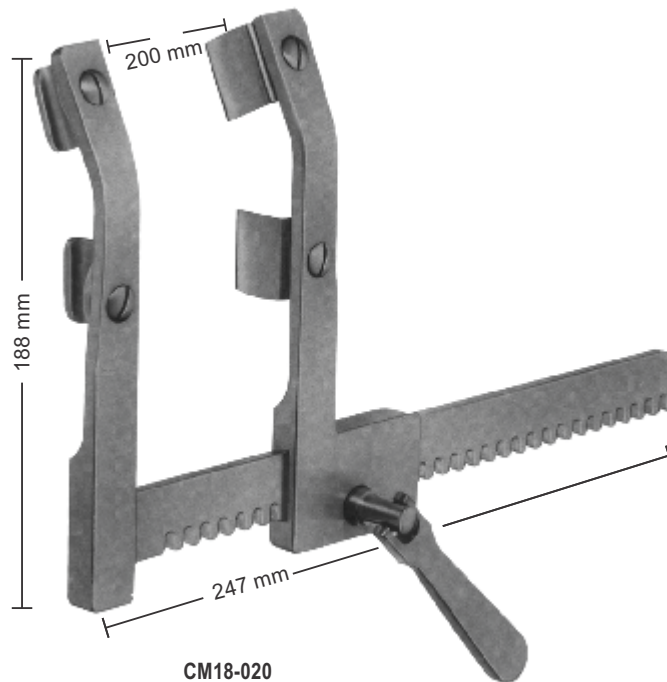

CM18-020
MORSE
Sternotomy spreader
for adults, with moveable
double, each blade
19x19 mm

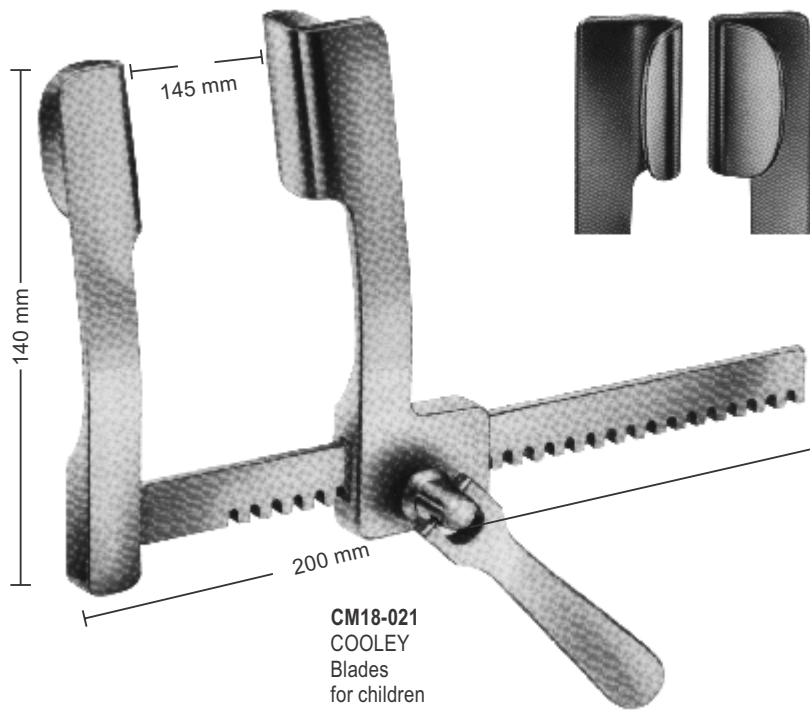

CM18-021
COOLEY
Blades
for children
21x45mm

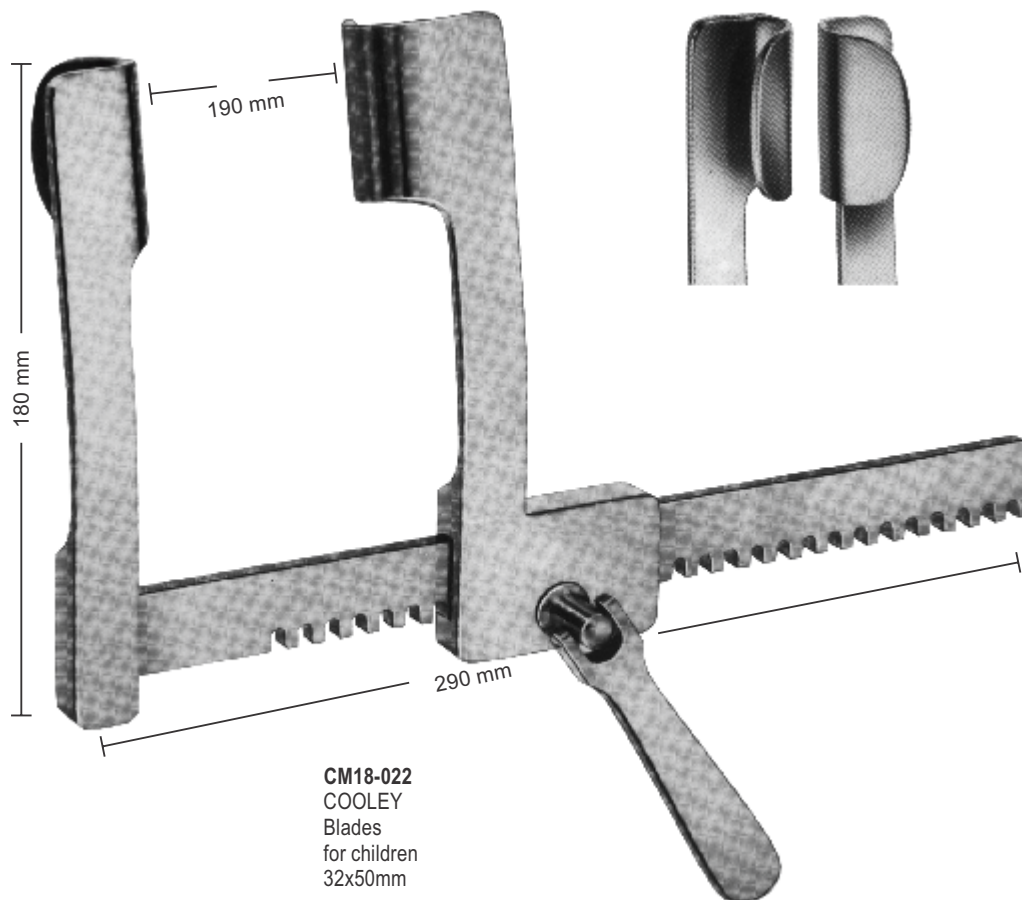

CM18-022
COOLEY
Blades
for children
32x50mm

STAINLESS STEEL

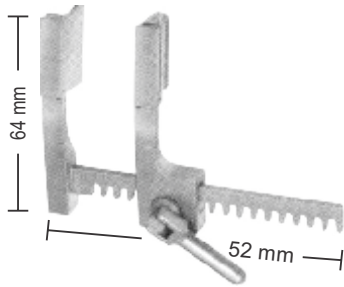

CM18-023 - CM18-024
for blades, with 2 pairs of blades
9X20 mm 9X10 mm, spreading 52 mm



CM18-023
Blades, only
9x20 mm



CM18-024
Blades, only
9x10 mm

ALUMINIUM

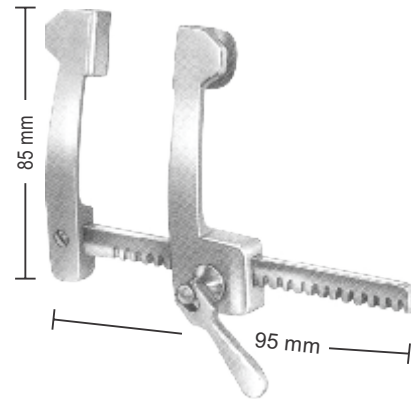

COOLEY
CM18-025
for blades, lateral blades 12X16 mm,
spreading 95 mm

ALUMINIUM

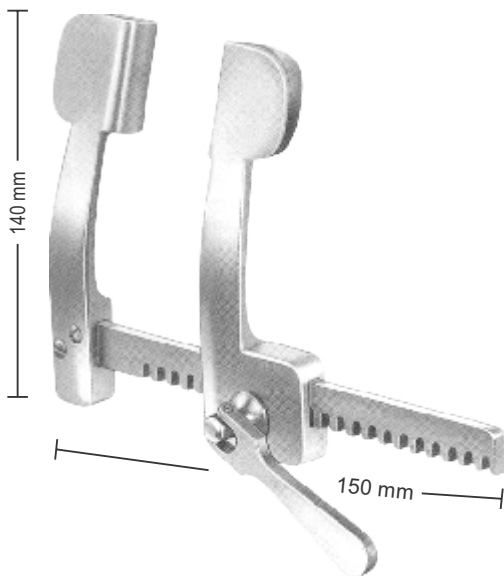

COOLEY
CM18-026
for children, lateral blades 21X44 mm,
spreading 150 mm

ALUMINIUM

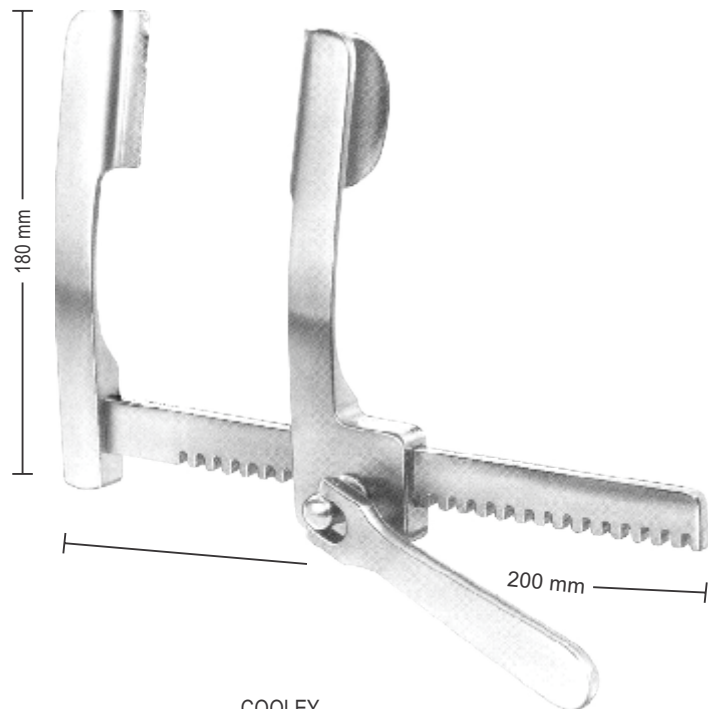

COOLEY
CM18-027
for adults, lateral blades 35X50 mm,
spreading 200 mm

ALUMINIUM

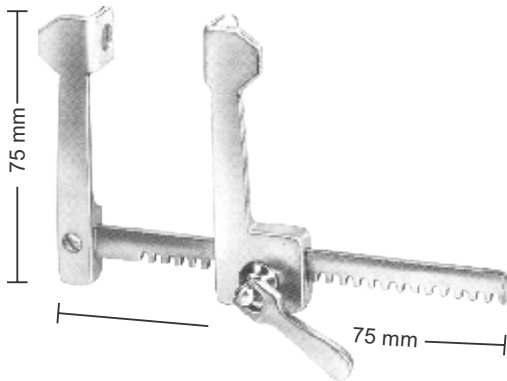

FINOCHIETTO, INFANT
CM18-028
for children, lateral blades 15X15 mm,
spreading 75 mm

STAINLESS STEEL

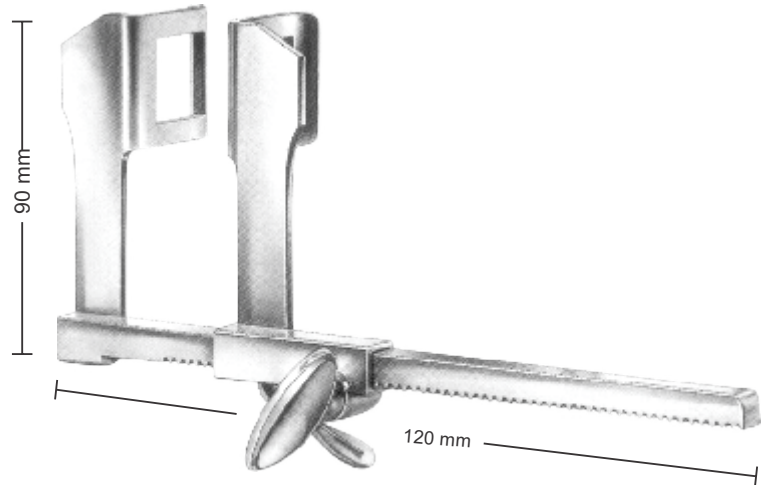

HAIGHT
CM18-029
lateral blades 30X30 mm,
spreading 120 mm

ALUMINIUM

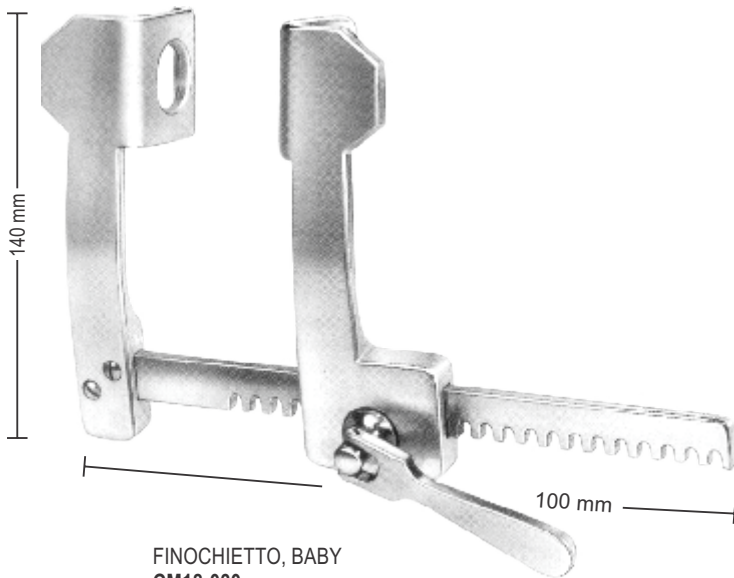

FINOCHIETTO, BABY
CM18-030
for children, lateral blades 31X31 mm,
spreading 100 mm

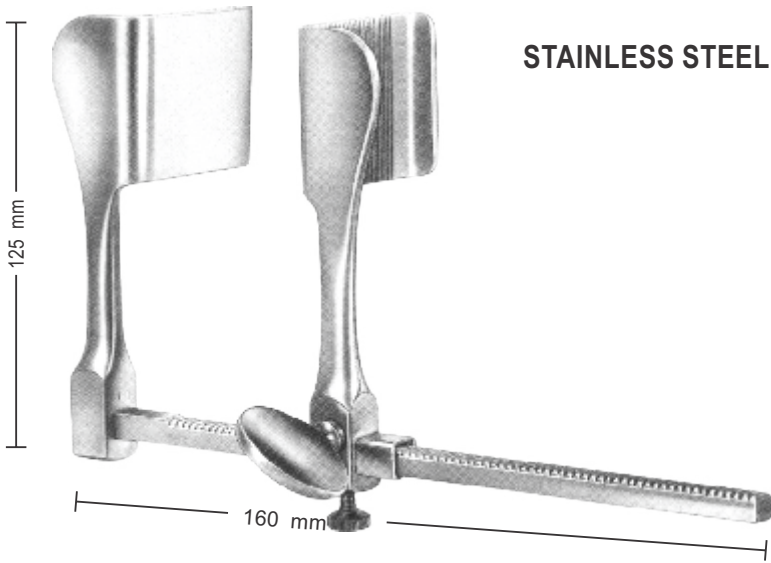

STAINLESS STEEL

TUFFIER
CM18-031
lateral blades 45X45 mm,
spreading 160 mm

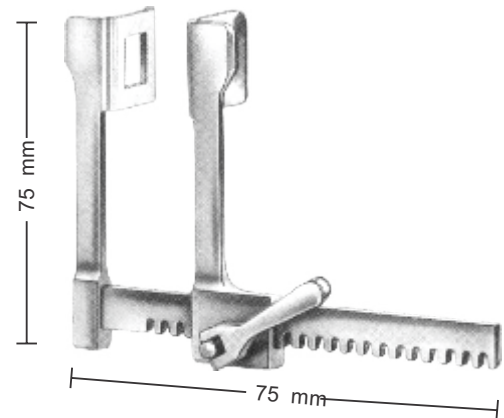

STAINLESS STEEL

FINOCHIETTO, BABY
CM18-032
lateral blades 14X15 mm,
spreading 75 mm



STAINLESS STEEL

FINOCHIETTO
CM18-033
lateral blades 30X45 mm, 46X62 mm, 80X65 mm,
spreading 150 mm, 190 mm, 190 mm

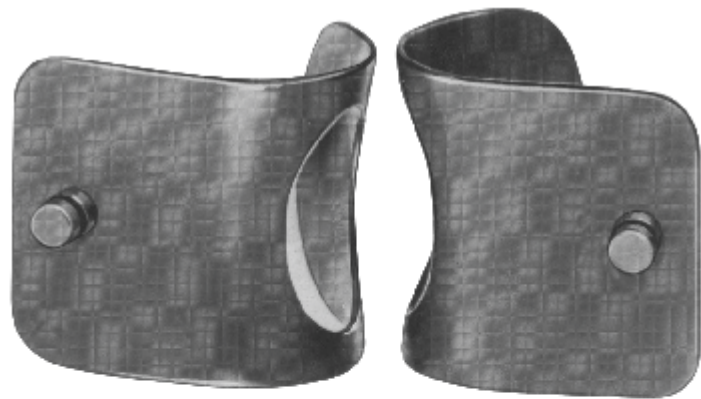

CM18-035
Blades
75x75 mm

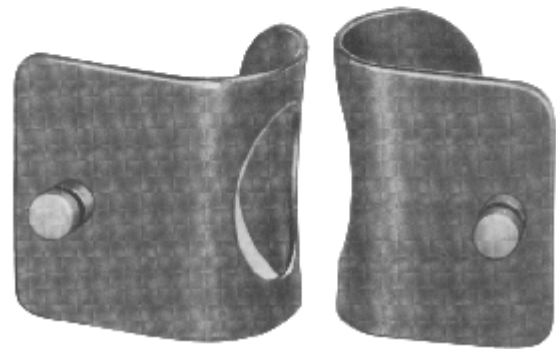

CM18-036
Blades
42x65 mm

Blades with Ball Snap System
Delivery: in Pairs

- CM18-034 - CM18-036**
Thoraxsperrer (Mercedes-Sperrer)
complete consisting of:
CM18-034 Retractor only
CM18-035 1 Pair of blades 42x65 mm
CM18-036 1 Pair of blades 75x75 mm

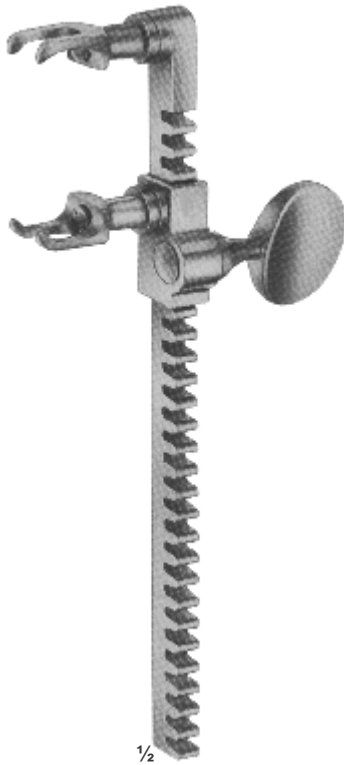

1/2
CM18-037
SELLORS
Rib spreader-and contractor
with swivel blades
200 mm



1/2
CM18-038
BAILEY
150 mm



CM18-039
for children

CM18-040
for children

1/2
CM18-039 - CM18-041
BAILEY
200 mm

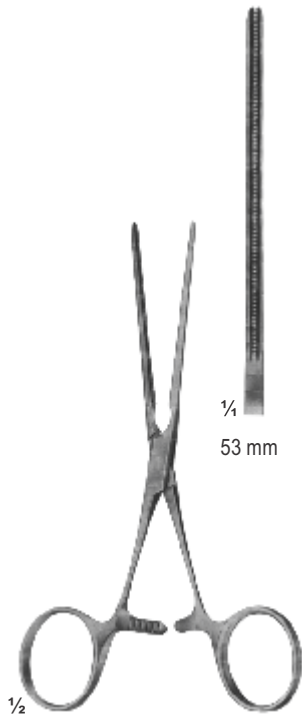

CM18-042
DE-BAKEY
gerade straight
130 mm

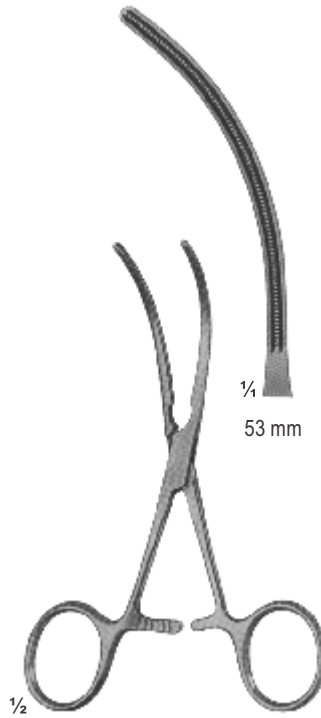

CM18-043
DE-BAKEY
Maul gebogen
curved jaws
125 mm

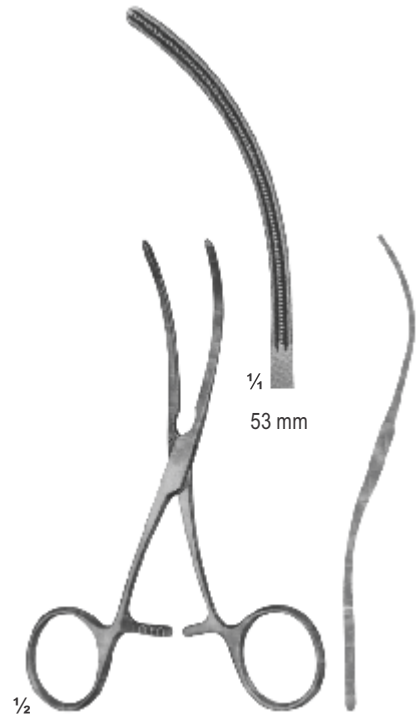

CM18-044
DE-BAKEY
S-shaped curved
125 mm

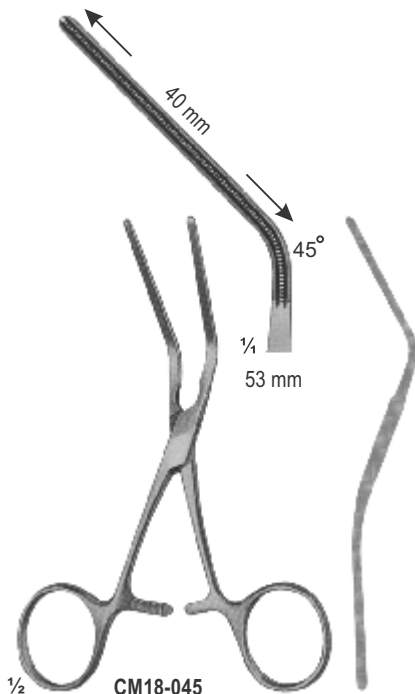

CM18-045
DE-BAKEY
45° winklig gebogen
angled 45°
125 mm

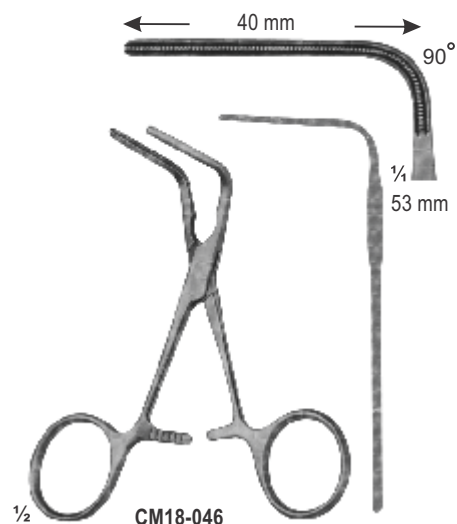

CM18-046
DE-BAKEY
90° winklig gebogen
angled 90°
105 mm



CM18-047 - CM18-050
CASTANESA

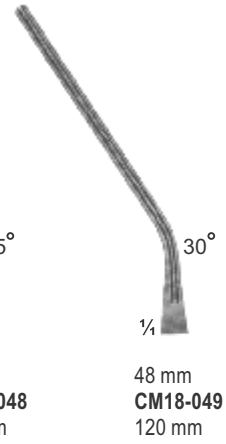
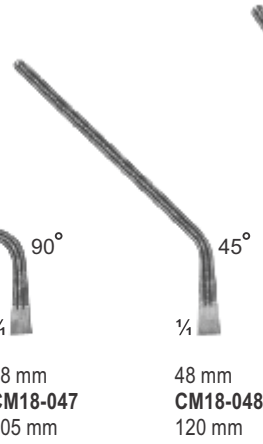
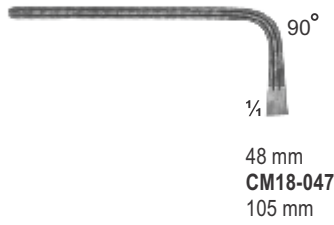

CM18-051 - CM18-054
CASTANESA

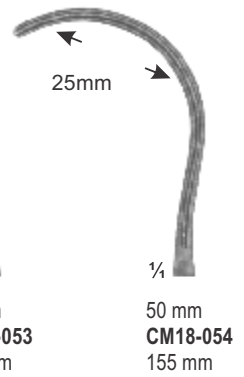
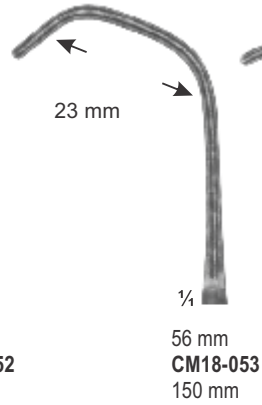
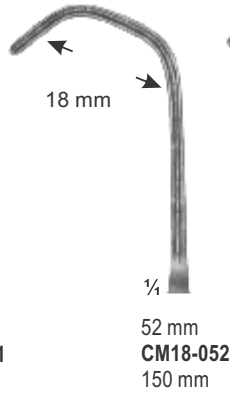
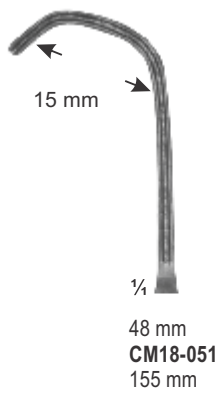

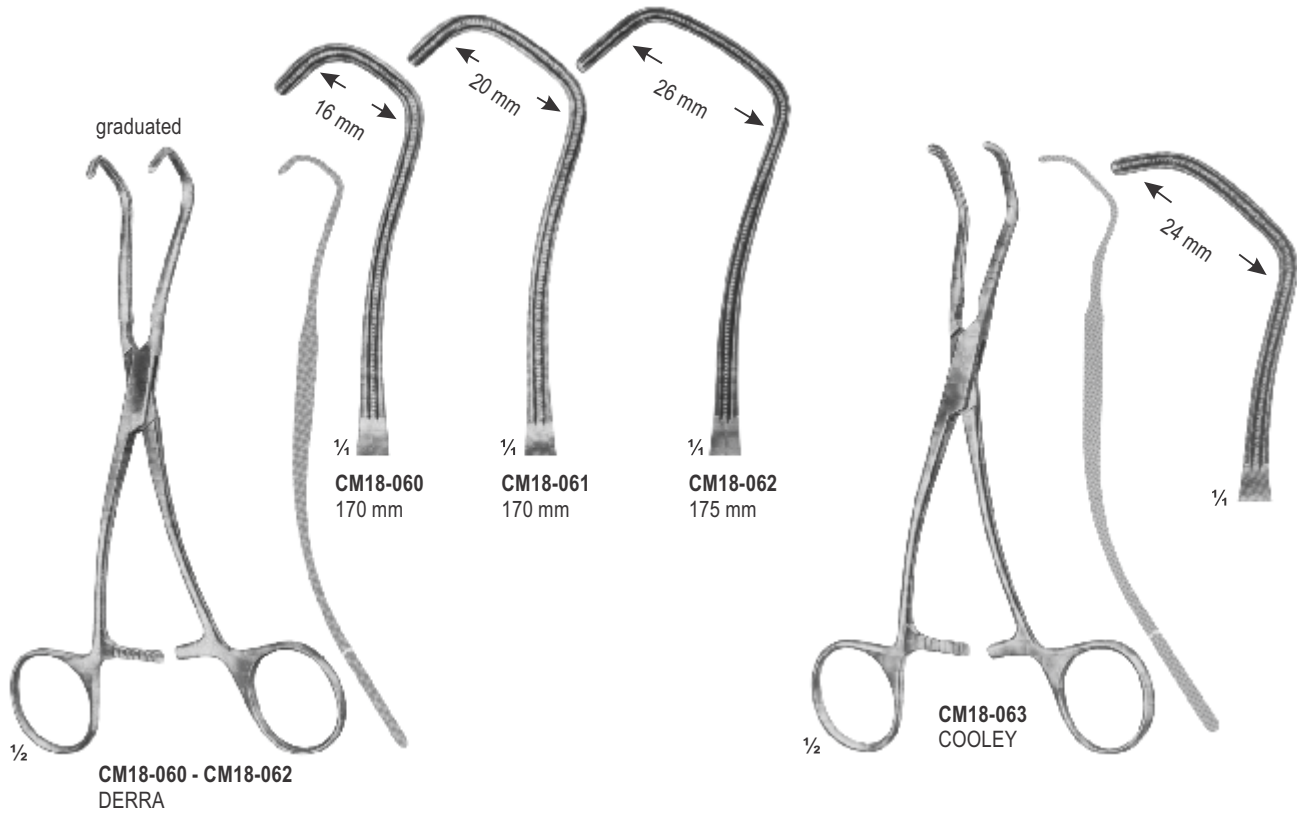
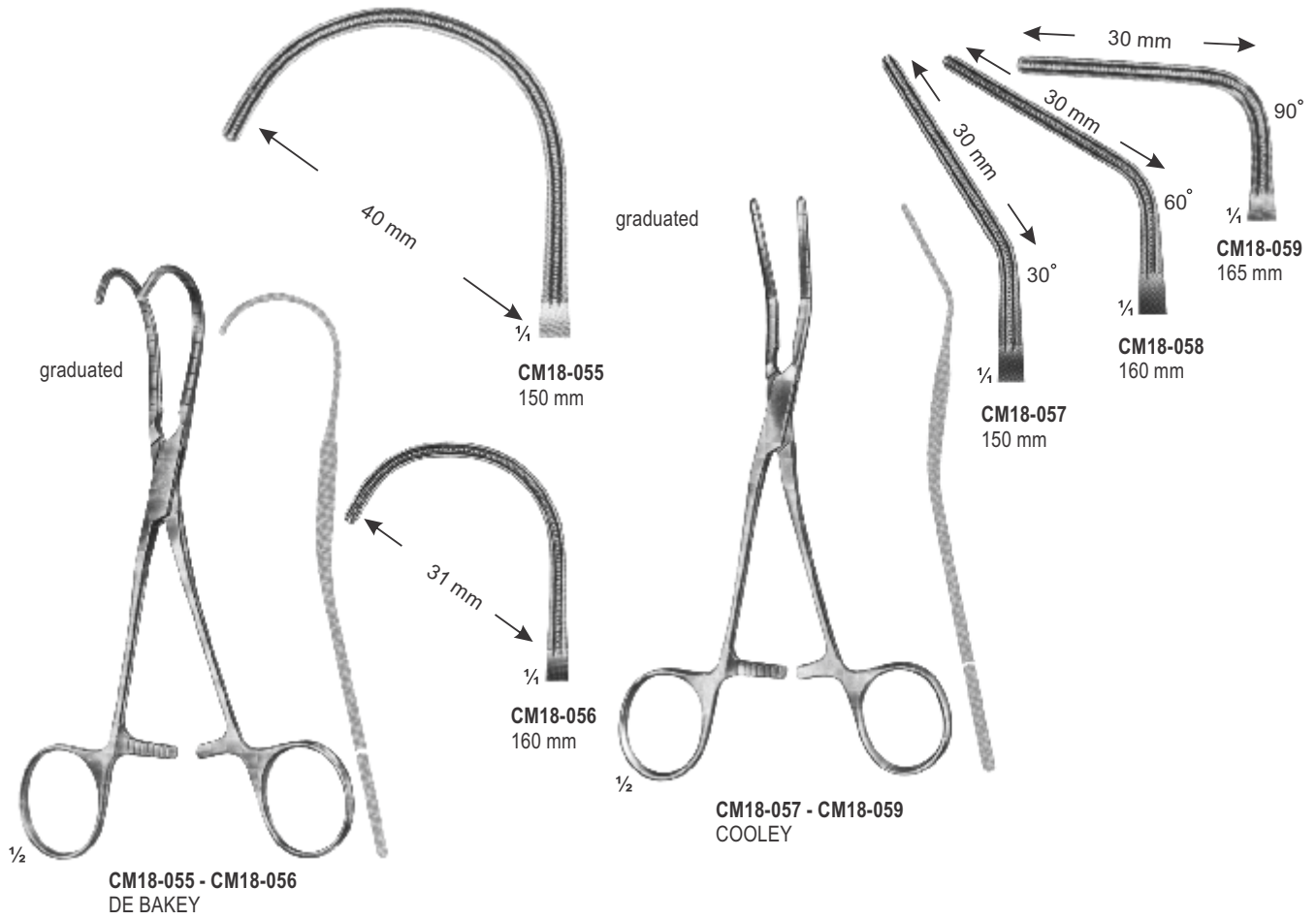

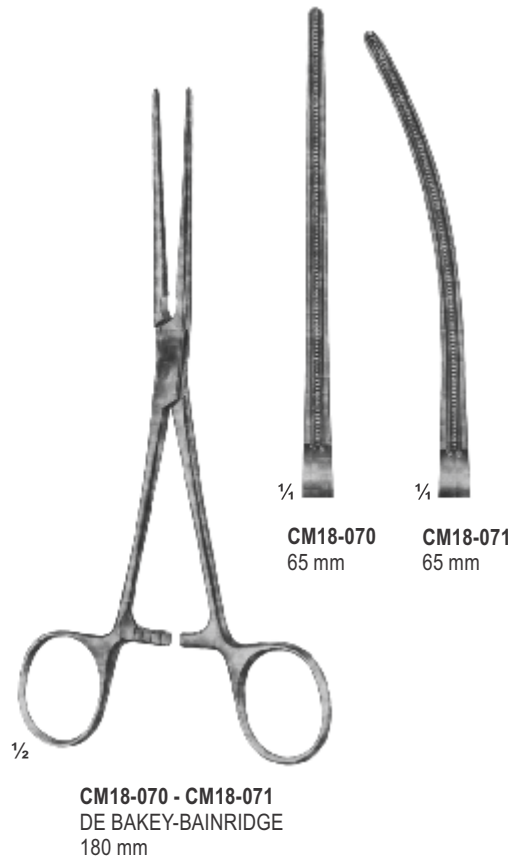
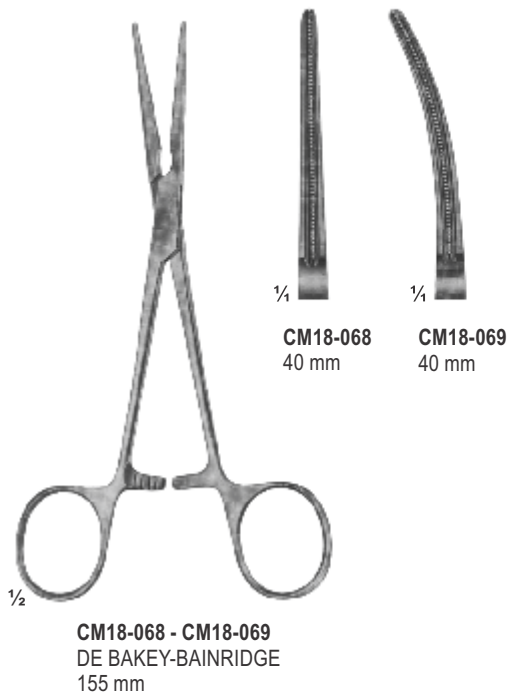
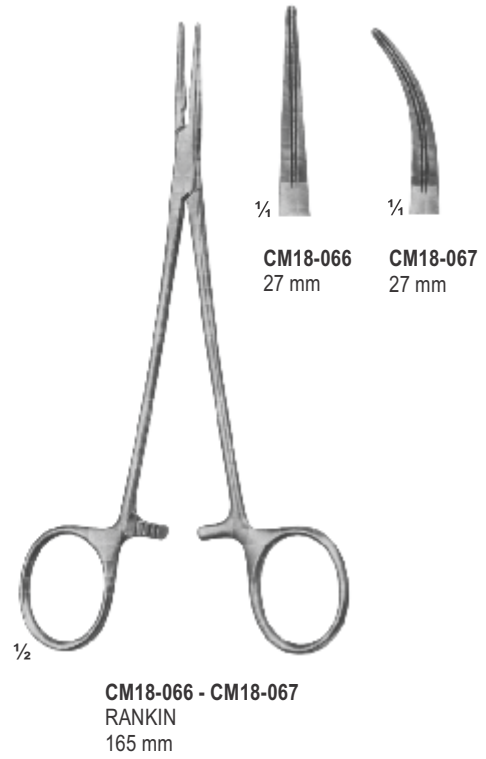
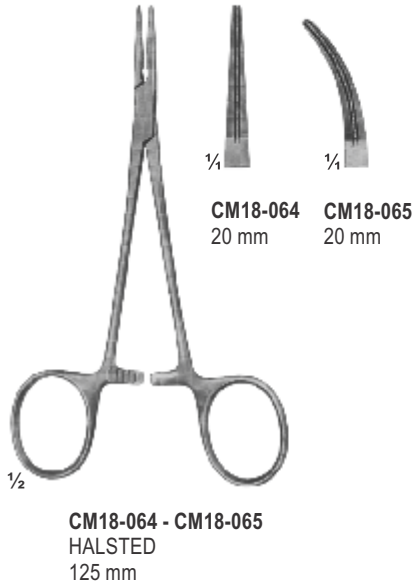

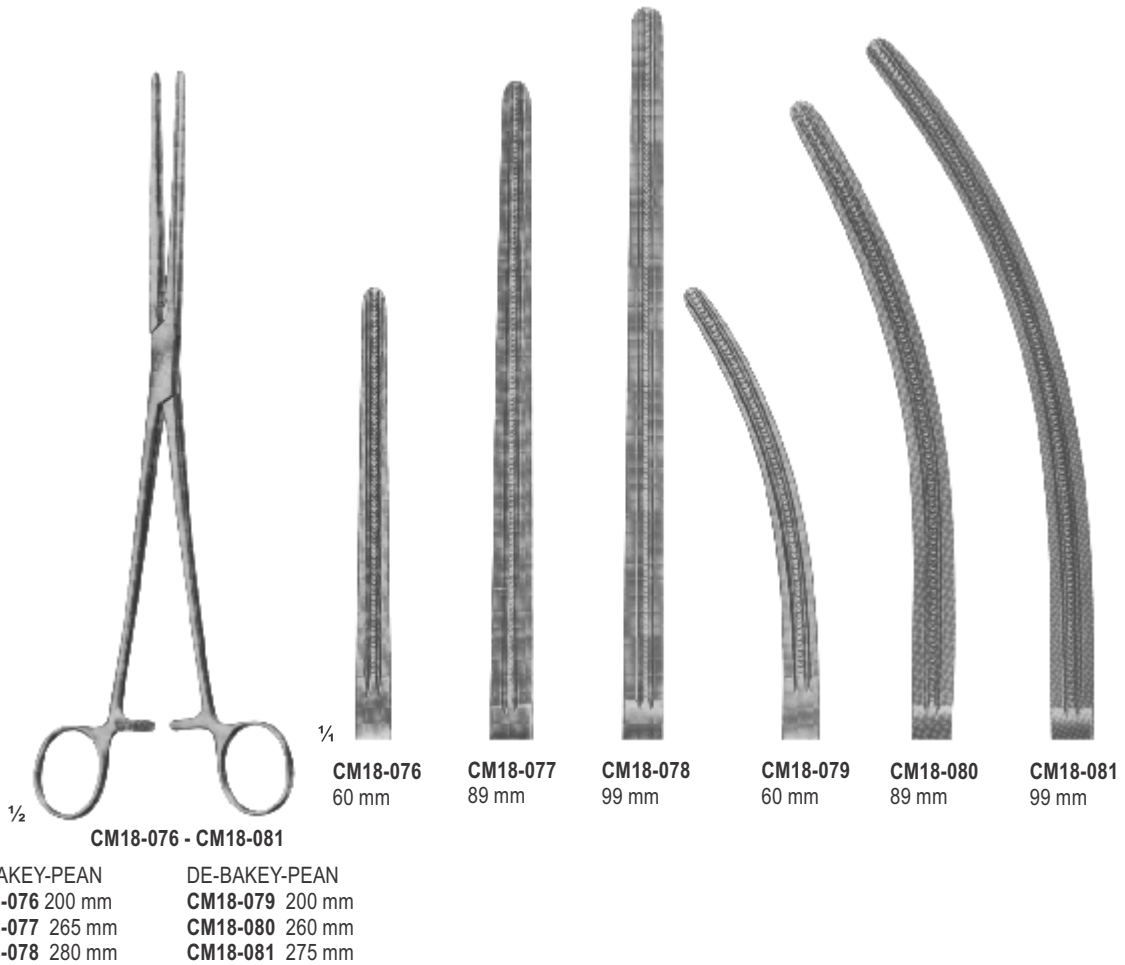
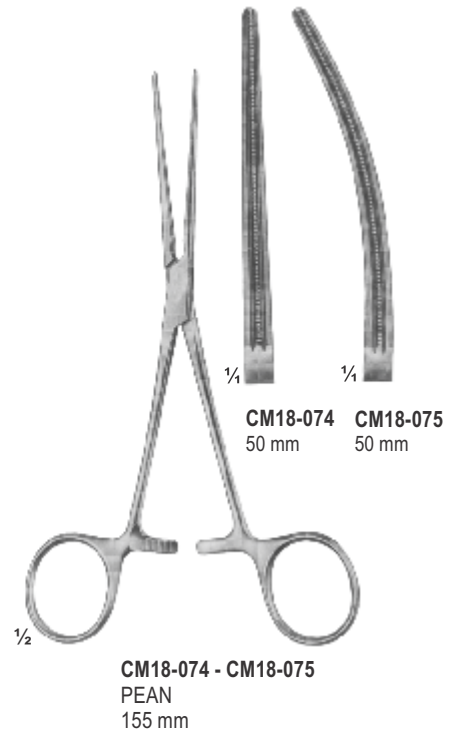
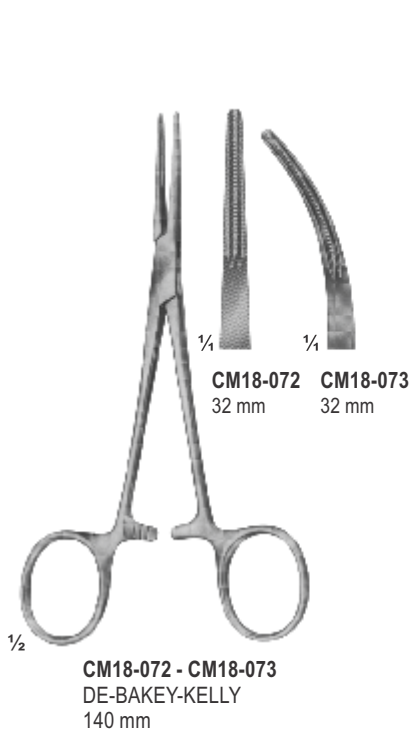

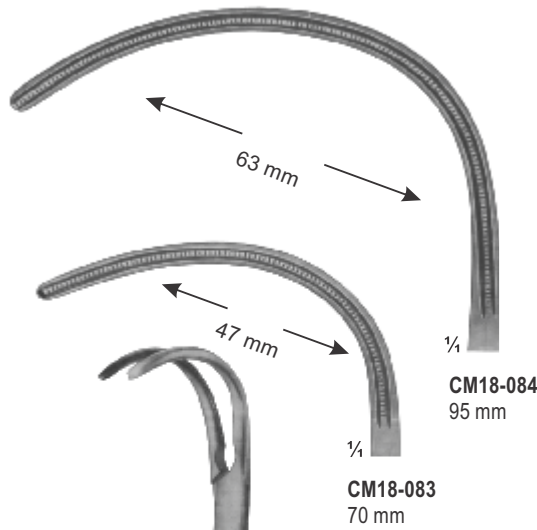
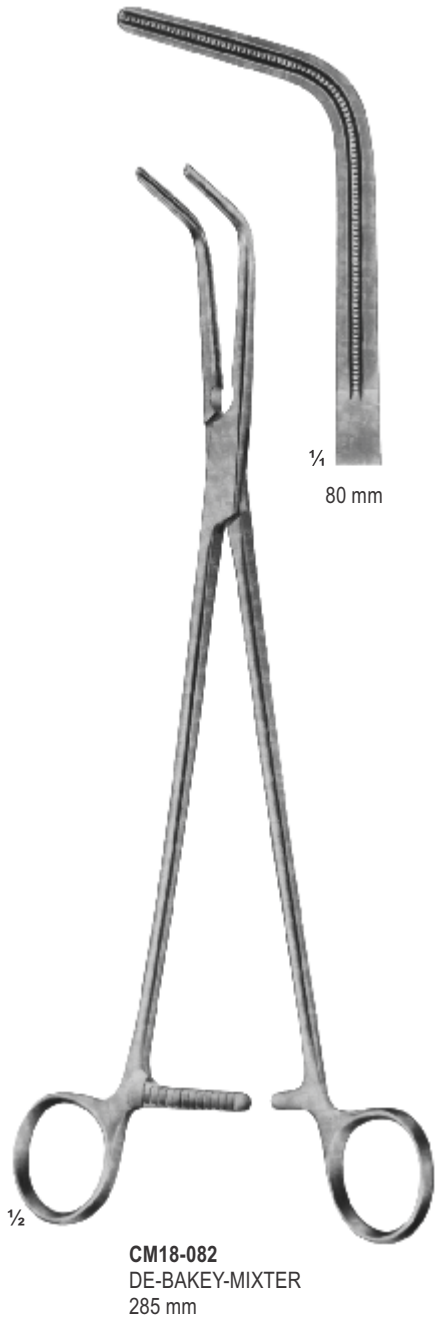

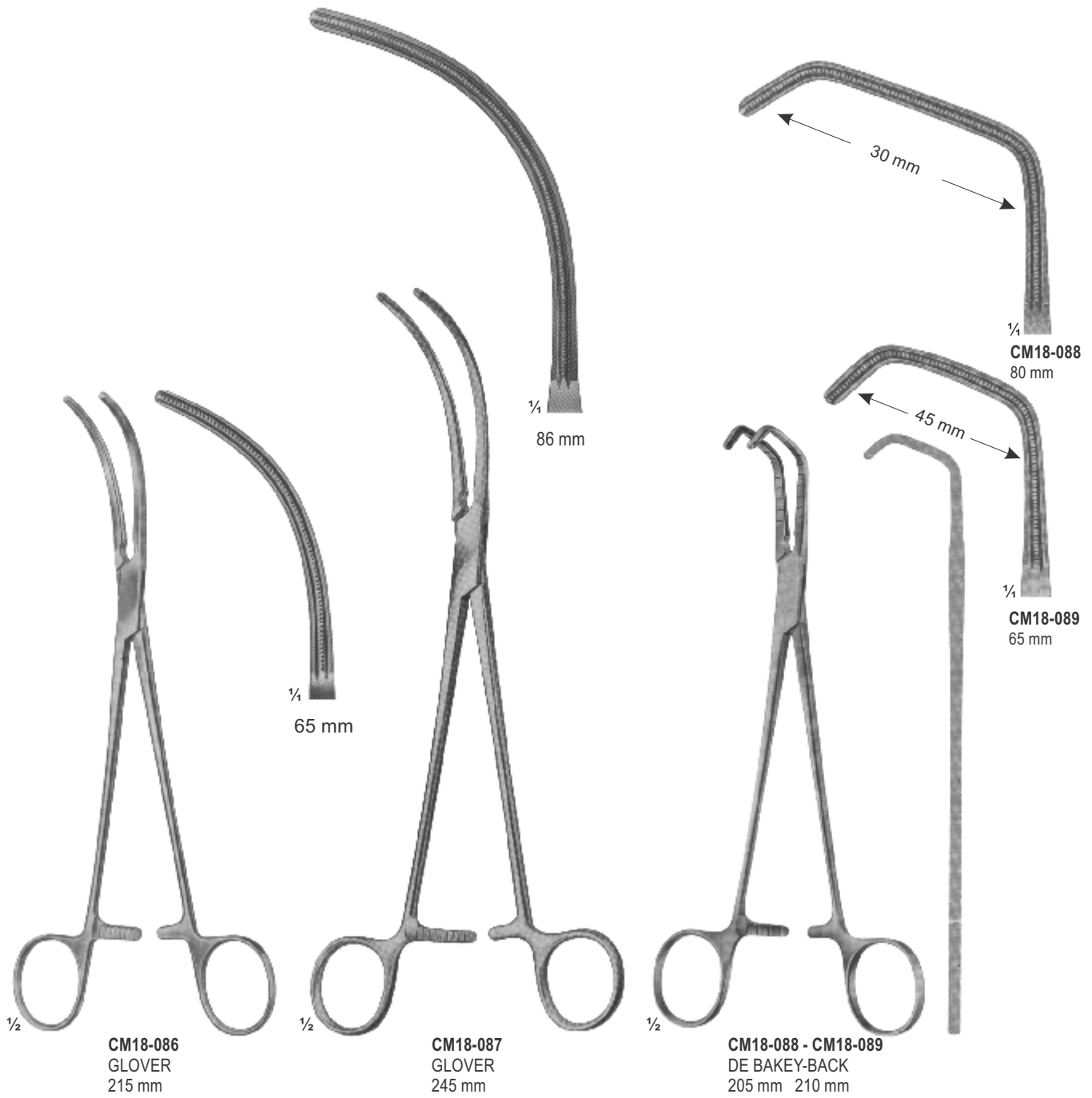



CM18-090 - CM18-093
DE BAKEY-HARKEN
CM18-090 - 255 mm
CM18-091 - 245 mm
CM18-092 - 245 mm
CM18-093 - 245 mm

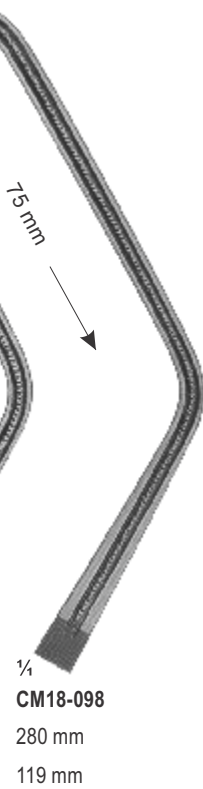
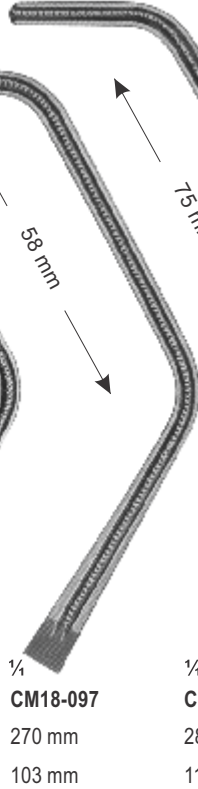
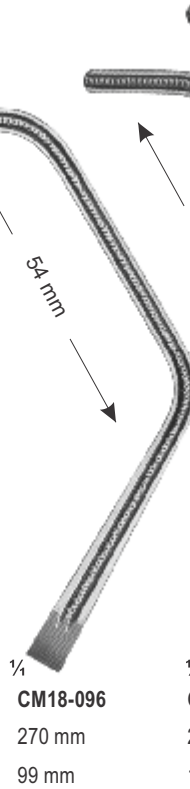
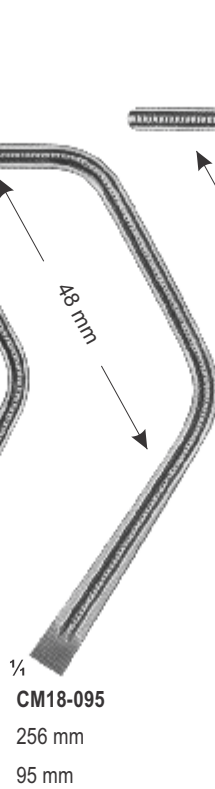
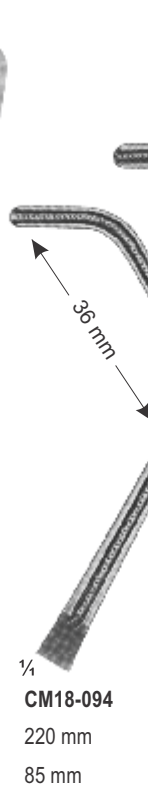
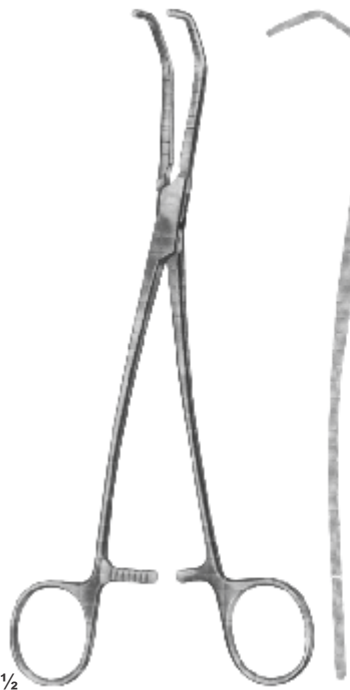

CM18-094 - CM18-098
DE BAKEY
Total Length: 220 mm
Length of jaws: 85 mm

CM18-094
220 mm
85 mm

CM18-095
256 mm
95 mm

CM18-096
270 mm
99 mm

CM18-097
270 mm
103 mm

CM18-098
280 mm
119 mm



1/2

DE-BAKEY-KELLY
CM18-099 - CM18-100
140 mm



1/4

CM18-099
32 mm



1/4

CM18-100
32 mm



1/2

PEAN
CM18-101 - CM18-102
155 mm



1/4

CM18-101
50 mm



1/4

CM18-102
50 mm



1/2

CM18-103 - CM18-108

DE-BAKEY-PEAN	DE-BAKEY-PEAN
CM18-103 200 mm	CM18-106 200 mm
CM18-104 265 mm	CM18-107 260 mm
CM18-105 280 mm	CM18-108 275 mm



1/4

CM18-103
60 mm



CM18-104
89 mm



CM18-105
99 mm



CM18-106
60 mm



CM18-107
89 mm



CM18-108
99 mm



CASTANEDA
CM18-109 - CM18-112

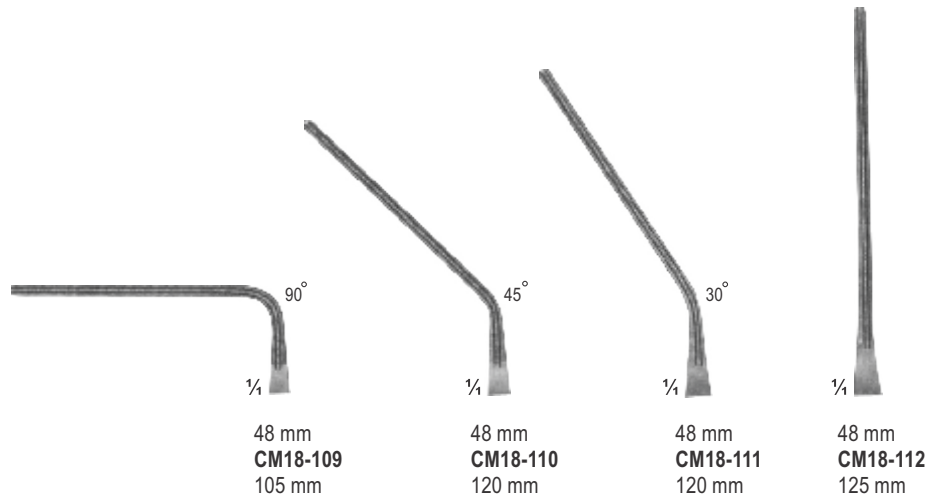

CASTANEDA
CM18-113 - CM18-116

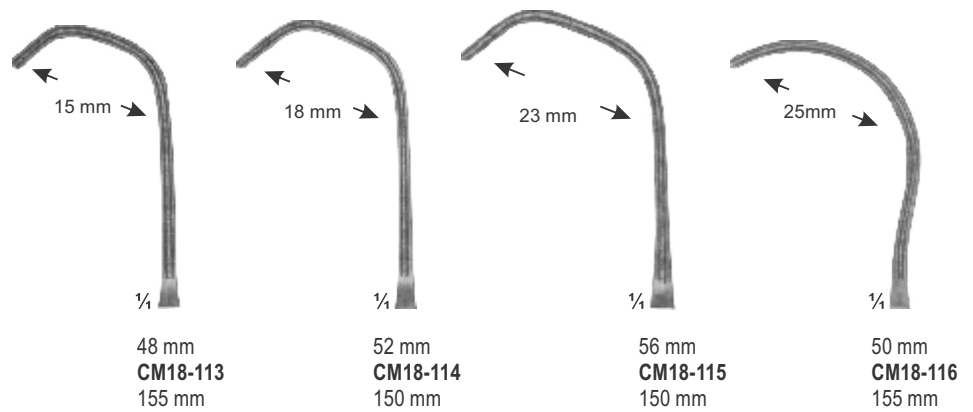

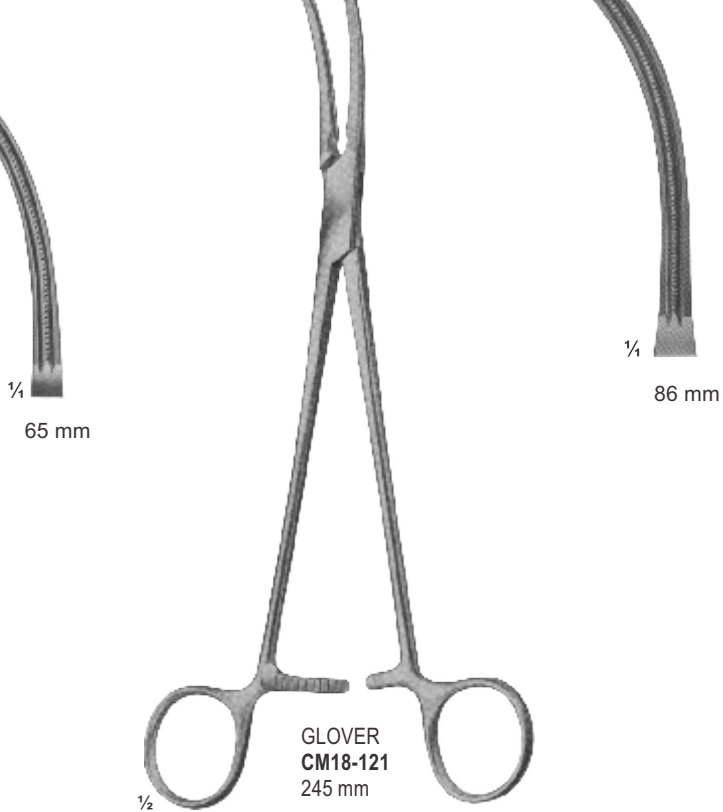
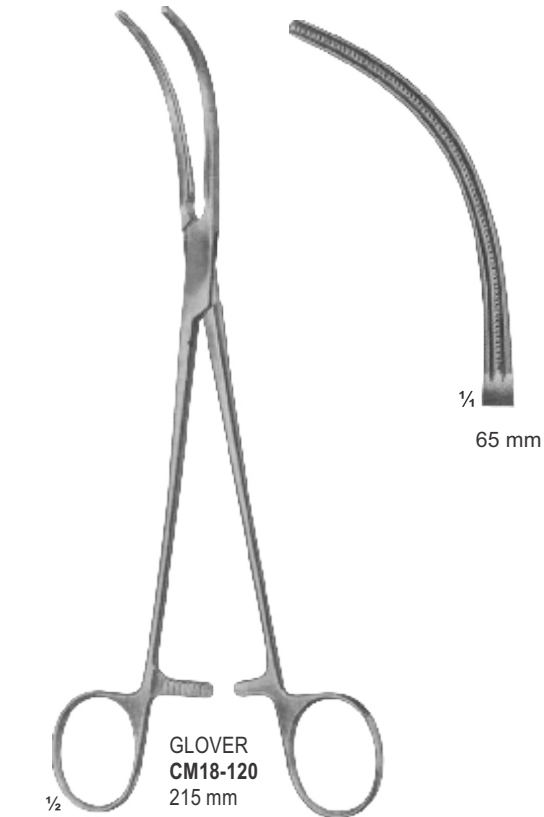
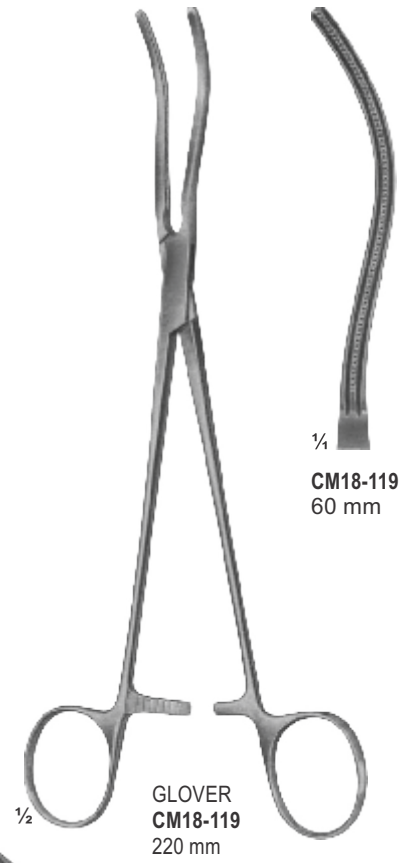
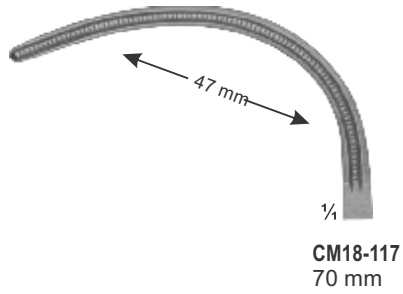
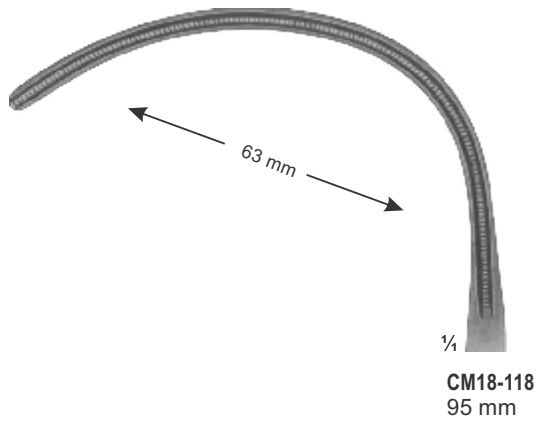



DE BAKEY-BACK
CM18-122 20.5 cm
CM18-123 21 cm

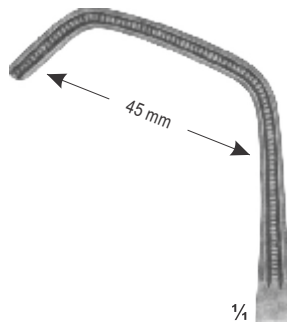

$\frac{1}{4}$
CM18-122
 65 mm

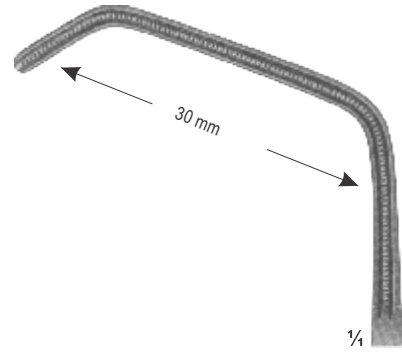

$\frac{1}{4}$
CM18-123
 80 mm



$\frac{1}{4}$
CM18-124
 86 mm



$\frac{1}{4}$
CM18-125
 86 mm



$\frac{1}{4}$
CM18-126
 86 mm

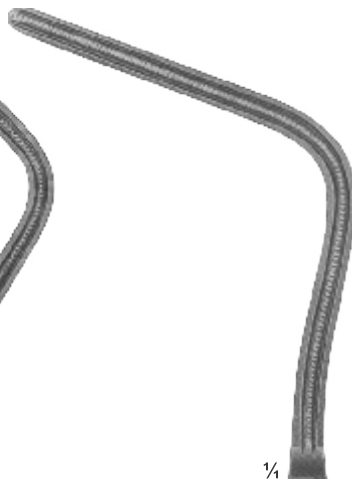

$\frac{1}{4}$
CM18-127
 86 mm



DE BAKEY-HARKEN
CM18-124 25.5 cm
CM18-125 24.5 cm
CM18-126 24.5 cm
CM18-127 24.5 cm

$\frac{1}{2}$

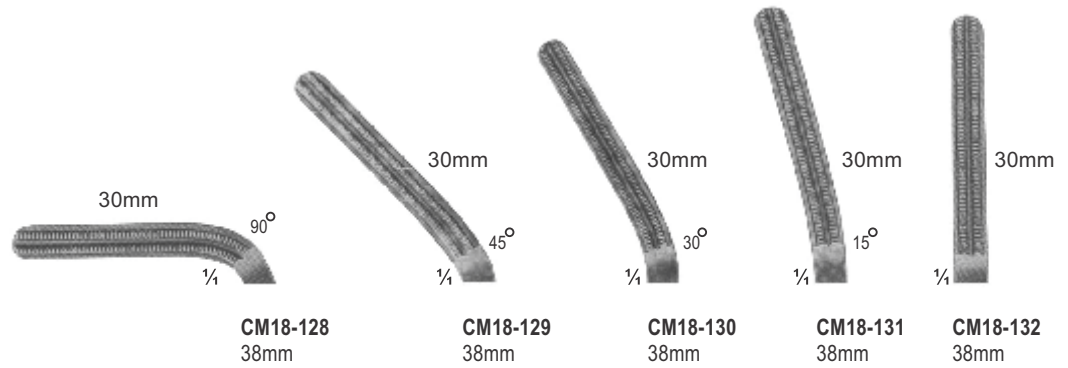

DARDIK

- CM18-128 15 cm
- CM18-129 15 cm
- CM18-130 15 cm
- CM18-131 14.5 cm
- CM18-132 13 cm

- CM18-133 17 cm
- CM18-134 17 cm
- CM18-135 17 cm
- CM18-136 16 cm
- CM18-137 13.5 cm

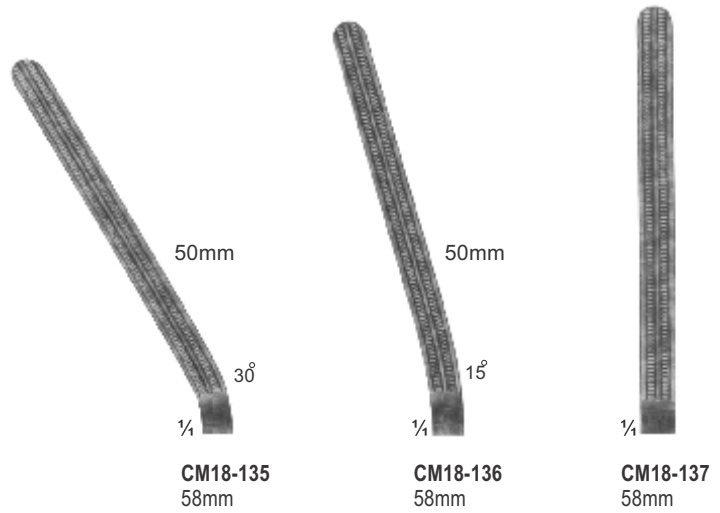
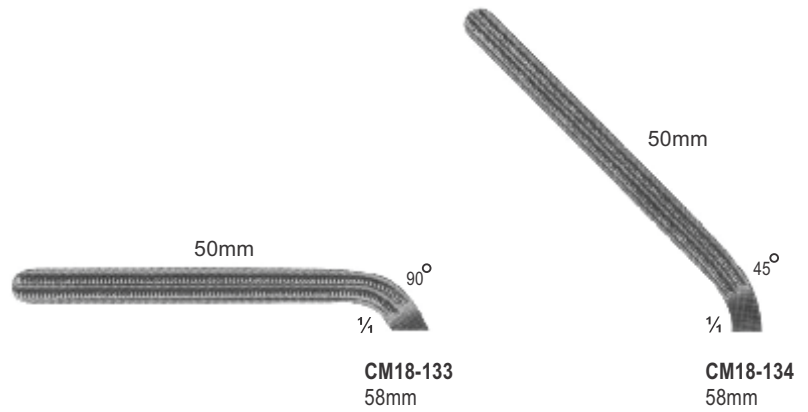

ATRAUMA

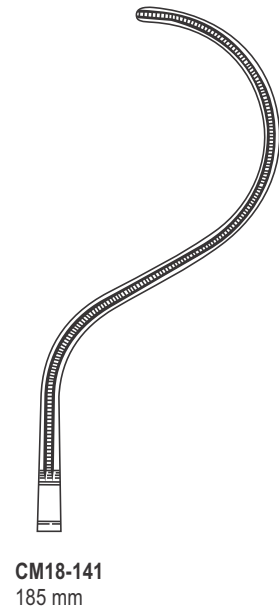
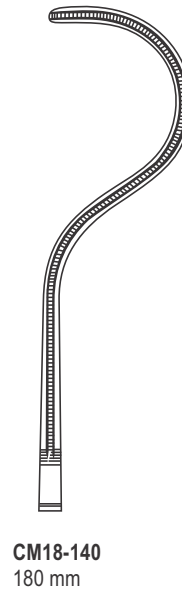
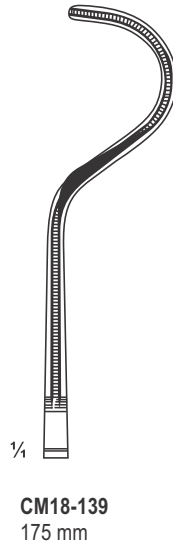
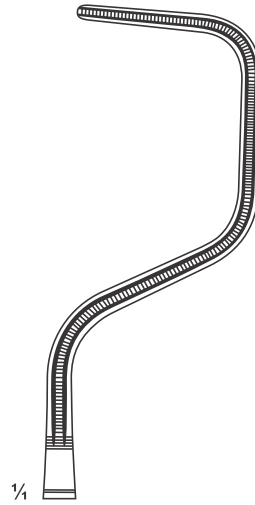
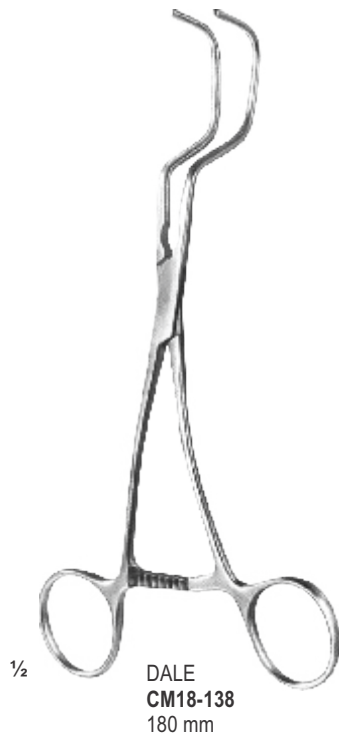

ATRAUMA

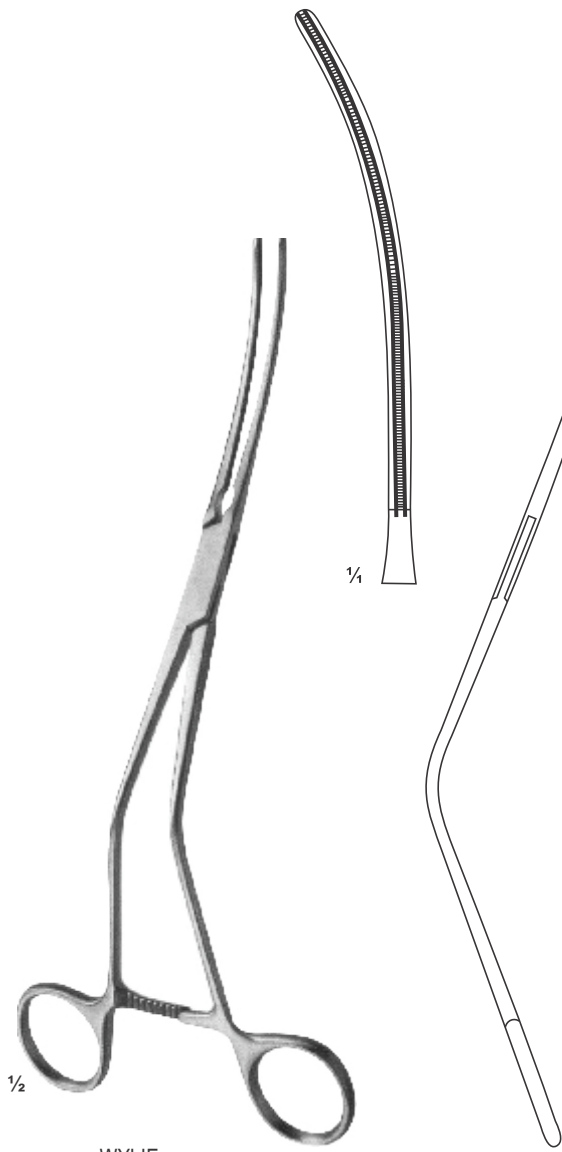

WYLIE
CM18-142
240 mm

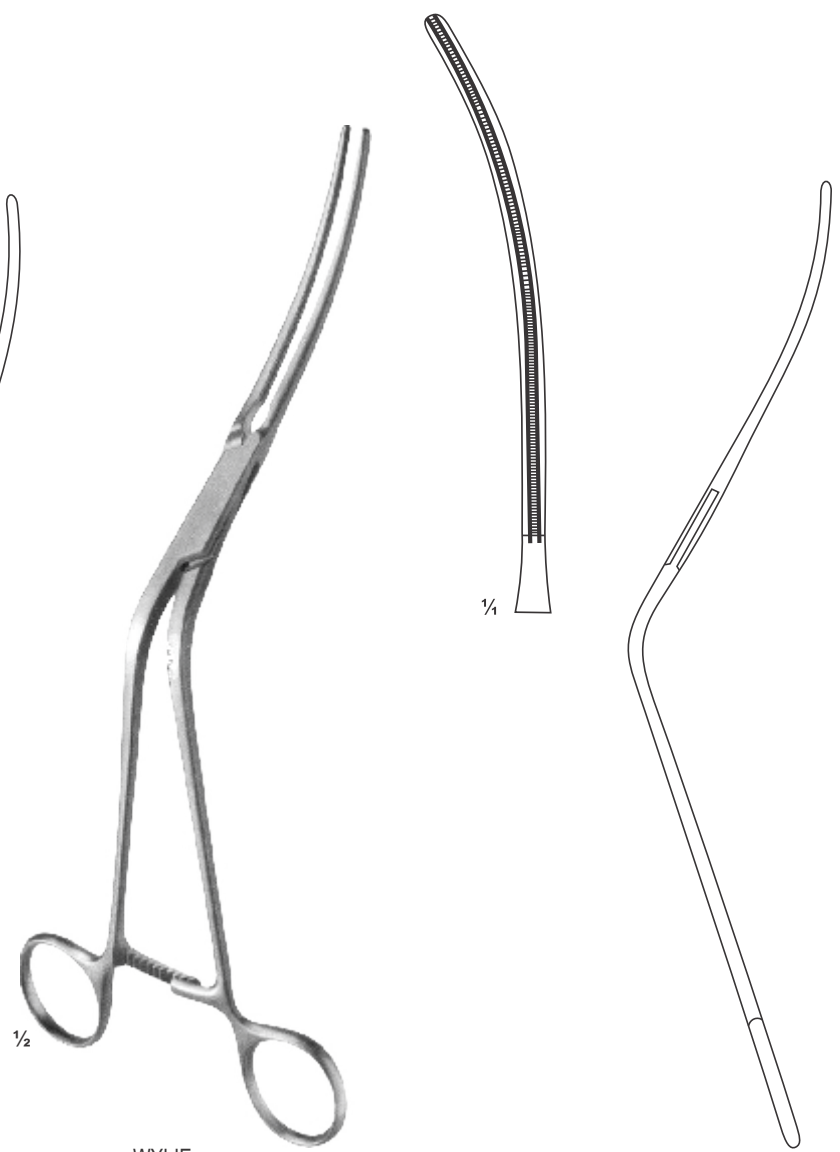

WYLIE
CM18-143
270 mm

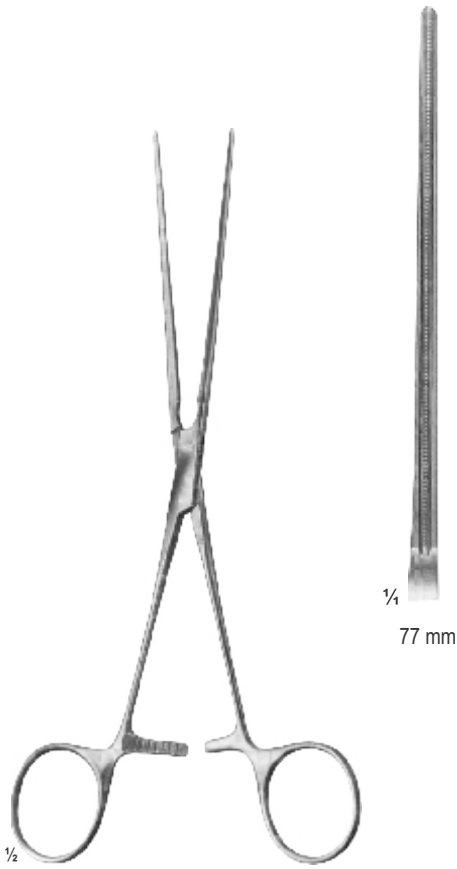

LELAND-JONES
CM18-144
195 mm

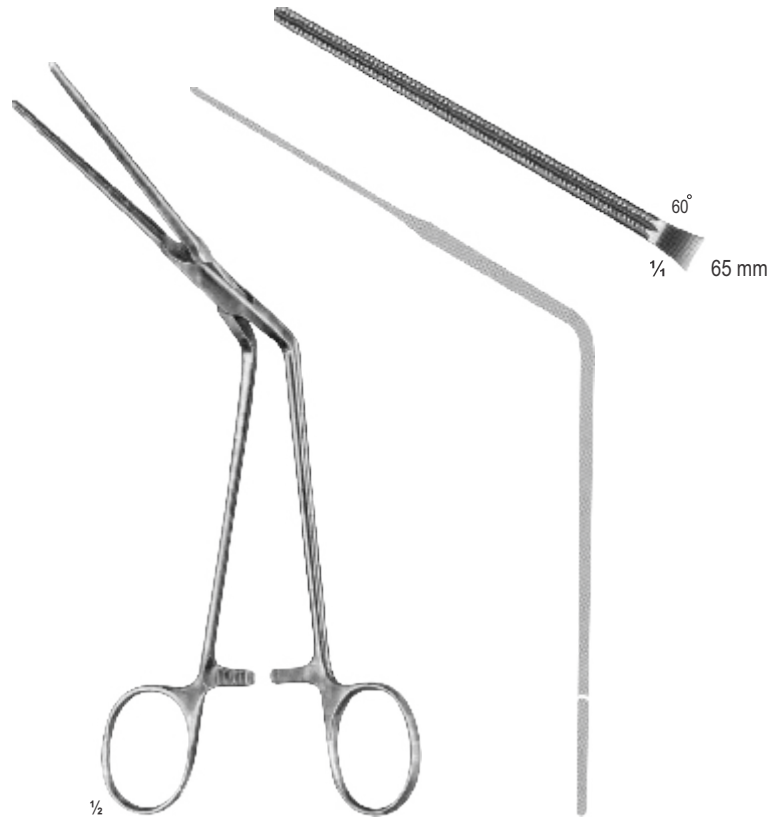

DE BAKEY
CM18-145
200 mm Liac Clamp

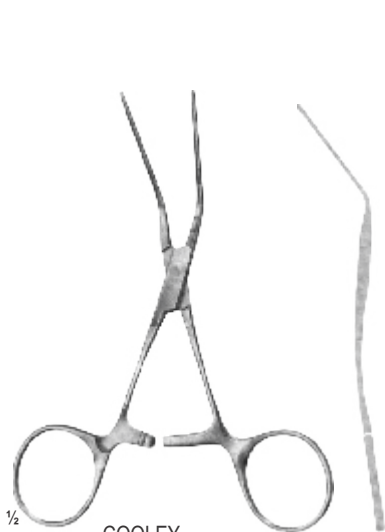

COOLEY
CM18-146 120 mm
CM18-147 125 mm
CM18-148 125 mm

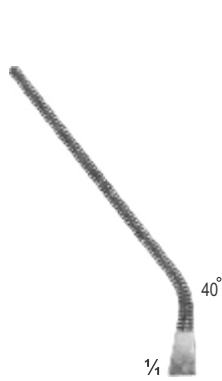

CM18-146
50 mm



CM18-147
50 mm



CM18-148
52 mm

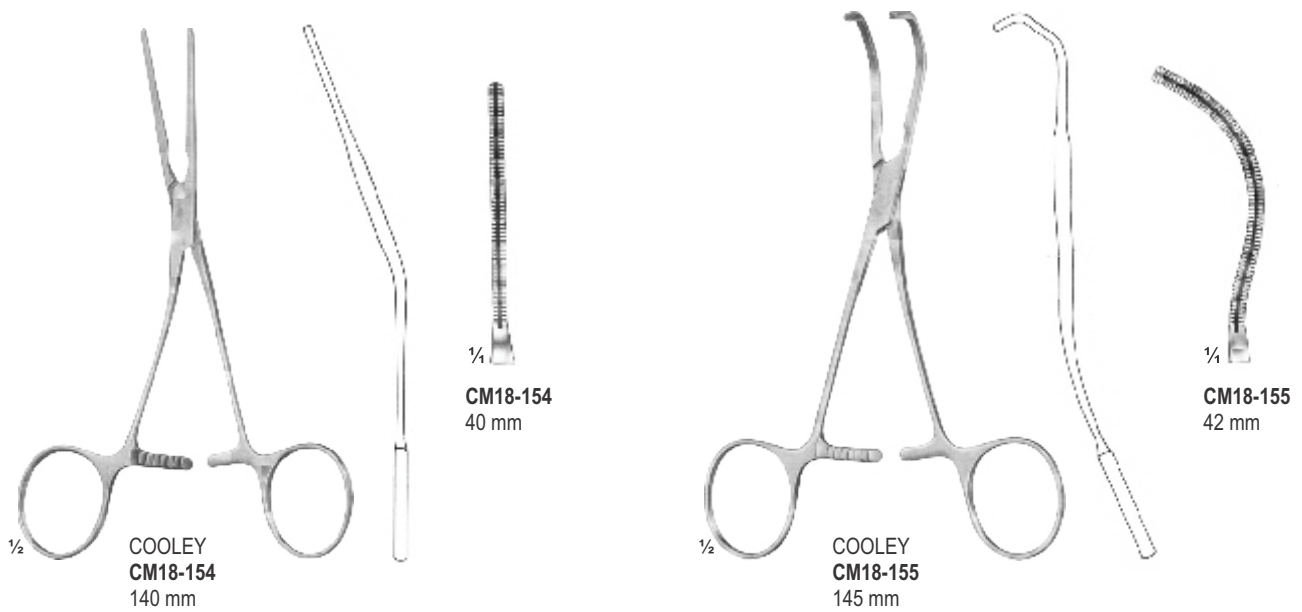
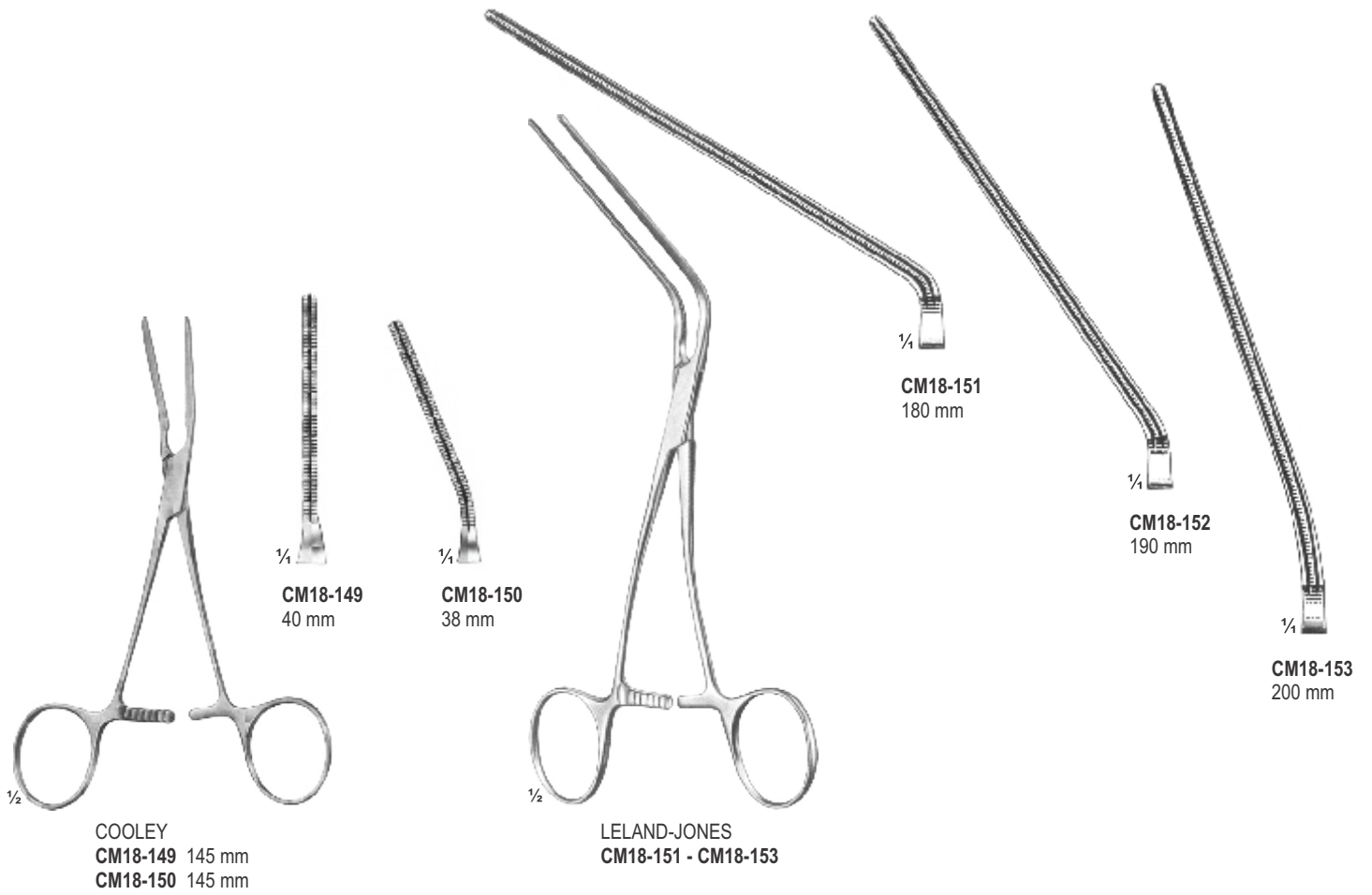

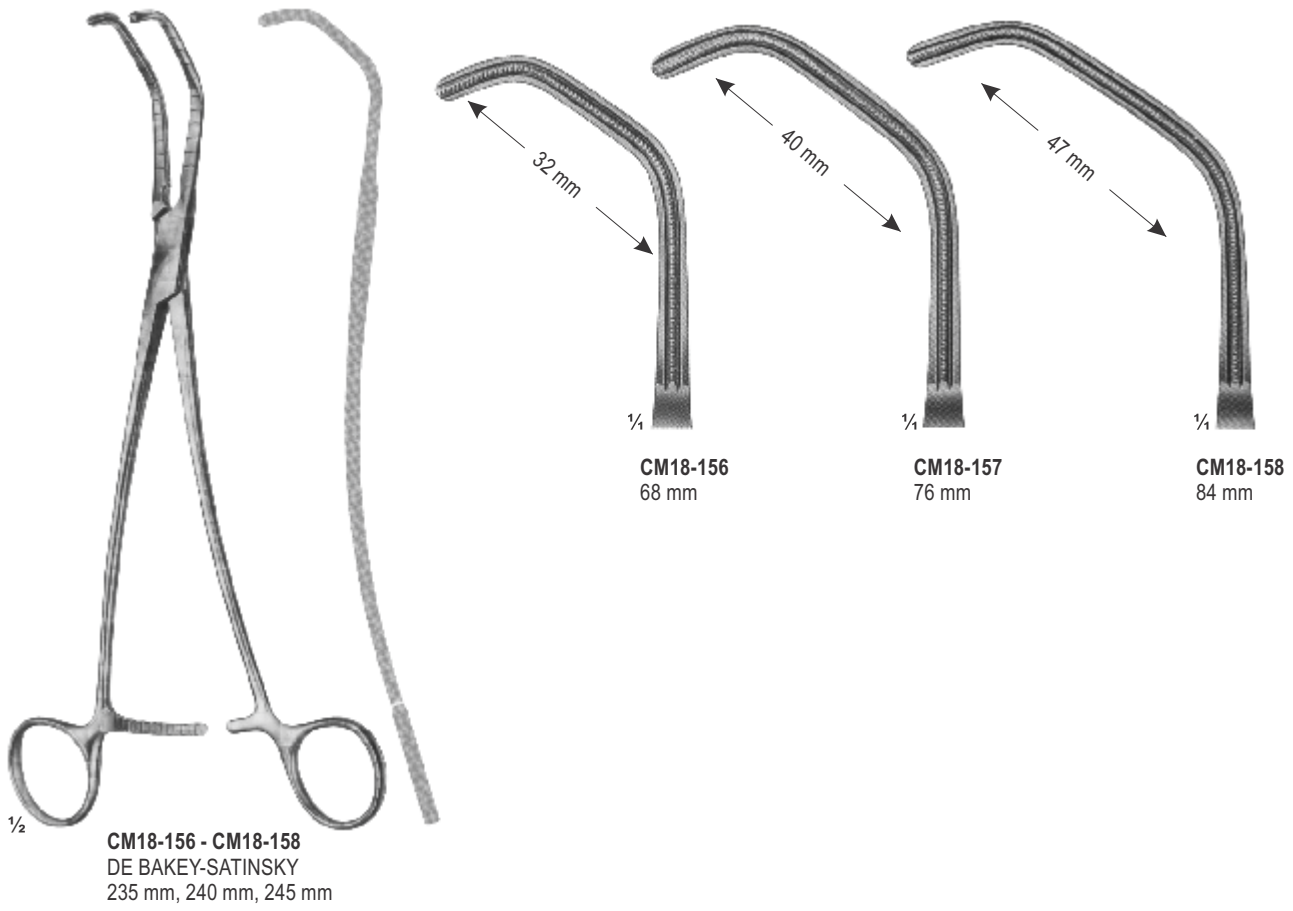

Vascular Clamps

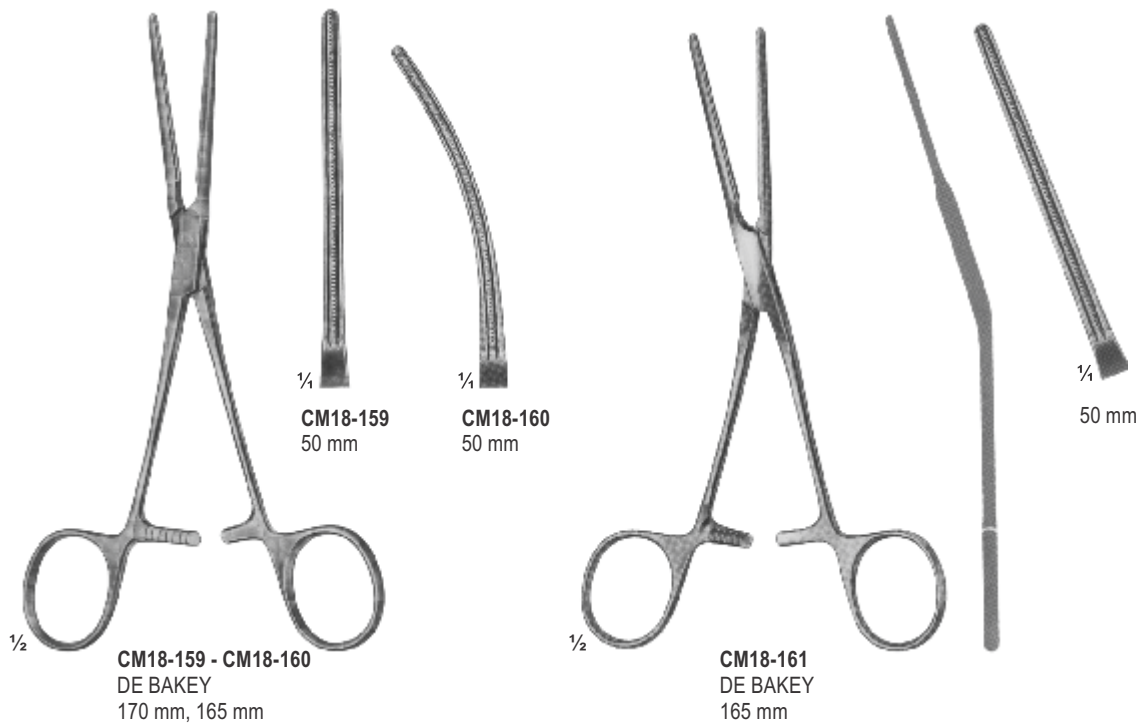



$\frac{1}{2}$ **CM18-162 - CM18-164**
DE BAKEY
205 mm, 225 mm, 240 mm

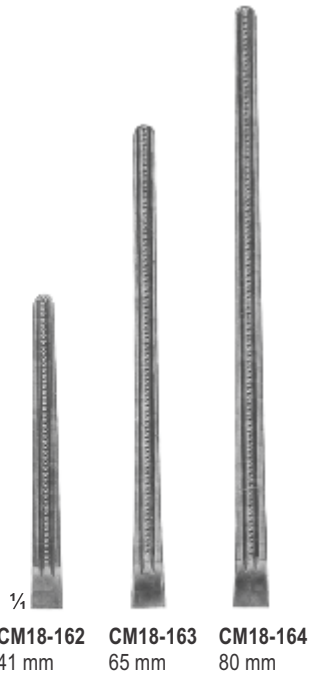

$\frac{1}{4}$
CM18-162 41 mm
CM18-163 65 mm
CM18-164 80 mm



$\frac{1}{2}$ **CM18-165 - CM18-167**
DE BAKEY
200 mm, 225 mm, 240 mm



$\frac{1}{4}$
CM18-165 41 mm
CM18-166 65 mm
CM18-167 80 mm

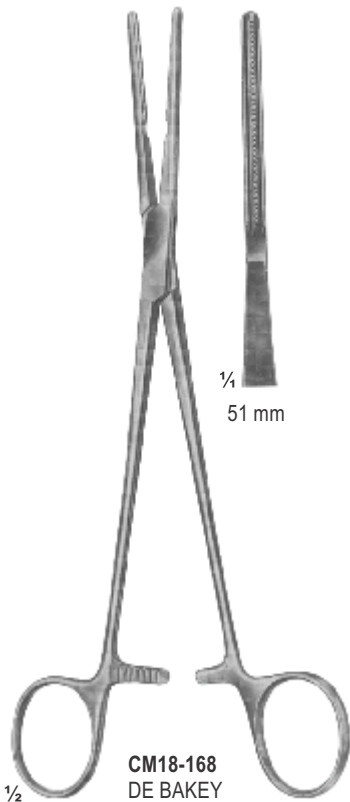

$\frac{1}{2}$ **CM18-168**
DE BAKEY
210 mm



$\frac{1}{4}$
51 mm



$\frac{1}{2}$ **CM18-169**
DE BAKEY
210 mm

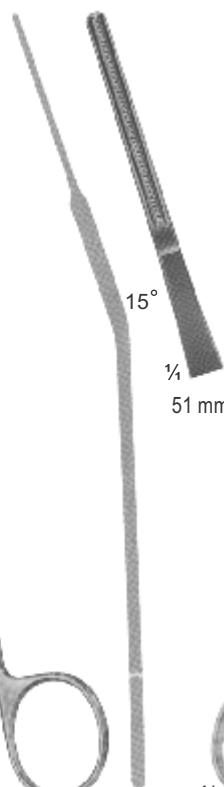

15°
 $\frac{1}{4}$
51 mm

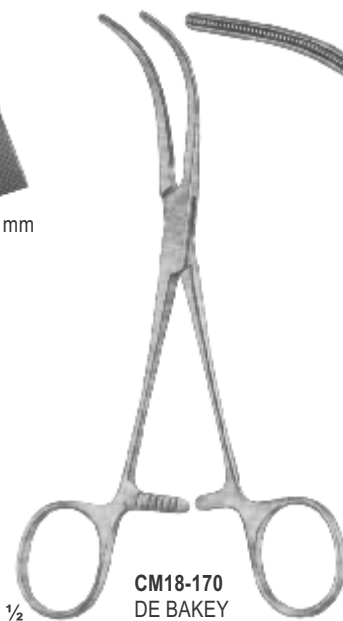

$\frac{1}{2}$ **CM18-170**
DE BAKEY
160 mm

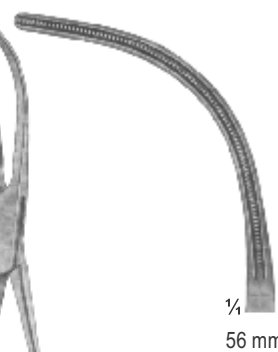

$\frac{1}{4}$
56 mm

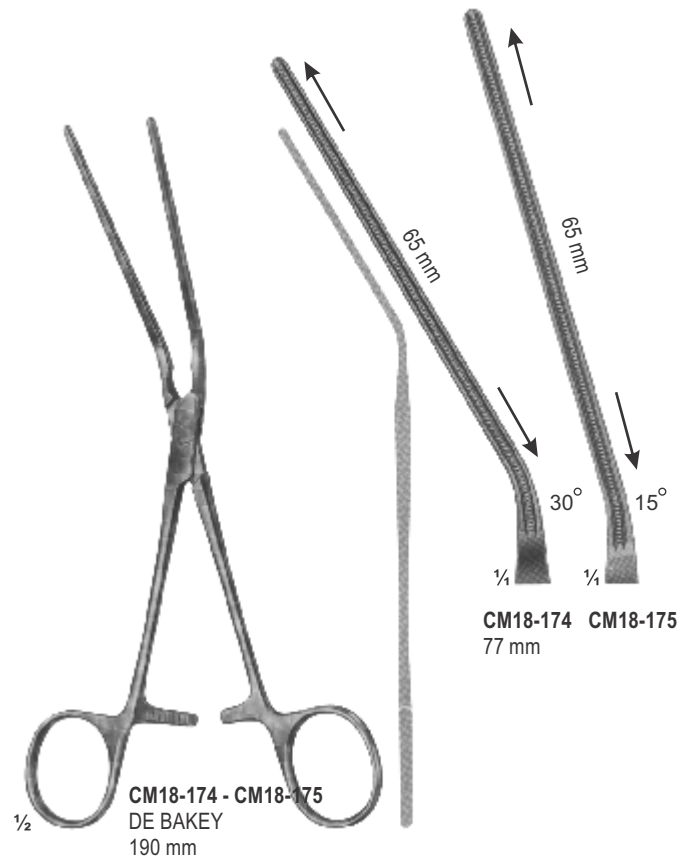
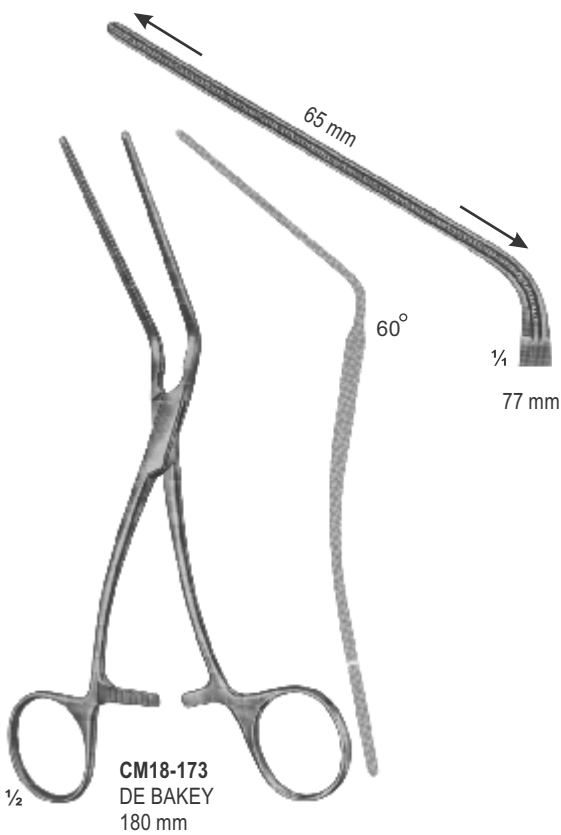
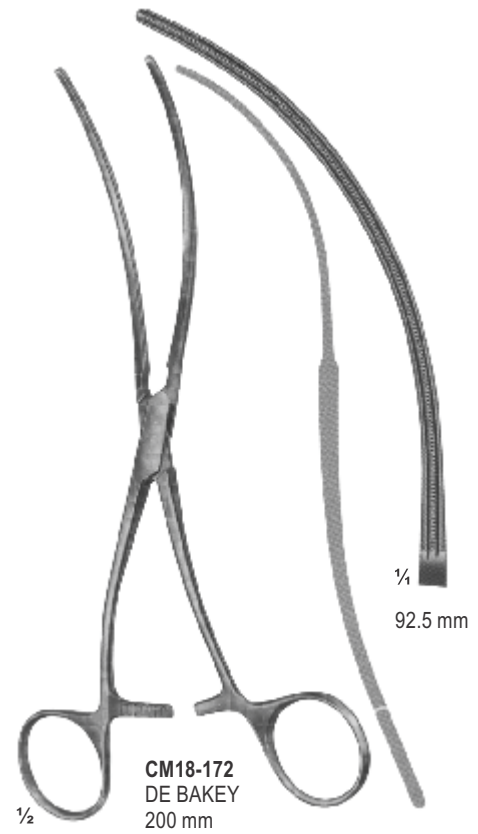
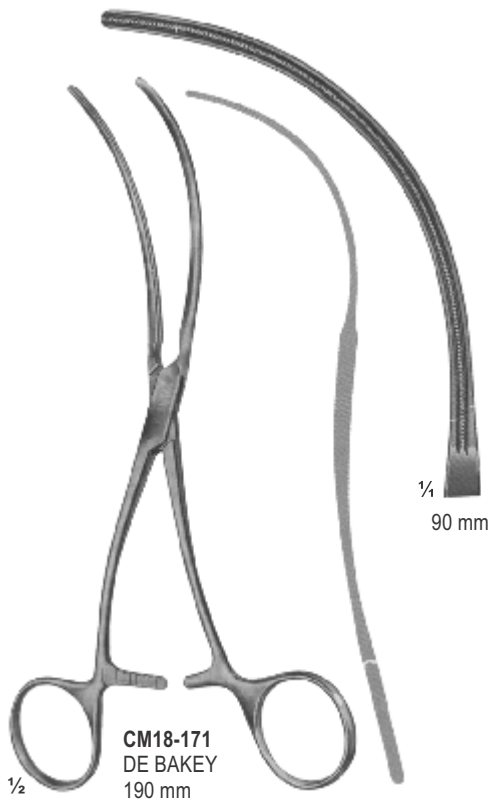

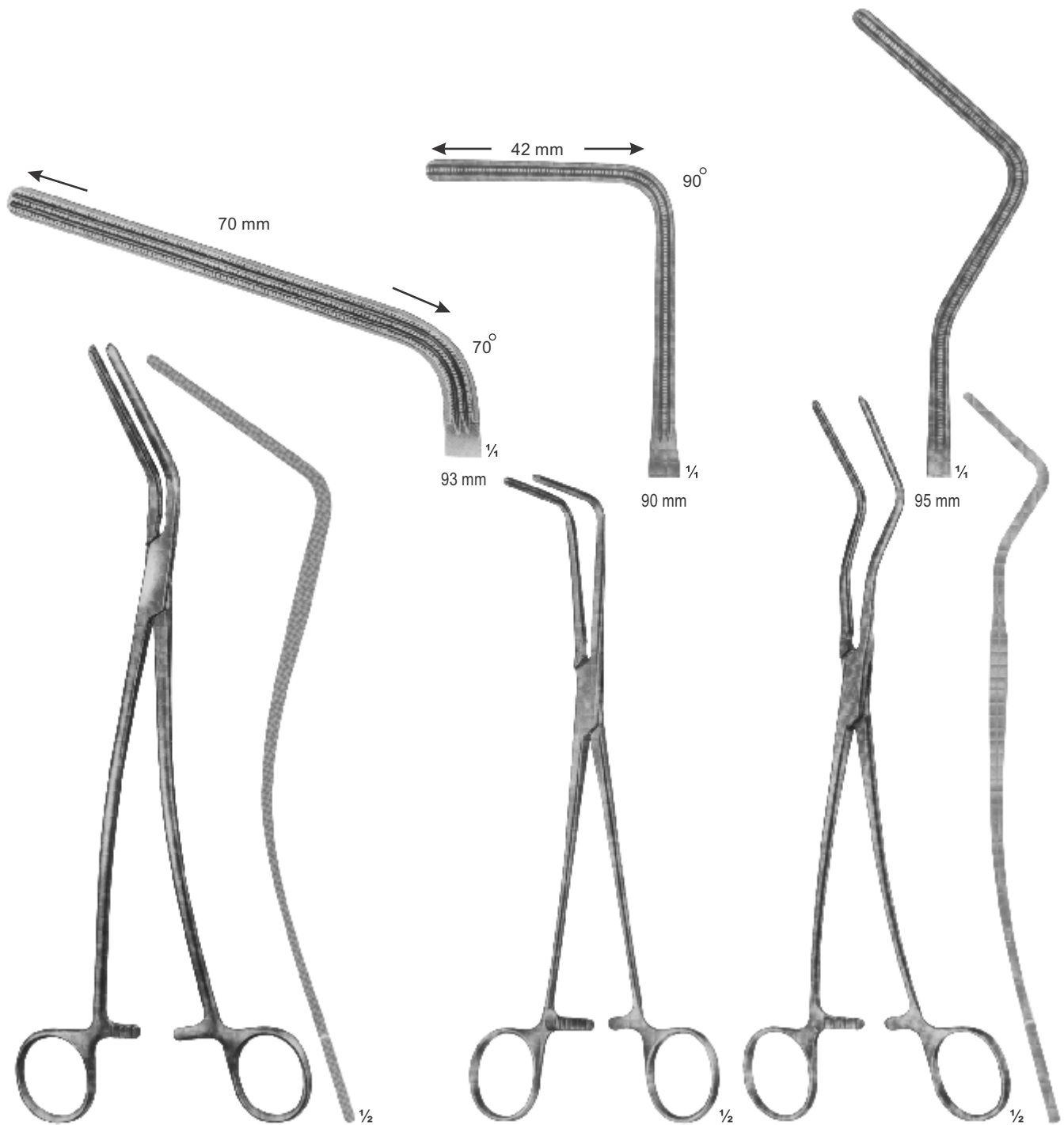

CM18-176
DE BAKY
240 mm

CM18-177
LEES
220 mm

CM18-178
LEES
245 mm

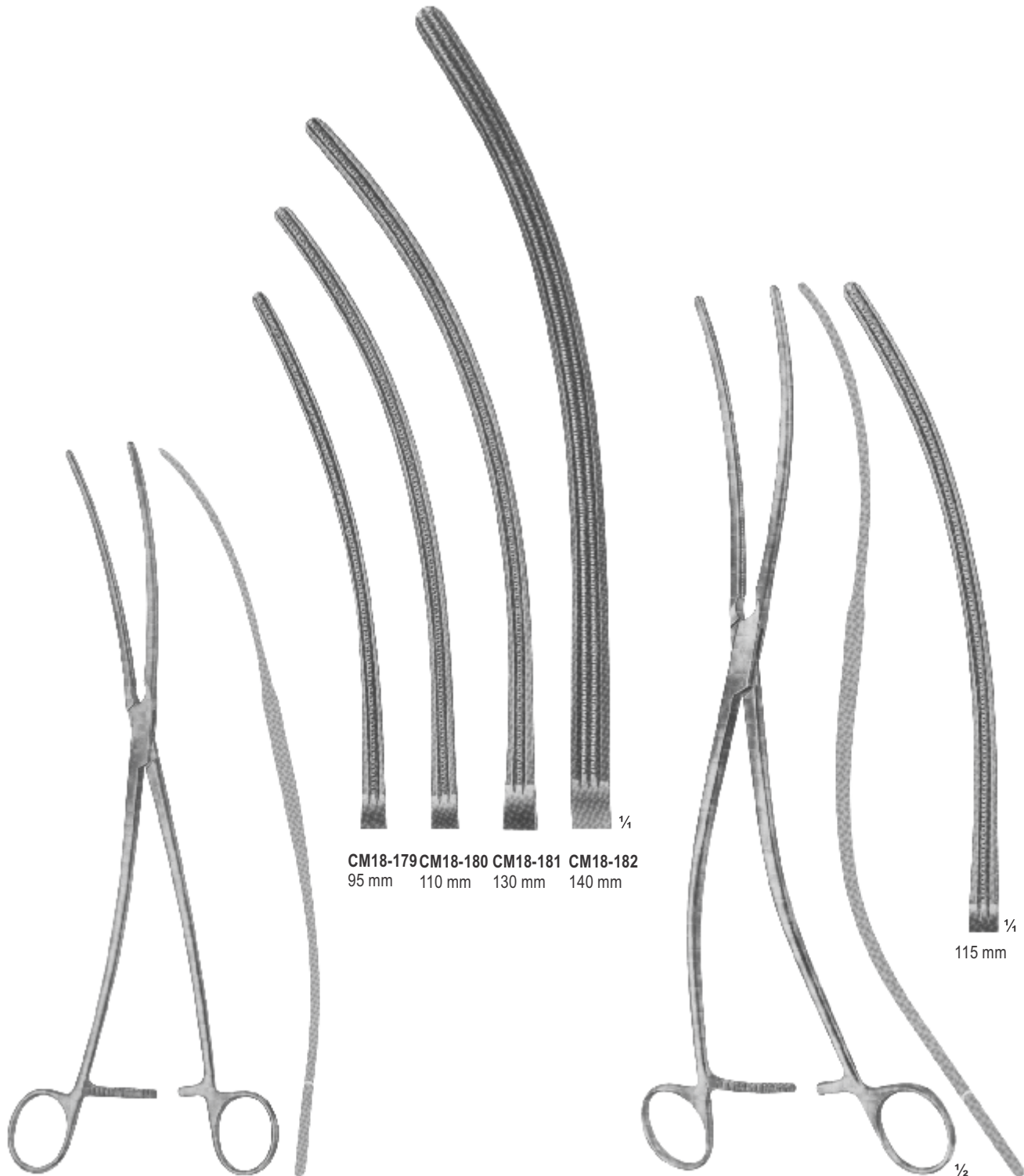

CM18-179 CM18-180 CM18-181 CM18-182
95 mm 110 mm 130 mm 140 mm

CM18-179 - CM18-182
DE BAKAY
250 mm, 300 mm,
315 mm, 330 mm

CM18-183
DE BAKAY
300 mm

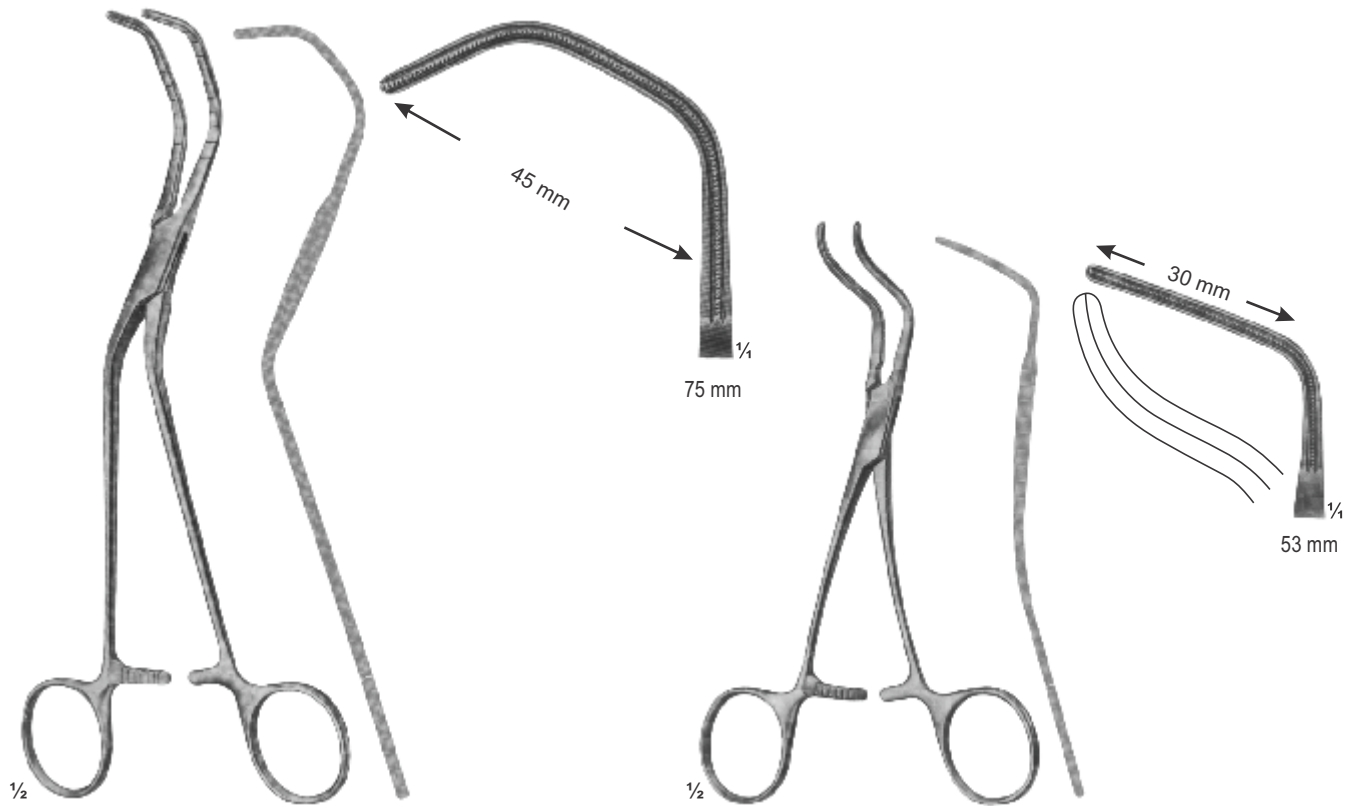

1/2
CM18-184
DIETHRICH
210 mm

1/2
CM18-185
SUBRAMANIAN
155 mm

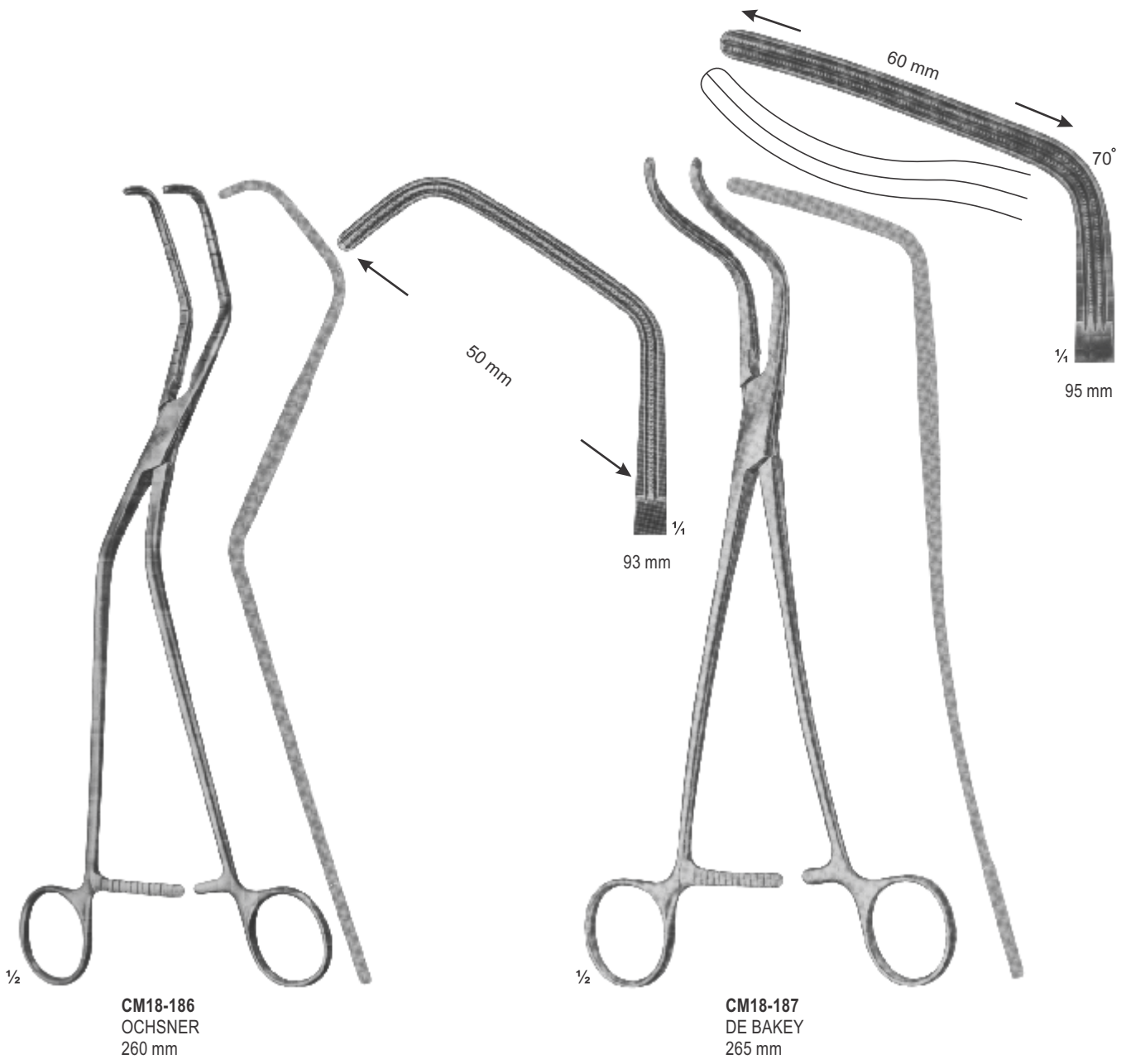

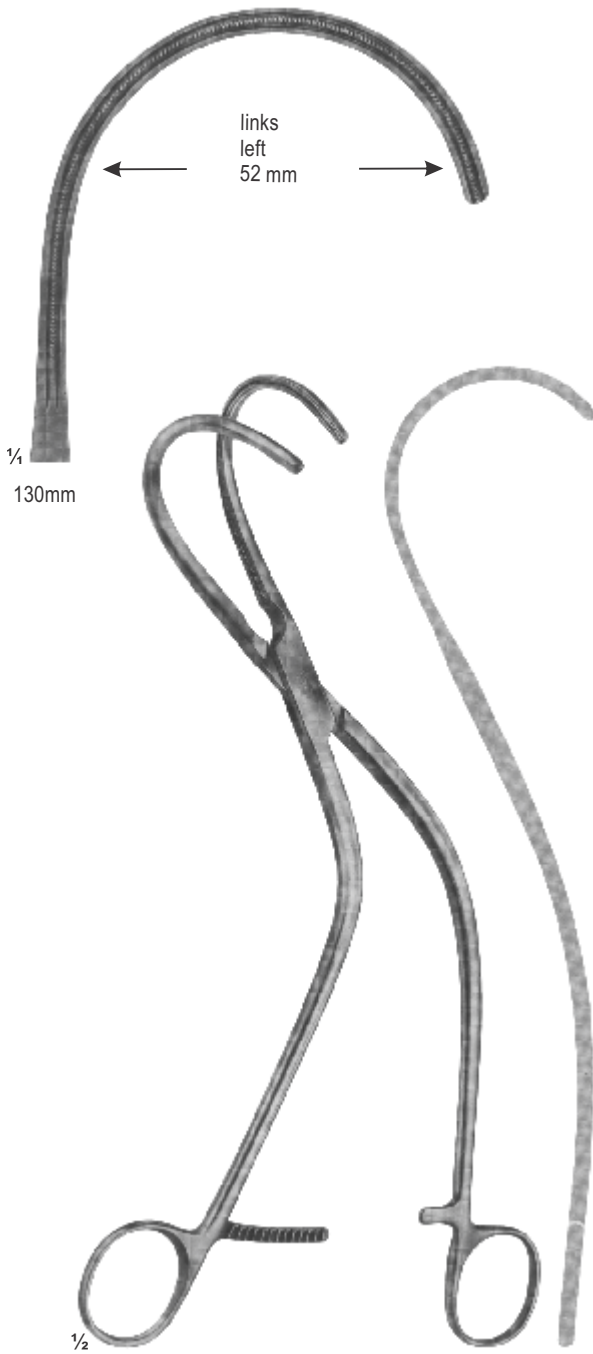

CM18-188
WEBER
265 mm

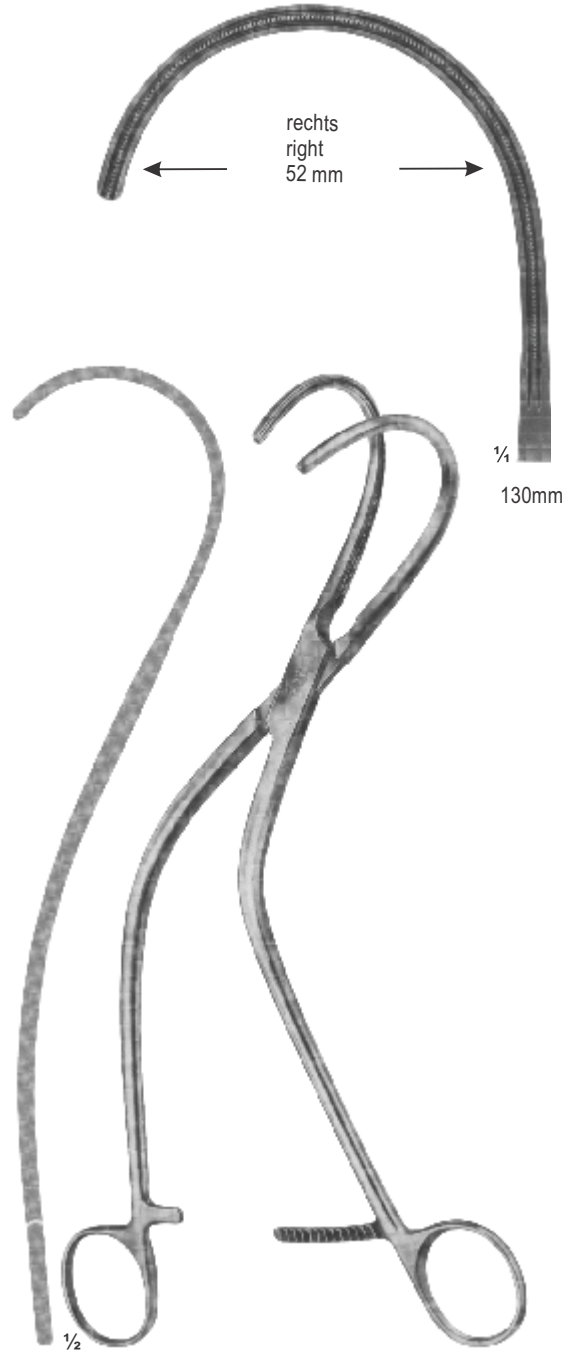

CM18-189
WEBER
265 mm

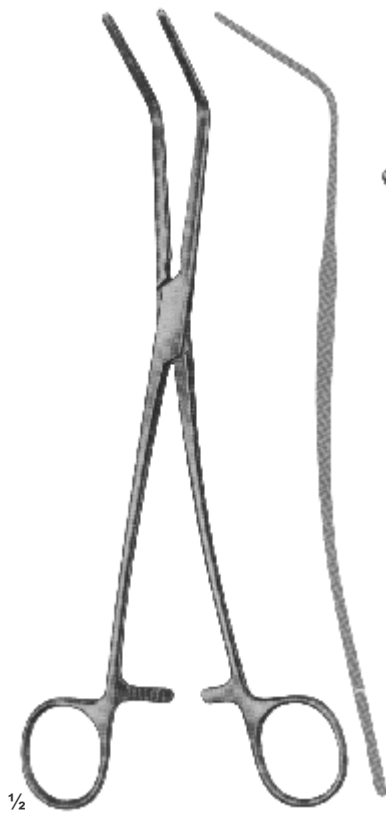

1/2
CM18-190 - CM18-193
DE BAKEY

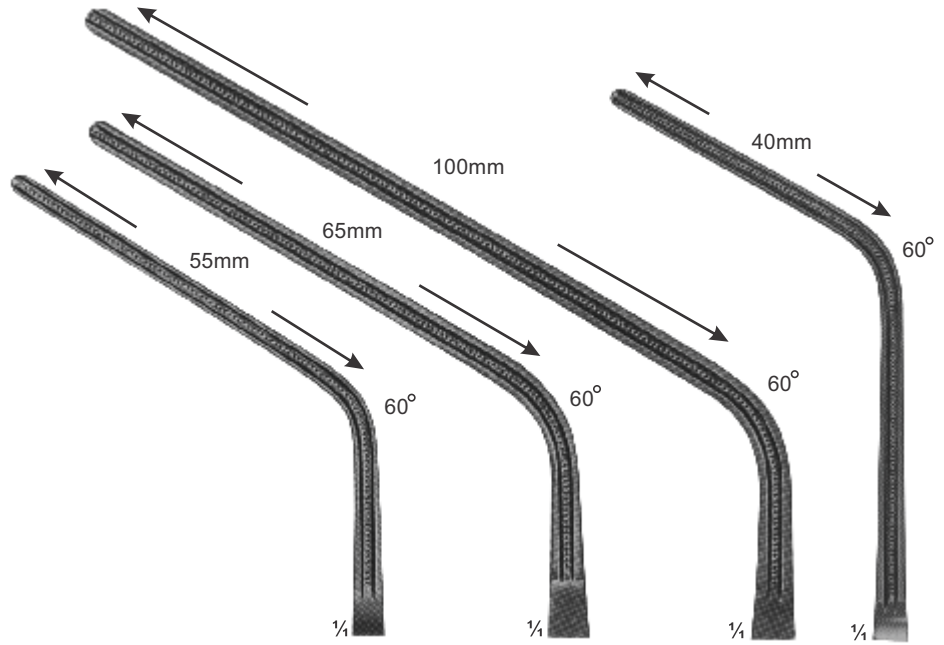

1/4 **CM18-190** 1/4 **CM18-191** 1/4 **CM18-192** 1/4 **CM18-193**

Total Length:	230 mm	280 mm	305 mm	240 mm
Length of jaws:	85 mm	100 mm	135 mm	93 mm



1/2
CM18-194 - CM18-197
DE BAKEY

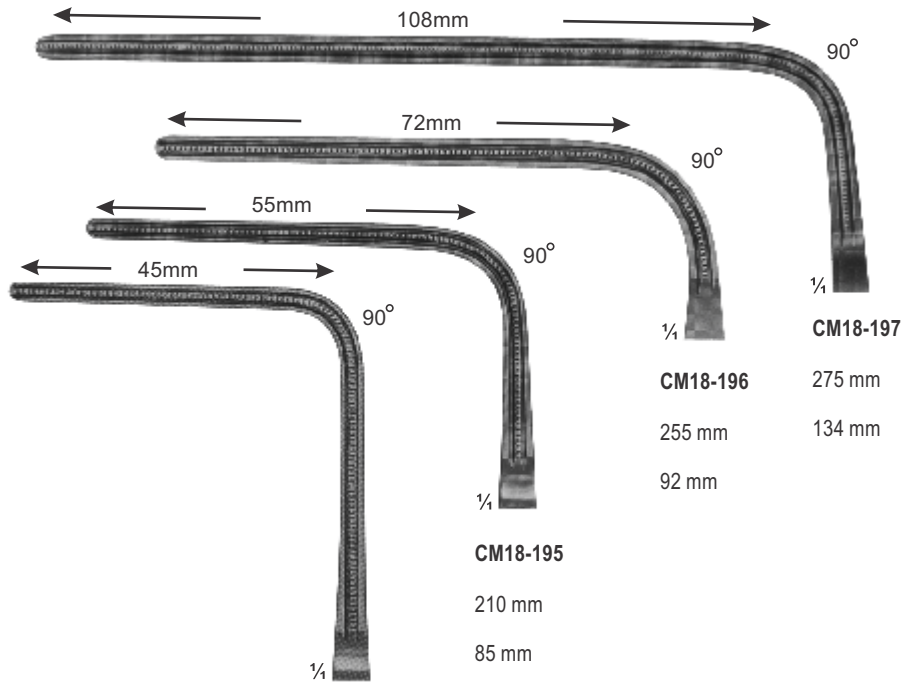

1/4 **CM18-194** 1/4 **CM18-195** 1/4 **CM18-196** 1/4 **CM18-197**

Total Length:	225 mm	210 mm	255 mm	275 mm
Length of jaws:	93 mm	85 mm	92 mm	134 mm

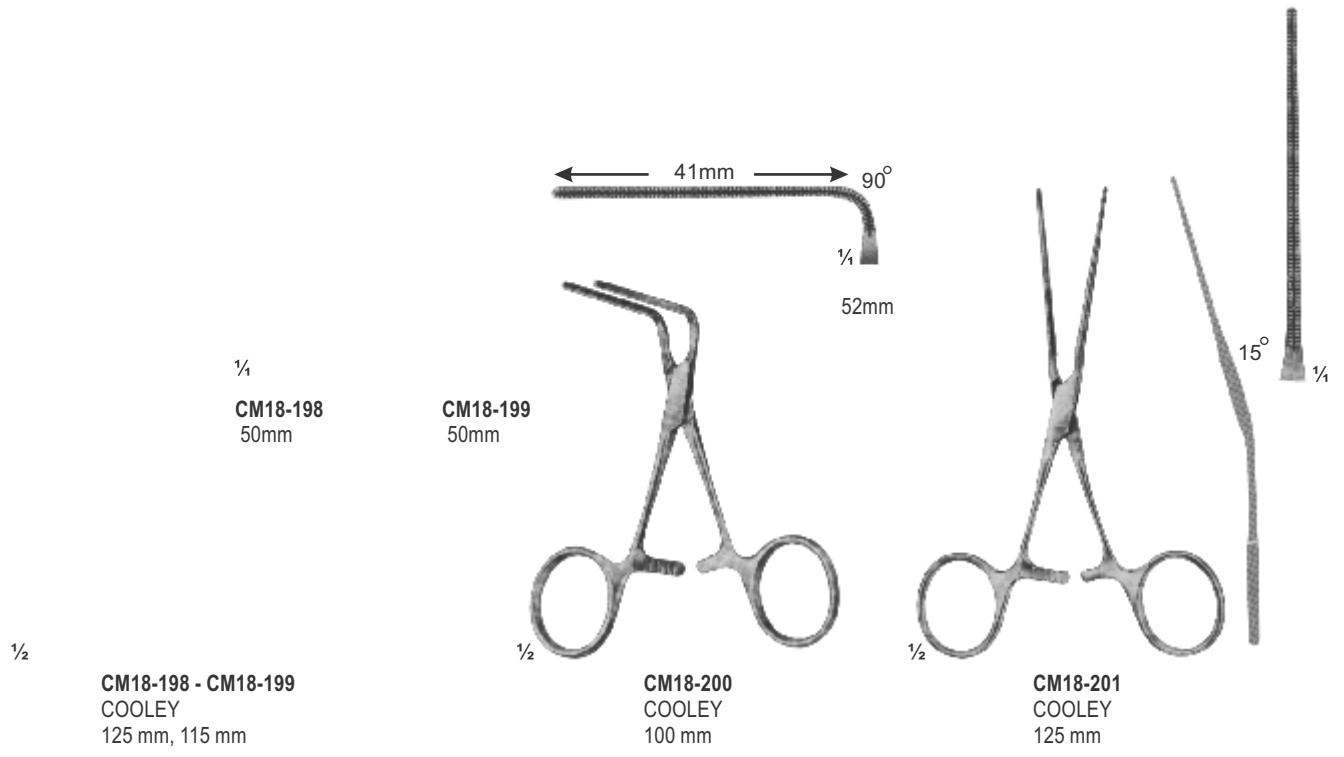

Anastomosis Clamps, Pediatric Patterns

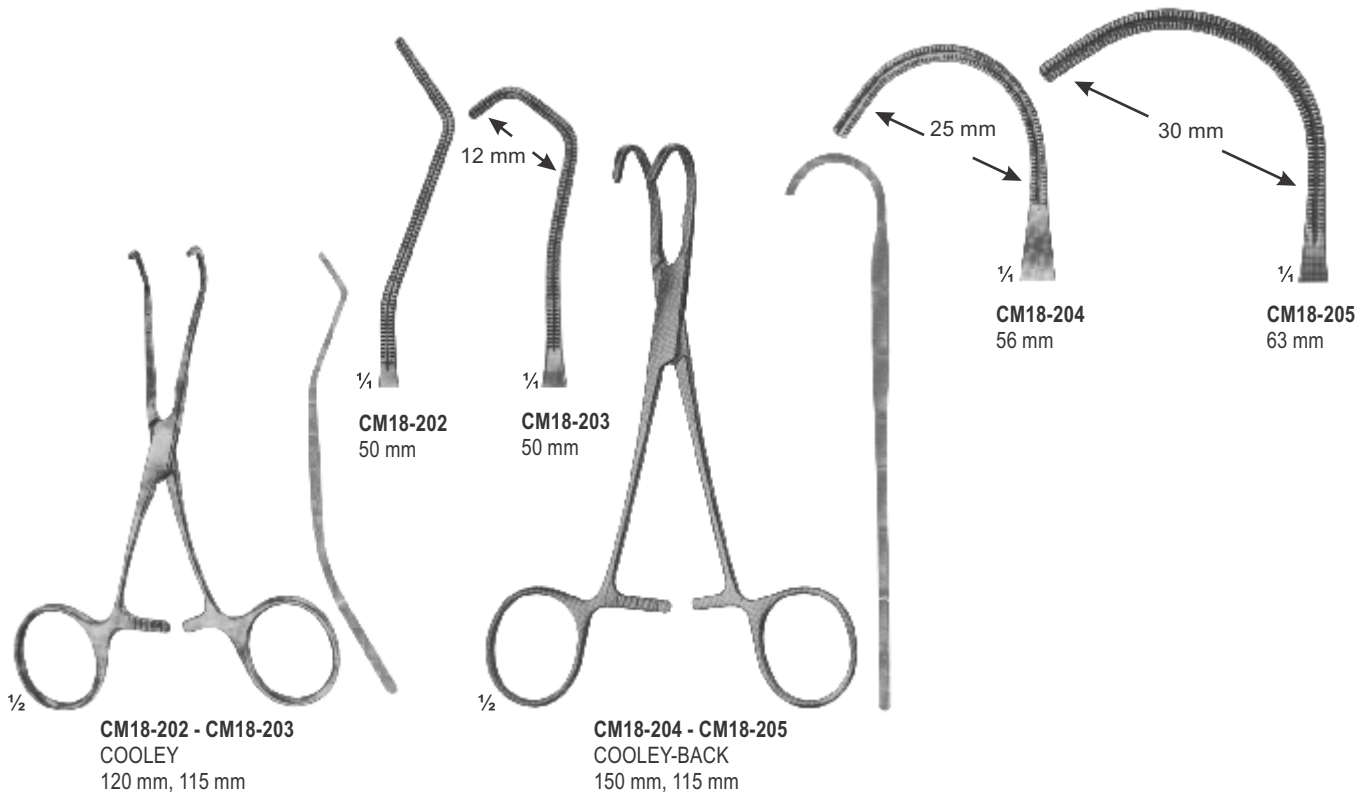

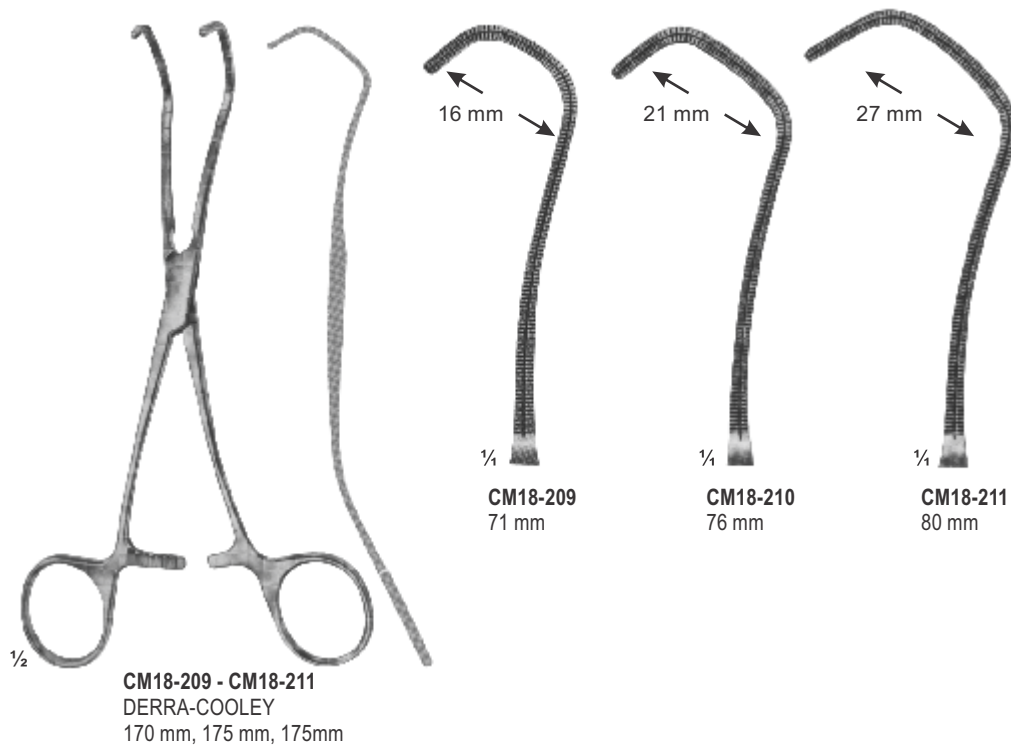
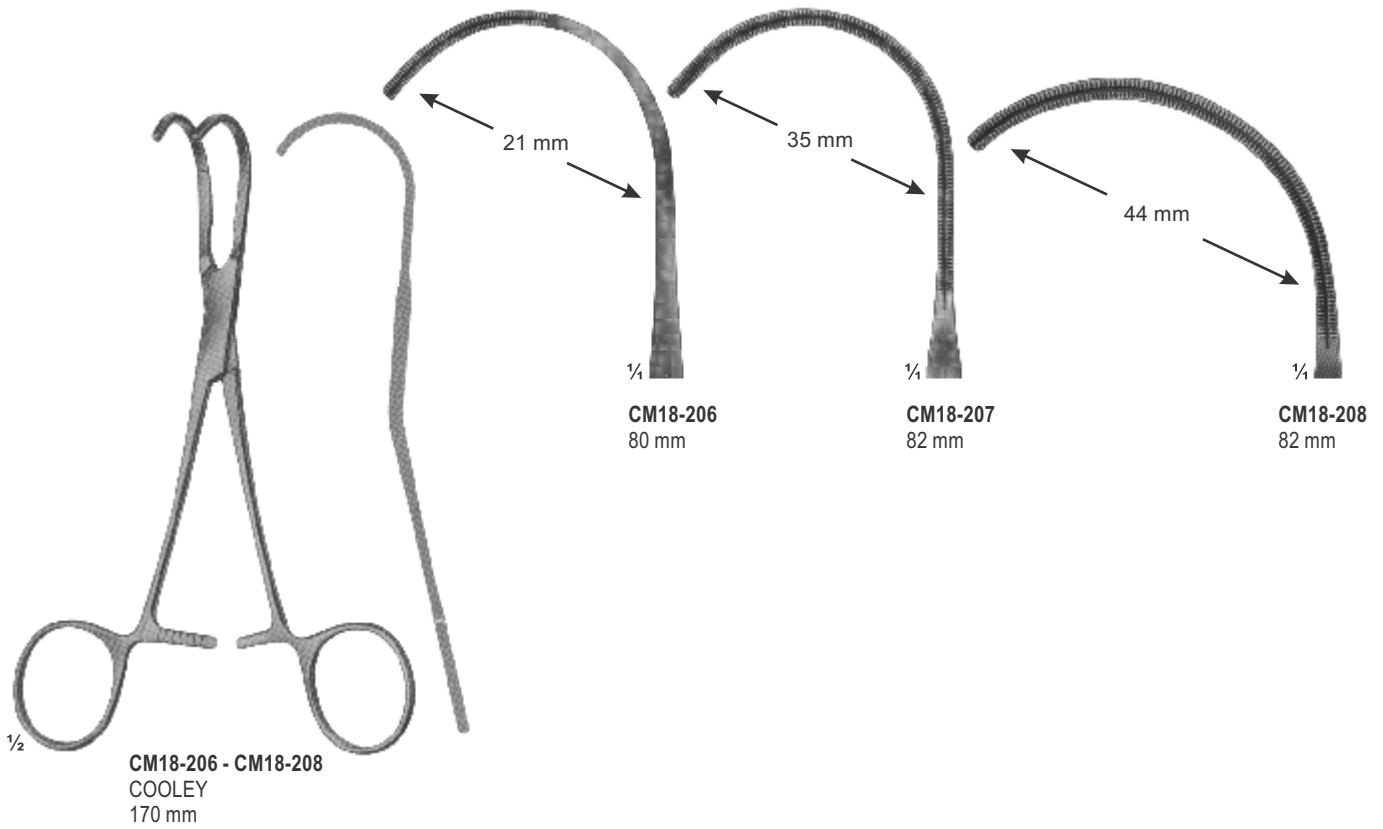



1/2

CM18-212 - CM18-215
COOLEY
165 mm, 165 mm
175 mm, 180 mm

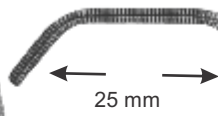

1/4

CM18-212
72 mm

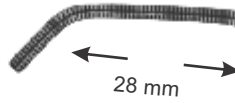

1/4

CM18-213
76 mm

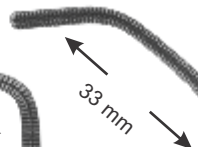

1/4

CM18-214
72 mm

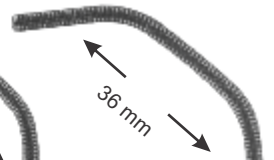

1/4

CM18-215
76 mm

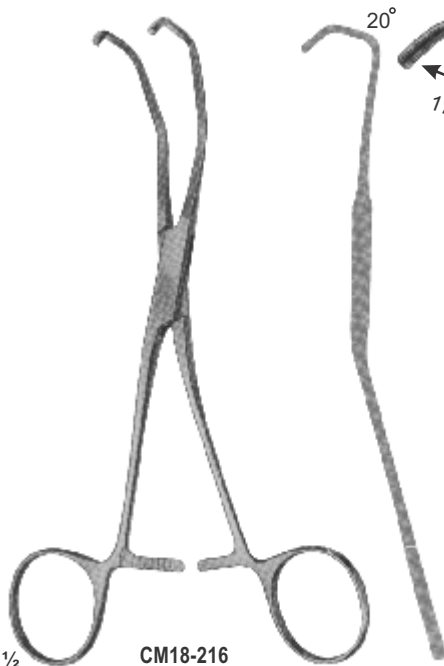

1/2

CM18-216
COOLEY
170 mm

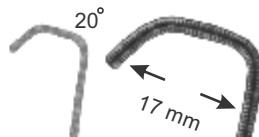

1/4

72 mm

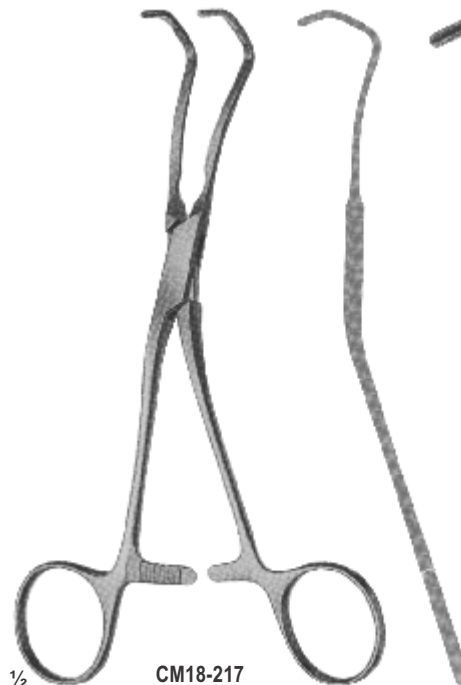

1/2

CM18-217
COOLEY
175 mm

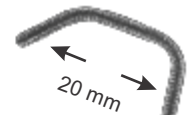

1/4

74mm

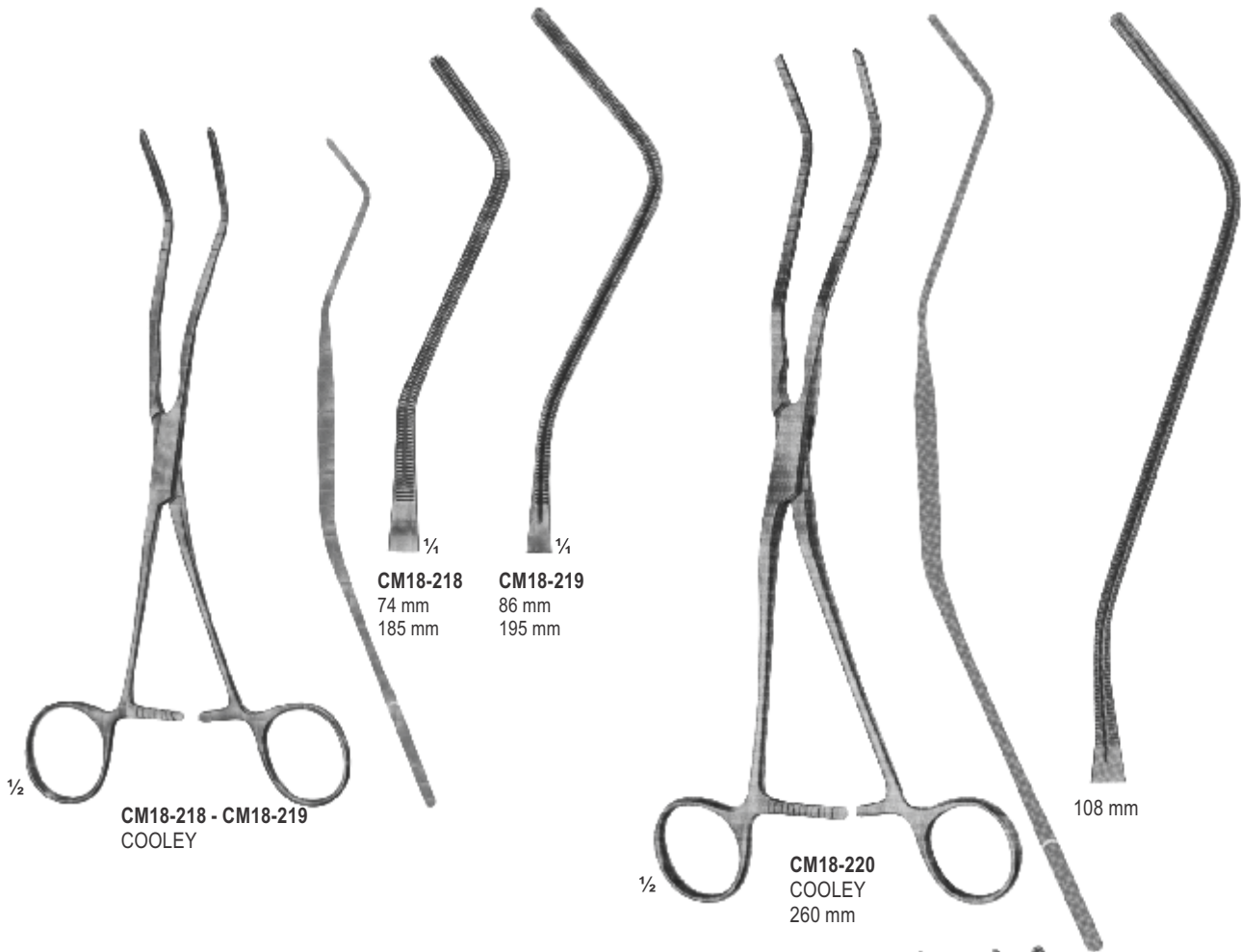

$\frac{1}{2}$
CM18-218 - CM18-219
COOLEY

CM18-218
74 mm
185 mm

CM18-219
86 mm
195 mm

$\frac{1}{2}$
CM18-220
COOLEY
260 mm

108 mm

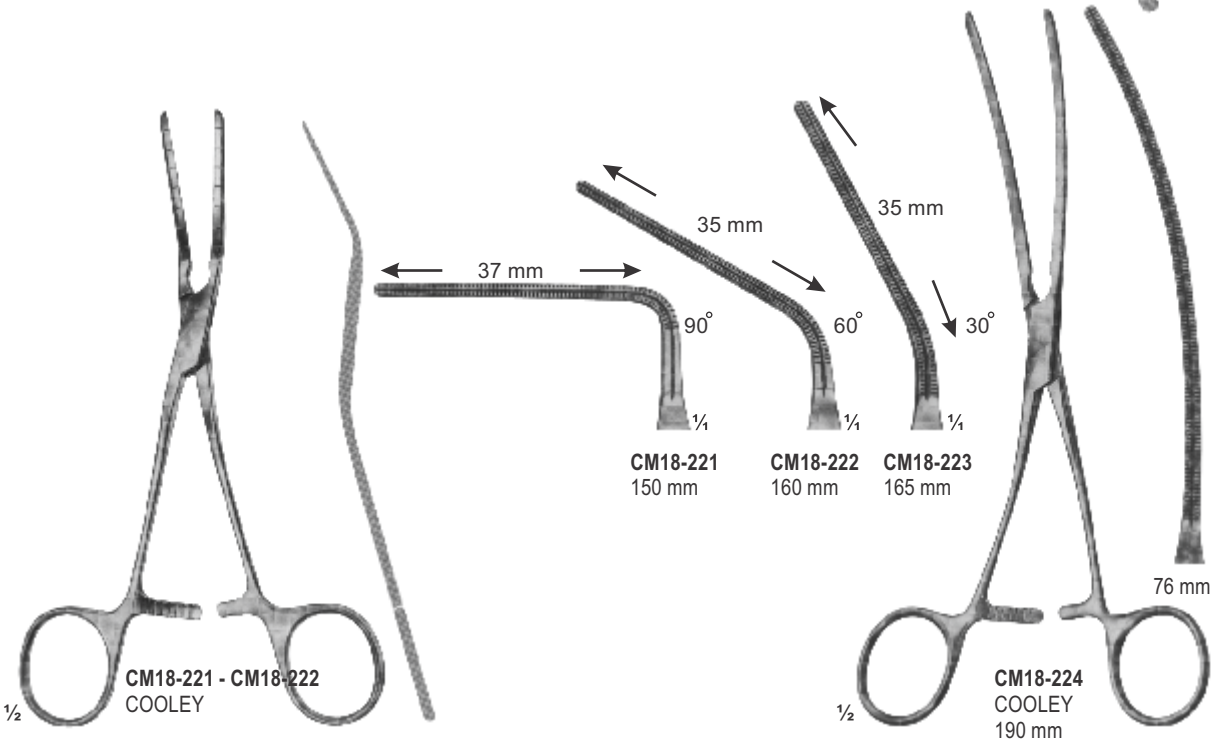

$\frac{1}{2}$
CM18-221 - CM18-222
COOLEY

CM18-221
150 mm

CM18-222
160 mm

CM18-223
165 mm

$\frac{1}{2}$
CM18-224
COOLEY
190 mm

76 mm

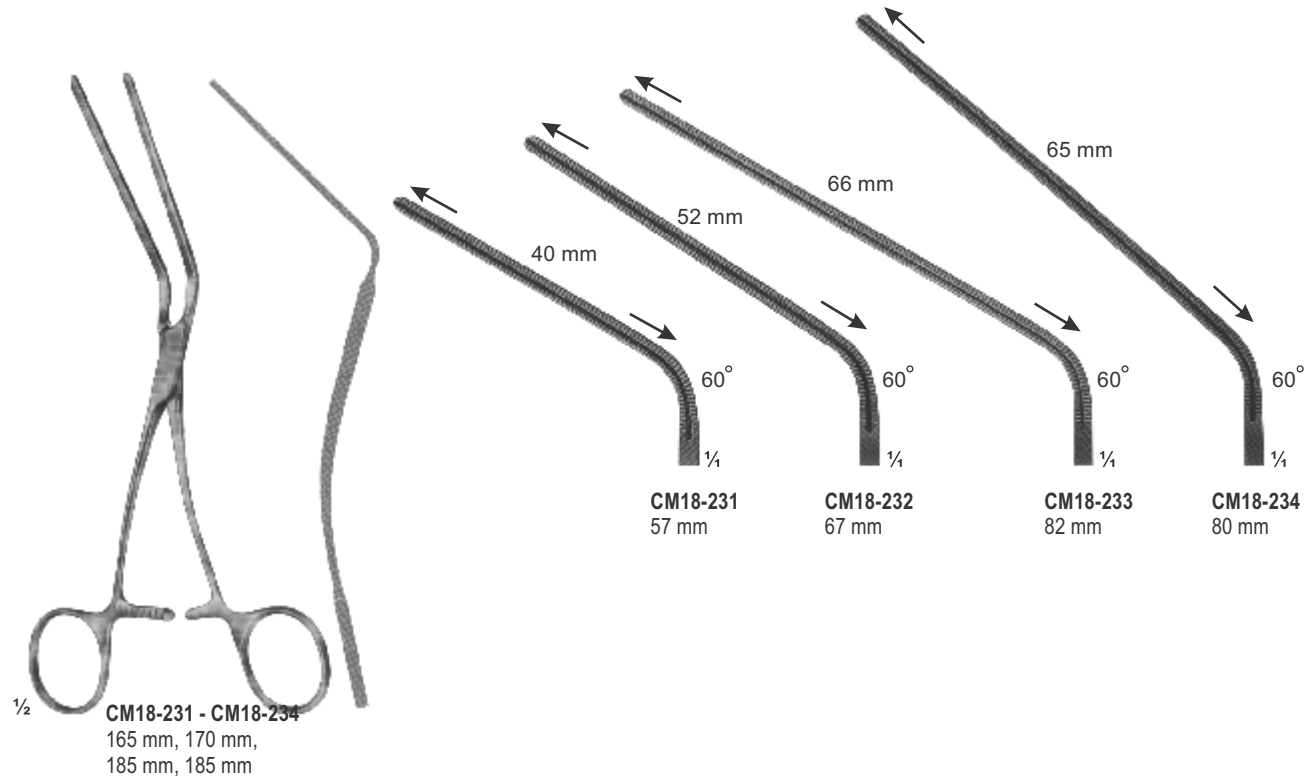
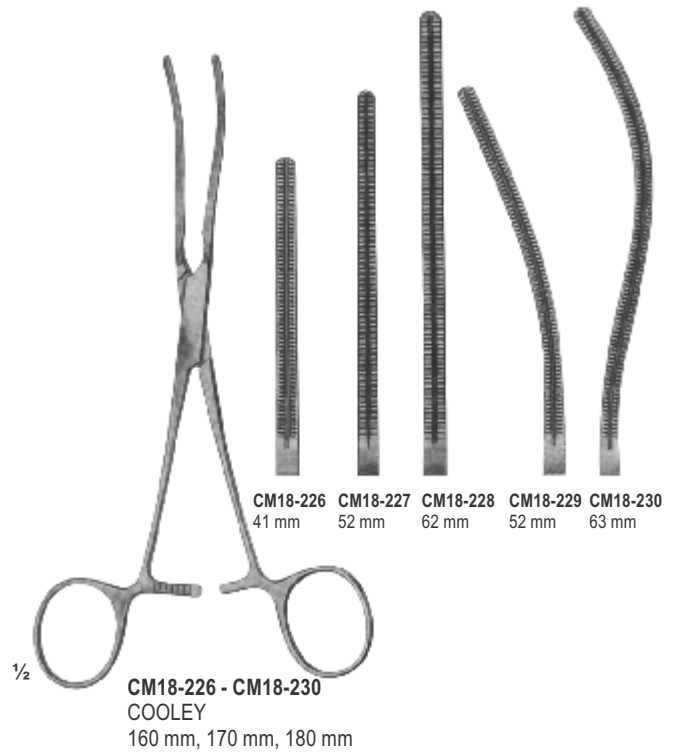
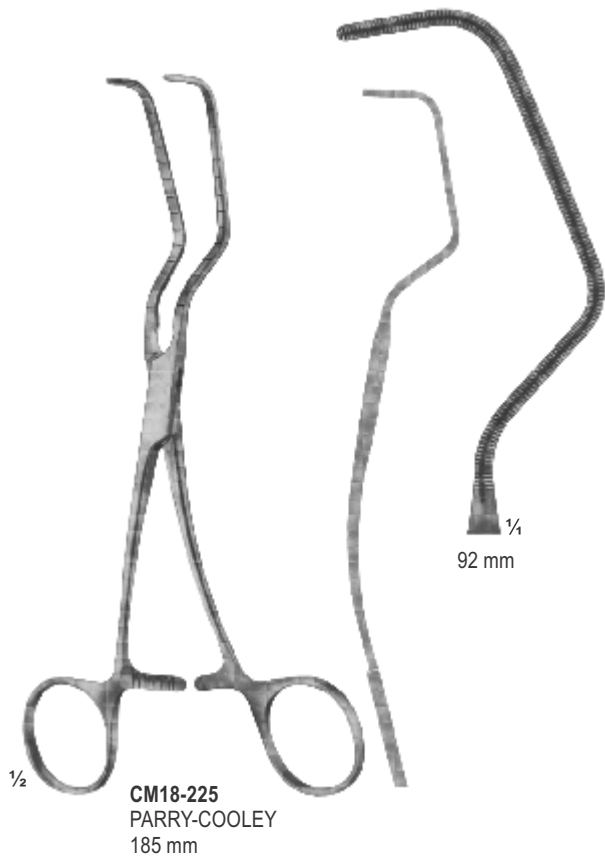



1/2 DARDIK
CM18-235 150 mm
CM18-236 150 mm
CM18-237 150 mm
CM18-238 145 mm
CM18-239 130 mm

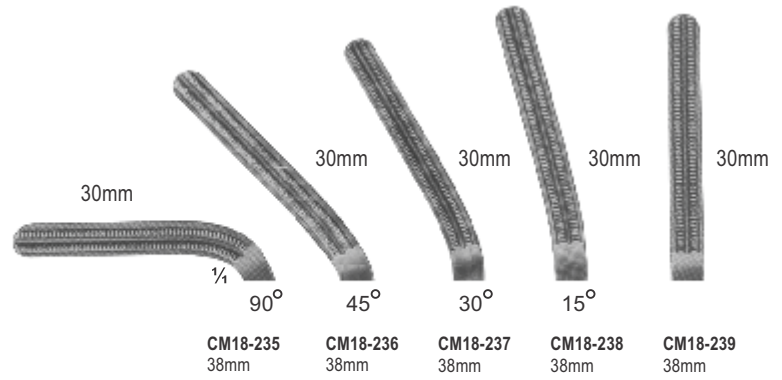

1/2 DARDIK
CM18-235 170 mm
CM18-236 170 mm
CM18-237 170 mm
CM18-238 160 mm
CM18-239 135 mm

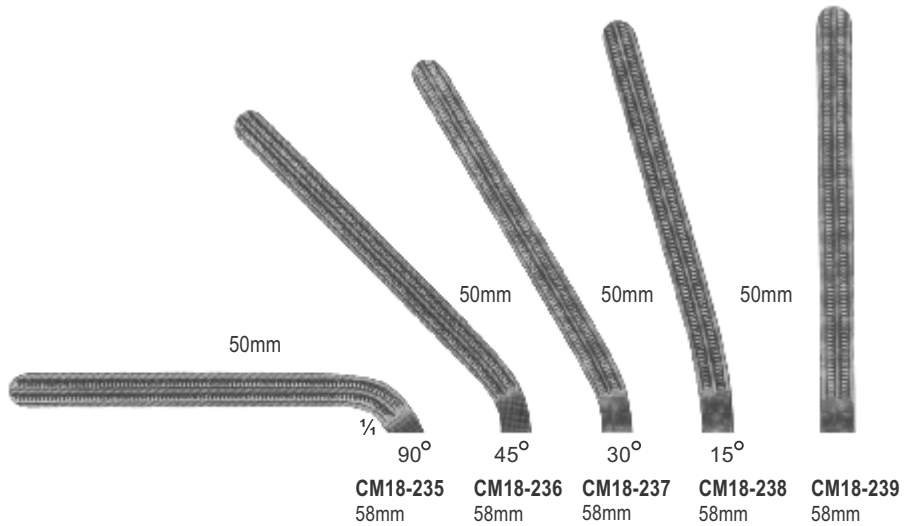

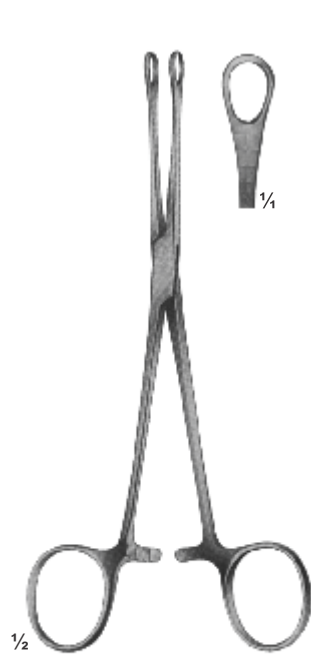

CM18-240
WILLIAMS
160 mm



CM18-241
TUTTLE
230 mm



CM18-242
NELSON
230 mm



CM18-243
DUVAL
230 mm

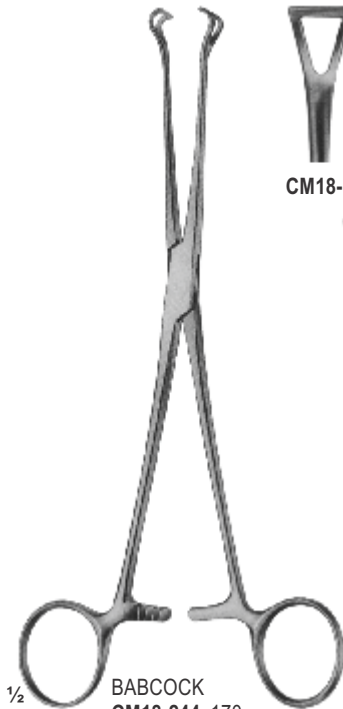

BABCOCK
CM18-244 170 mm
CM18-245 215 mm
CM18-246 220 mm



CM18-247
ALLIS
220 mm

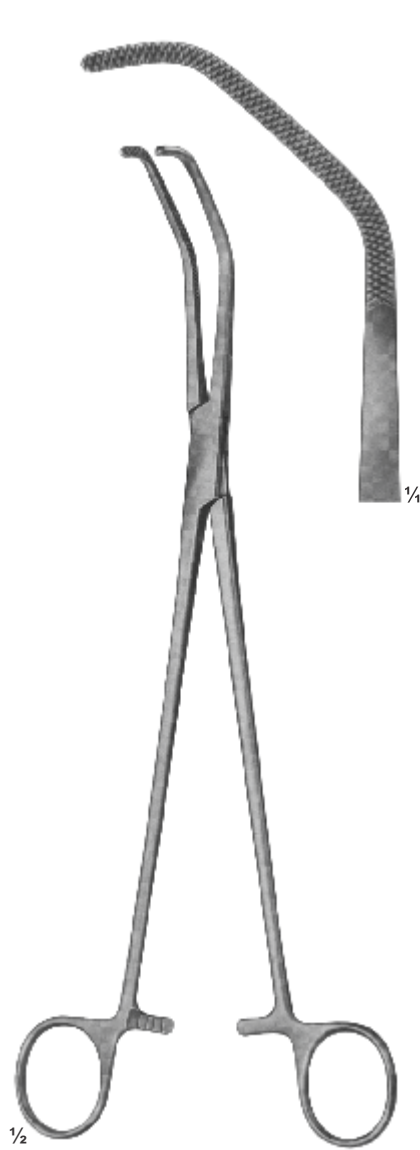

CM18-248
SATINSKY
265 mm



CM18-249
SATINSKY
265 mm

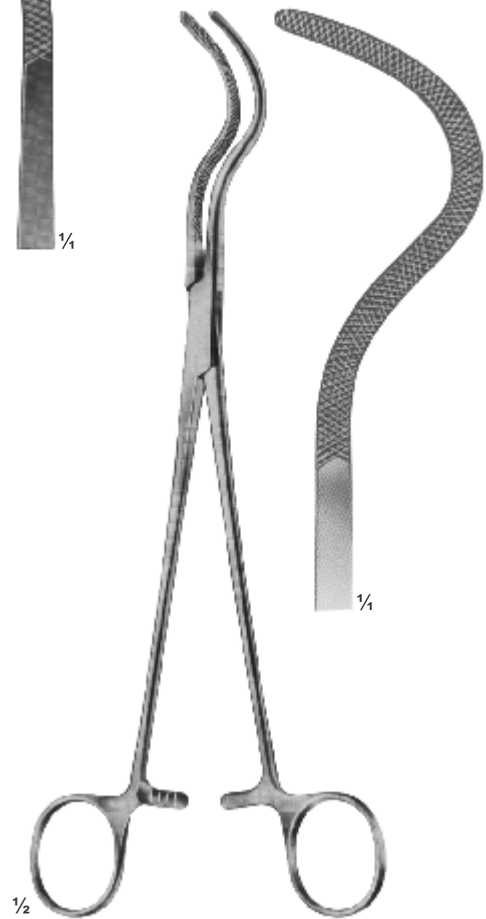

CM18-250
HARKEN
240 mm

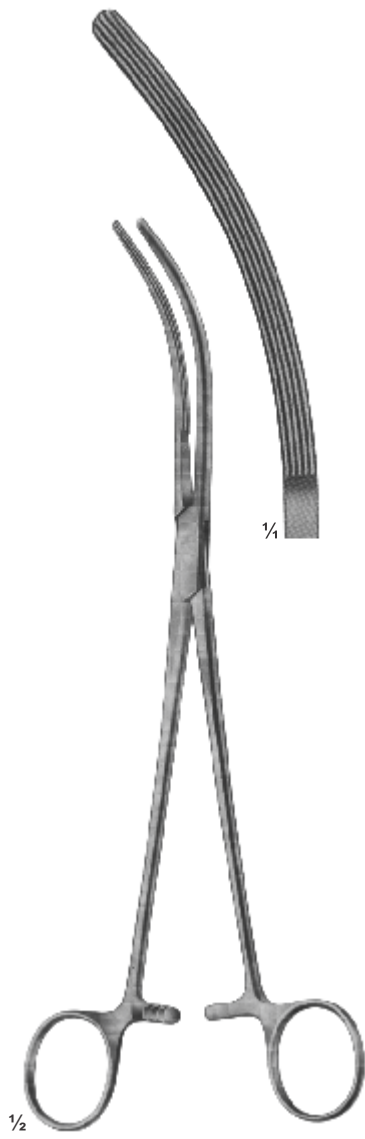

CM18-251
CRAFOORD-SELLORS
240 mm

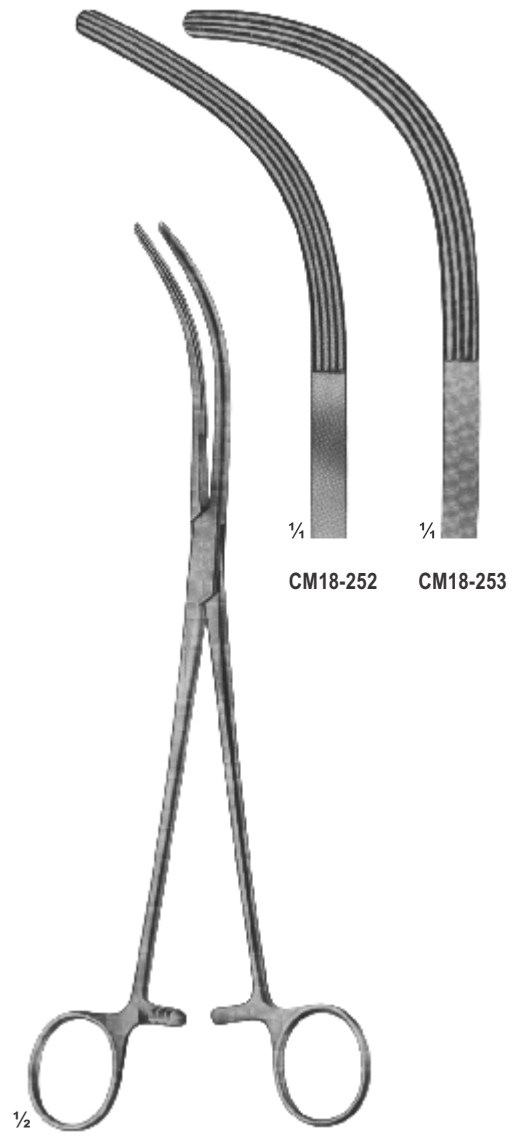

CM18-252 - CM18-253
CRAFOORD
240 mm



CM18-254
PRICE THOMAS
225 mm

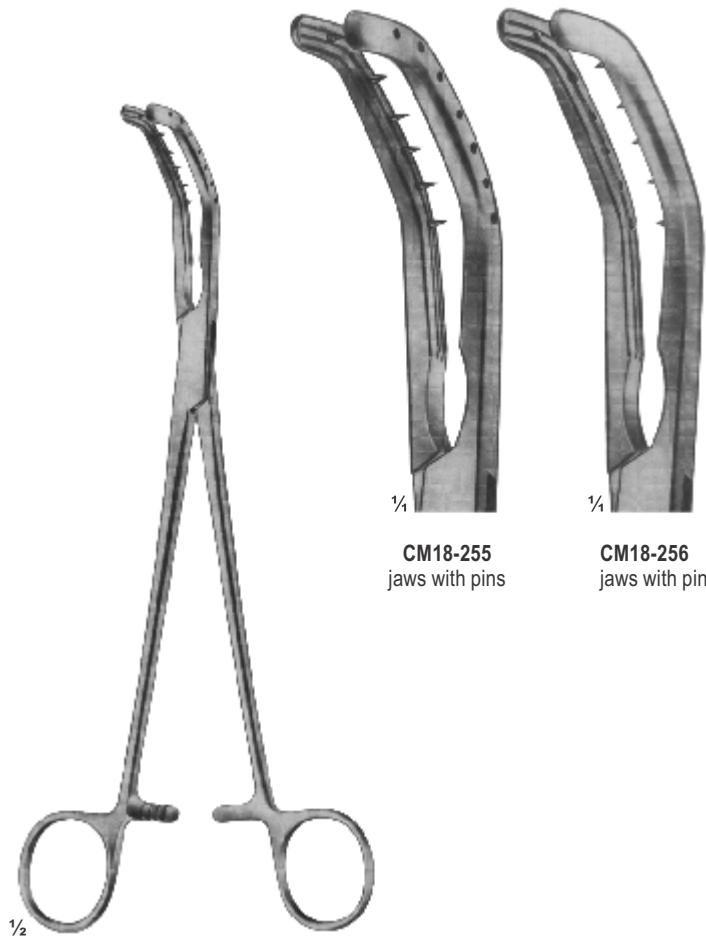

CM18-255
jaws with pins

CM18-256
jaws with pins

CM18-255 - CM18-256
PRICE THOMAS
225 mm

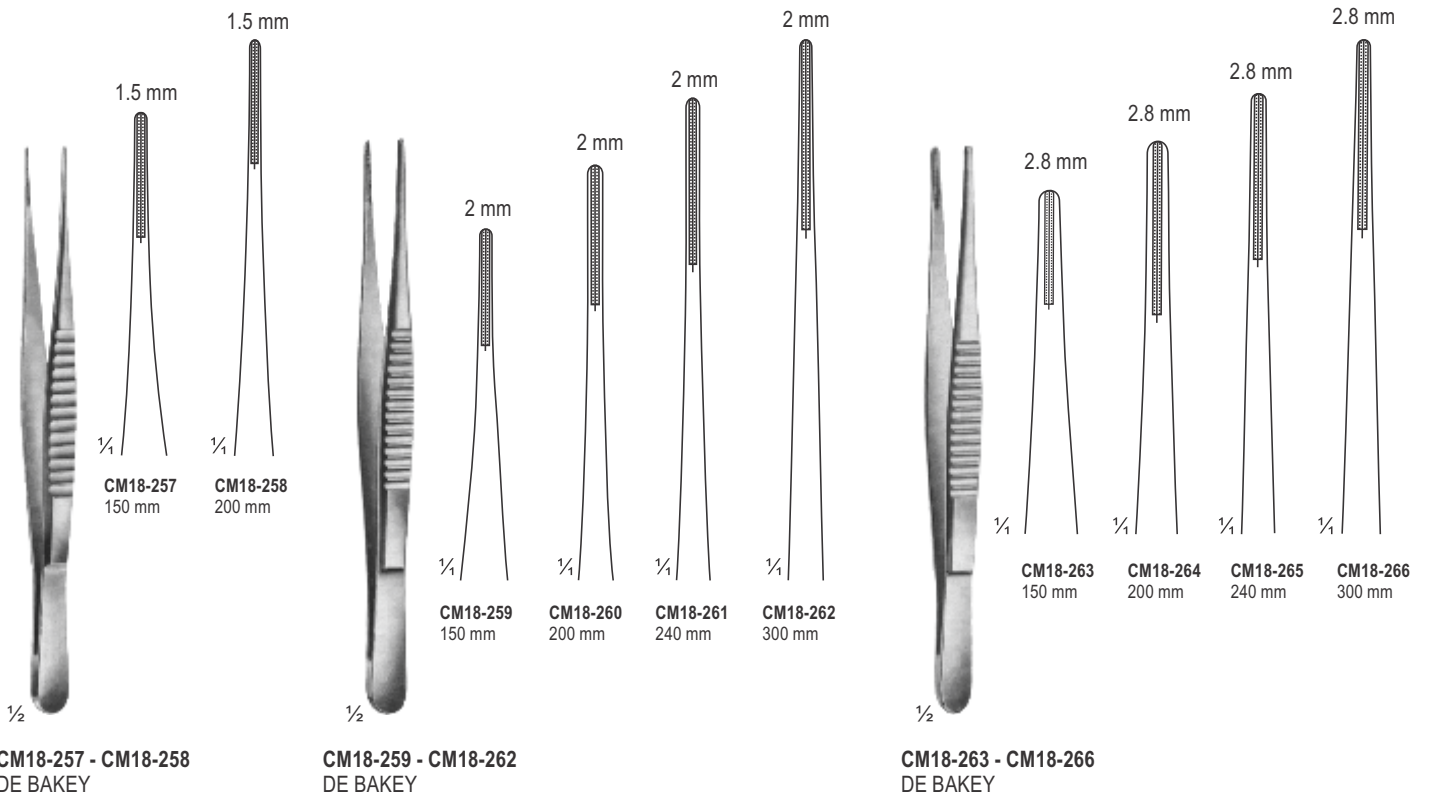

CM18-257 - CM18-258
DE BAKEY

CM18-259 - CM18-262
DE BAKEY

CM18-263 - CM18-266
DE BAKEY

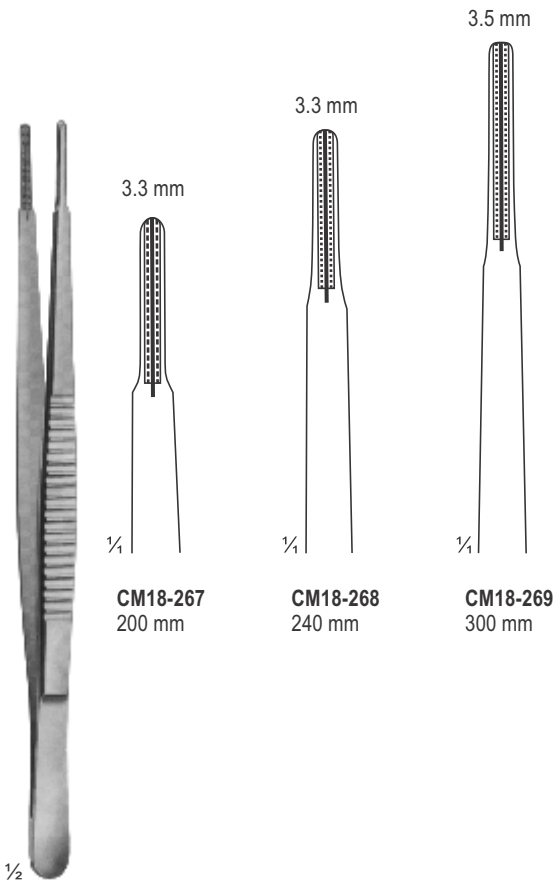

CM18-267 - CM18-269
DE BAKEY

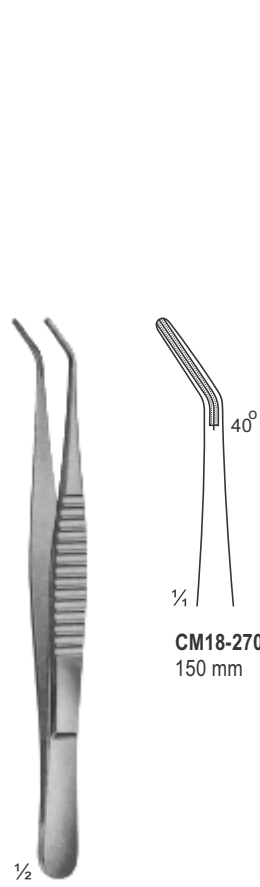

CM18-270
DE BAKEY

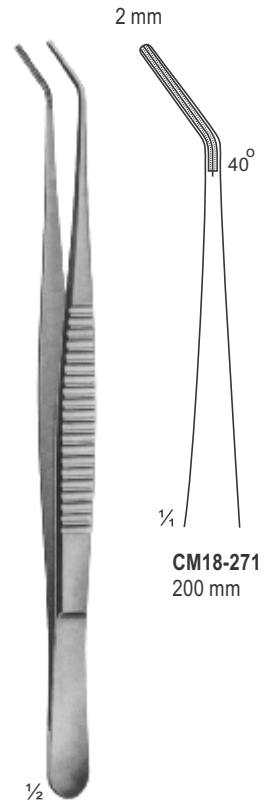

CM18-271
DE BAKEY

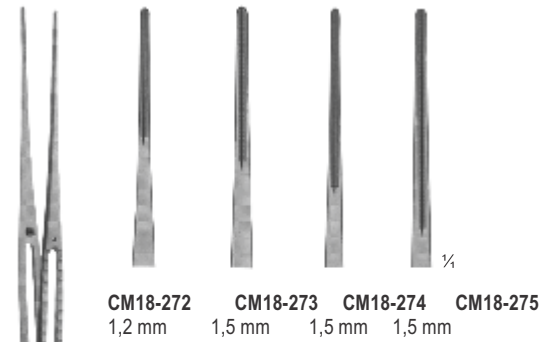

CM18-272 1,2 mm
CM18-273 1,5 mm
CM18-274 1,5 mm
CM18-275 1,5 mm

1/2

CM18-272 150 mm
CM18-273 200 mm
CM18-274 240 mm
CM18-275 300 mm



CM18-276 2 mm
CM18-277 2 mm
CM18-278 2 mm
CM18-279 2 mm

1/2

DE BAKEY
CM18-276 150 mm
CM18-277 200 mm
CM18-278 240 mm
CM18-279 300 mm

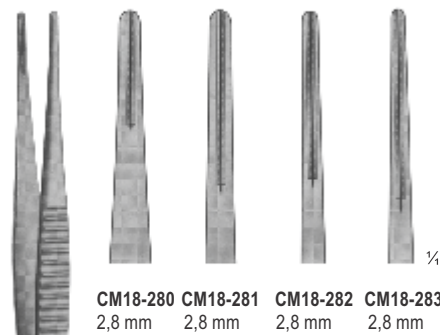

CM18-280 2,8 mm
CM18-281 2,8 mm
CM18-282 2,8 mm
CM18-283 2,8 mm

1/2

DE BAKEY
CM18-280 150 mm
CM18-281 200 mm
CM18-282 240 mm
CM18-283 300 mm

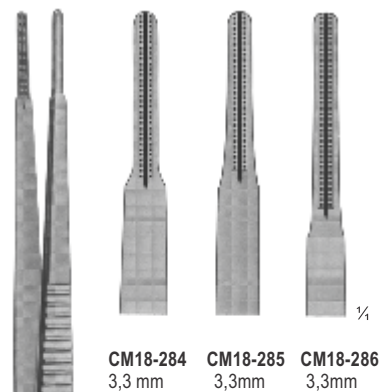

CM18-284 3,3 mm
CM18-285 3,3 mm
CM18-286 3,3 mm

1/2

DE BAKEY
CM18-284 200 mm
CM18-285 240 mm
CM18-286 300 mm

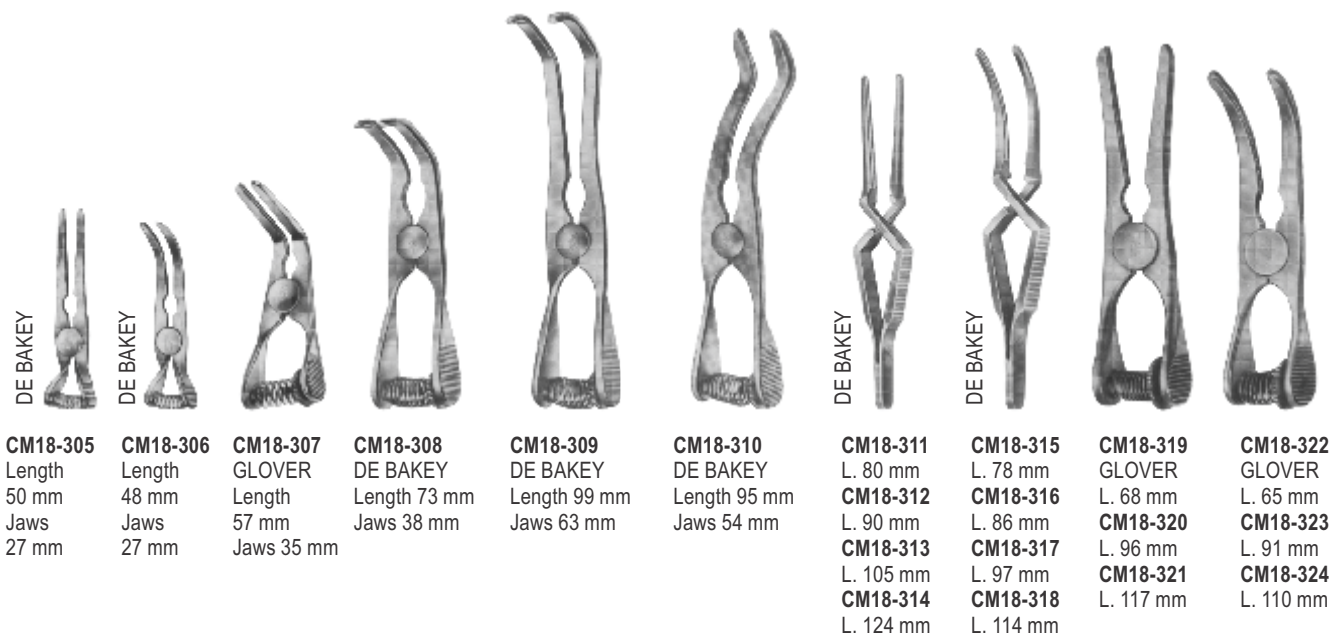
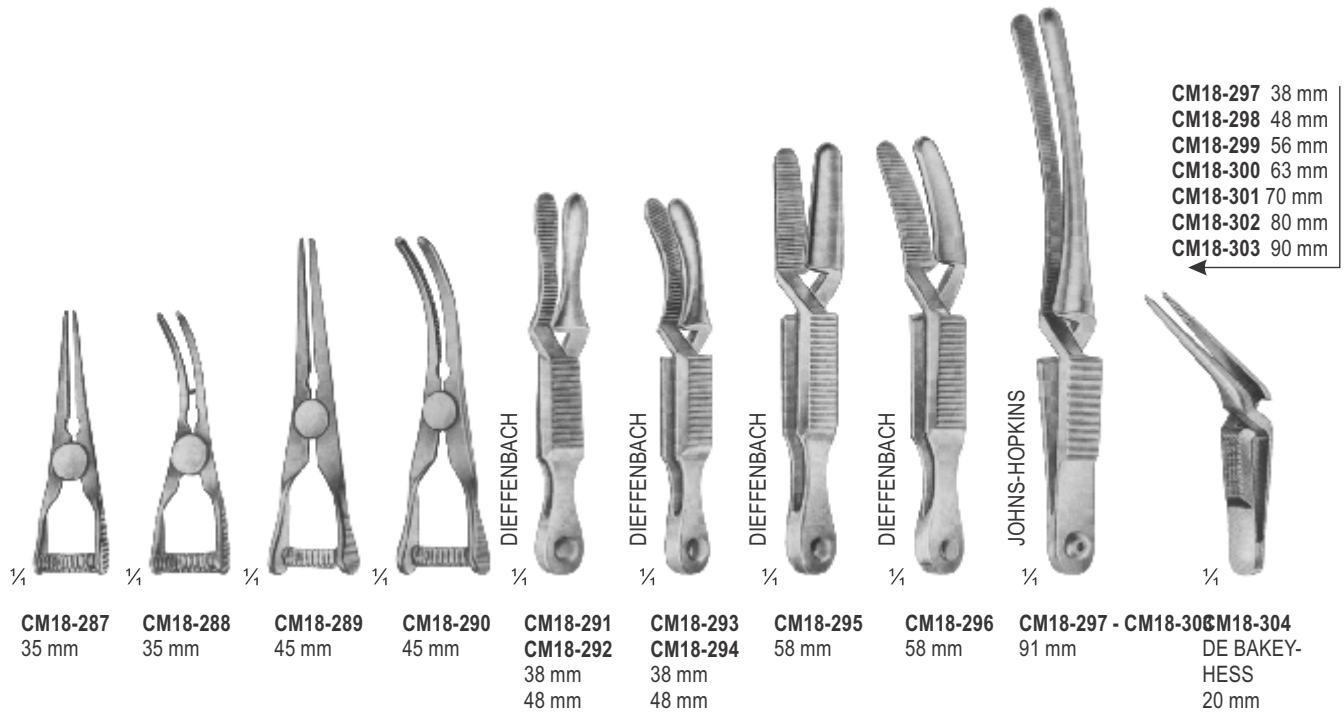

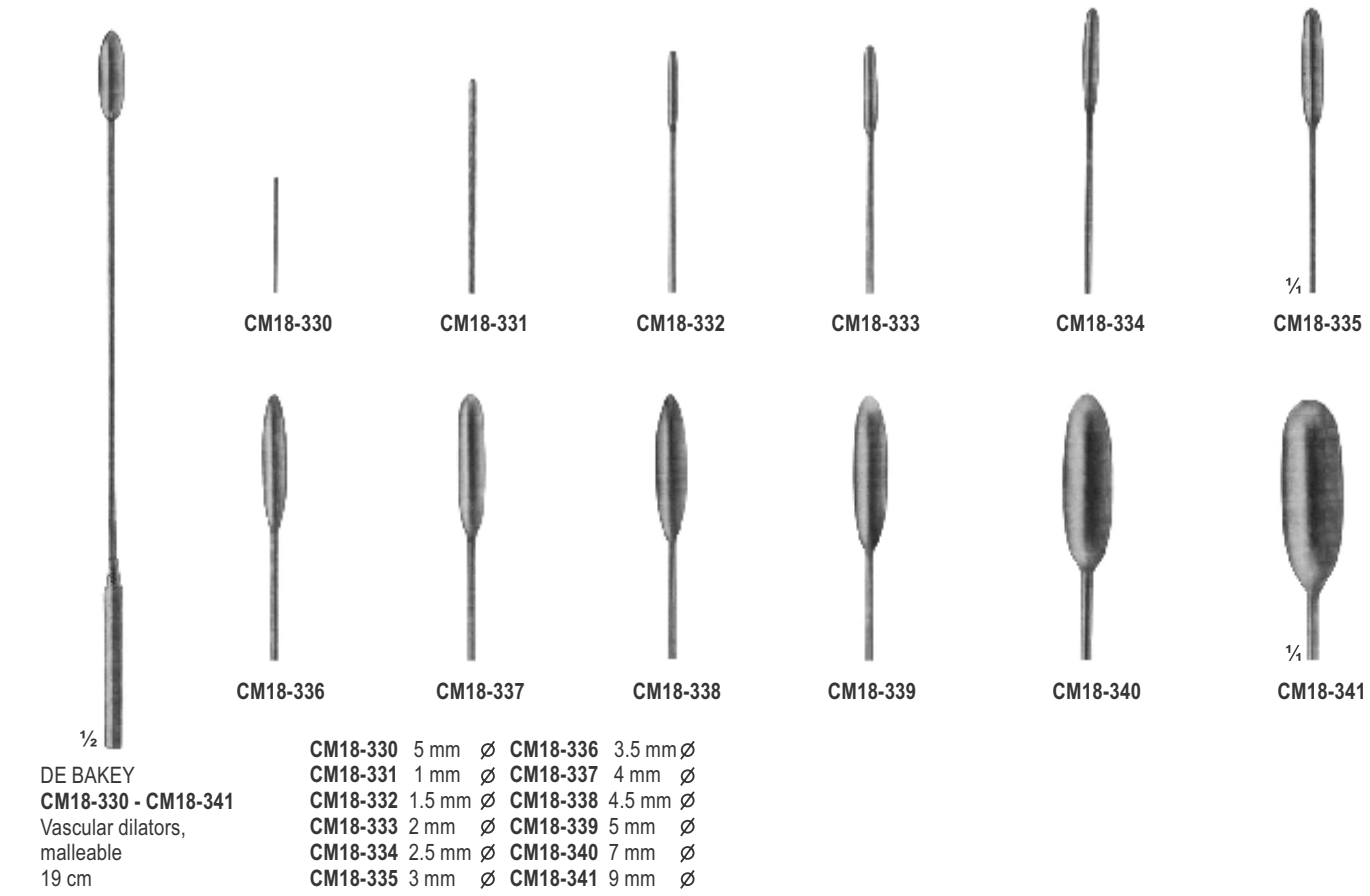
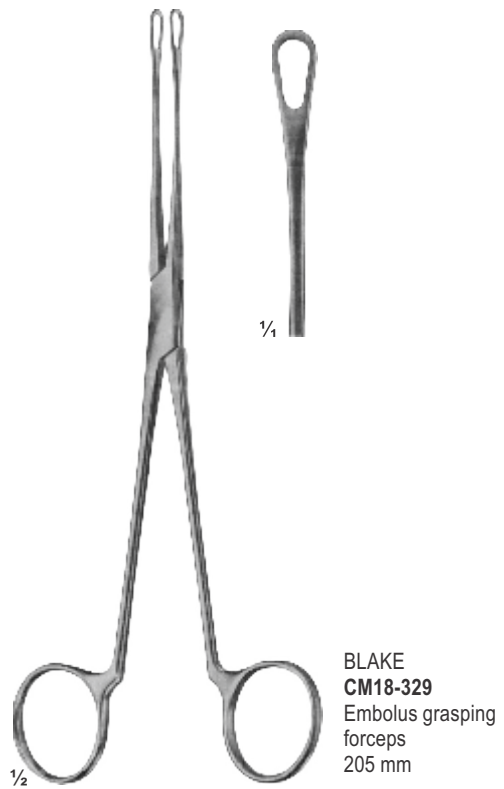
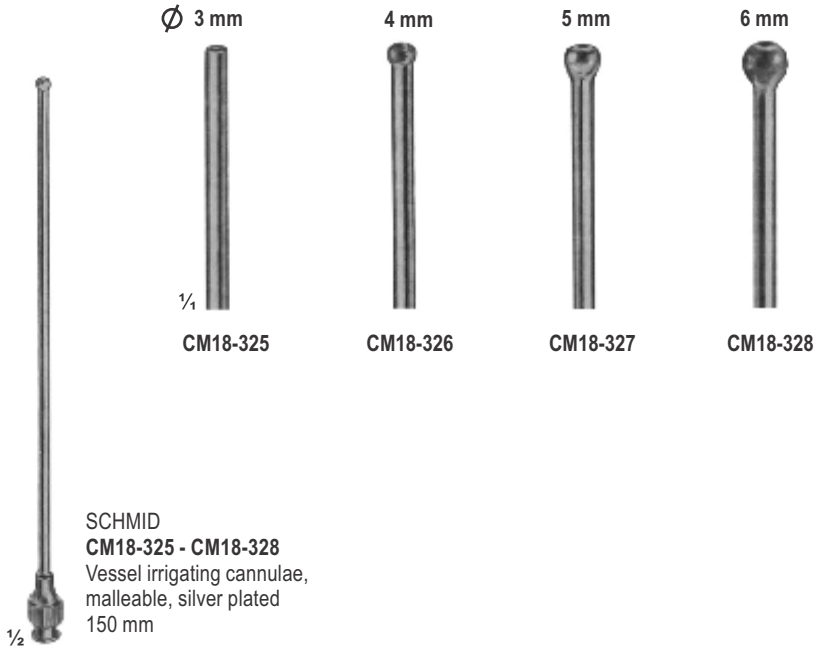

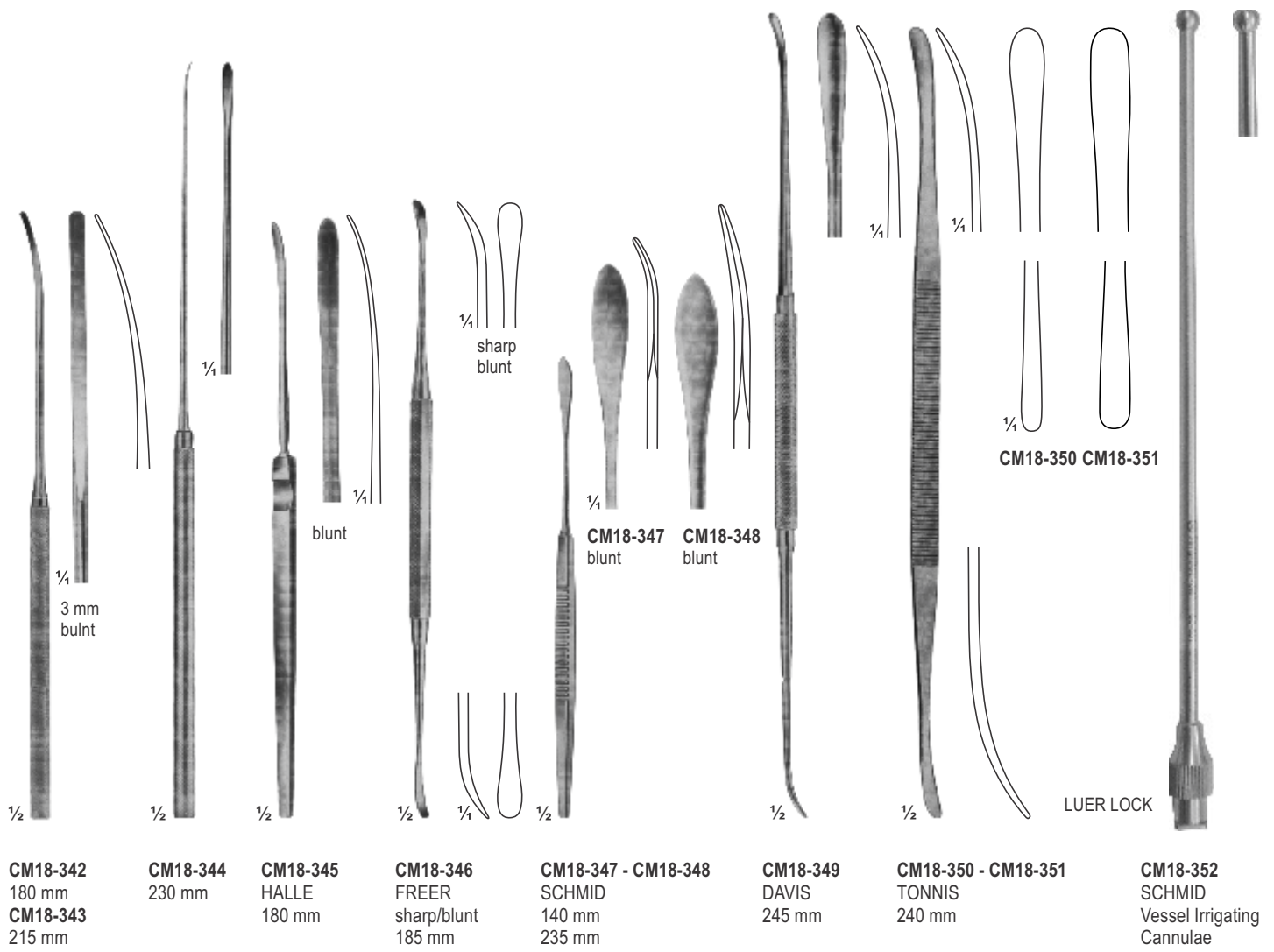

CM18-342
180 mm
CM18-343
215 mm

CM18-344
230 mm

CM18-345
HALLE
180 mm

CM18-346
FREER
sharp/blunt
185 mm

CM18-347 - CM18-348
SCHMID
140 mm
235 mm

CM18-349
DAVIS
245 mm

CM18-350 - CM18-351
TONNIS
240 mm

CM18-352
SCHMID
Vessel Irrigating
Cannulae
150 mm, 6"
3, 4, 5, 6 mm

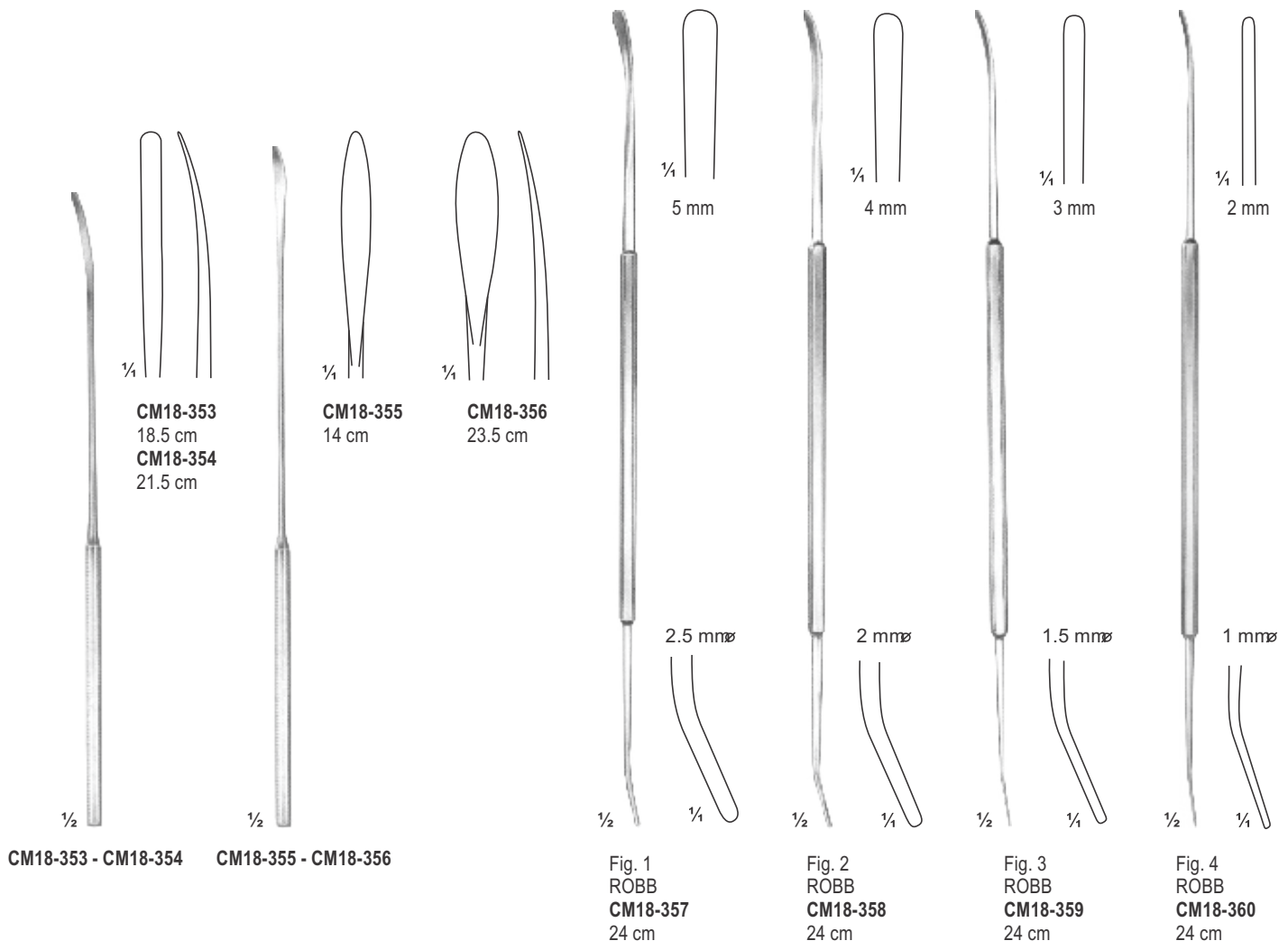



CRILE
CM18-361
20 cm



CRILE
CM18-362
20.5 cm



CM18-363 - CM18-366
26 cm



CM18-363
1.5 mm Ø



CM18-364
2 mm Ø



CM18-365
2.5 mm Ø



CM18-366
3 mm Ø



CM18-367
2 mm



CM18-368
3 mm



CM18-369
5 mm



CM18-370
6 mm



CM18-371
7 mm



CM18-372
8.5 mm

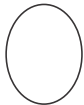

CM18-373
10 mm

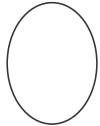

CM18-374
12 mm

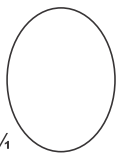

CM18-375
14mm



1/4

CM18-367 - CM18-375
Endarterectomy strippers
55 cm



1/2

CM18-376
Handle for
11 cm

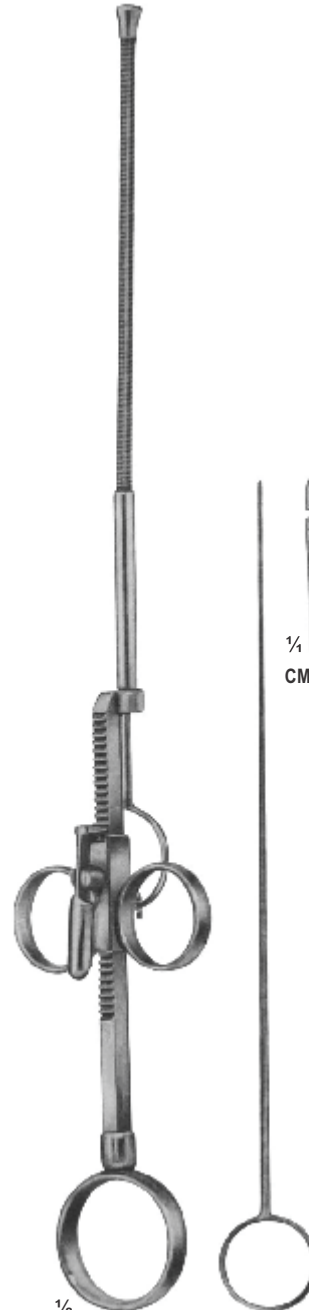

1/2

RUMEL-BELBONT
CM18-377 - CM18-378
32.5 cm
CM18-377 - 4 mm Ø
CM18-378 - 6.4 mm Ø



1/4

CM18-379 CM18-380

CM18-379 - CM18-380
Guide only

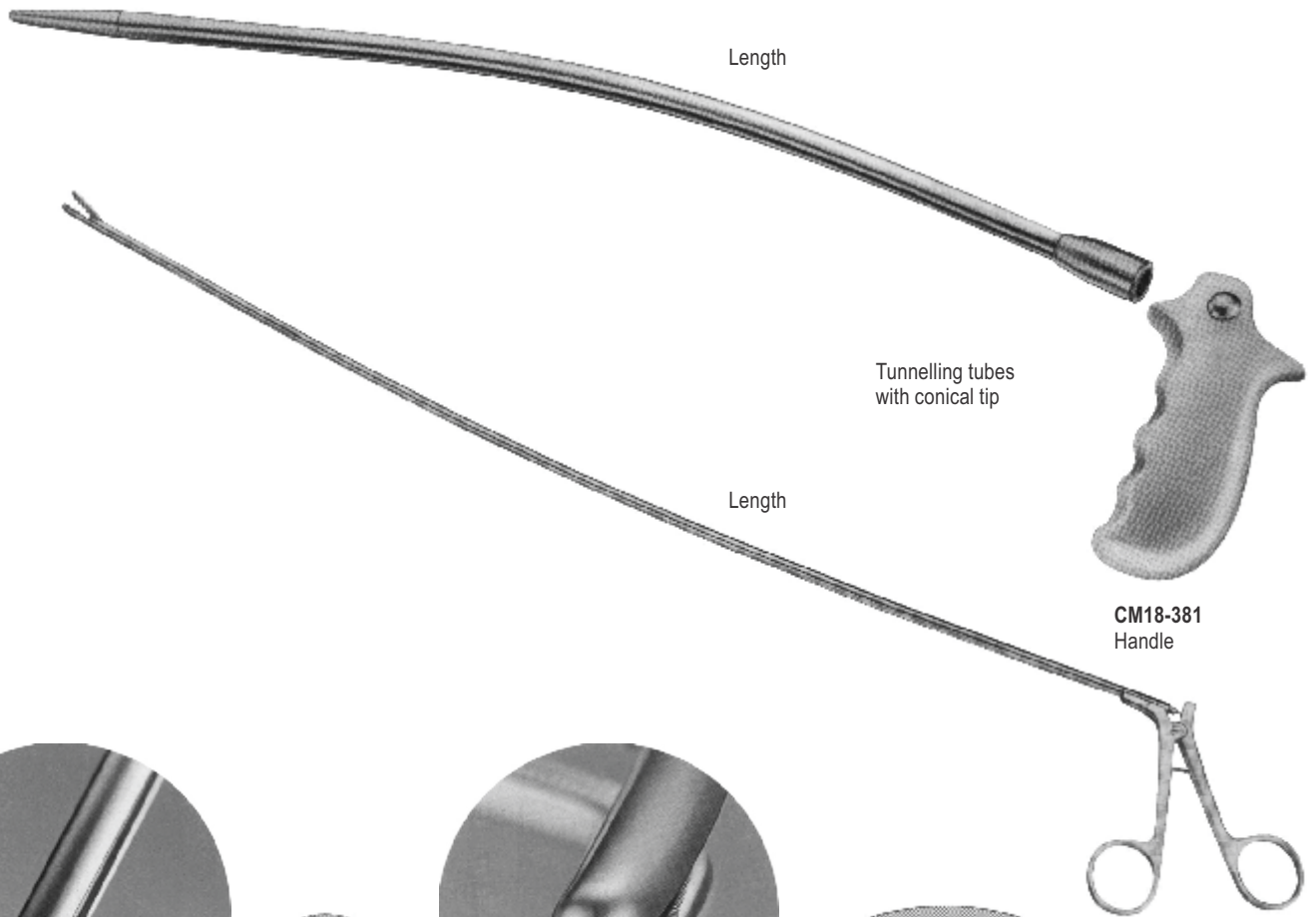

CM18-381
Handle

CM18-382 - CM18-385
Forceps

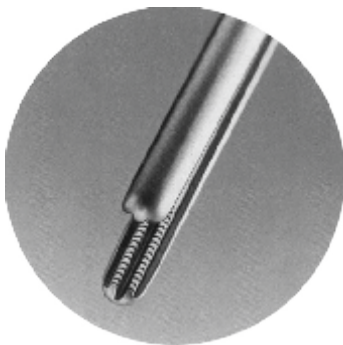

DE BAKEY
CM18-382
1 : 2 rows of teeth



DE BAKEY
CM18-383
2 : 3 rows of teeth

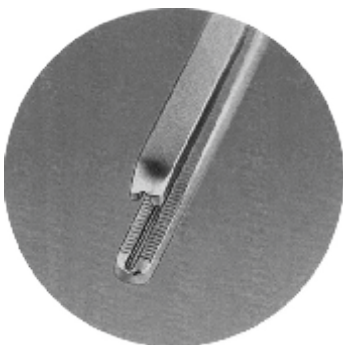
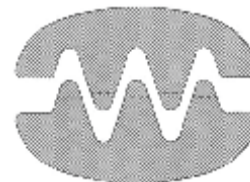

COOLEY
CM18-384
2 : 2 rows of teeth

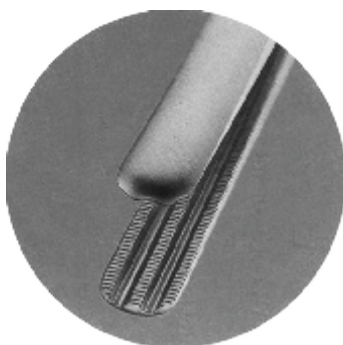

DARDIK
CM18-385
2 : 3 rows of teeth



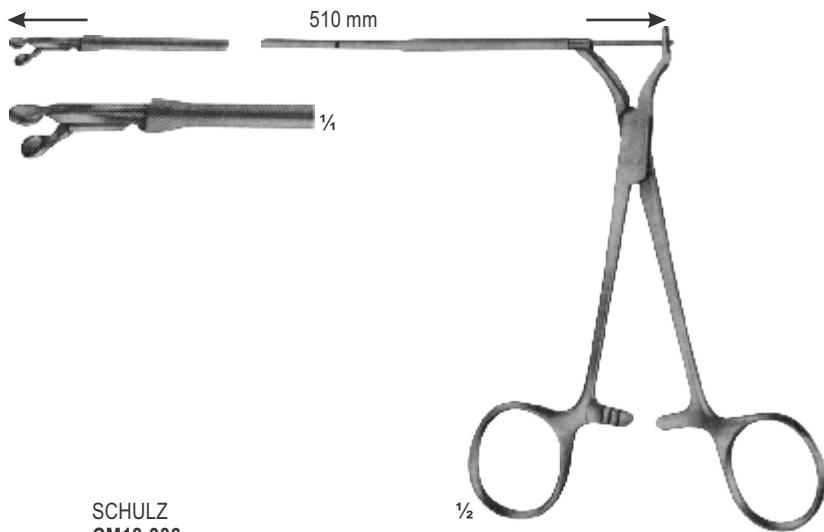

**SCHULZ
CM18-386**
Bioptome, mit flexiblem Schaft, 510 mm lang,
with round jaws 3 mm diam.

Biopsy forceps, for biopsy from the right atrium
through cava juglaris, prior to heart implantations.

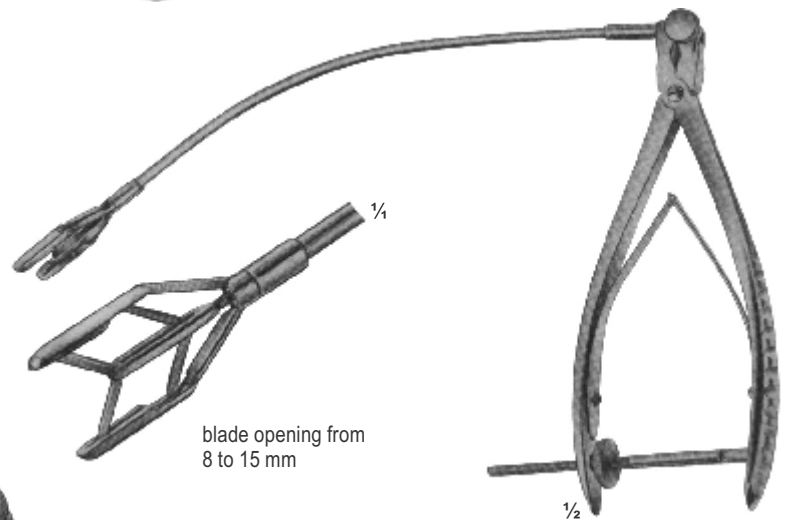

**COOLEY
CM18-387**
Dilator for mitral valve
for children

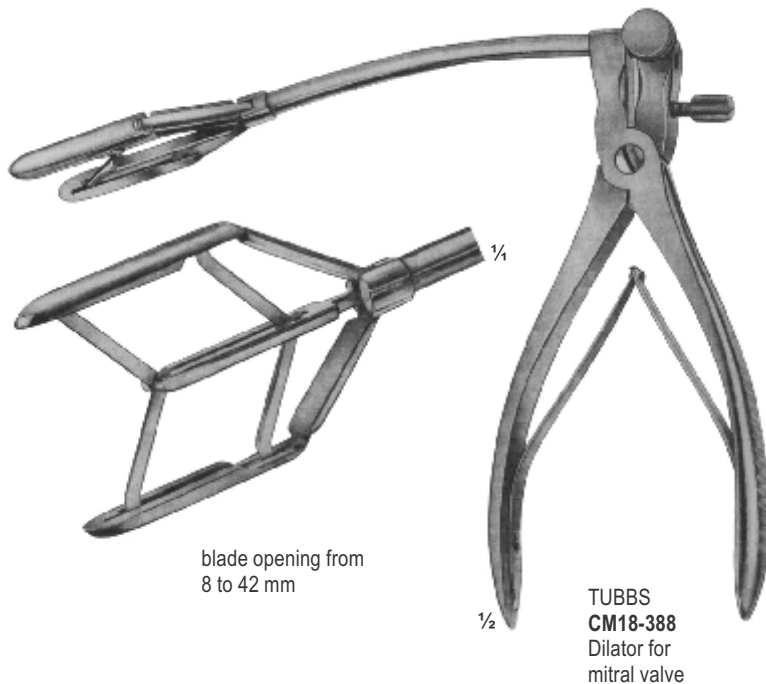

**TUBBS
CM18-388**
Dilator for mitral valve

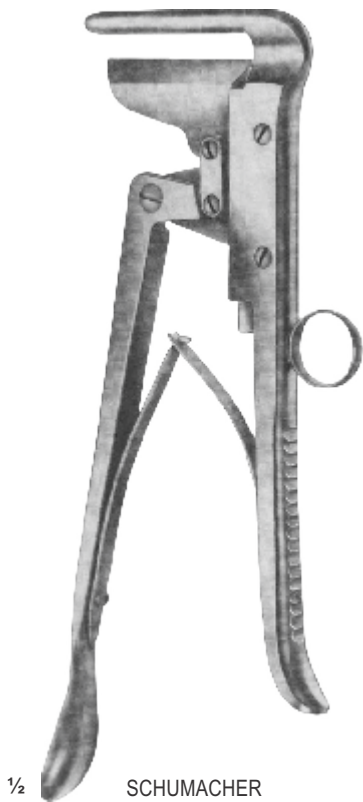

1/2 SCHUMACHER
Sternum shears
CM18-389
210 mm



1/3 GIERTZ-STILLE
CM18-390
250 mm



1/2 GLUCK
CM18-391
190 mm

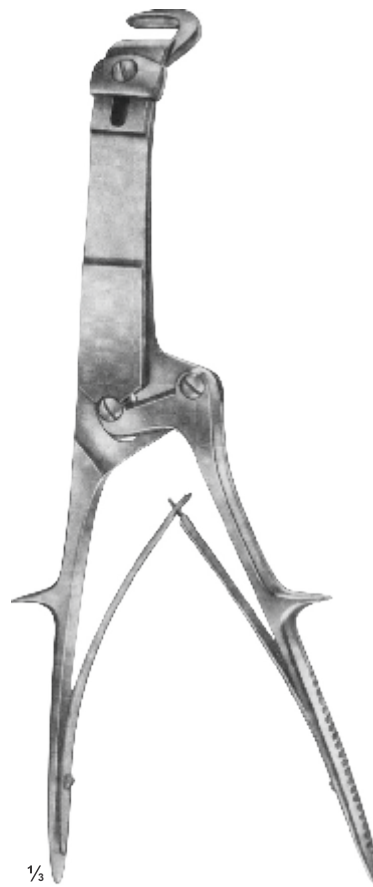

1/3 BRUNNER
Universal Pattern
CM18-392
340 mm



CM18-393
SEMB
Rib-and Bone
Holding forceps
190 mm



CM18-394
SEMB
Rib-and Bone
Holding forceps
190 mm

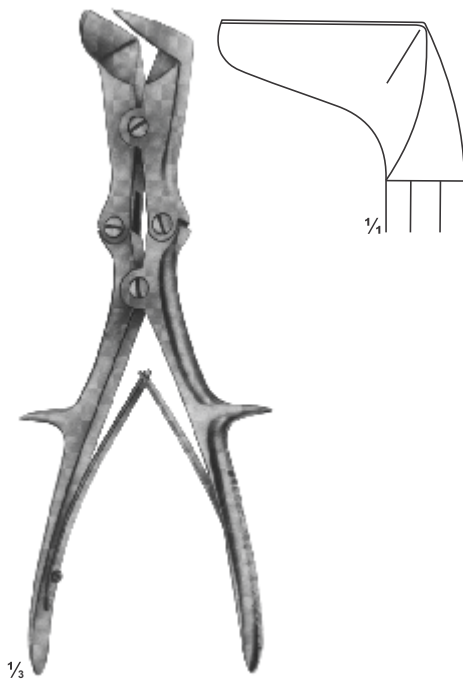

CM18-395
LISTON-STILLE
265 mm

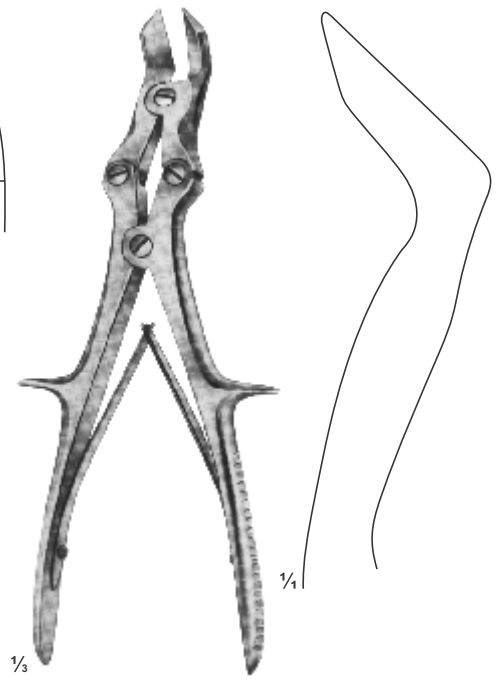

CM18-396
LISTON-KEY-HORSLEY
255 mm

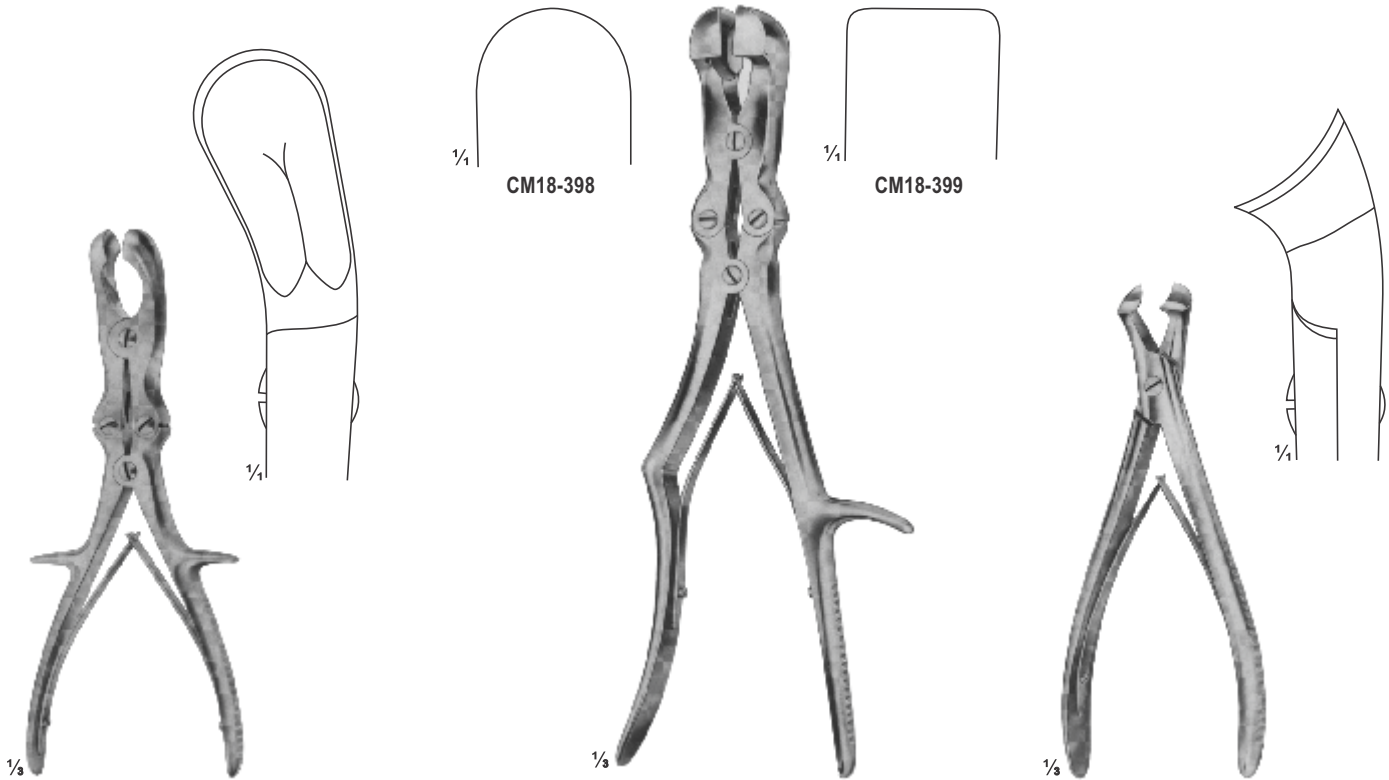

CM18-397
SEME
Rib Rongeur to shorten
the rib stumps
240 mm

CM18-398 - CM18-399
SAUERDRÜCH-CORYLLOS
Rib rongeurs to shorten
the rib stumps
310 mm

CM18-400
MARKWALDER
Rib Rongeur to Round
the rib stumps
190 mm

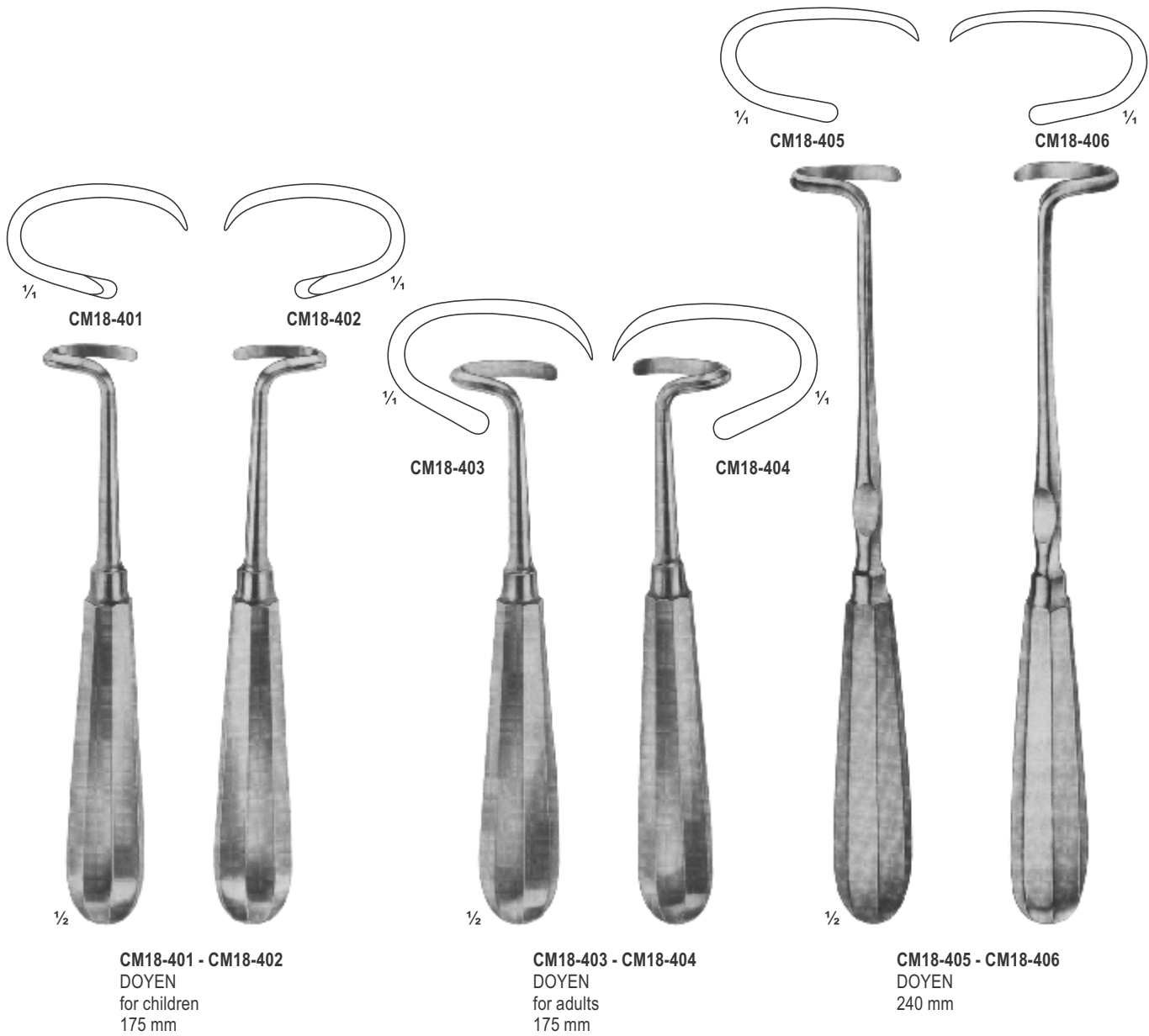

CM18-401 - CM18-402
DOYEN
for children
175 mm

CM18-403 - CM18-404
DOYEN
for adults
175 mm

CM18-405 - CM18-406
DOYEN
240 mm

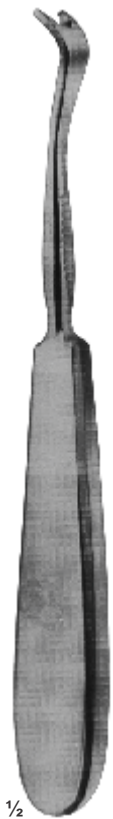

1/2
CM18-407 - CM18-411
SEMB
230 mm

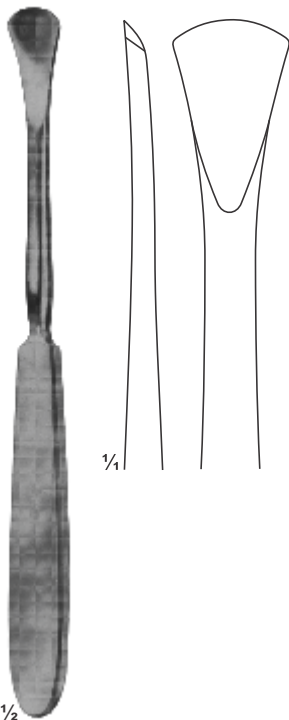
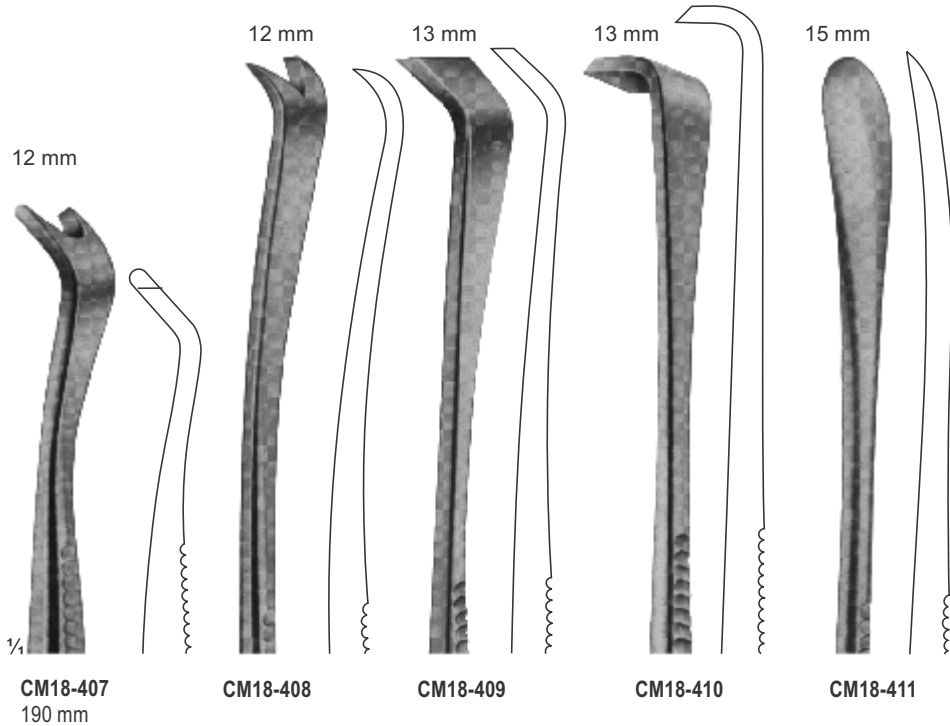

1/2
CM18-412
LANGENBECK
190 mm

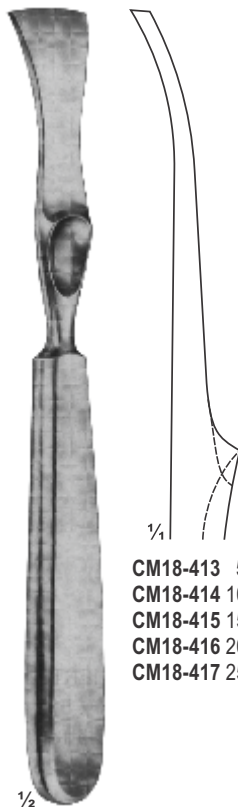

1/2
CM18-413 - CM18-417
LAMBOTTE
215 mm

- CM18-413** 5 mm
- CM18-414** 10 mm
- CM18-415** 15 mm
- CM18-416** 20 mm
- CM18-417** 25 mm

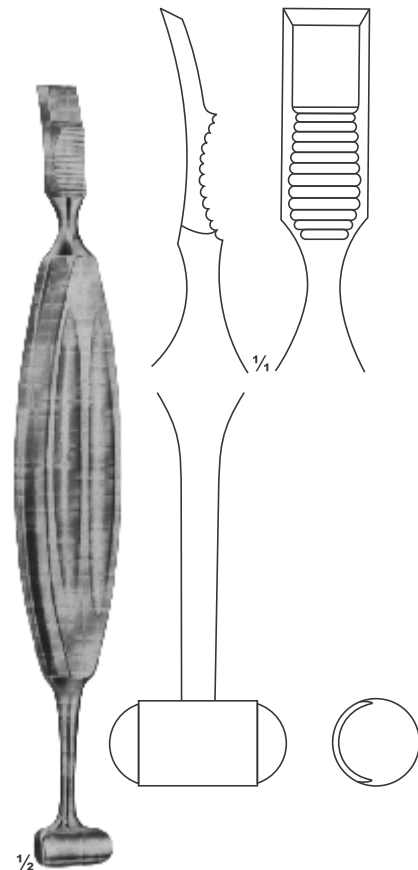

1/2
CM18-418
ALEXANDER
210 mm



CARE MEDICAL[®]
SUPPLIES

Your health _ Our Priority

Section

19

Page 366-384

Wire Saws And Conductor
Skull Traction Tongs
Clips And Applying Forceps
Amputation Saws
Cranial Rongeurs
Bone Hand Drills
Rongeurs
Punches

PUNCHES

90° upwards cutting

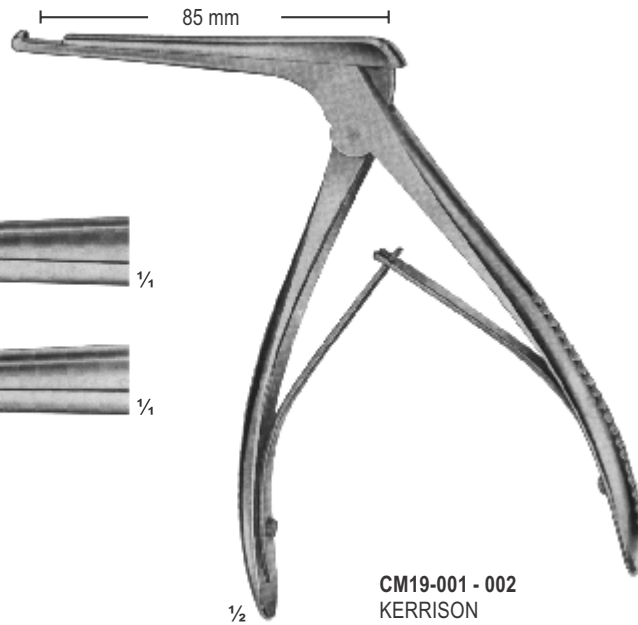

CM19-001
4 mm



CM19-002
5 mm



CM19-001 - 002
KERRISON

90° upwards cutting

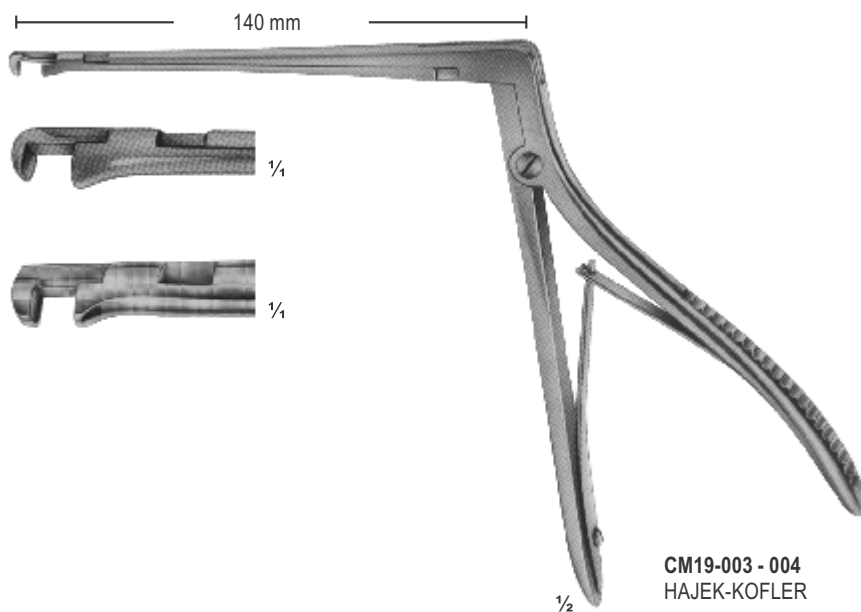

CM19-003
3,3 mm



CM19-004
4,0 mm



CM19-003 - 004
HAJEK-KOFLER

PUNCHES

130°

upwards cutting

140 mm

CM19-005
1 mm



CM19-006
2 mm



CM19-007
3 mm



CM19-008
4 mm

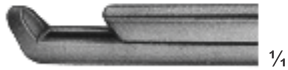

CM19-009
5 mm



CM19-005 - 009
KERRISON-JACOBY

90°

upwards cutting

180 mm

CM19-010
1 mm



CM19-011
2 mm



FERRIS-SMITH-KERRISON

CM19-012
3 mm

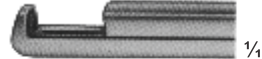

CM19-013
4 mm



CM19-014
5 mm



CM19-010 - 014
KERRISON-JACOBY

RONGEURS

Angled positions for rongeurs

CM19-015
3,0 mm

CM19-016
3,6 mm

CM19-017
4,2 mm

CM19-018
4,8 mm

CM19-019
5,8 mm

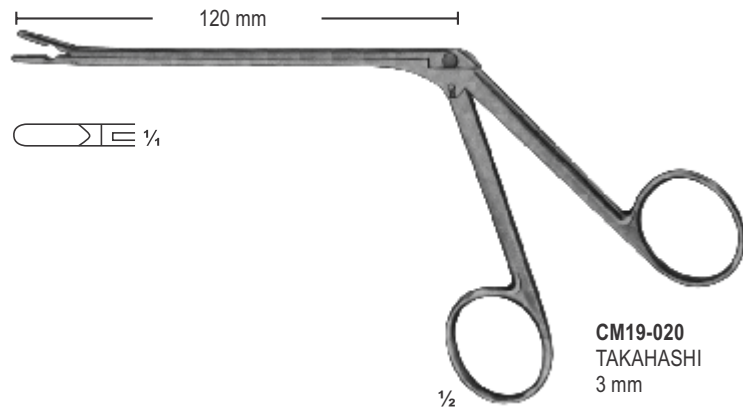
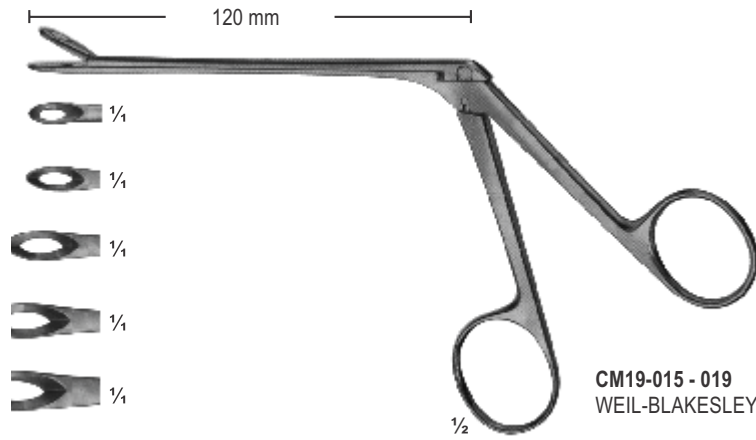

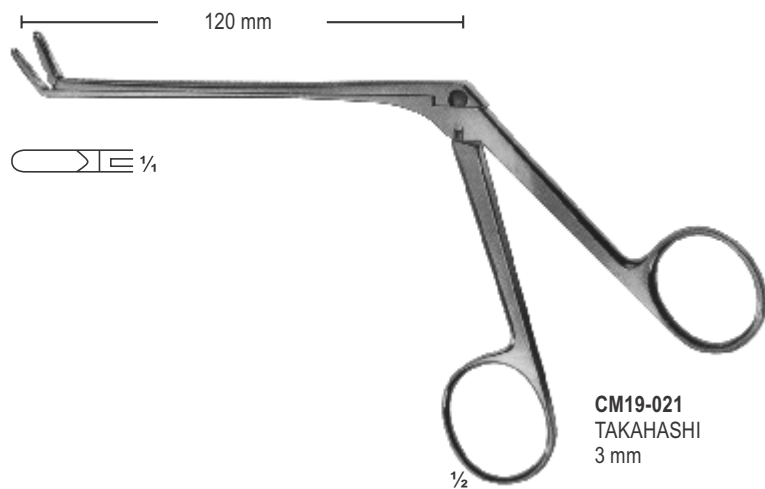

130°

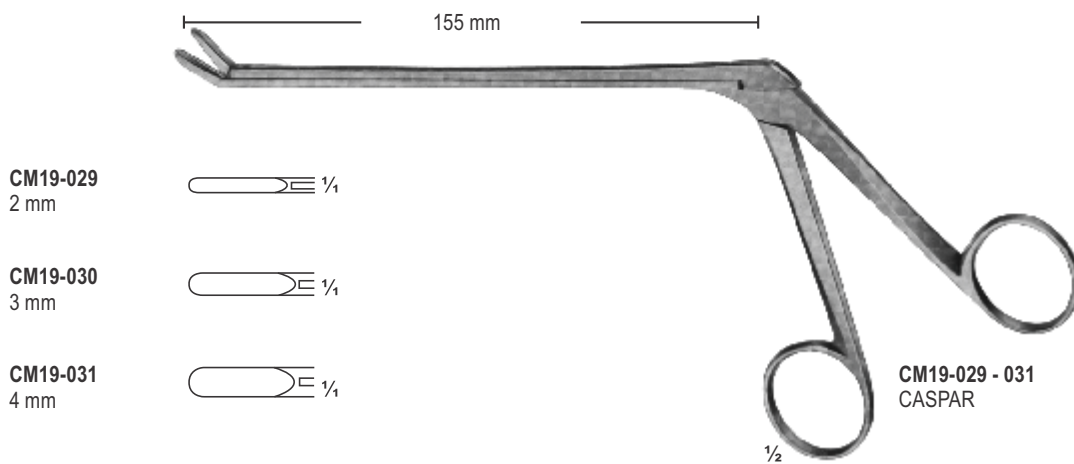
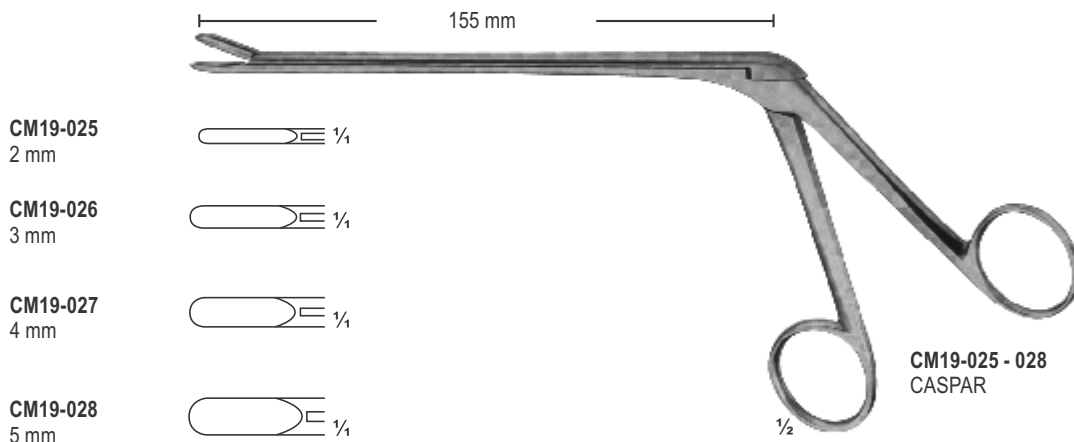
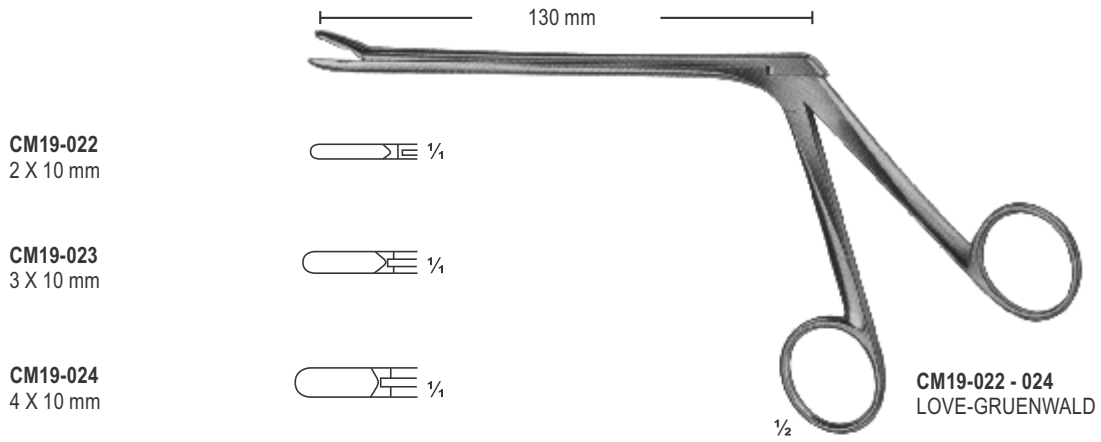

RONGEURS



RONGEURS

Length of shaft 140 mm	Length of shaft 160 mm	Length of shaft 185 mm	size of jaws
CM19-032	CM19-034	CM19-036	3 X12 mm  1/4
CM19-033	CM19-035	CM19-037	4 X14 mm  1/4

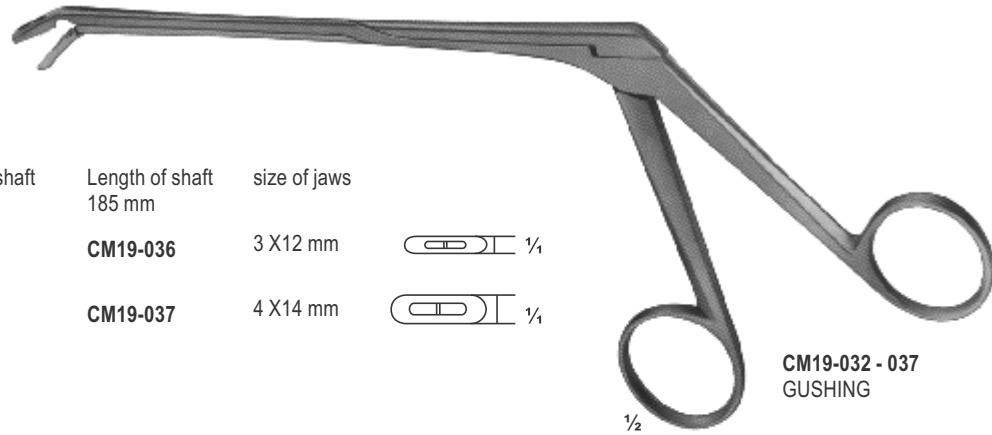

CM19-038
2 X 10 mm
GUSHING

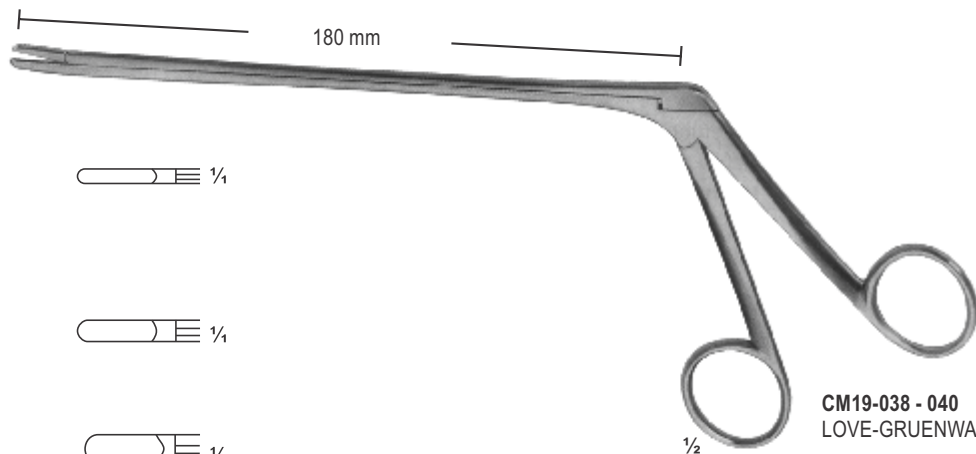

CM19-039
3 X 10 mm
LOVE-GRUENWALD

CM19-040
4 X 10 mm
SPURLING

CM19-041
3 X 10 mm
LOVE-GRUENWALD

CM19-042
4 X 10 mm
SPURLING

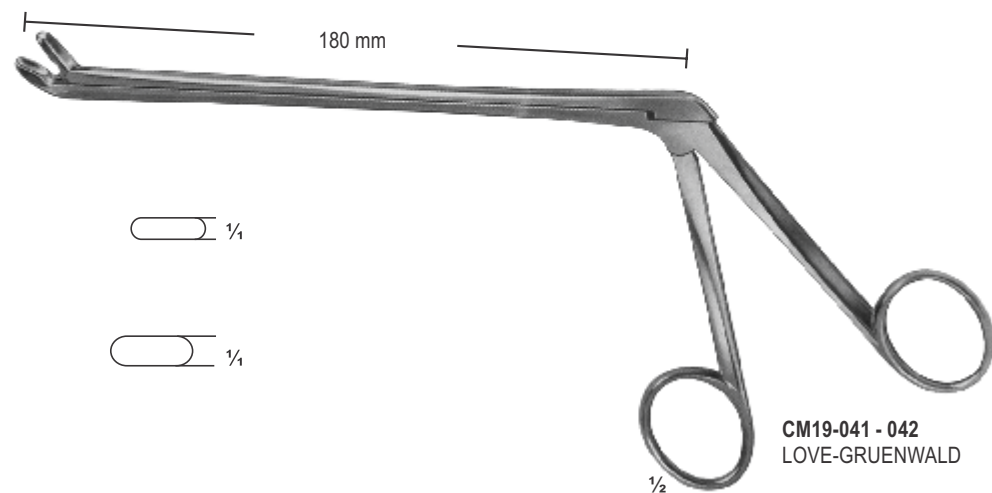

RONGEURS

CM19-043
3 X 10 mm
LOVE-GRUENWALD



CM19-044
4 X 10 mm
SPURLING

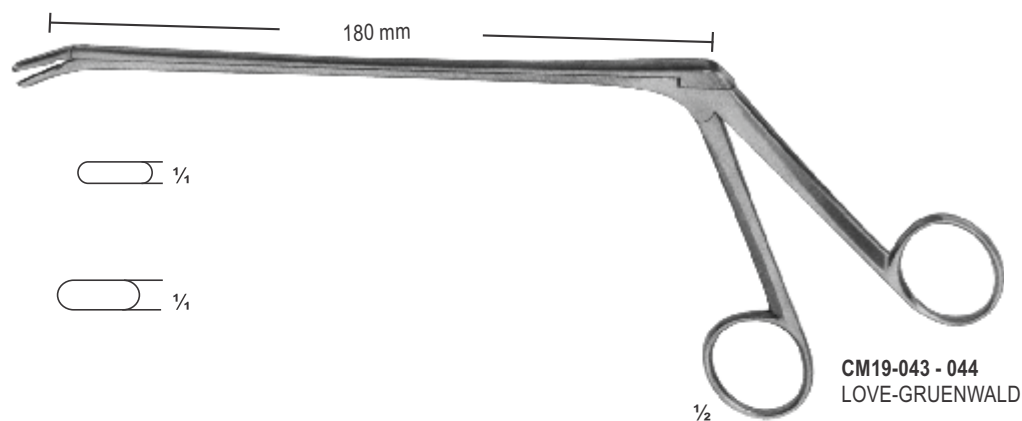

CM19-043 - 044
LOVE-GRUENWALD

CM19-045
7 mm

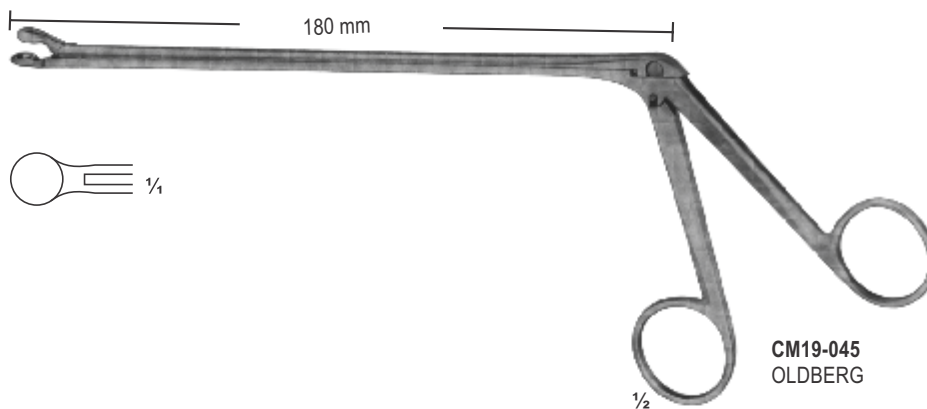
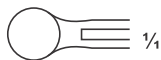

CM19-045
OLDBERG

CM19-046
YASARGIL
2,2 mm



CM19-047
YASARGIL
3,5 mm

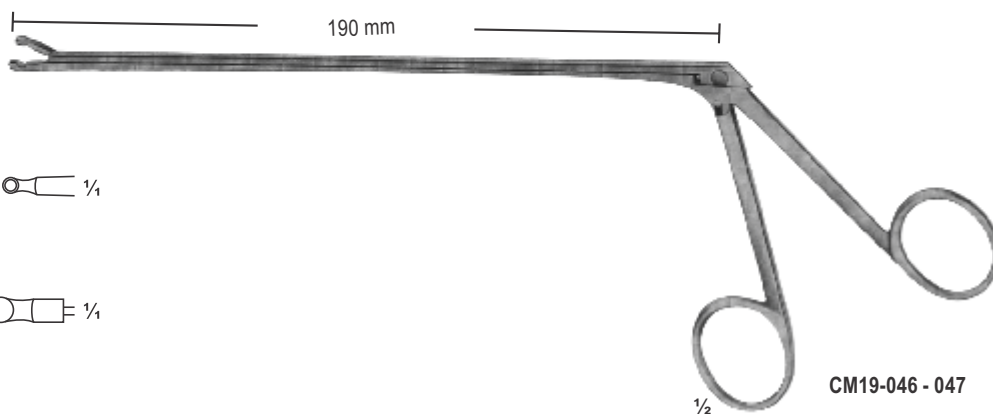

CM19-046 - 047

RONGEURS

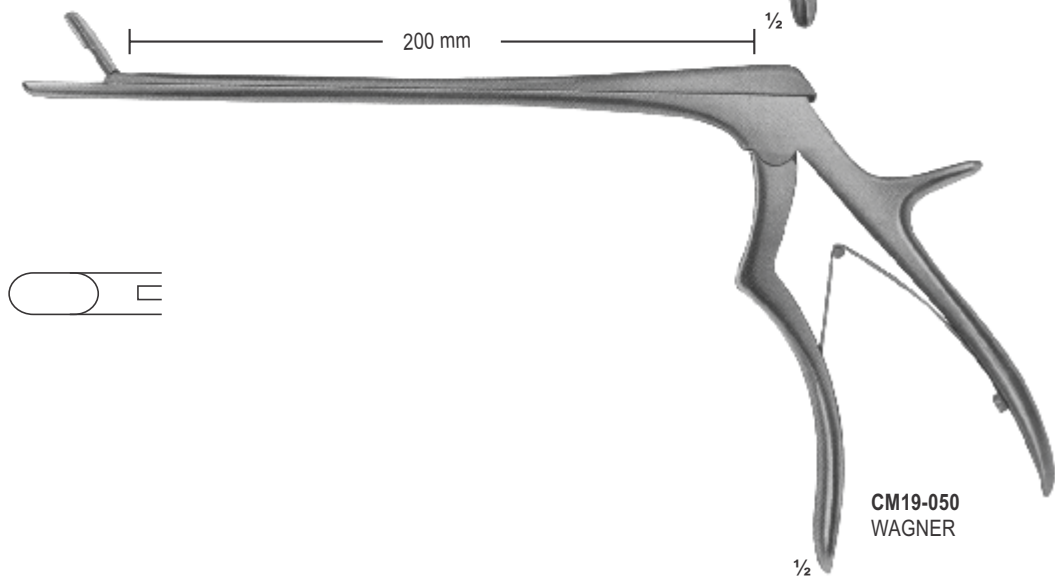
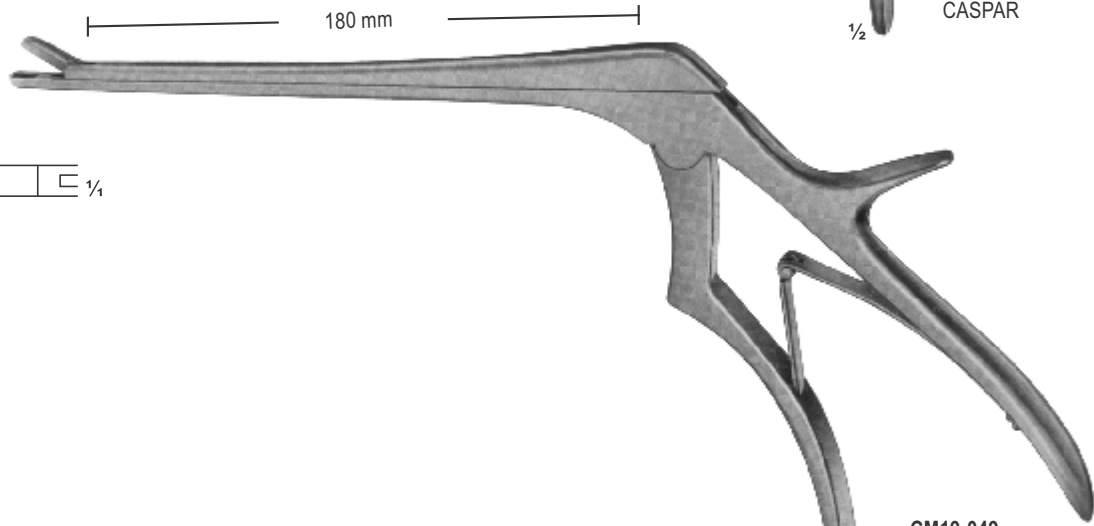
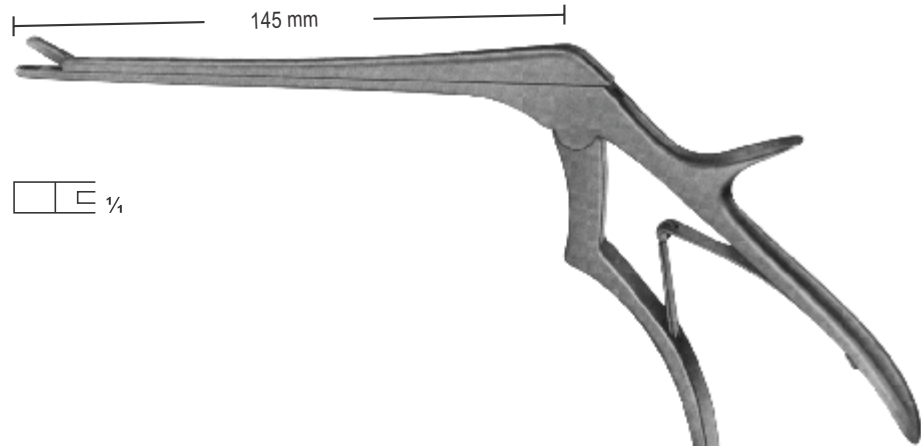

PUNCHES

90° upwards cutting

85 mm

CM19-051
4 mm



1/4

CM19-052
5 mm



1/4

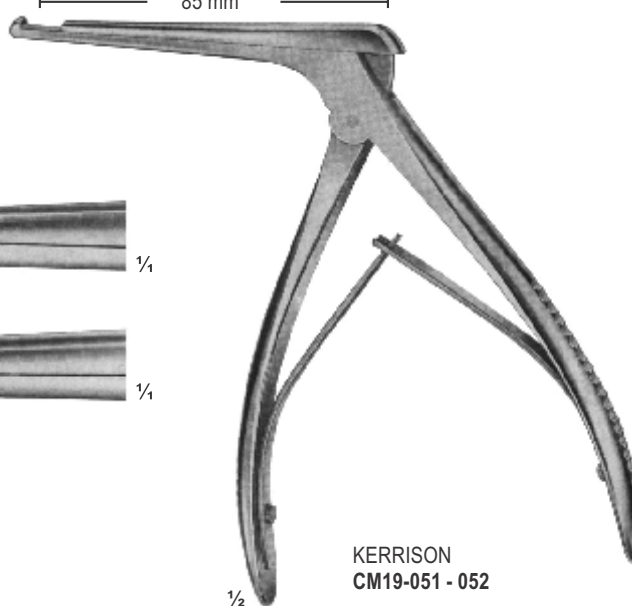

KERRISON
CM19-051 - 052

90° upwards cutting

140 mm

CM19-053
3.3 mm



1/4

CM19-054
4 mm



1/4

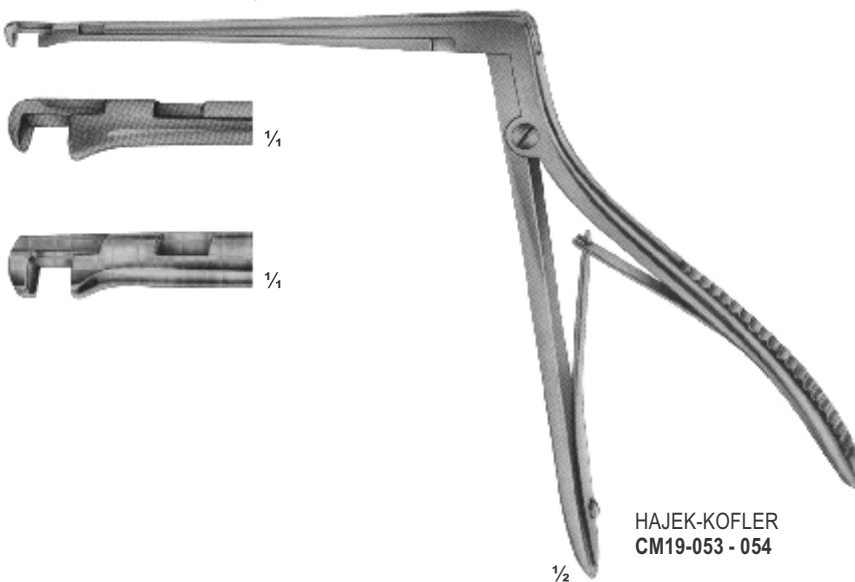

HAJEK-KOFLER
CM19-053 - 054

PUNCHES

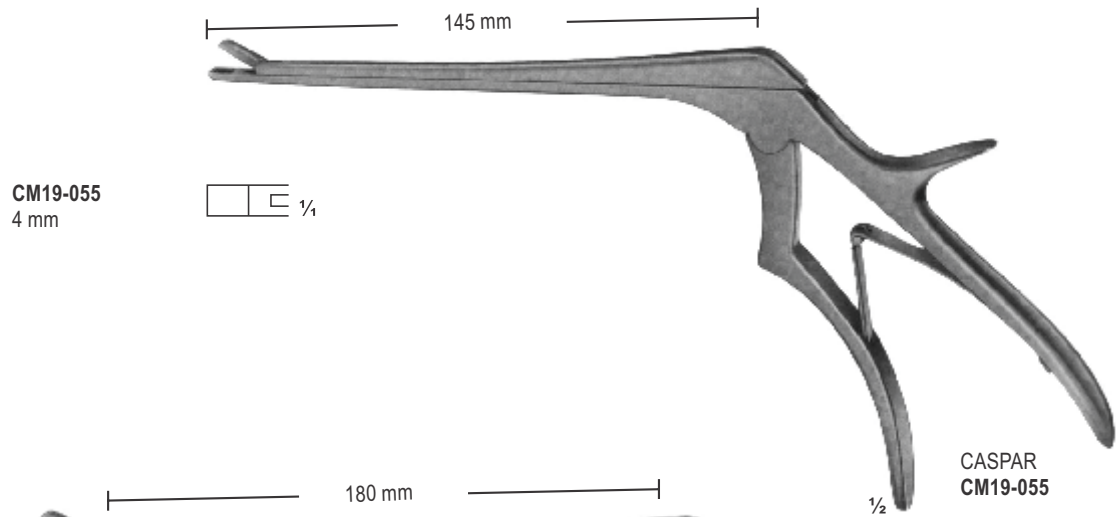

CM19-055
4 mm



CASPAR
CM19-055

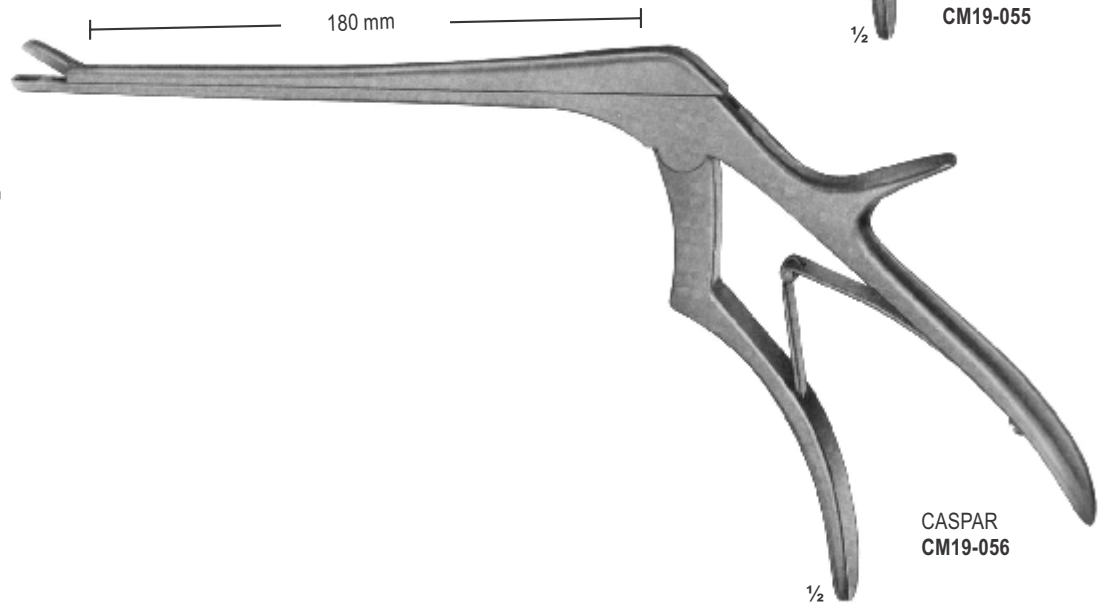

CM19-056
4 mm



CASPAR
CM19-056

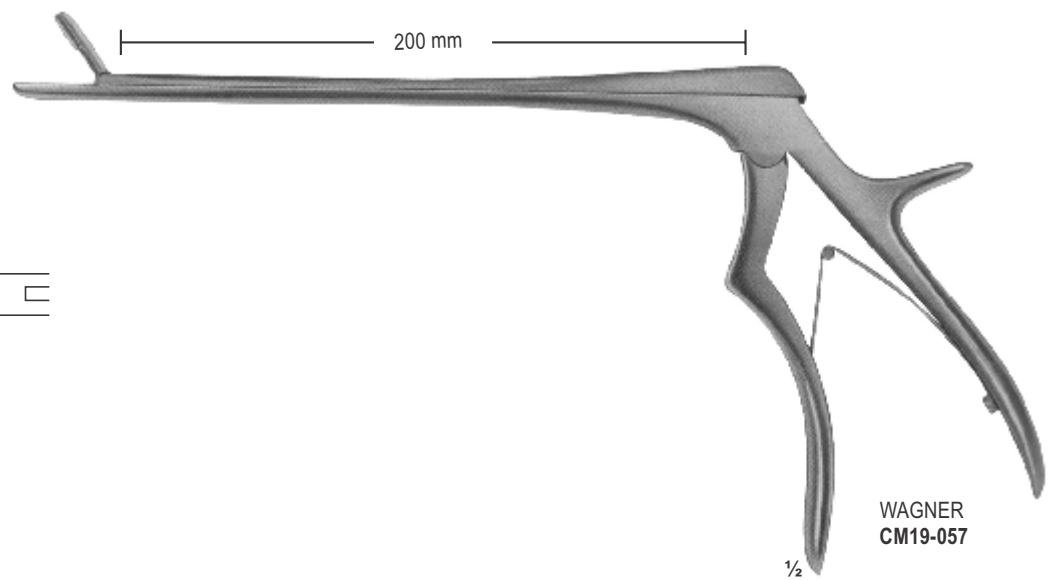

CM19-057
5.5 mm



WAGNER
CM19-057

PUNCHES

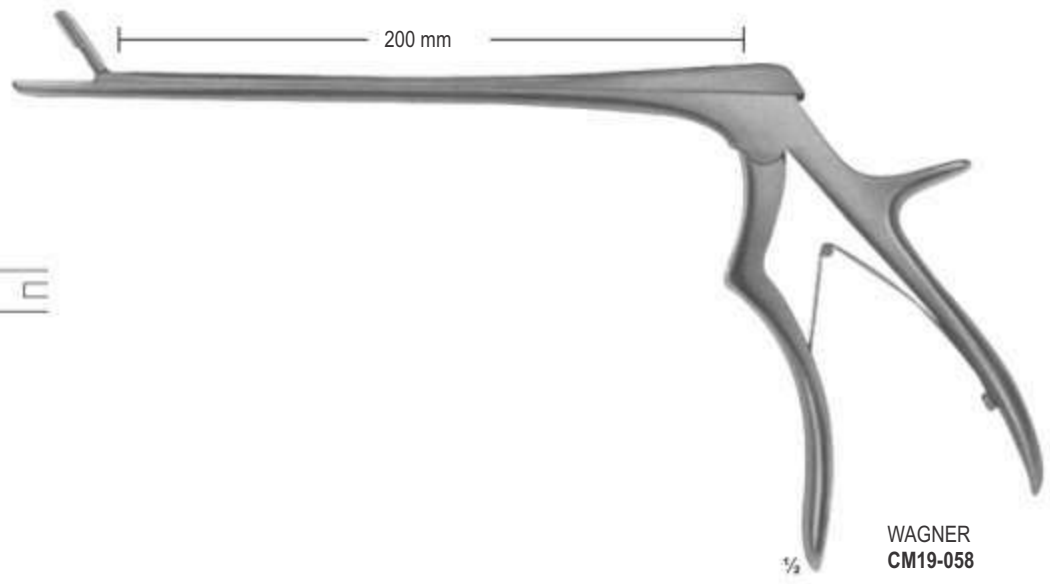

CM19-058
5.5 mm



AMPUTATION SAWS

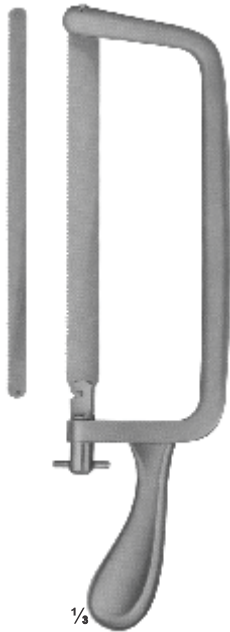

CM19-059
CHARRIER
Length of blade
215 mm
complete with one saw
blade each
350 mm
Spare saw blades, carbon steel
CM19-060 12 mm
CM19-061 20 mm

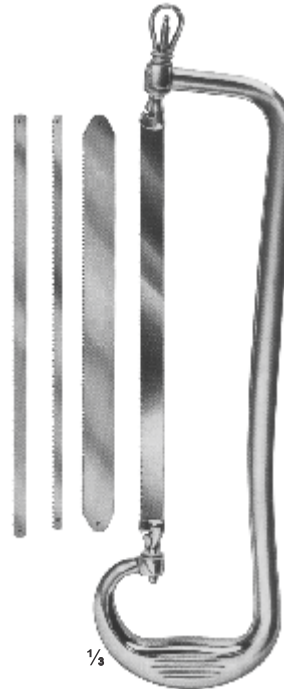

CM19-062
RUST
Length of blade
235 mm
complete with one saw
blade each
390 mm
CM19-063 Bow only
Spare saw blades, carbon steel
CM19-064 6 mm
CM19-065 12 mm
CM19-066 20 mm

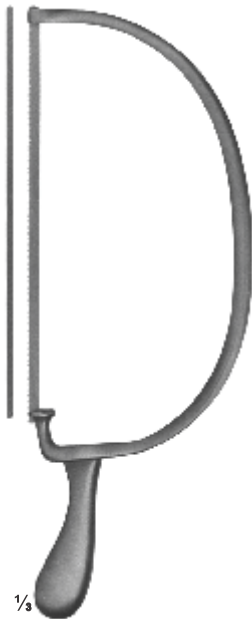

CM19-067
BIER
Length of blade
270 mm
complete with one saw
blade each
420 mm
Spare saw blades, carbon steel
CM19-068 4 mm
CM19-069 6 mm
CM19-070 8 mm

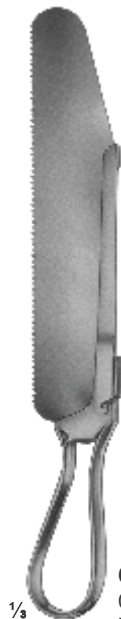

CM19-071
CHARRIERE
Length of blade
180 mm
Spare saw blades,
carbon steel
270 mm
CM19-072
CHARRIERE
Length of blade
240 mm
Spare saw blades,
carbon steel
340 mm



CM19-073
SATTLERLEE
Length of blade
200 mm
Spare saw blades,
carbon steel
290 mm



CM19-074
LANGENBECK
Length of blade
115 mm
Metacarpal saw
235 mm

WIRE SAWS AND CONDUCTOR

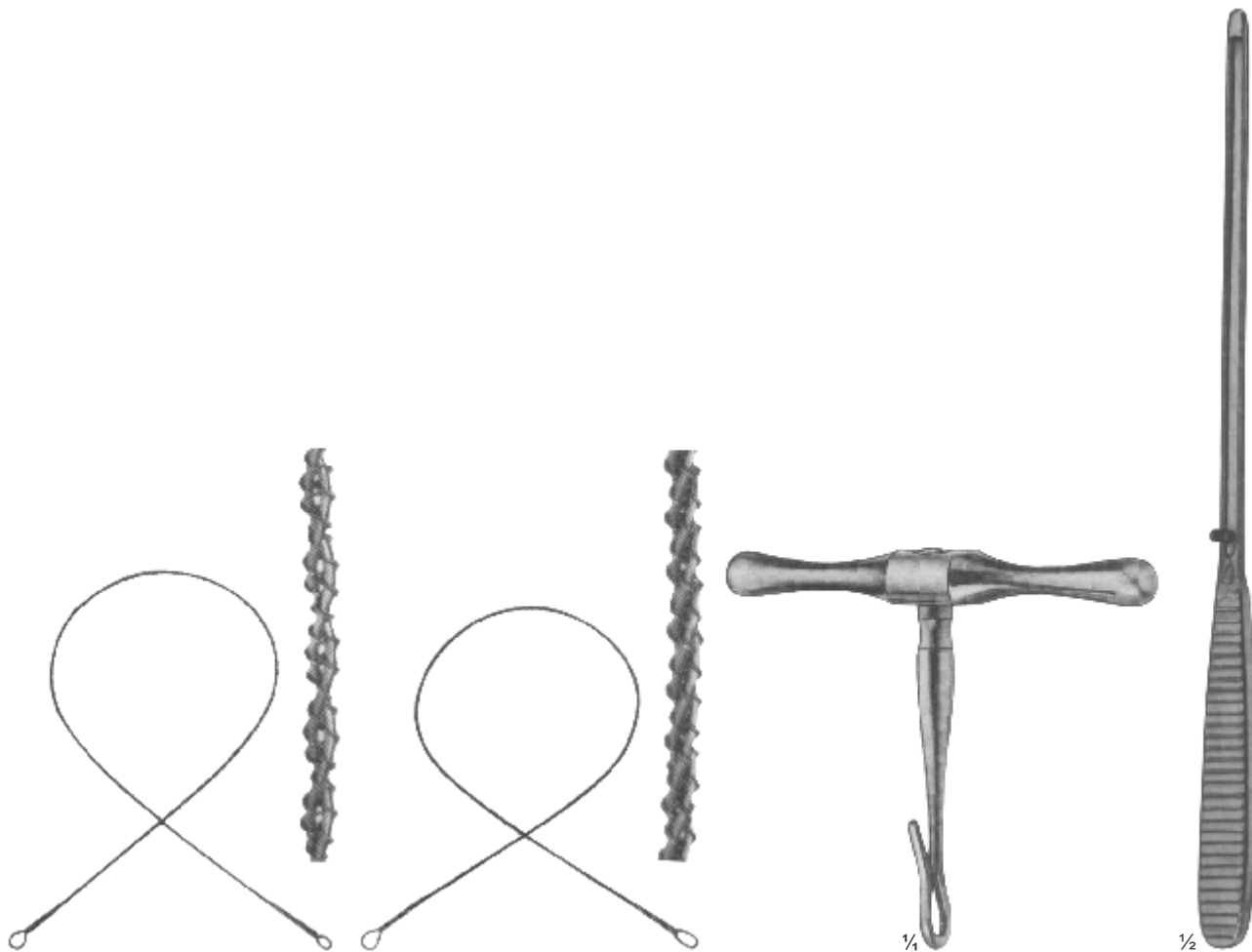

OLIVECRONA
CM19-075 300 mm
CM19-076 400 mm
CM19-077 500 mm
CM19-078 700 mm

GIGLI
CM19-079 300 mm
CM19-080 400 mm
CM19-081 500 mm
 fine, 6 wires twisted
CM19-082
 coarses, 4 wires twisted

CM19-083
 GIGLI
 Handle

CM19-084
 LEBSCHÉ
 Conductor for
 wire saws, malleable
 250 mm

SKULL TRACTION TONGS

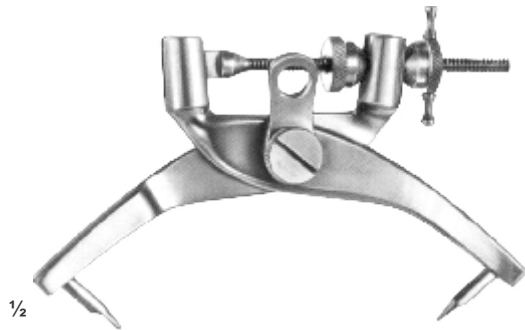

1/2

CRUTCHFIELD
CM19-085
Small Pattern



1/2

CRUTCHFIELD
CM19-086
Medium Pattern



1/2

CM19-087
Large Pattern
and Spare Pin



CM19-088
70 mm
Drill Point



CM19-089
70 mm
Drill Point

CRANIAL RONGEURS



CLIPS AND APPLYING FORCEPS

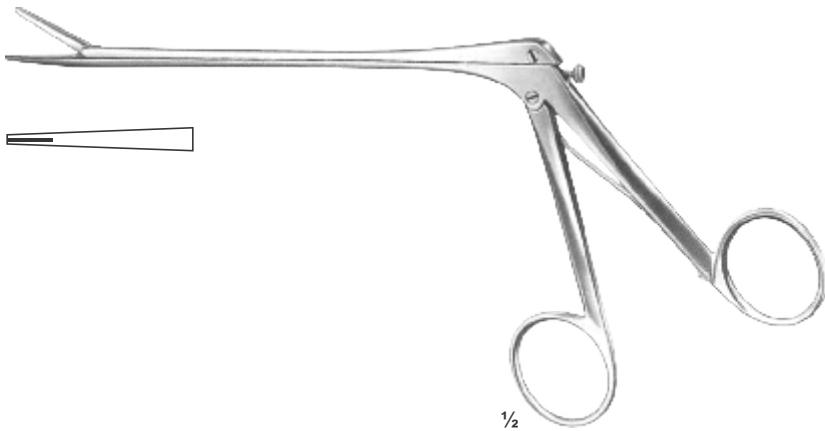

1/2

OLIVECRONA-TOENNIS
CM19-093
Clip Applying Forceps

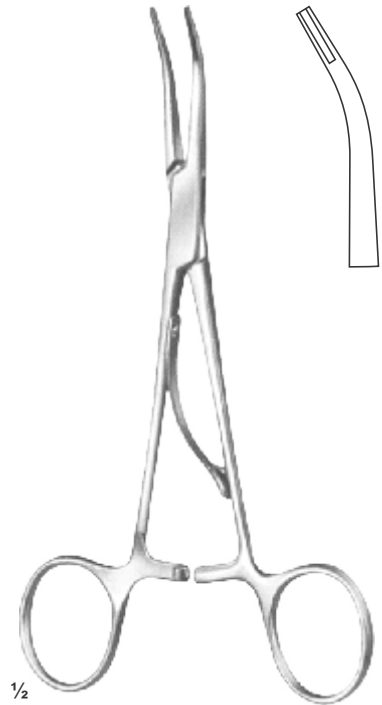

1/2

MCKENZIE
CM19-094
185 mm
Clip Applying Forceps



1/4

KÖLNER
CM19-095
Scalp Clip



1/4

RANEY
CM19-096
Scalp Clip



1/2

RANEY
CM19-097
155 mm
Applying/Removal
Forceps

BONE HAND DRILLS



STILLE
CM19-098 - 109
 complete
 20 cm



CM19-098
 2.5 mm



CM19-099
 3.0 mm



CM19-100
 3.5 mm



CM19-101
 4.0 mm



CM19-102
 10.0 mm



CM19-103
 5.0 mm



CM19-104
 8.0 mm



CM19-105
 12.0 mm



CM19-106
 16.0 mm



CM19-107
 1.0 mm



CM19-108
 1.5 mm



CM19-109
 2.0 mm



CM19-110
 2.5 mm



CM19-111
 3.0 mm



CM19-112
 3.5 mm

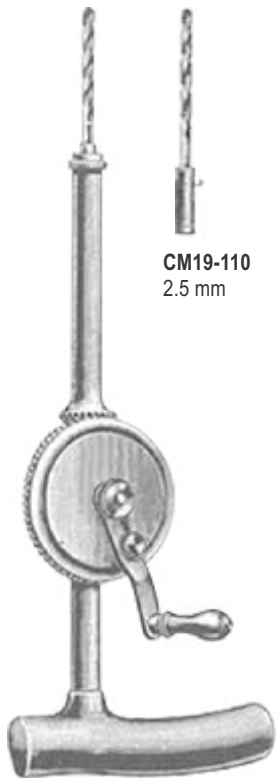

STILLE-SHERMAN
CM19-110 - 112
 complete
 24 cm



MOORE
CM19-113
 complete
 28 cm



Set of 3

BONE HAND DRILLS

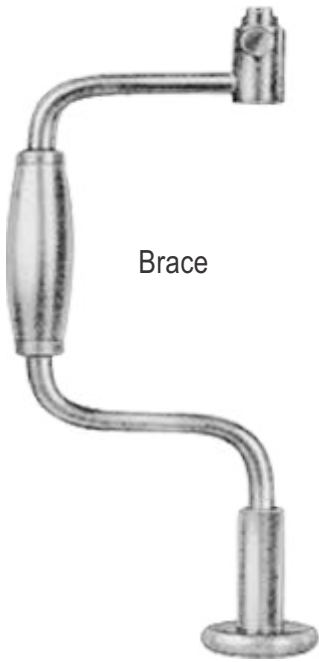

Brace

HUDSON
CM19-114 - 123
Complete Set
27 cm



CM19-114
9 mm



CM19-115
14 mm



CM19-116
16 mm



CM19-117
22 mm



CM19-118
14 mm



CM19-119
Extension
Piece



CM19-120
Mckenzie
15 mm



CM19-121
Mckenzie
2.0 mm



CM19-122
Mckenzie
1.3 mm



CM19-123
Derrico
1.6 mm



KIRSCHNER
CM19-124
Complete



Telescope Wire
Dill Guide



CM19-125
Complete



Telescope Wire
Dill Guide

BONE HAND DRILLS



BUNNELL
CM19-126



ROLK
CM19-127

BONE HAND DRILLS

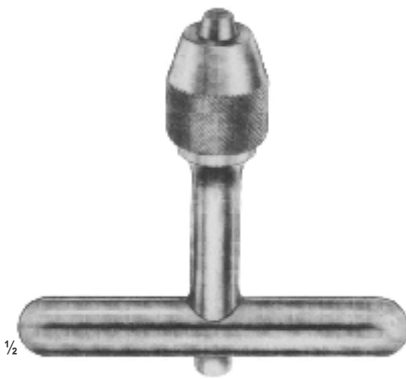

CM19-128
Drilling chuck, cannulated,
for shanks up to 6.35 mm diam.,
To be tightened by hand
10 cm

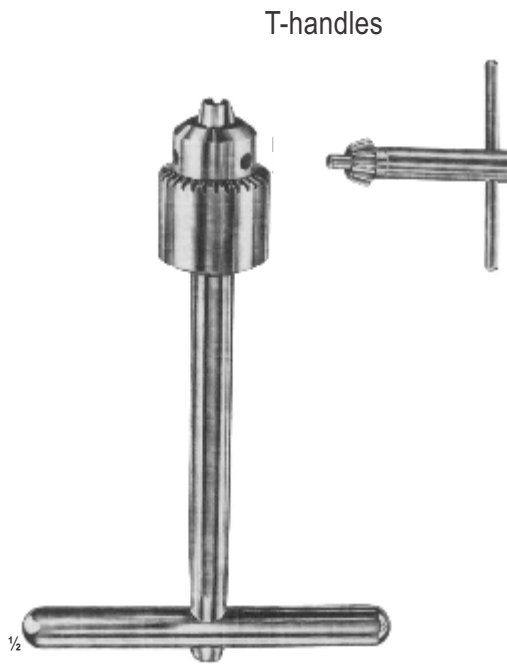

CM19-129
Drilling chuck, cannulated,
for shanks up to 6.35 mm diam.,
With key
16 cm

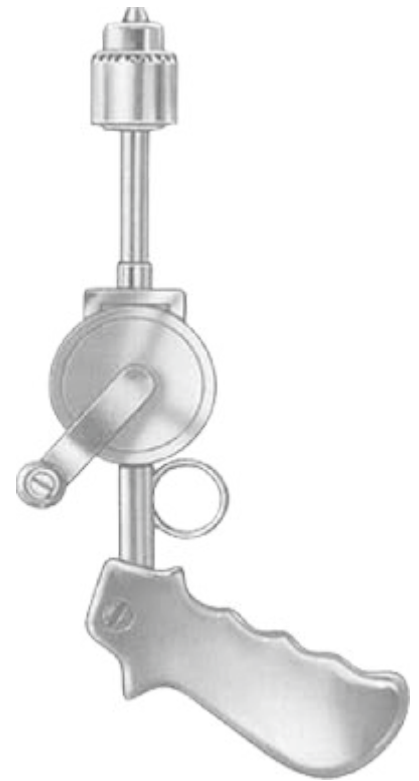

CM19-130



CARE MEDICAL[®]
SUPPLIES

Your health _ Our Priority

Section

20

Page 385-403

Elevators And Bone Levers
Raspatories With Hartpress-handle
Bone Curettes

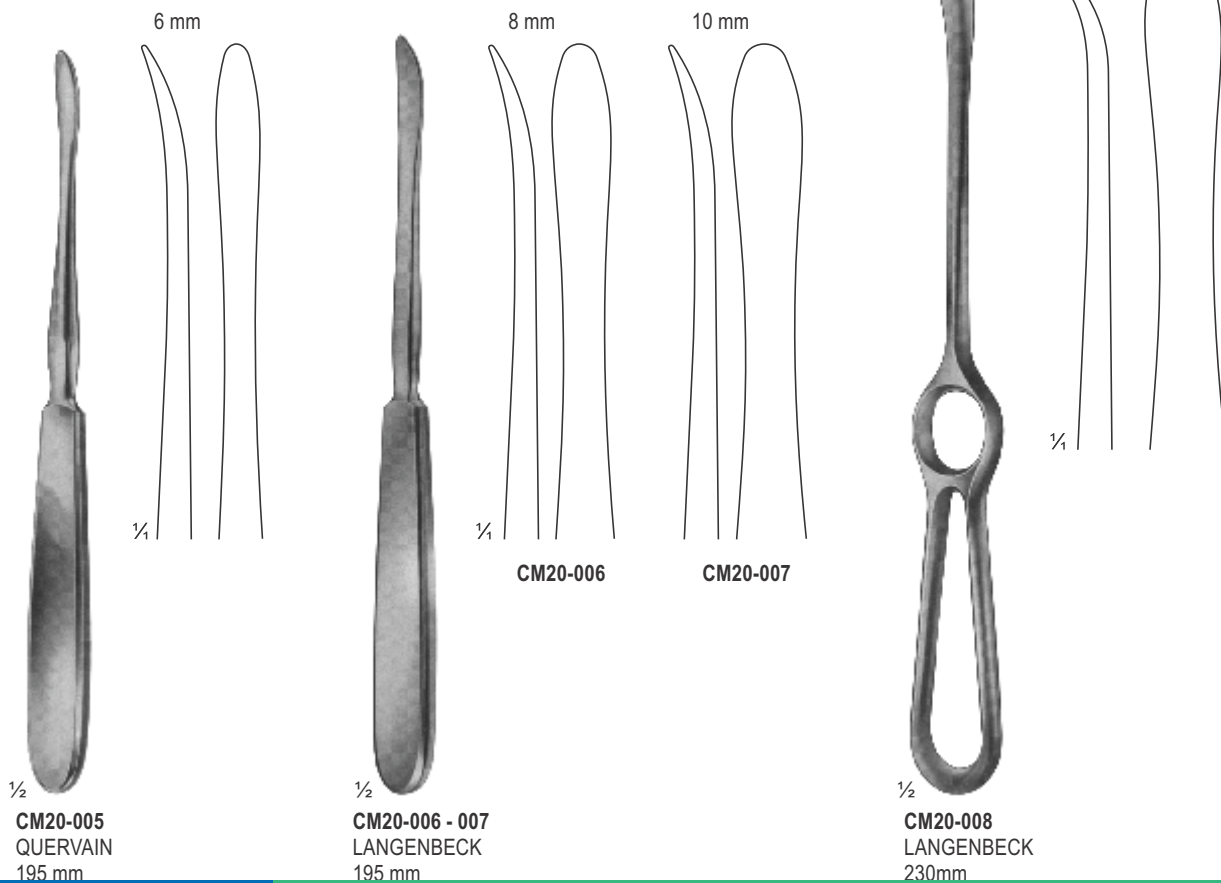
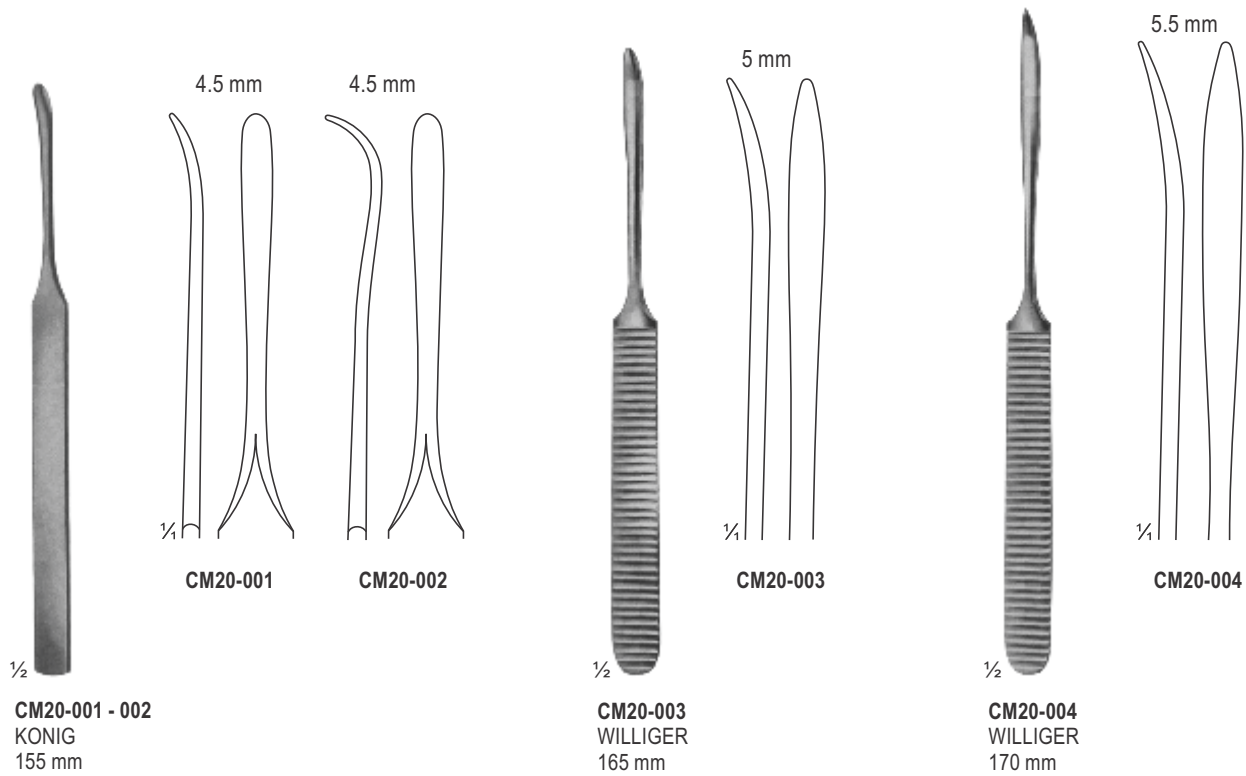

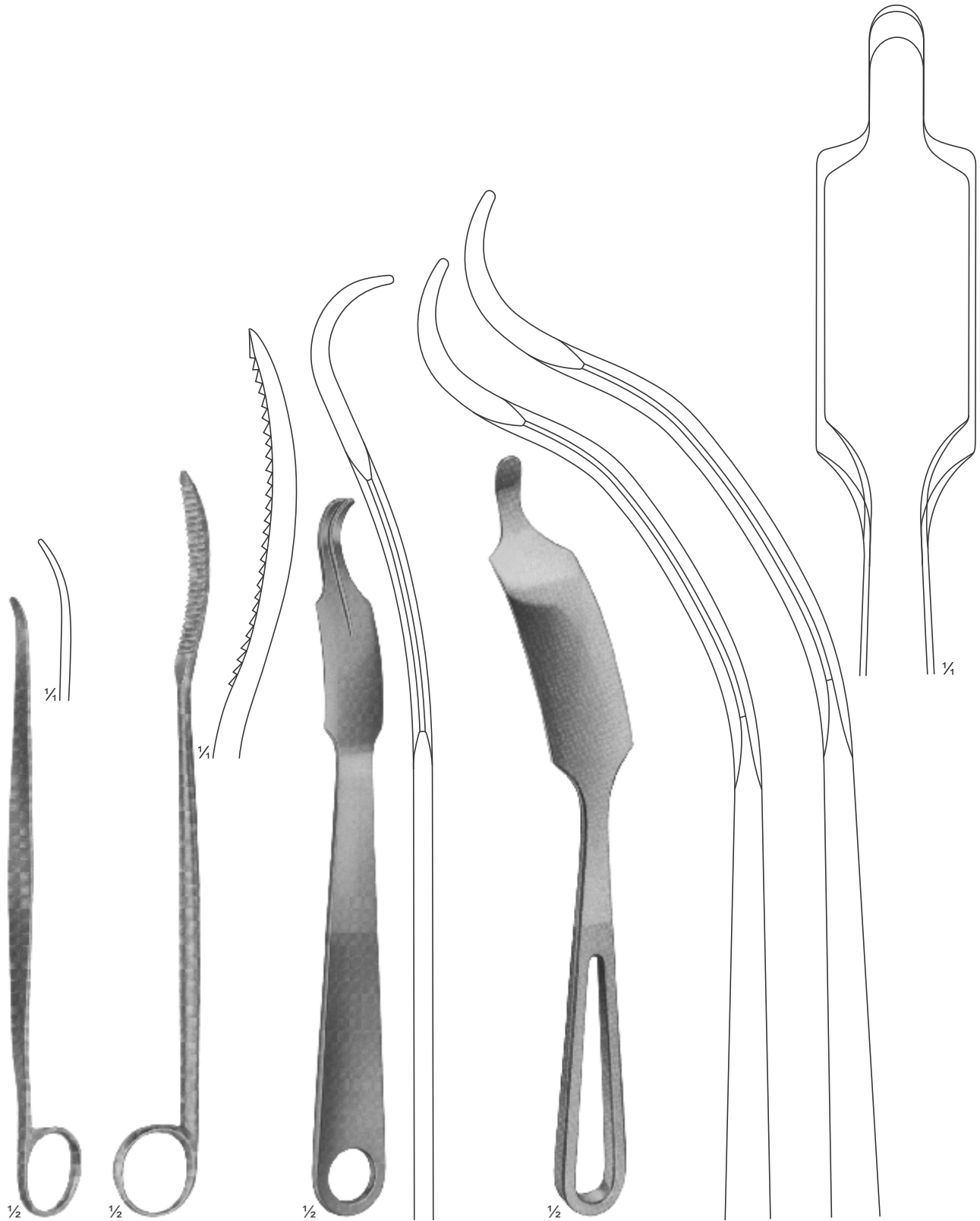

CM20-009
LANE
TRETOWAN
215mm

CM20-010
LANE
255mm

CM20-011
LANGE-HOHMANN
250mm

CM20-012 - 013
LANGE-HOHMANN
CM20-012 265mm
CM20-013 280mm

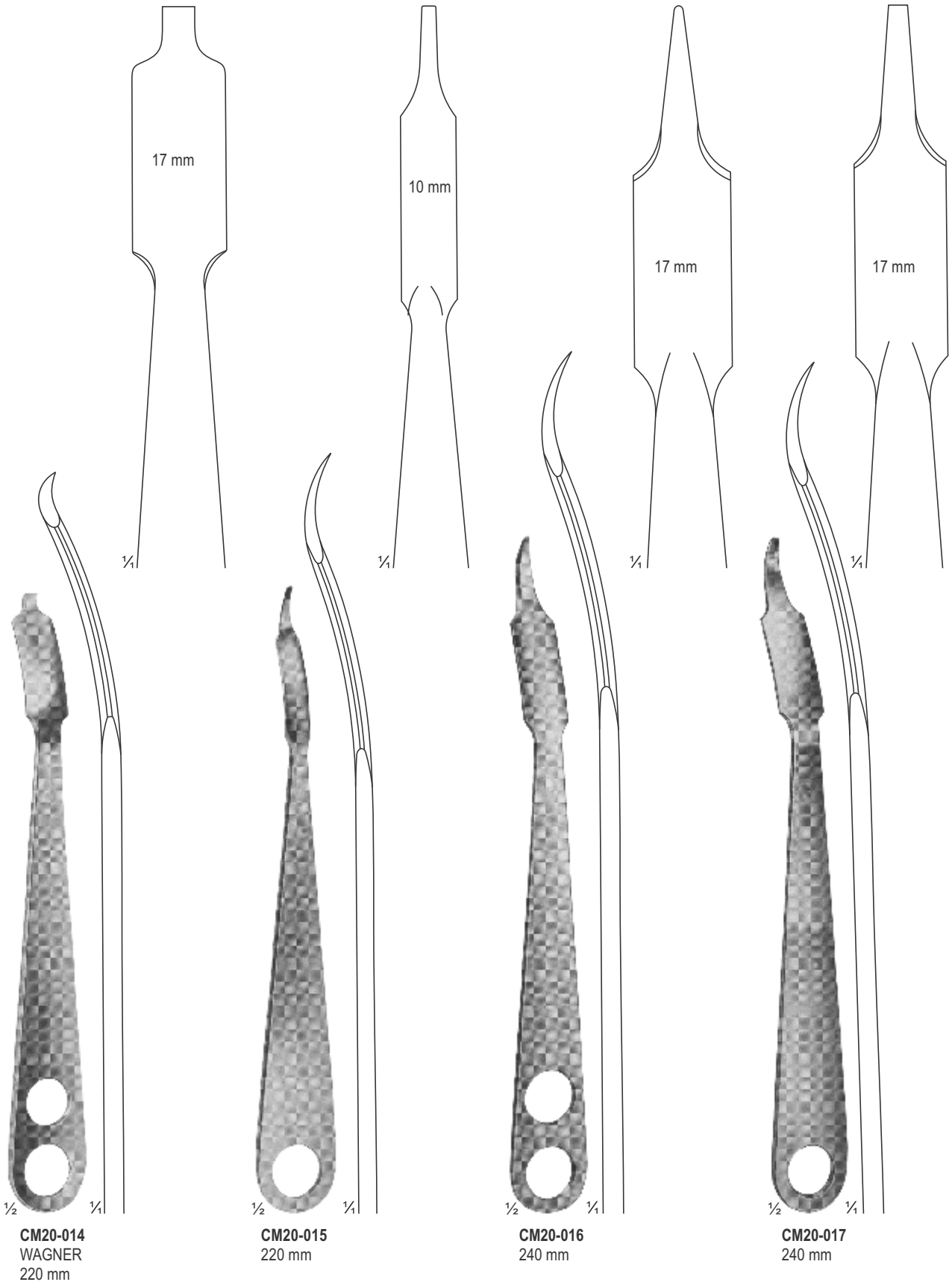

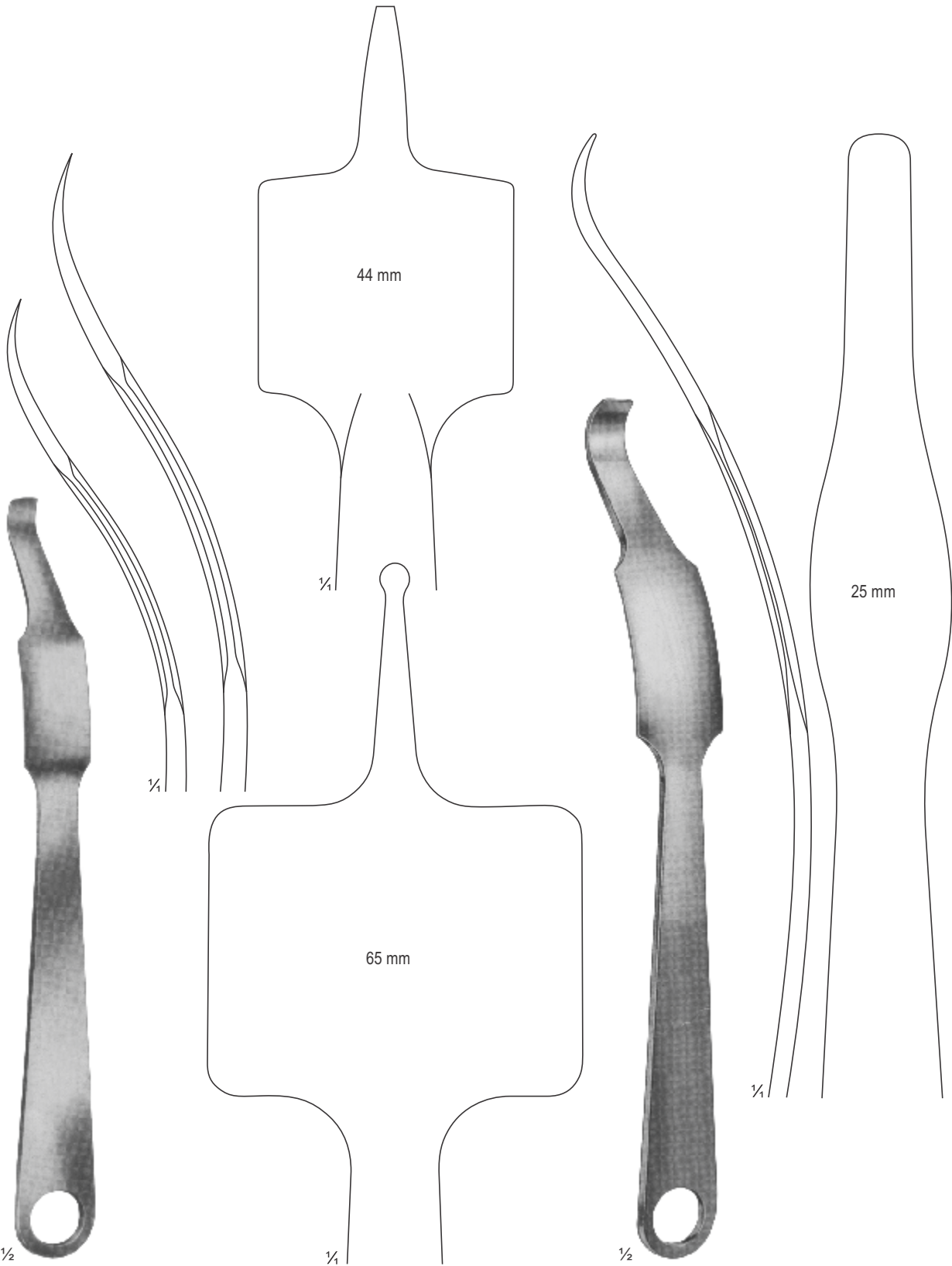

CM20-018 - 019
VERBRUGGE-MULLER
CM20-018 240 mm
CM20-019 255 mm

CM20-020
260 mm

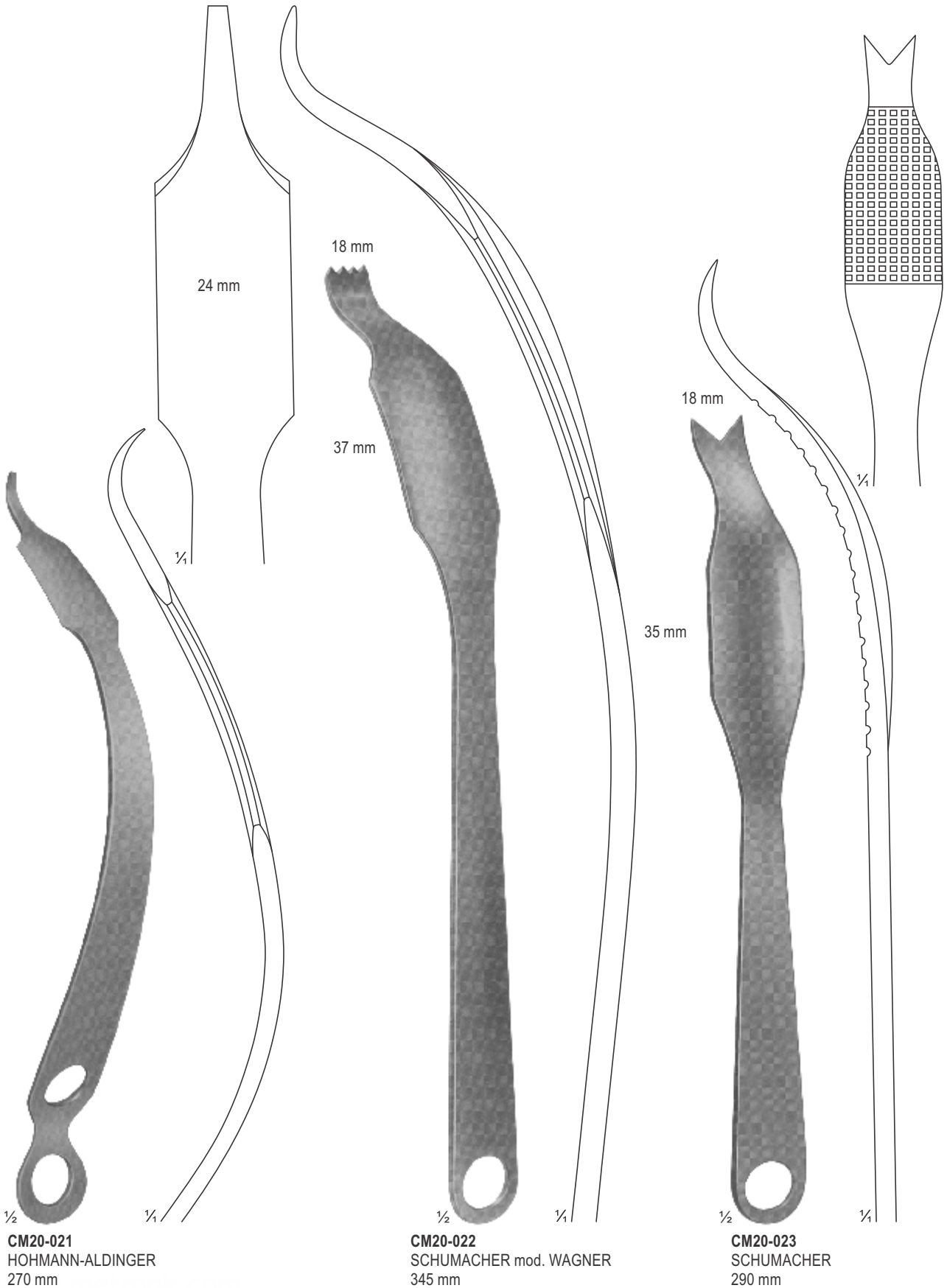

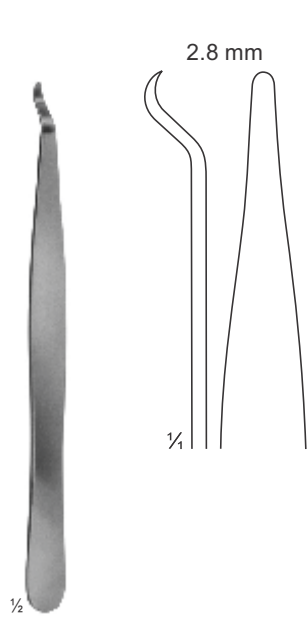

CM20-024
140 mm

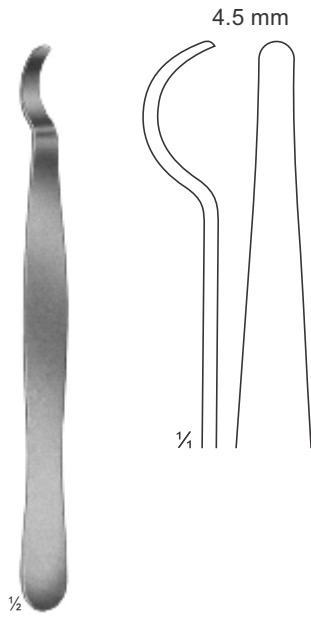

CM20-025
150 mm

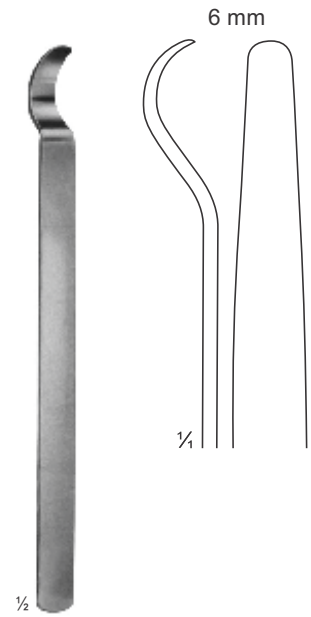

CM20-026
150 mm

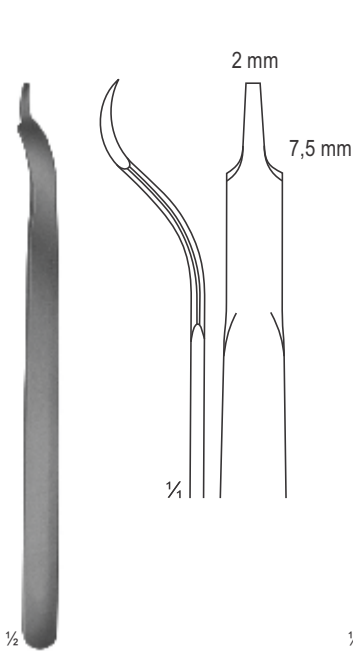

BUCK-GRAMCKO
CM20-027
150 mm

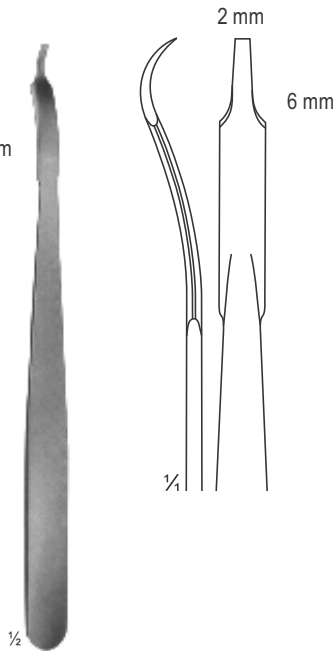

CM20-028
160 mm

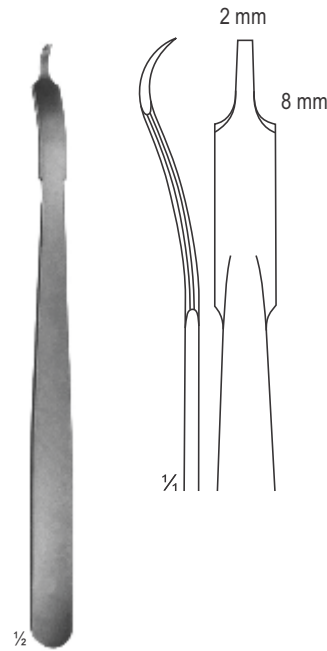

CM20-029
160 mm

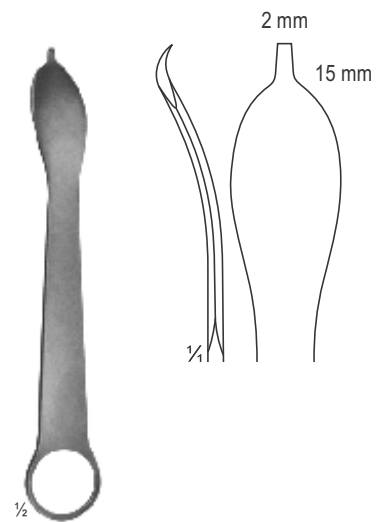

CM20-030
125 mm

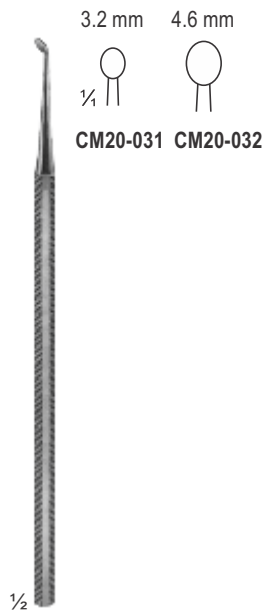

CM20-031 - 032
PARTSCH
150 mm

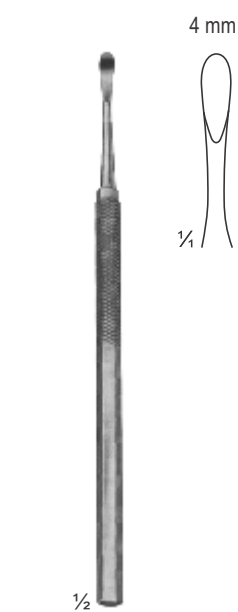

CM20-033
PARTSCH mod. LANGE
145 mm

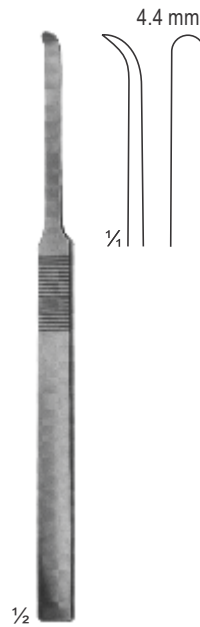

CM20-034
MC KENTY
155 mm

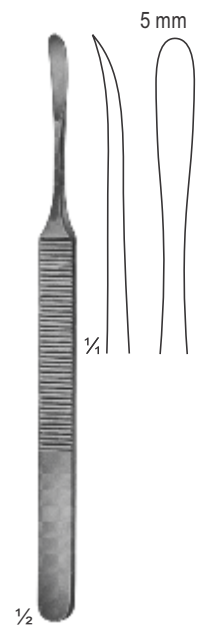

CM20-035
KONIG
155 mm

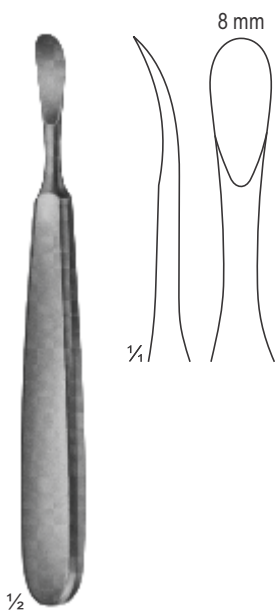

CM20-036
TRELAT
150 mm

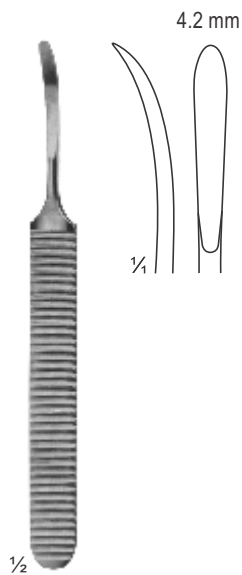

CM20-037
WILLIGER
140 mm

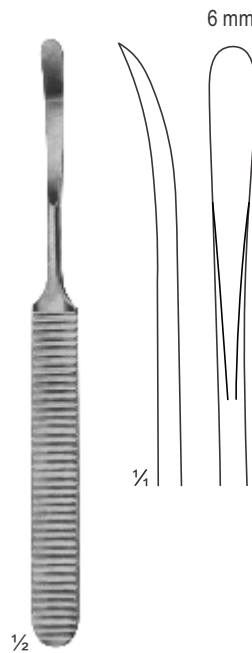

CM20-038
WILLIGER
160 mm

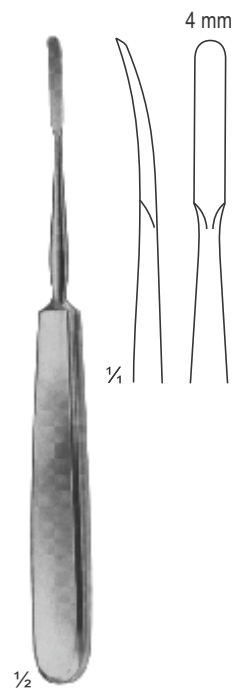

CM20-039
JOSEPH
170 mm

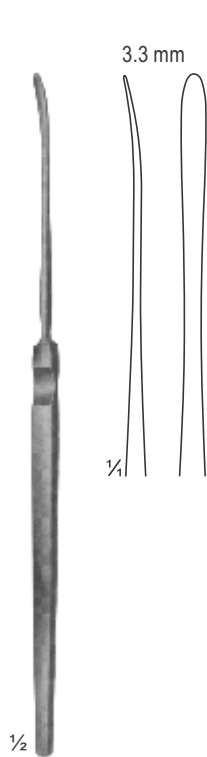

CM20-040
HALLÉ
stumpf/blunt
180 mm

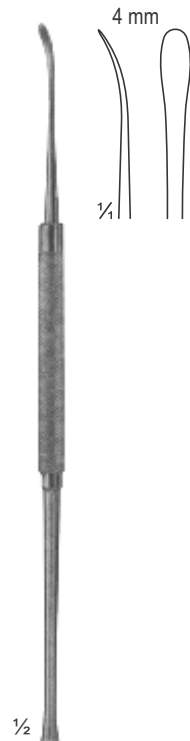

CM20-041
FREER
stumpf/blunt
190 mm

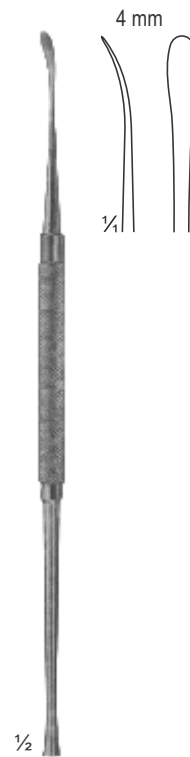

CM20-042
FREER
stumpf/sharp
190 mm



CM20-043
SEWALL
stumpf/blunt
190 mm

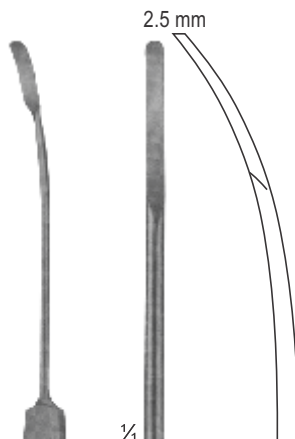

CM20-044

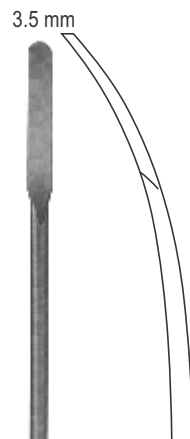

CM20-045

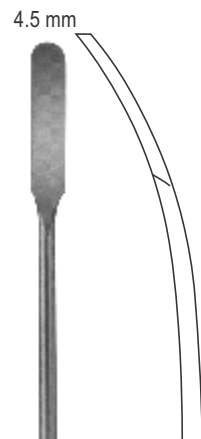

CM20-046

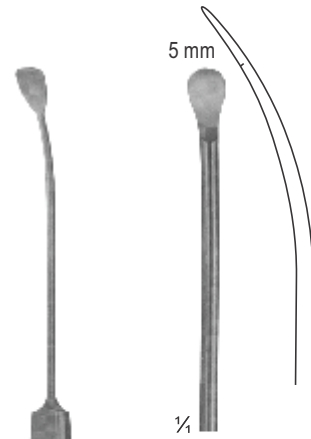

CM20-047

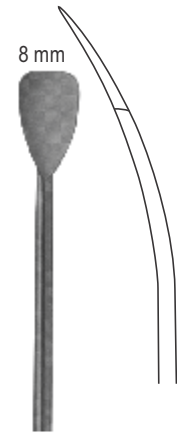

CM20-048

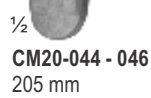

CM20-044 - 046
205 mm

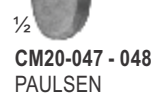

CM20-047 - 048
PAULSEN

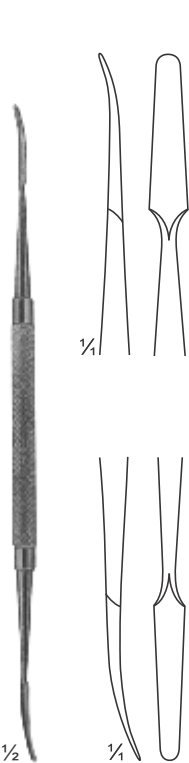

CM20-049
KILLIAN
sharp/blunt
185 mm

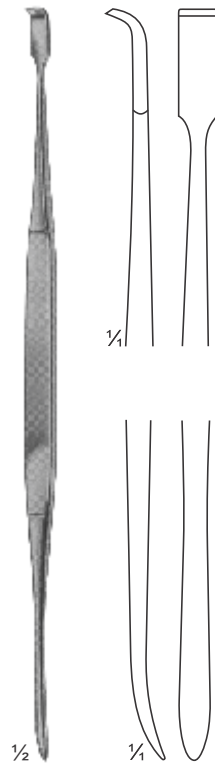

CM20-050
HOWARTH
sharp/blunt
215 mm

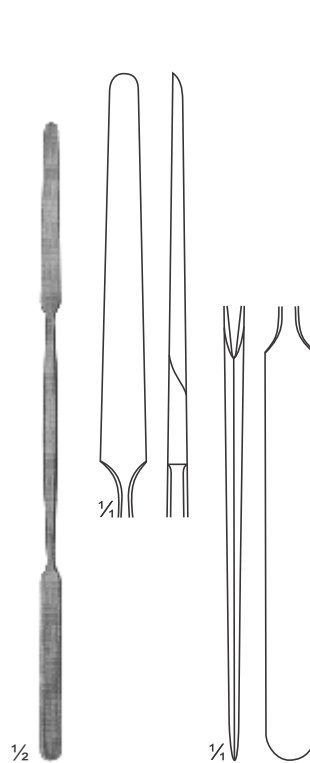

CM20-051
KILLIAN
sharp/blunt
185 mm

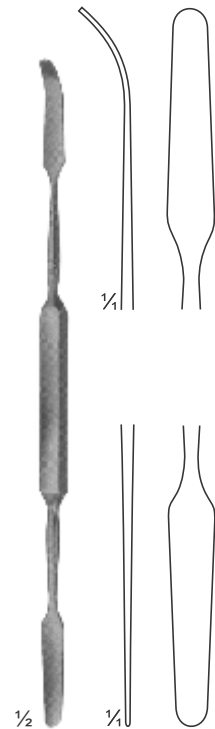

CM20-052
MAC DONALD
blunt/blunt
185 mm

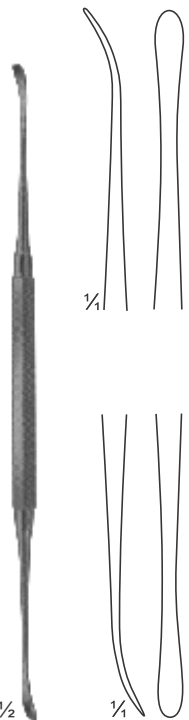

CM20-053
FREER
sharp/blunt
185 mm

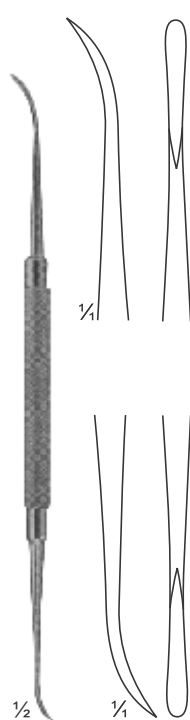

CM20-054
FREER-YASARGIL
sharp/sharp
185 mm

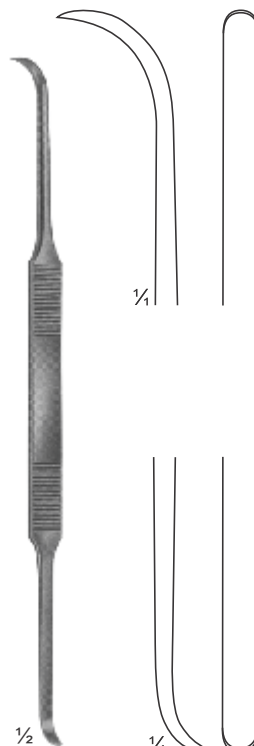

CM20-055
COTTLE
sharp/sharp
200 mm

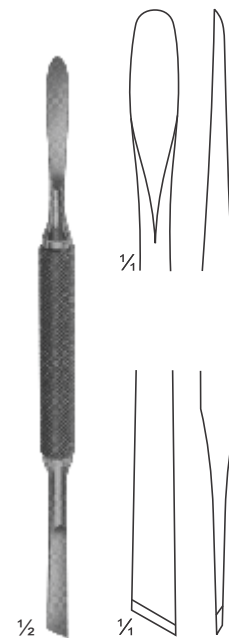

CM20-056
MEAD
sharp/sharp
165 mm

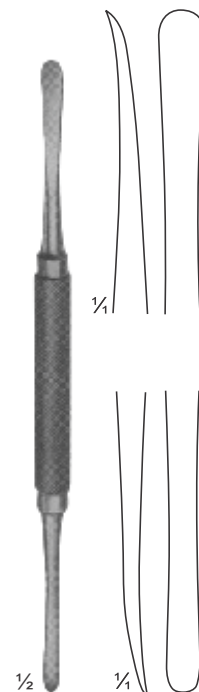

CM20-057
MOLT
sharp/sharp
180 mm

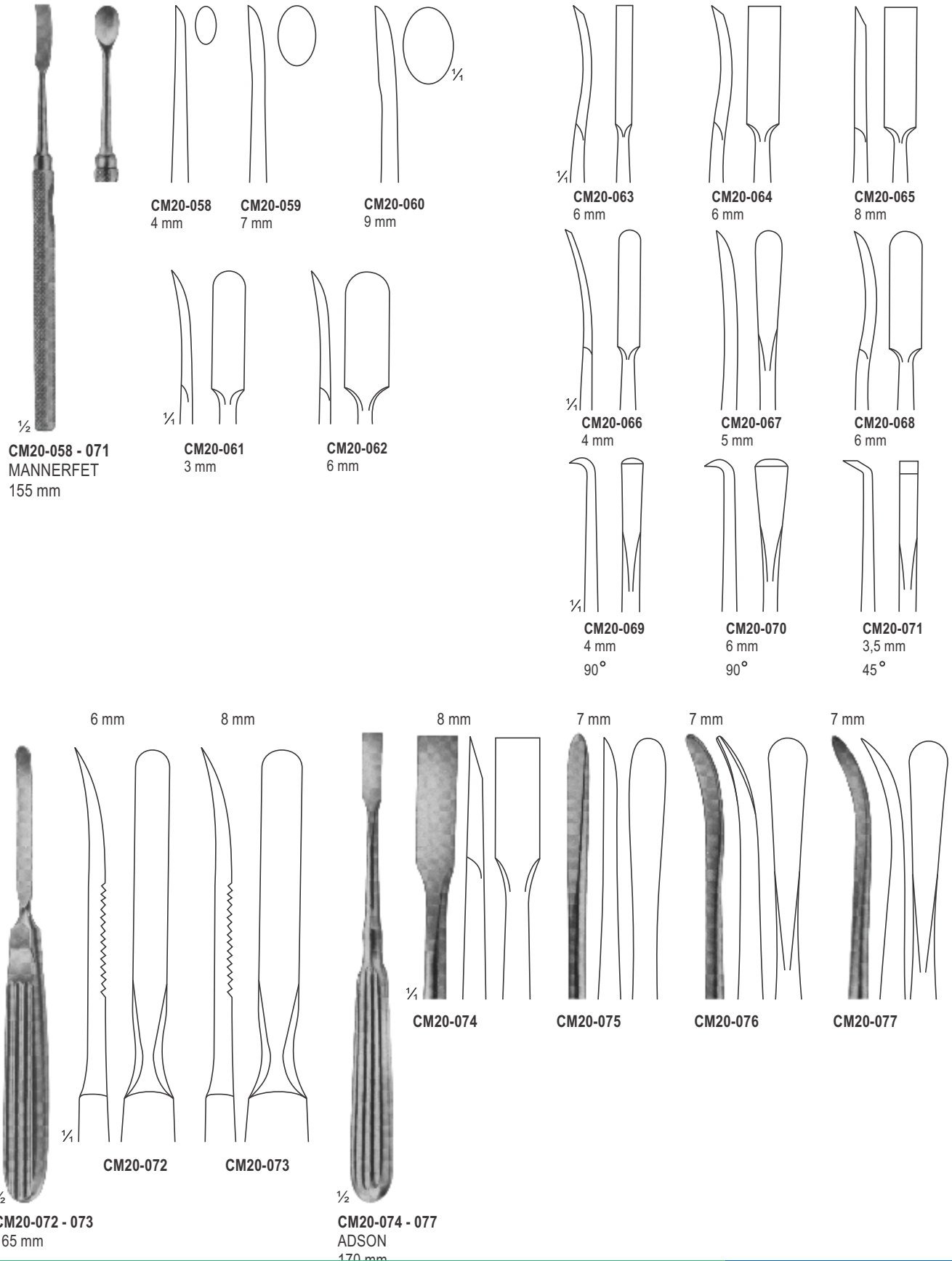

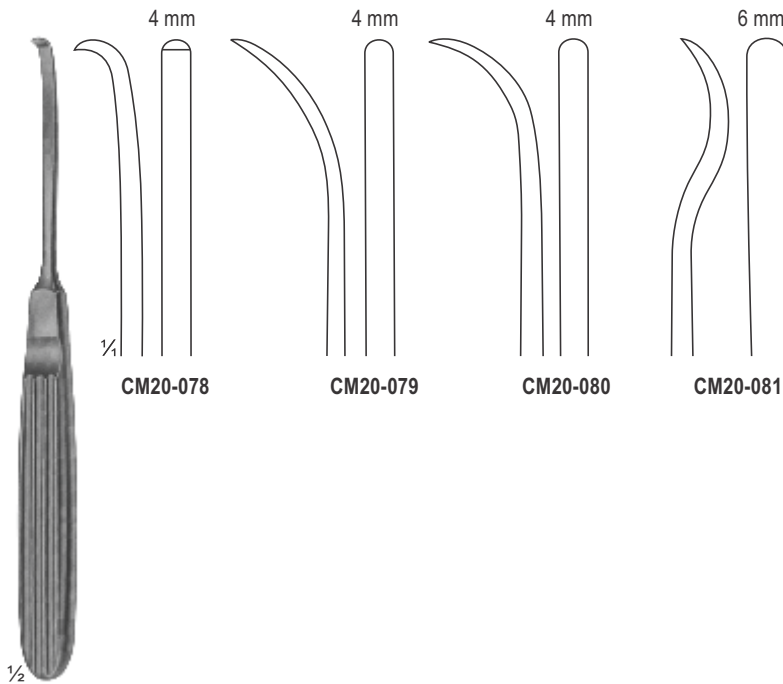

CM20-078 - 081
MUHLING
170 mm

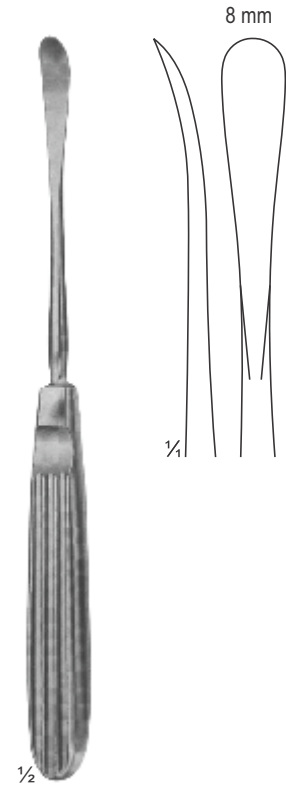

CM20-082
COTTLE
175 mm

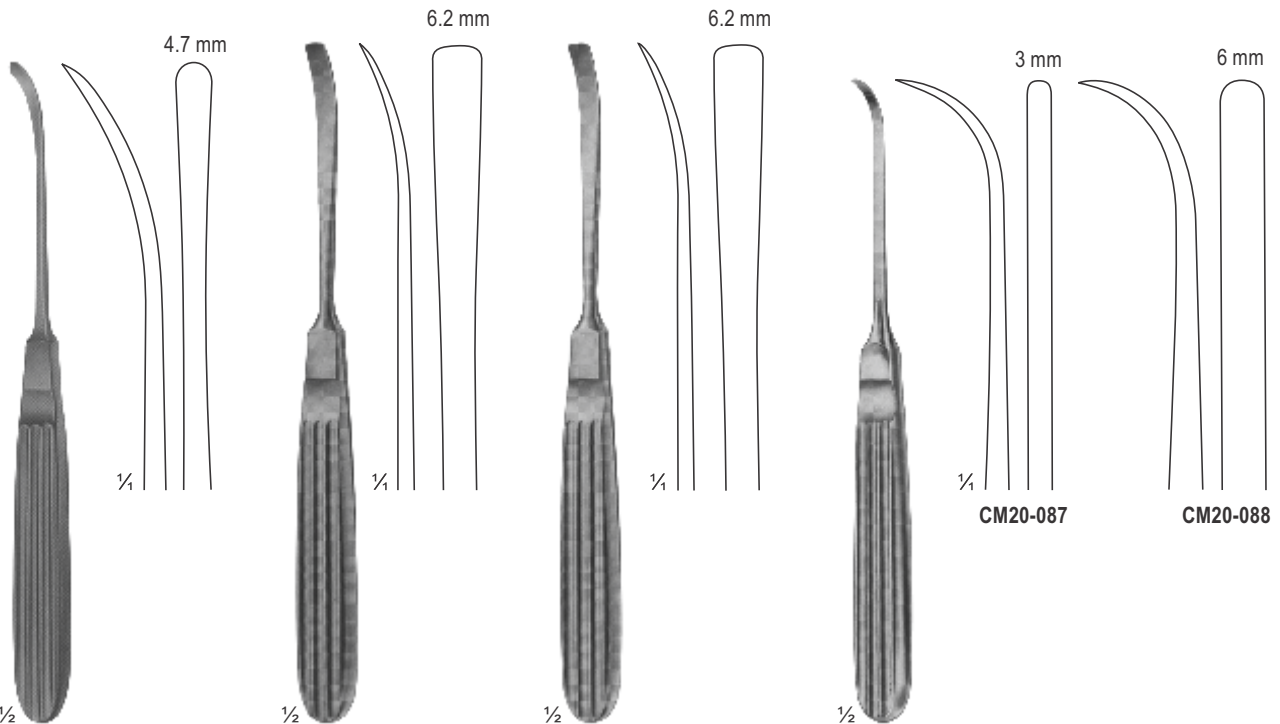

CM20-083
LANDOT
175 mm

CM20-084
CASPER
180 mm

CM20-085
CASPER
180 mm

CM20-086 - 088
170 mm

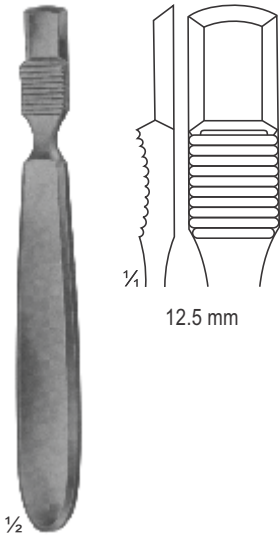

12.5 mm

1/2

CM20-089
FARABEU
140 mm

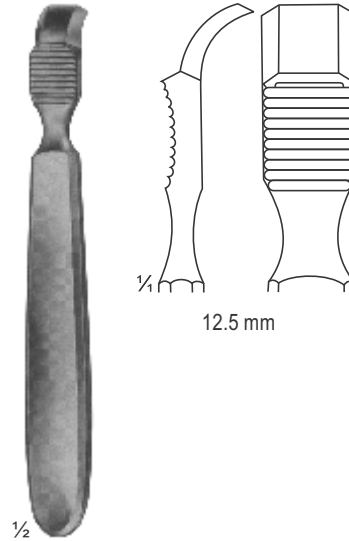

12.5 mm

1/2

CM20-090
FARABEU
140 mm

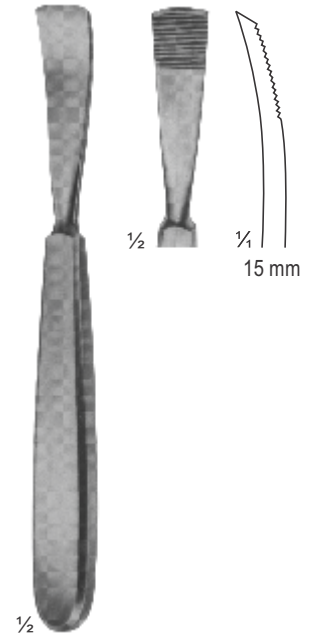

1/2

1/4

15 mm

1/2

CM20-091
JANSEN
165 mm

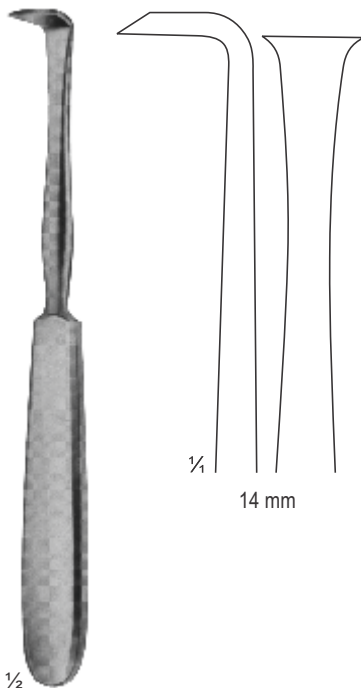

1/4

14 mm

1/2

CM20-092
LANGENBECK
180 mm

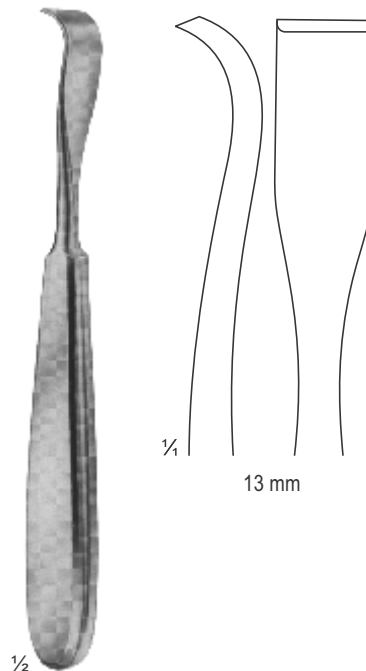

1/4

13 mm

1/2

CM20-093
SCHNEIDER
175 mm

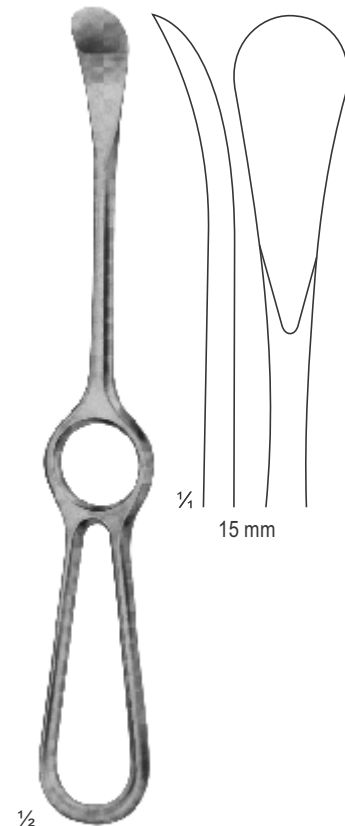

1/4

15 mm

1/2

CM20-094
SEDILOT
215 mm

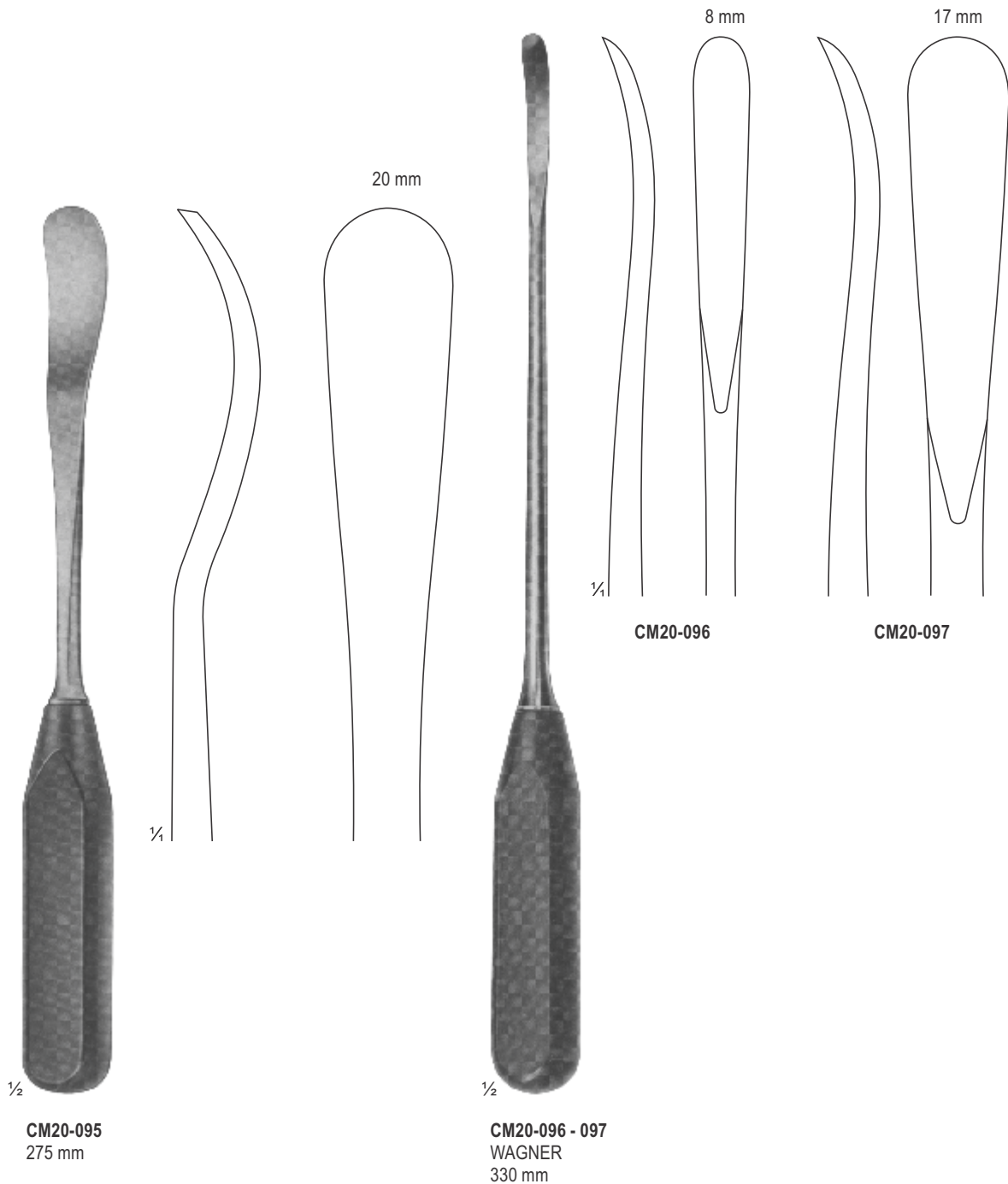

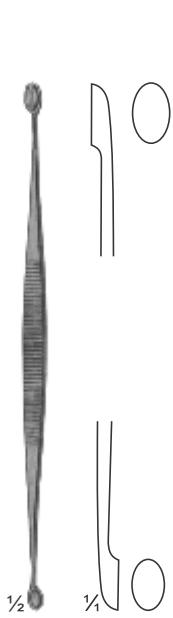

CM20-098
JACOBSON
140 mm

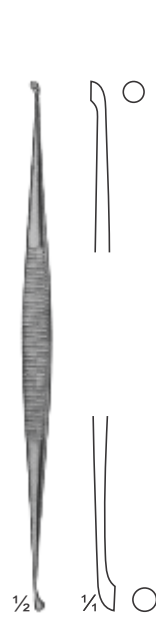

CM20-099
MARTINI
140 mm

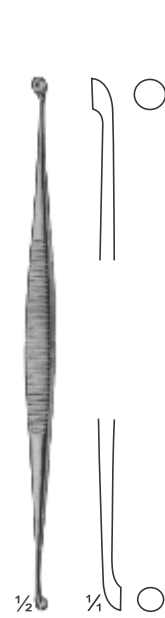

CM20-100
MARTINI
140 mm



CM20-101
WILLIGER
145 mm



CM20-102
JANSEN
160 mm



CM20-103
BARTH
180 mm

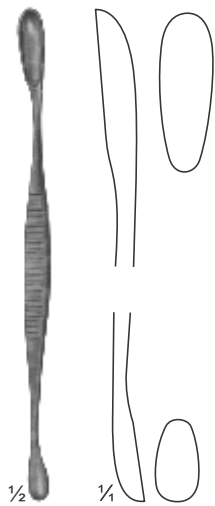

CM20-104
VOLKMANN
130 mm

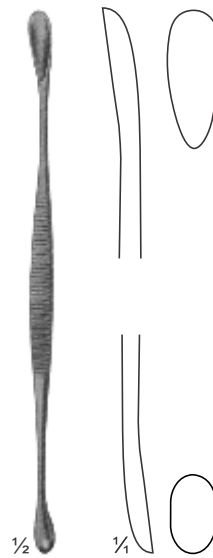

CM20-105
VOLKMANN
145 mm

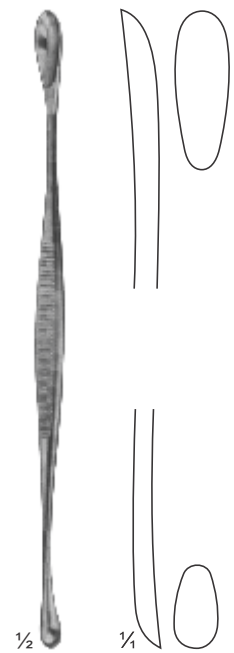

CM20-106
VOLKMANN
170 mm



CM20-107
JANSEN
160 mm

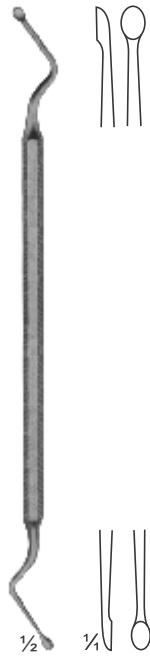

CM20-108
HEMINGWAY
170 mm

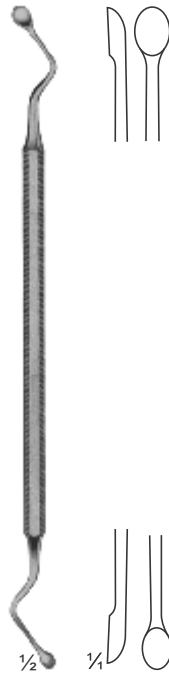

CM20-109
HEMINGWAY
175 mm

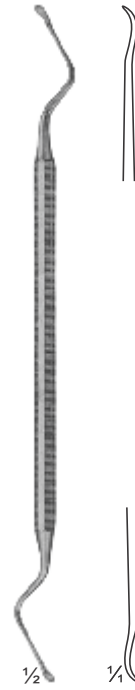

CM20-110
LUCAS
180 mm

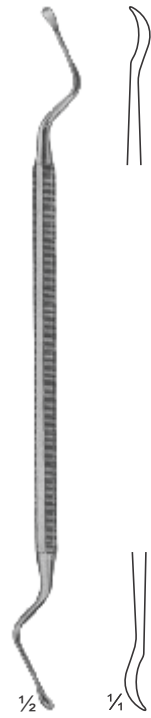

CM20-111
LUCAS
185 mm

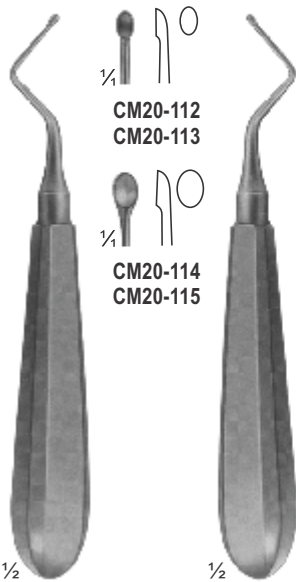

CM20-112 - 113
KERPEL
145 mm

CM20-114 - 115
KERPEL
145 mm

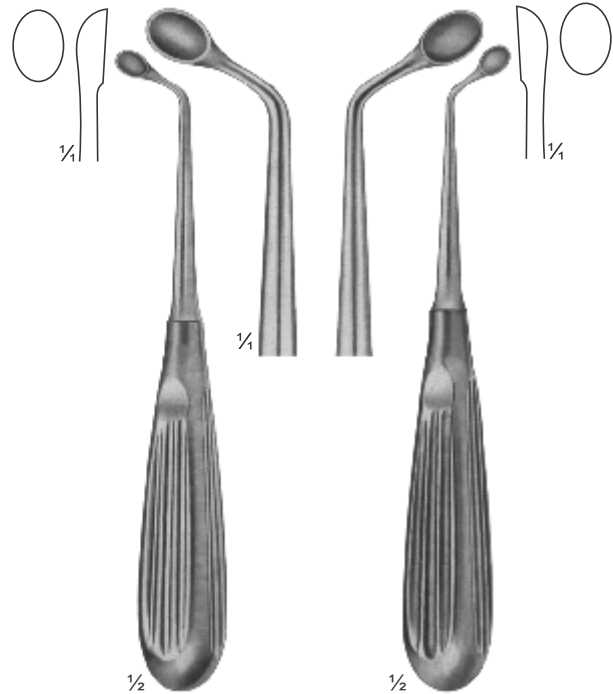

CM20-116
UFFENORDE
170 mm

CM20-117
UFFENORDE
170 mm



CM20-118 - 124
BRUNS
165 mm



CM20-118
3 mm
Fig: 000



CM20-119
4 mm
00



CM20-120
5 mm
0



CM20-121
6 mm
Fig: 1



CM20-122
8 mm
2



CM20-123
10 mm
3



CM20-124
12 mm
4



CM20-125 - 131
SCHEDE
170 mm



CM20-125
2.5 mm
Fig: 000



CM20-126
3.4 mm
00



CM20-127
4.2 mm
0



CM20-128
5.2 mm
Fig: 1



CM20-129
6.3 mm
2



CM20-130
7.4 mm
3



CM20-131
8 mm
4



CM20-132 - 141
VOLKMANN
170 mm



CM20-132
2.8 mm
Fig: 0000



CM20-133
3.6 mm
000



CM20-134
4.4 mm
00



CM20-135
5.2 mm
0



CM20-136
6.8 mm
1



CM20-137
8.5 mm
Fig: 2



CM20-138
10 mm
3

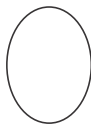

CM20-139
11.5 mm
4



CM20-140
13 mm
5



CM20-141
14.5 mm
6



CM20-142 - 143
WILLIGER
170 mm



CM20-142
3.4 mm
Fig: 00



CM20-143
5.2 mm
1



1/2

CM20-144 - 148
LEMPERT
215 mm

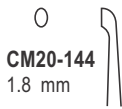

CM20-144
1.8 mm



CM20-145
2 mm



CM20-146
2.4 mm



CM20-147
2.6 mm



CM20-148
2,8 mm



1/2

CM20-149 - 151
HALLE
215 mm

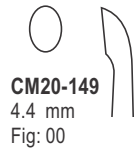

CM20-149
4.4 mm
Fig: 00

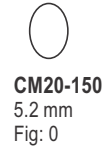

CM20-150
5.2 mm
Fig: 0

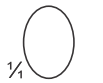

CM20-151
6.8 mm
Fig: 1



1/2

CM20-152 - 155
DAUBENSPECK
200 mm

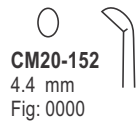

CM20-152
4.4 mm
Fig: 0000

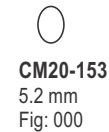

CM20-153
5.2 mm
Fig: 000

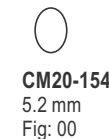

CM20-154
5.2 mm
Fig: 00

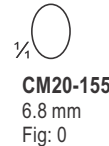

CM20-155
6.8 mm
Fig: 0



CM20-156
 3.6 mm
 Fig: 000

CM20-157
 4.4 mm
 Fig: 00



CM20-158
 5.2 mm
 Fig: 0

CM20-159
 6.8 mm
 Fig: 1

$\frac{1}{2}$
CM20-156 - 159
 250 mm



CM20-160
 3.6 mm
 Fig: 000

CM20-161
 4.4 mm
 Fig: 00

CM20-162
 5.2 mm
 Fig: 0

CM20-163
 6.8 mm
 Fig: 1

$\frac{1}{2}$
CM20-160 - 163
 250 mm



CM20-164
 3 mm

CM20-165
 4 mm

CM20-166
 5 mm

$\frac{1}{2}$
CM20-164 - 166
 BUSHE
 250 mm

$\frac{1}{4}$ O
Fig. 1
CM20-167

$\frac{1}{4}$ O
Fig. 1
CM20-173

$\frac{1}{4}$ O
Fig. 1
CM20-179

O
Fig. 2
CM20-168

O
Fig. 2
CM20-174

O
Fig. 2
CM20-180

O
Fig. 3
CM20-169

O
Fig. 3
CM20-175

O
Fig. 3
CM20-181

O
Fig. 4
CM20-170

O
Fig. 4
CM20-176

O
Fig. 4
CM20-182



O
Fig. 5
CM20-171

O
Fig. 5
CM20-177

O
Fig. 5
CM20-183

O
Fig. 6
CM20-172

O
Fig. 6
CM20-178

O
Fig. 6
CM20-184



MODELL USA
Oval, With Hollow Handle
CM20-167 - 172
165 mm

MODELL USA
Oval, With Hollow Handle
CM20-173 - 178
165 mm

MODELL USA
Oval, With Hollow Handle
CM20-179 - 184
16 mm



CARE MEDICAL[®]
SUPPLIES

Your health _ Our Priority

Section

21

Page 404-460

Tendon Holding Forceps, Tendon Tunneling Forceps
Cartilage Seizing, Repositioning, Bone Holding Forceps
Osteotomes, chisels And Gouges With Handle
Wire Holding Forceps, Flat-nosed Pliers
Wire Cutting Pliers, Lateral Cutting Action
Bone Cutting Forceps
Tendon Strippers
Mallets

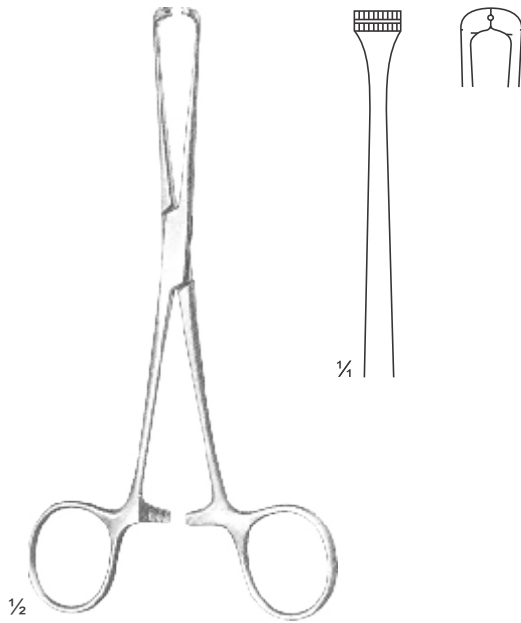

STEINMANN
CM21-001
160 mm

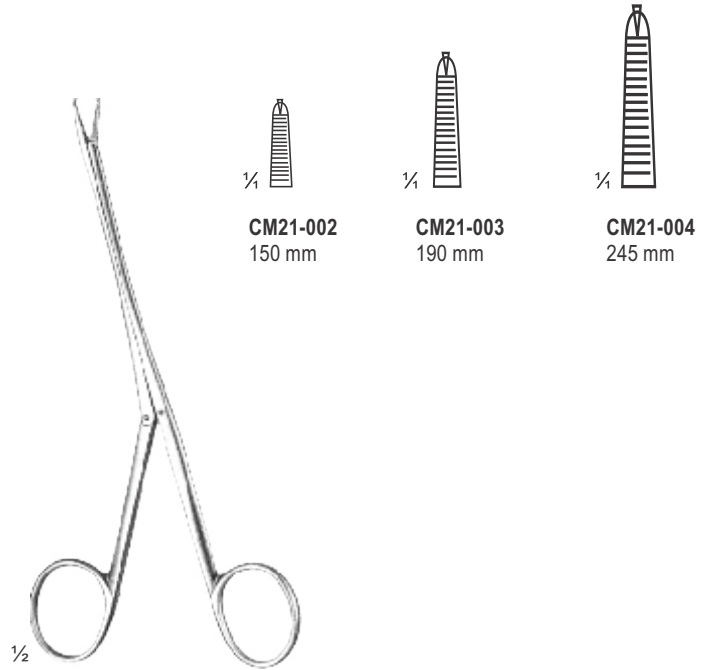

BRAND
CM21-002 - CM21-004

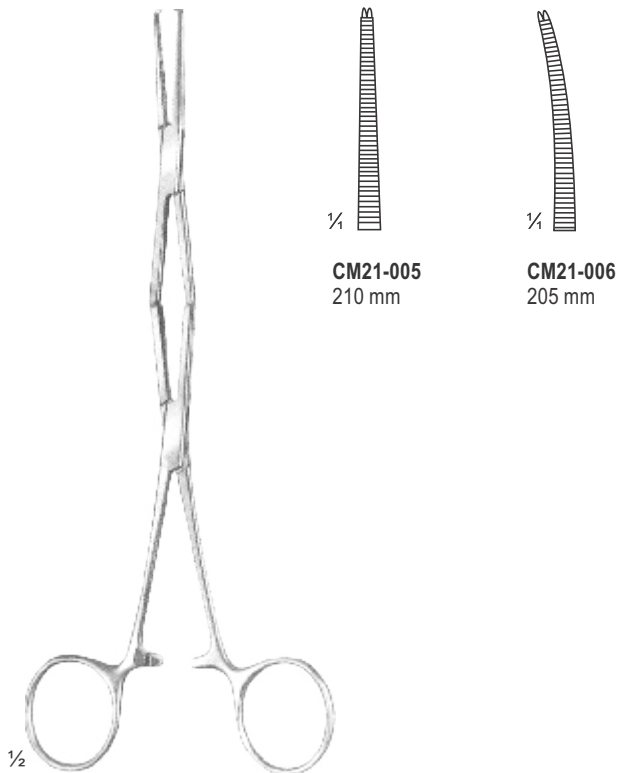

CM21-005 - CM21-006

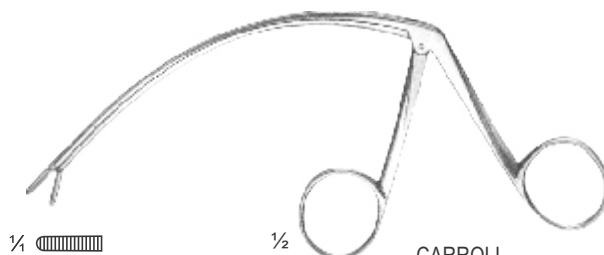

CARROLL
CM21-007
115 mm

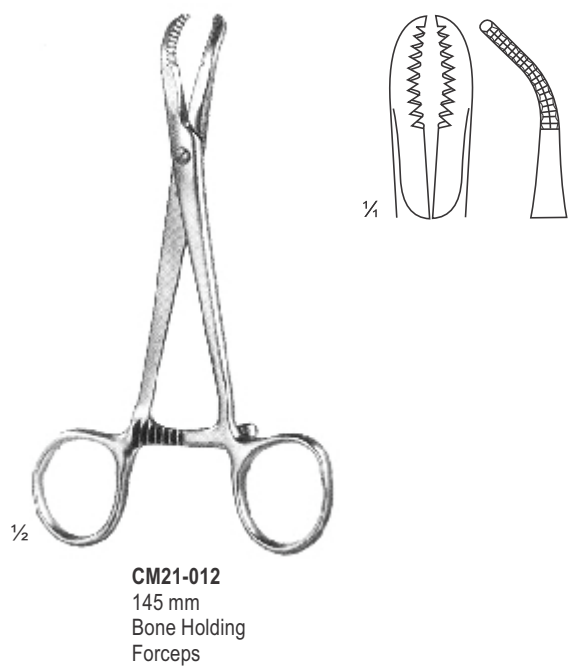
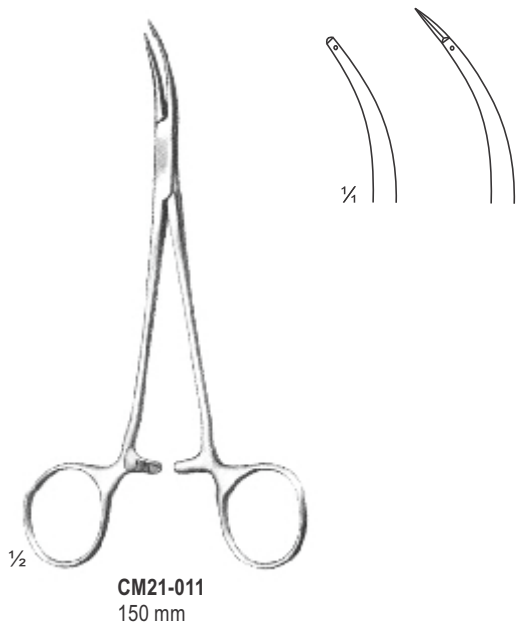
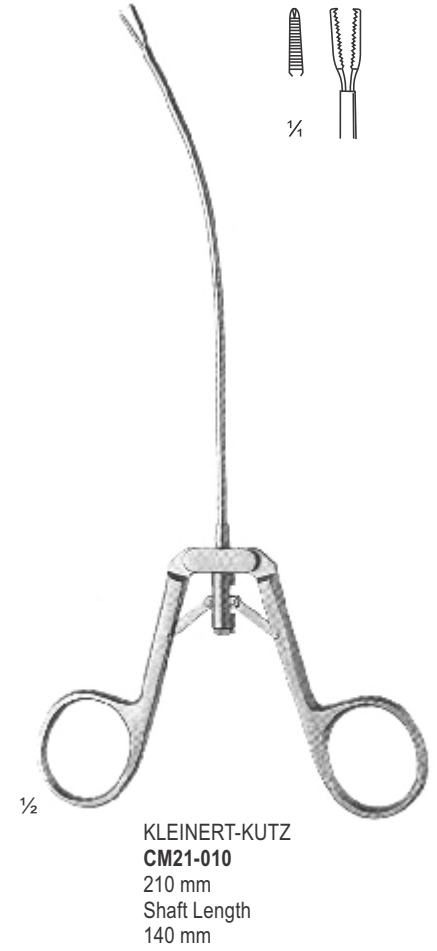
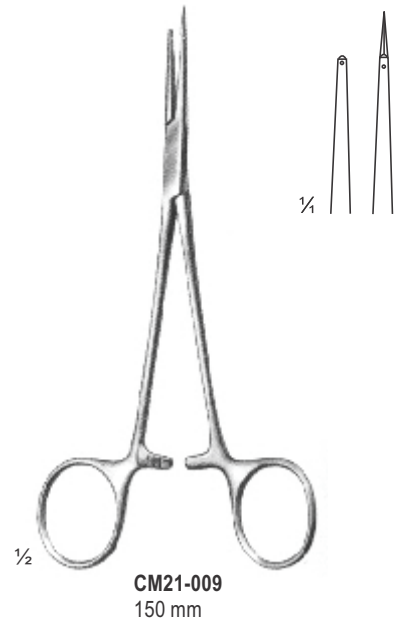
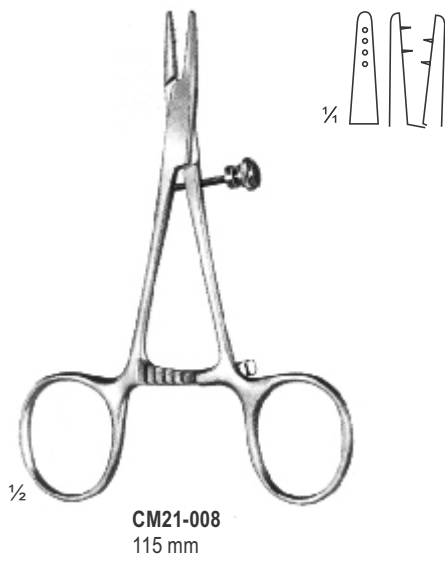

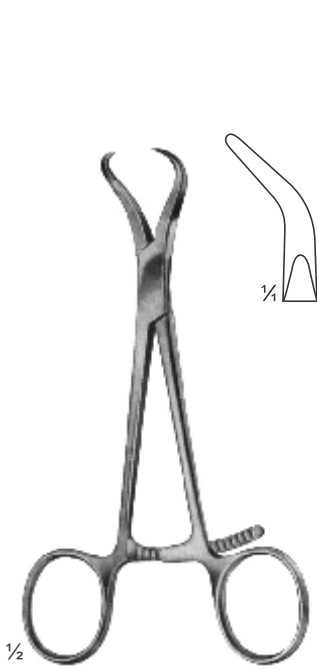

Repositioning forceps,
for small fragments
CM21-013
135 mm

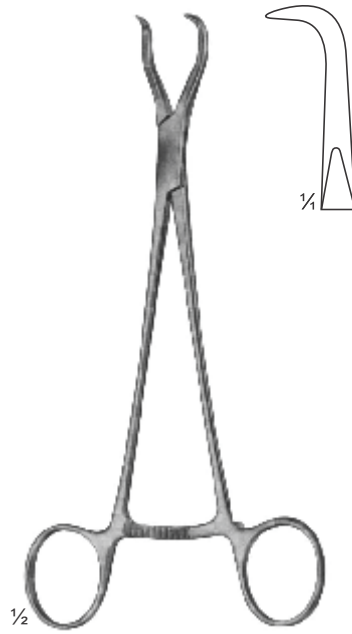

HAASE
Repositioning forceps,
for mandibular
fractures
CM21-014
165 mm

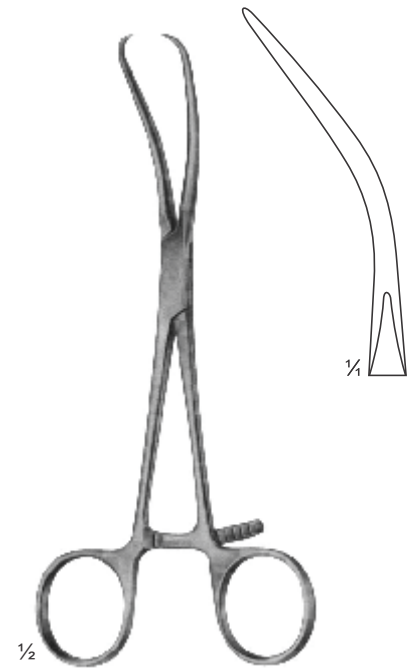

REILL
Repositioning forceps,
CM21-015
170 mm

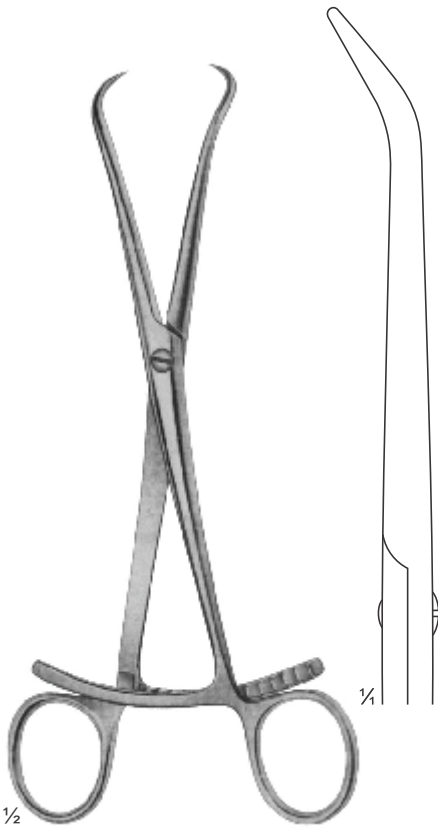

Repositioning forceps
CM21-016
205 mm

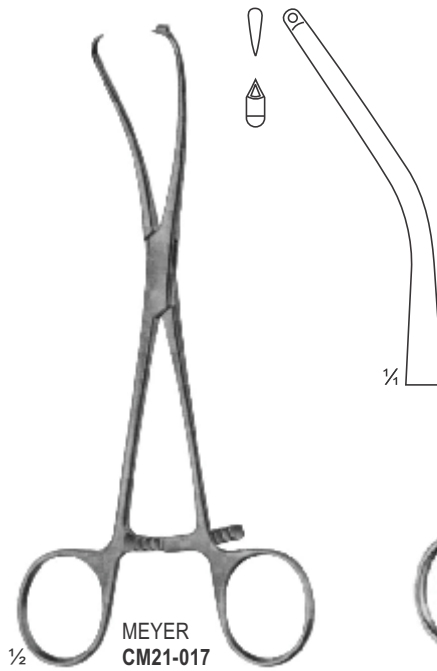

MEYER
CM21-017
Repositioning forceps
for fingers, with drill
guide for KIRSCHNER
wires up to diam. 1.0 mm
17 cm

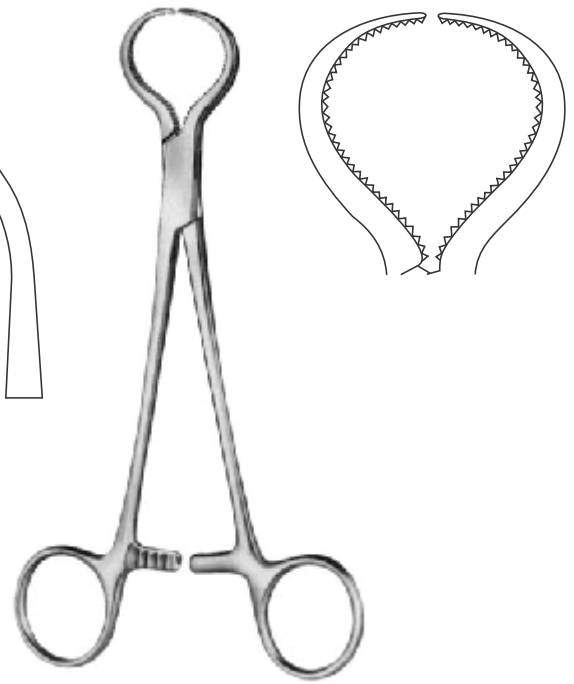

LEWIN
CM21-018
180 mm



PATELLA FORCEPS
CM21-019
185 mm

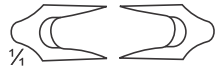

Forceps with
ratchet fixation
CM21-020
140 mm



CM21-021
120 mm



SETTER
CM21-022
135 mm



SETTER
CM21-023
170 mm

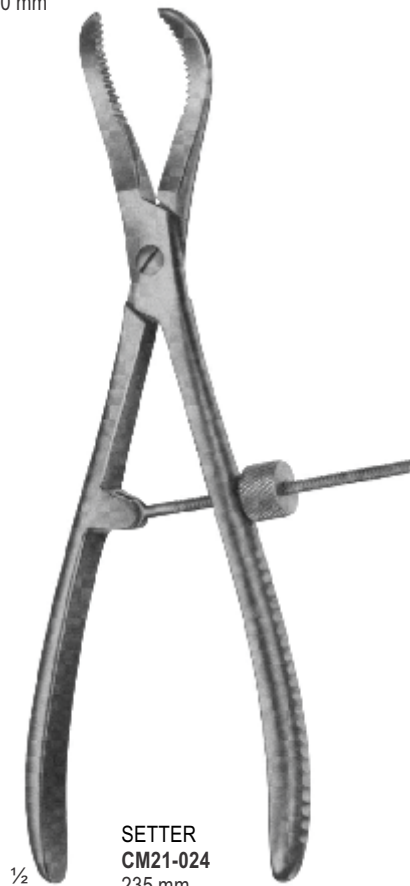

SETTER
CM21-024
235 mm

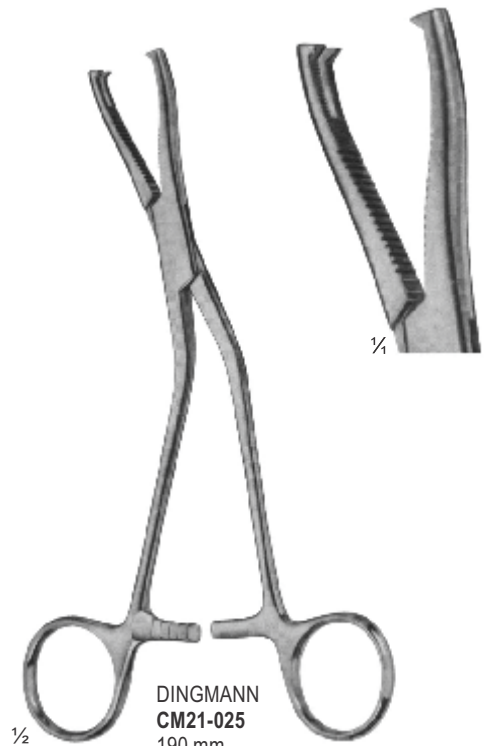

DINGMANN
CM21-025
190 mm

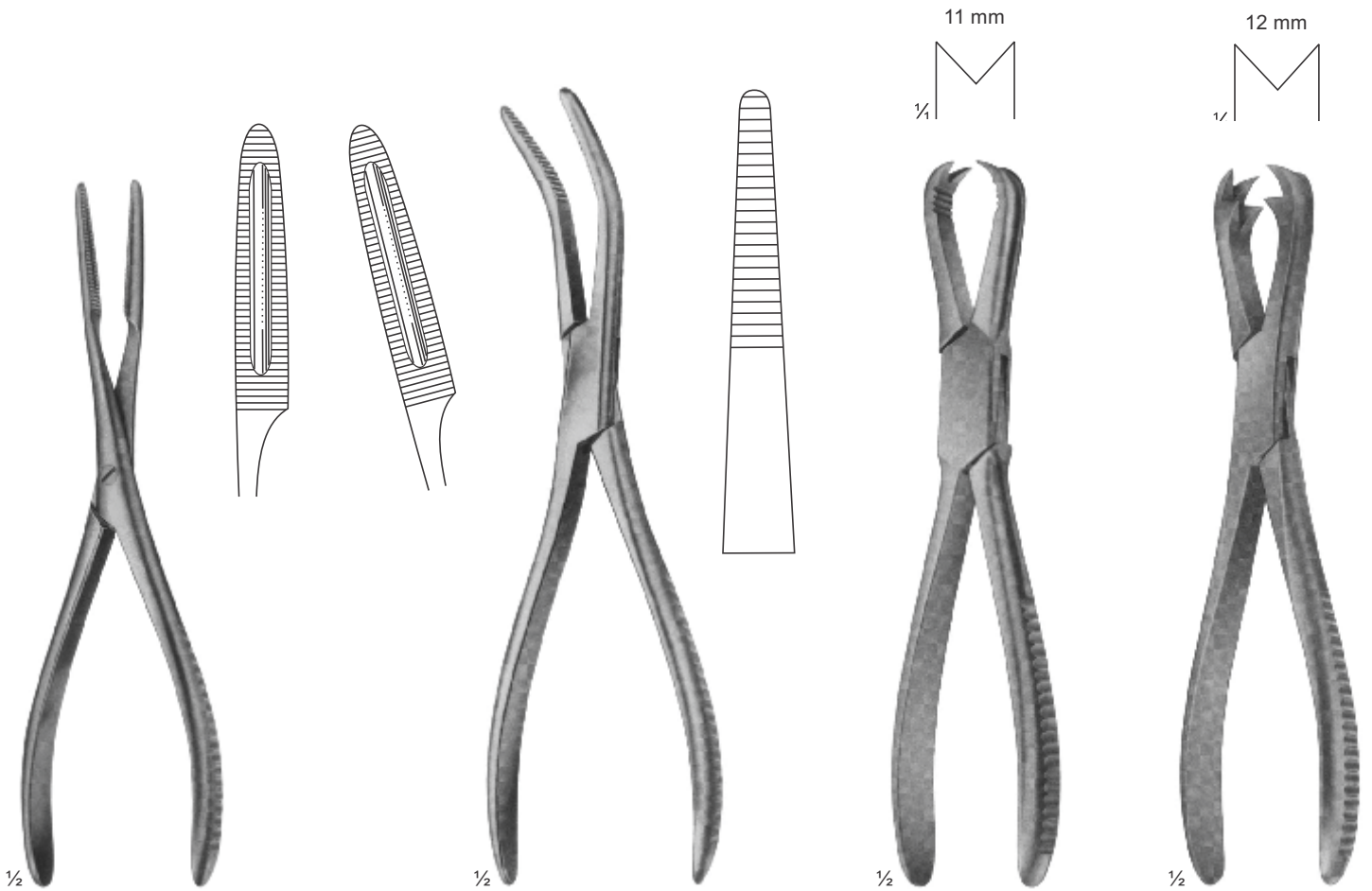

Sequestrum
forceps
CM21-026
200 mm

VAN BUREN
Sequestrum
forceps
CM21-027
230 mm

LANGENBECK
Sequestrum
forceps
CM21-028
205 mm

FERGUSON
CM21-029
205 mm

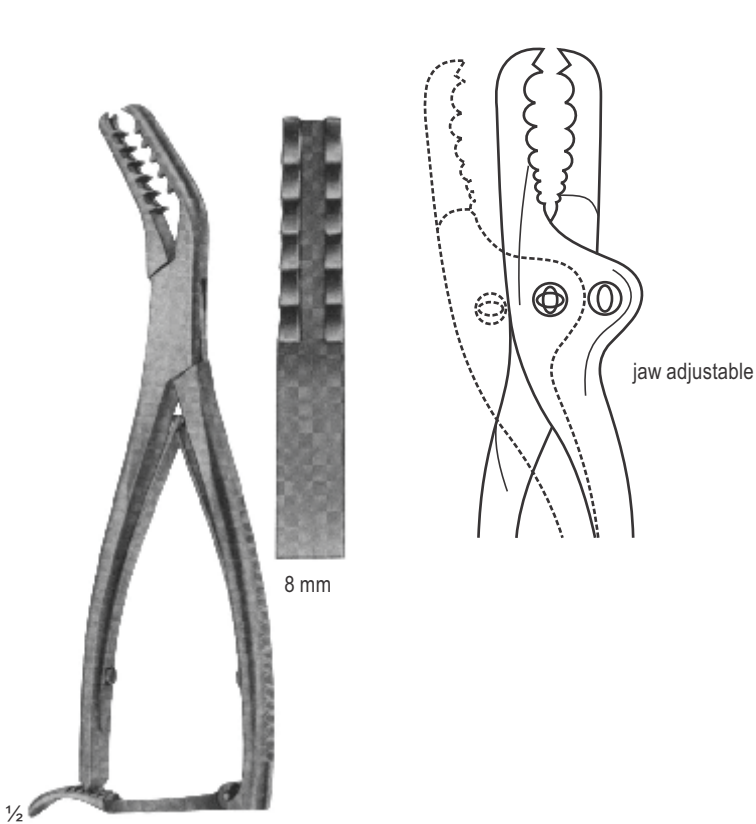

SEMB
CM21-030
190 mm

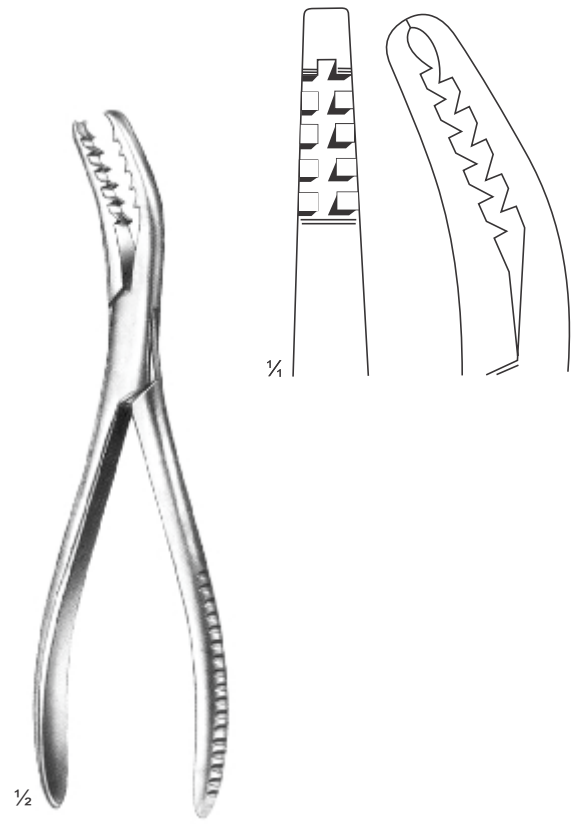

SEMB
CM21-031
195 mm

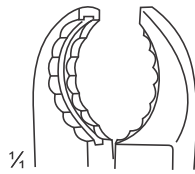
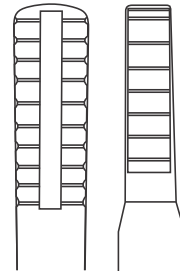
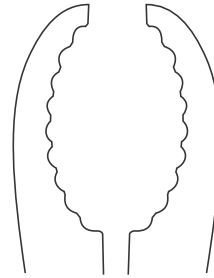
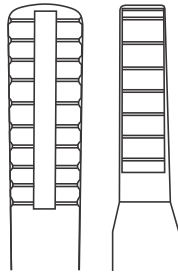
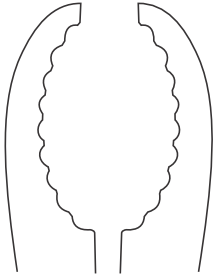

CM21-032
230 mm

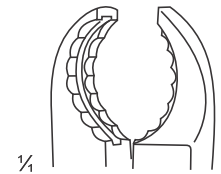

CM21-035
230 mm

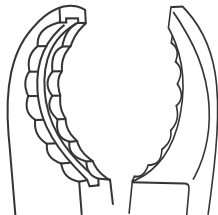

CM21-033
250 mm

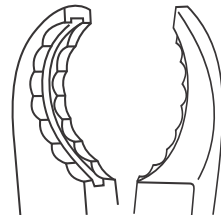

CM21-036
250 mm

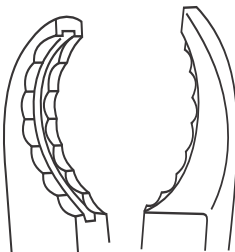

CM21-034
280 mm

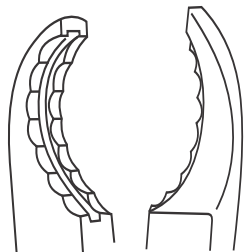

CM21-037
270 mm

ULRICH
CM21-032 - CM21-034
With thread Fixation

ULRICH
CM21-035 - CM21-037
With thread Fixation

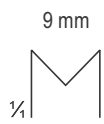

FARABEU
CM21-038
230 mm

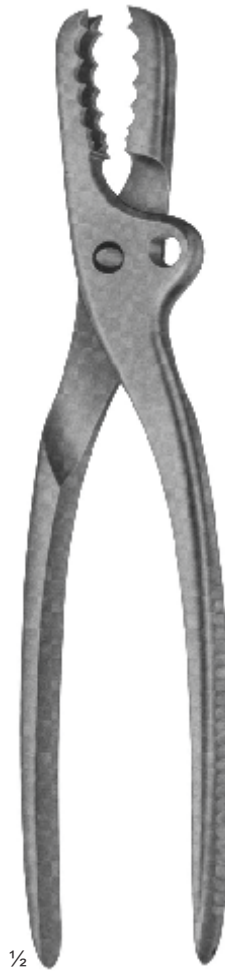
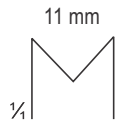

FARABEU
CM21-039
255 mm

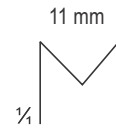

FARABEU-LAMBOTTE
CM21-040
255 mm

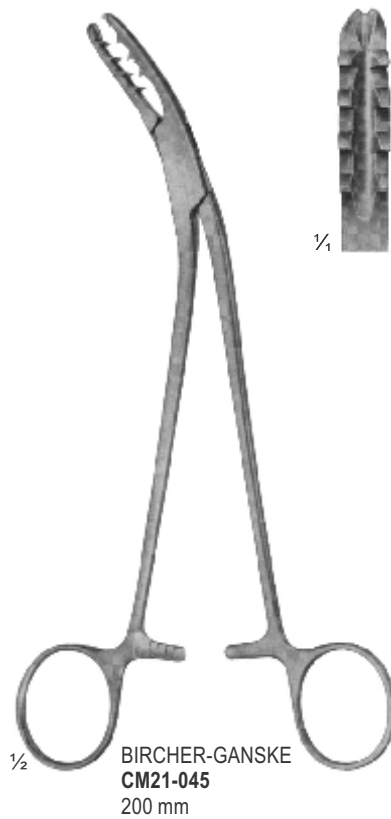
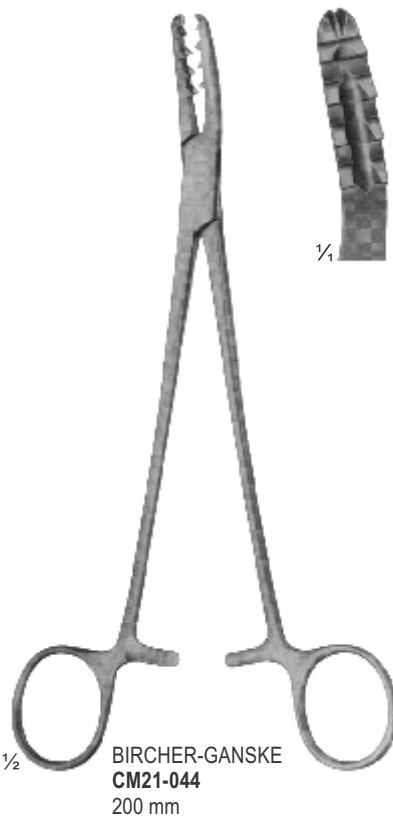
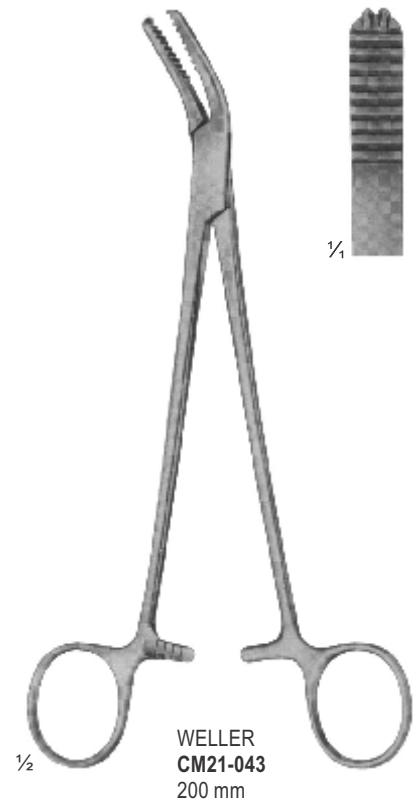
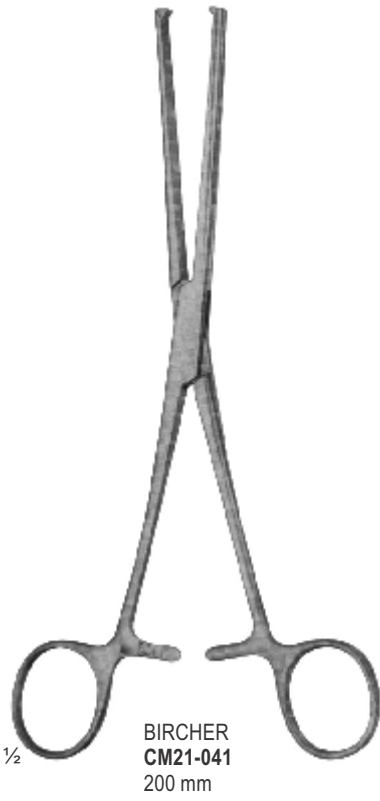



∅ 20 mm

½

CM21-047
MEAD
185 g
with interchangeable
plastic disks
190 mm
pair of spare disks



½

CM21-048
140 g
with interchangeable
plastic disks
185 mm
CM21-049
pair of spare disks



∅ 25 mm

½

CM21-050
COTTLE
140 g
1 Seite convex
1 Side convex
185 mm



∅ 22 mm

½

CM21-051
165 g
lead filled head
190 mm



HAJEK
140 g
CM21-052
215 mm



CM21-053
215 g
with interchangeable
plastic disks
245 mm
CM21-054
pair of spare disks

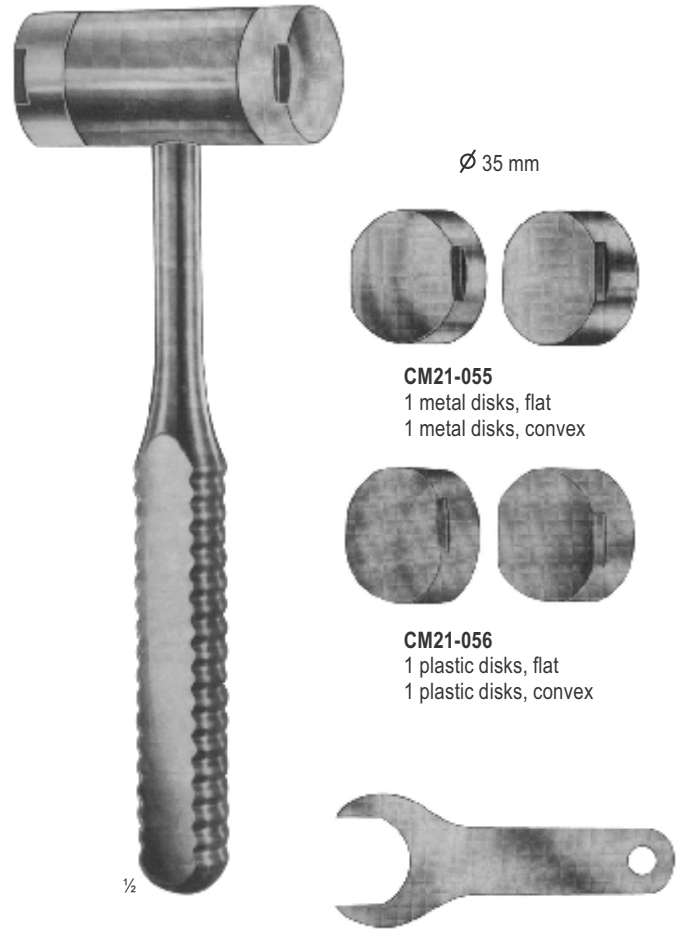

WAGNER
complete with:
1 pair of metal disks and
1 pair of plastic disks and
1 wrench 566
CM21-055 - CM21-057
235 mm



Wrench
CM21-057

Mallet without disks 130 g



BERGMANN
CM21-058
245 mm



BERGMANN
CM21-059
235 mm



OMBREDANNE
CM21-060
240 mm

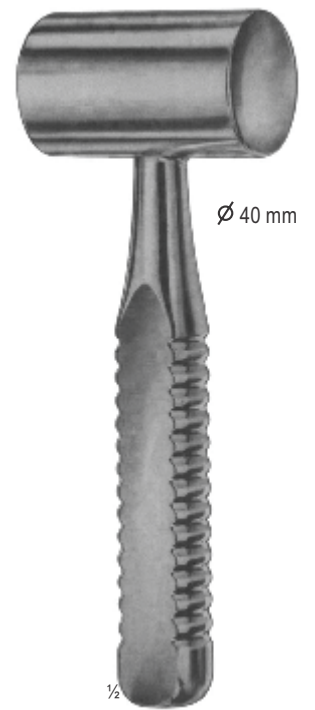

HEATH
copper filled head
700 g
CM21-061
185 mm



WILLIGER
CM21-062 - CM21-064
Lead Filled

CM21-062

Weight Head
275 g Ø 26 mm

CM21-063

Weight Head
320 g Ø 28 mm

CM21-064

Weight Head
340 g Ø 30 mm



DOYEN
CM21-065 - CM21-067

CM21-065

Weight Head
120 g Ø 25 mm

CM21-066

Weight Head
180 g Ø 30 mm

CM21-067

Weight Head
260 g Ø 35 mm



1/2

PARTSCH
CM21-068
With Hollow Handle
190 mm

Weight Head
175 g Ø27 mm



VIKERS
CM21-069
190 mm

Weight Head
185 g Ø25 mm



HERBERT
CM21-070
For Ulna Head Prosthesis
190 mm

Weight Head
215 g Ø25 mm

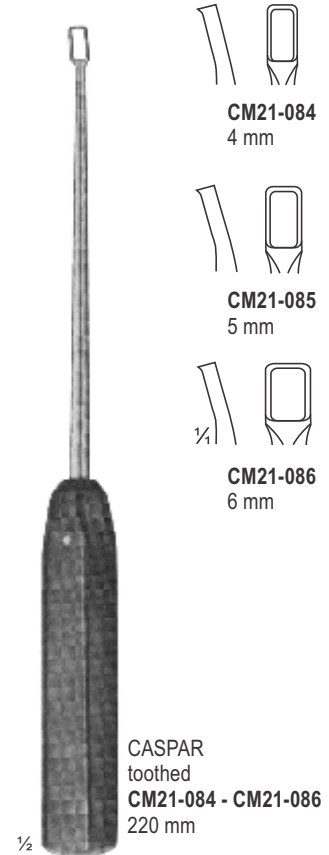
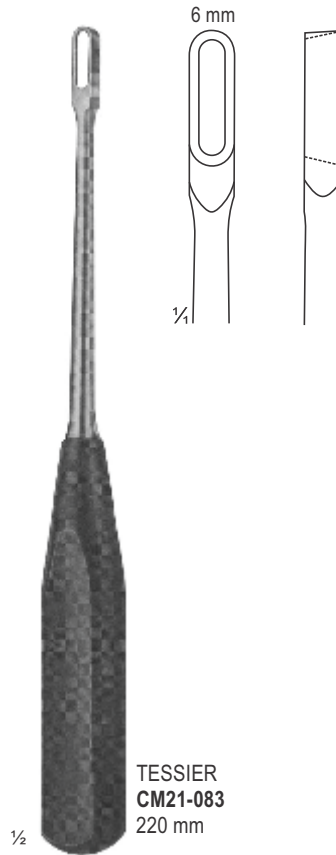
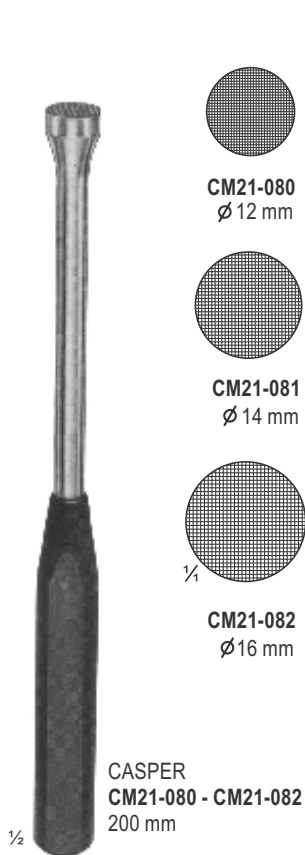
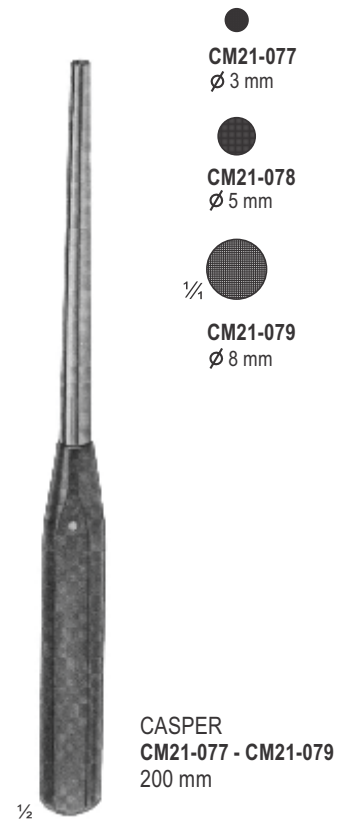
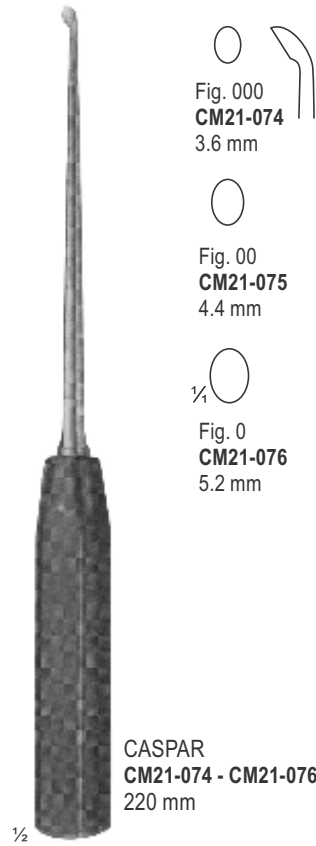
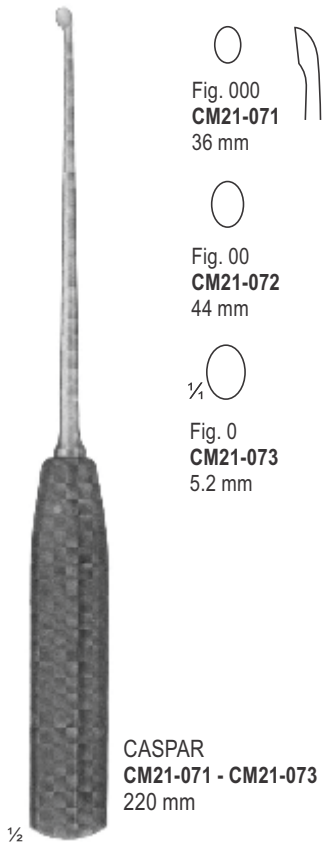

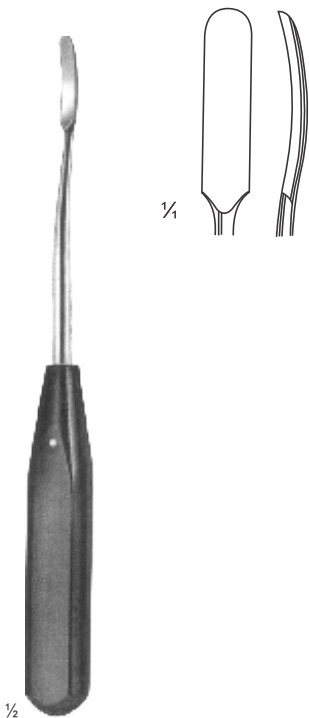

CM21-087
180 mm
6 mm

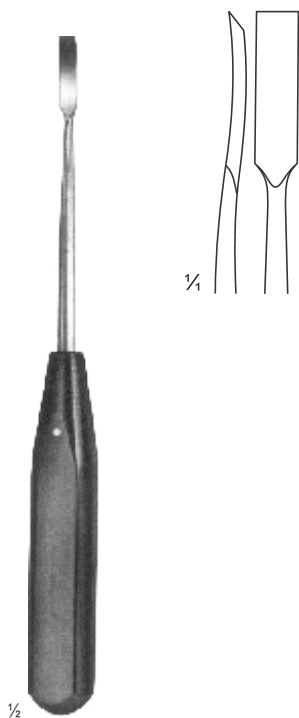

CM21-088
180 mm
6 mm

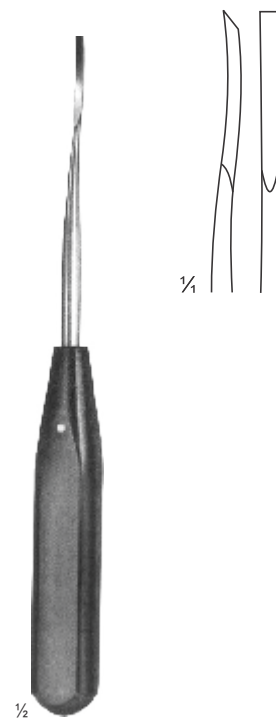

CM21-089
180 mm
3 mm

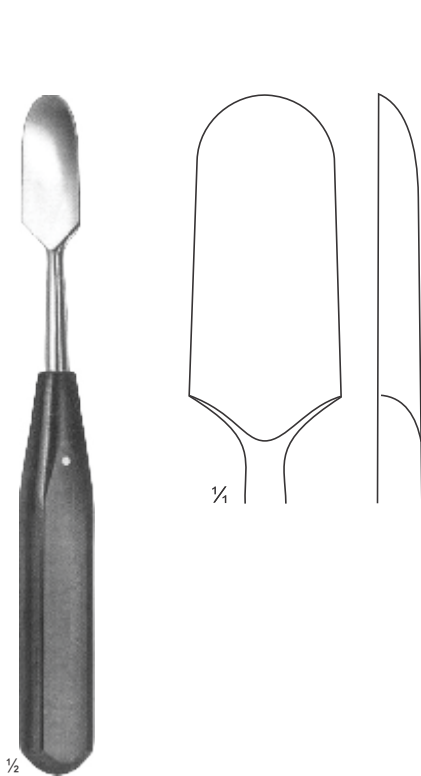

CM21-090
180 mm
20 mm

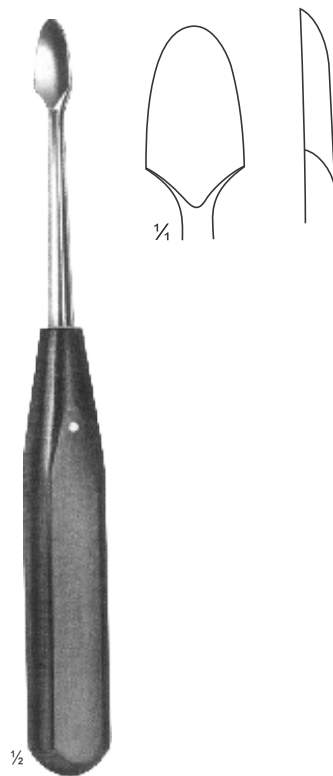

CM21-091
200 mm
14 mm

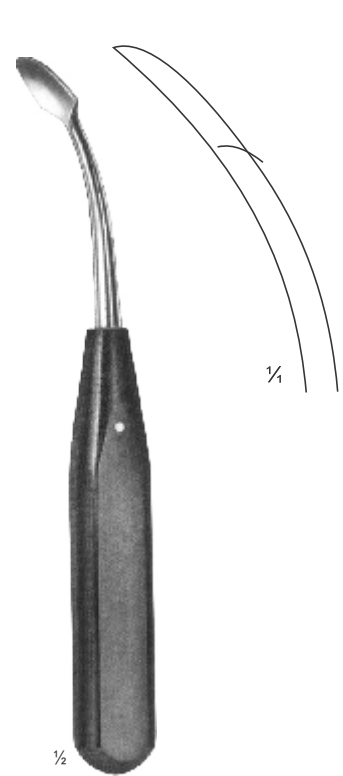

CM21-092
190 mm
14 mm

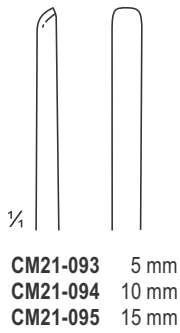

LEXER
CM21-093 - CM21-095
245 mm

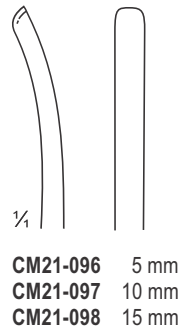

LEXER
CM21-096 - CM21-098
245 mm

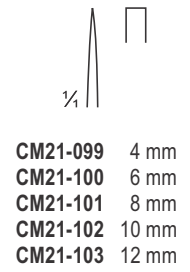

LEXER-MINI
CM21-099 - CM21-103
180 mm

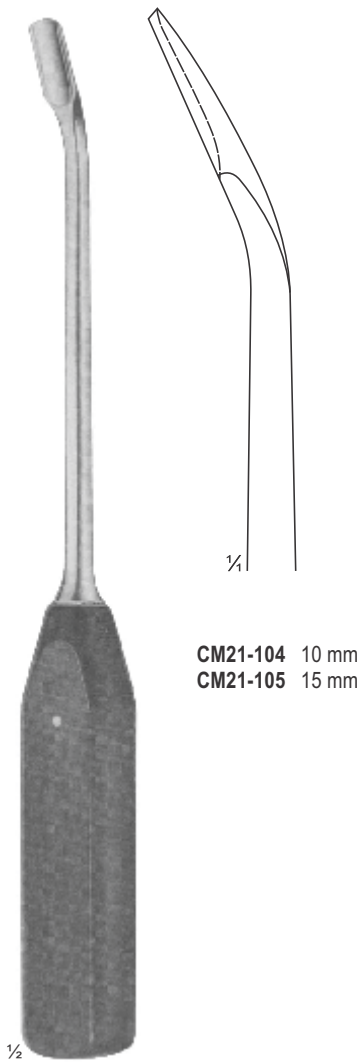

CM21-104 10 mm
CM21-105 15 mm

LEXER
CM21-104 - CM21-105
 Gouges,
 angled
 275 mm



1/4
 20 mm

Chisel
CM21-106
 245 mm

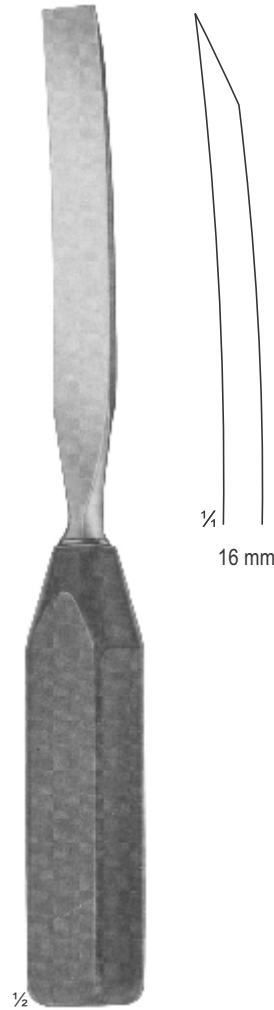

1/4
 16 mm

Chisel
 curved
CM21-107
 265 mm

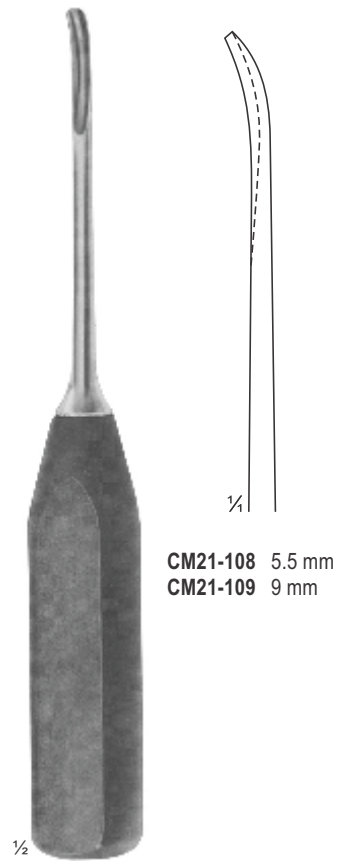

1/4
CM21-108 5.5 mm
CM21-109 9 mm

ZIELKE
CM21-108 - CM21-109
 Gouge for
 scoliose-operations
 230 mm



1/2

CM21-110 - CM21-113
270 mm

- 4.4 mm
Fig. 00
CM21-110
- 6.8 mm
Fig. 1
CM21-111
- 8.5 mm
Fig. 2
CM21-112
- 10 mm
Fig. 3
CM21-113



1/2

SYPERT
CM21-114 - CM21-121
380 mm

- | | |
|--|--|
| 2.8 mm
Fig. 0000
CM21-114 | 2.8 mm
Fig. 0000
CM21-118 |
| 3.6 mm
Fig. 000
CM21-115 | 3.6 mm
Fig. 000
CM21-119 |
| 5.2 mm
Fig. 0
CM21-116 | 5.2 mm
Fig. 0
CM21-120 |
| 10 mm
Fig. 3
CM21-117 | 10 mm
Fig. 3
CM21-121 |



CM21-122
200 mm



CM21-123
200 mm

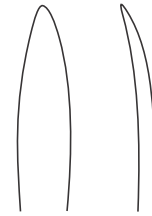

QUERVAIN
CM21-124
200 mm

LANGENBECK
CM21-122 - CM21-123



CM21-125
28 cm



COBB
CM21-125 - CM21-127



CM21-126
280 mm



CM21-127
280 mm



CM21-128 - CM21-133
CM21-128 170 mm
CM21-129 170 mm
CM21-130 170 mm
CM21-131 170 mm
CM21-132 190 mm
CM21-133 190 mm



1/2

- CM21-134**
3 mm
- CM21-135**
5 mm
- CM21-136**
6 mm
- CM21-137**
8 mm
- CM21-138**
9 mm

HOKE
CM21-134 - CM21-138
170 mm



1/2

- CM21-139**
6 mm
- CM21-140**
13 mm
- CM21-141**
19 mm
- CM21-142**
25 mm
- CM21-143**
32 mm

HIBBS
CM21-139 - CM21-143
245 mm



1/2

- CM21-144**
6 mm
- CM21-145**
13 mm
- CM21-146**
19 mm
- CM21-147**
25 mm
- CM21-148**
32 mm

HIBBS
CM21-144 - CM21-148
245 mm





- CM21-149**
6 mm
- CM21-150**
9 mm
- CM21-151**
13 mm
- CM21-152**
16 mm
- CM21-153**
19 mm
- CM21-154**
25 mm
- CM21-155**
32 mm

SMITH-PETERSEN
CM21-149 - CM21-155
205 mm



- CM21-156**
6 mm
- CM21-157**
9 mm
- CM21-158**
13 mm
- CM21-159**
16 mm
- CM21-160**
19 mm
- CM21-161**
25 mm
- CM21-162**
32 mm

SMITH-PETERSEN
CM21-156 - CM21-162
205 mm



- CM21-163**
9 mm
- CM21-164**
14 mm
- CM21-165**
19 mm
- CM21-166**
25 mm

SMITH-PETERSEN
CM21-163 - CM21-166
205 mm



- CM21-167**
9 mm
- CM21-168**
14 mm
- CM21-169**
19 mm
- CM21-170**
25 mm

SMITH-PETERSEN
CM21-167 - CM21-170
205 mm

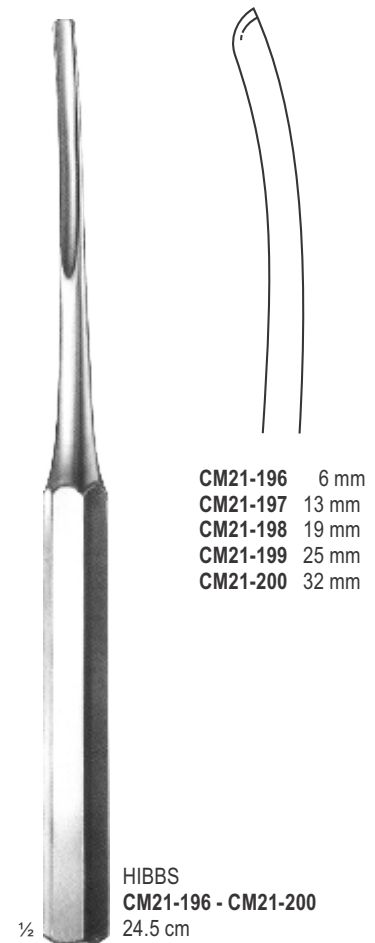
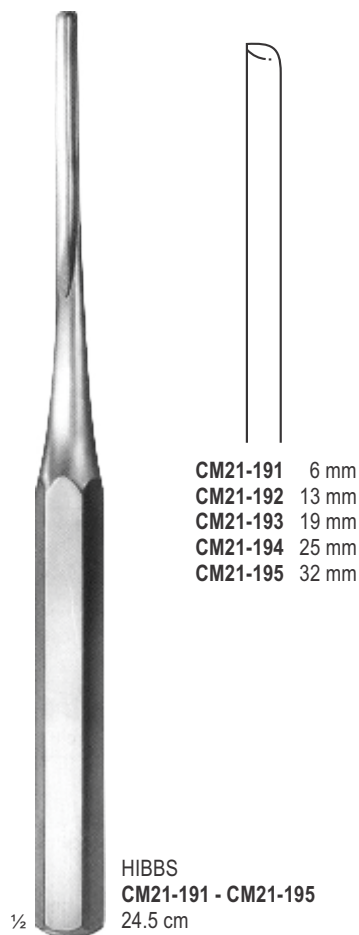
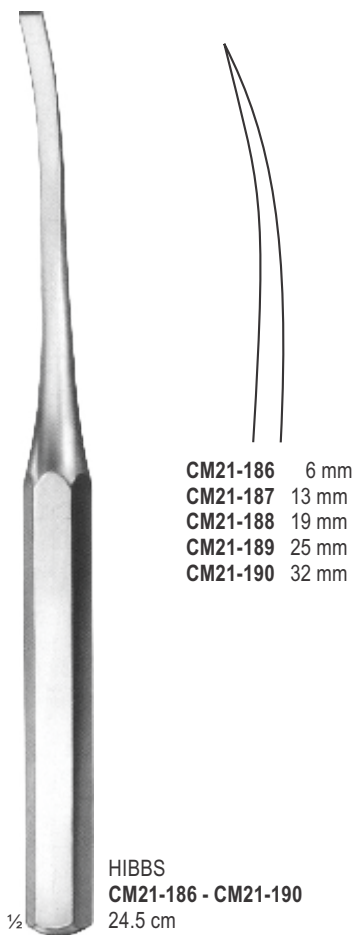
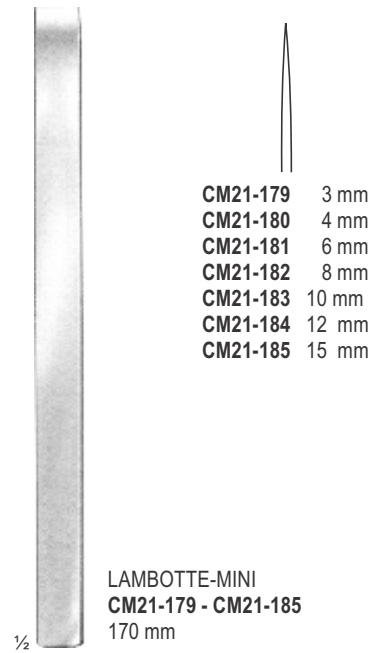
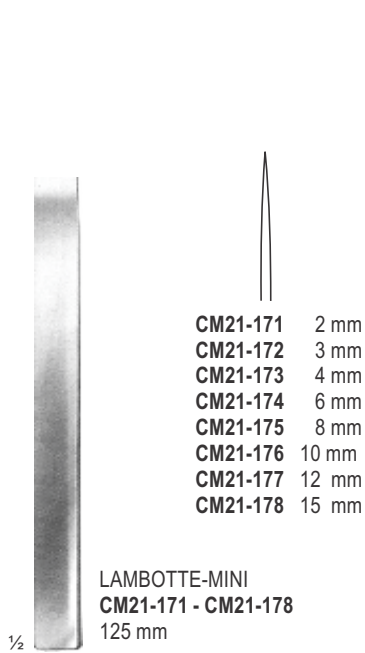



Haase
CM21-201
100 mm

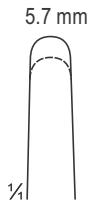

PASSOW
CM21-202 - CM21-203
120 mm

$\frac{1}{4}$ □
CM21-202
5.7 mm

$\frac{1}{4}$ □
CM21-203
3.5 mm



FREER
Chisel
CM21-204
160 mm



FREER
Chisel, curved
CM21-205
160 mm



FREER
Gouge
CM21-206
150 mm

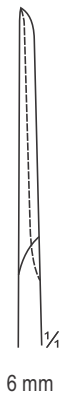

Scaphoid gouge,
downwards curved
CM21-207
135 mm



Scaphoid gouge,
upwards curved
CM21-208
135 mm



Mannerfelt
CM21-209 - CM21-211
CM21-209 4 mm
CM21-210 6 mm
CM21-211 8 mm
155 mm



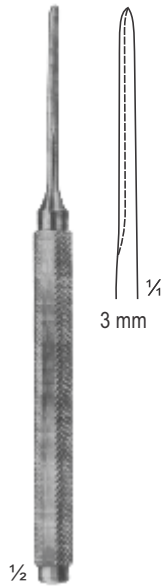

CM21-212
Mannerfelt
155 mm

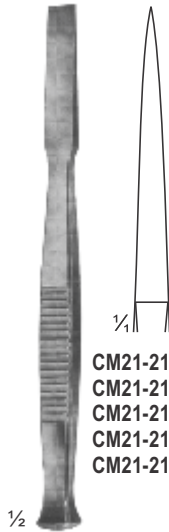

CM21-213 - CM21-217
Osteotome
140 mm

- CM21-213 4 mm
- CM21-214 6 mm
- CM21-215 8 mm
- CM21-216 10 mm
- CM21-217 12 mm

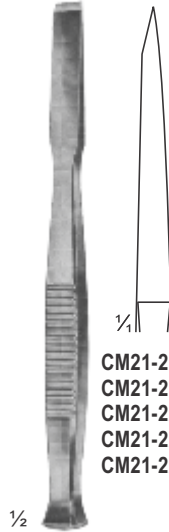

CM21-218 - CM21-222
Chisels
140 mm

- CM21-218 4 mm
- CM21-219 6 mm
- CM21-220 8 mm
- CM21-221 10 mm
- CM21-222 12 mm

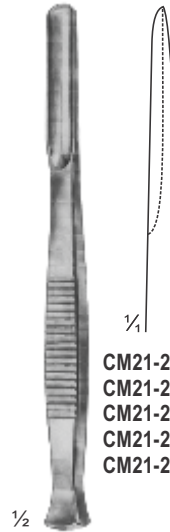

CM21-223 - CM21-227
Gouges
140 mm

- CM21-223 4 mm
- CM21-224 6 mm
- CM21-225 8 mm
- CM21-226 10 mm
- CM21-227 12 mm

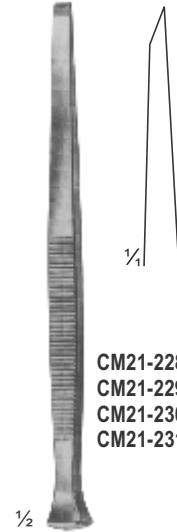

PARTSCH
CM21-228 - CM21-231
CHISELS
140 mm

- CM21-228 3 mm
- CM21-229 4 mm
- CM21-230 5 mm
- CM21-231 6 mm

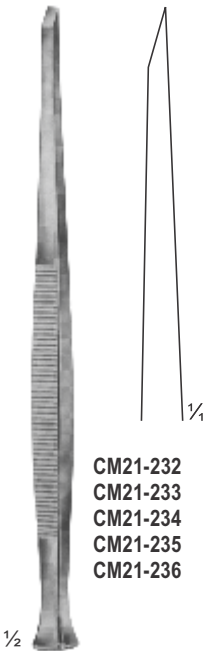

PARTSCH
CM21-232 - CM21-236
Chisels
170 mm

- CM21-232 3 mm
- CM21-233 4 mm
- CM21-234 5 mm
- CM21-235 6 mm
- CM21-236 7 mm

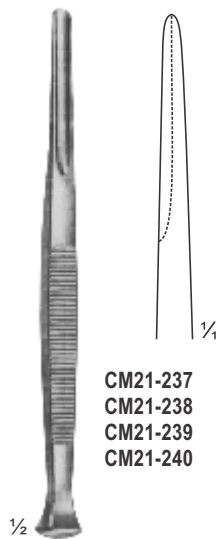

PARTSCH
CM21-237 - CM21-240
Gouges
140 mm

- CM21-237 3 mm
- CM21-238 4 mm
- CM21-239 5 mm
- CM21-240 6 mm

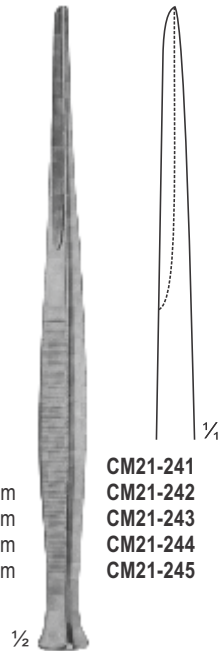

PARTSCH
CM21-241 - CM21-245
Gouges
170 mm

- CM21-241 3 mm
- CM21-242 4 mm
- CM21-243 5 mm
- CM21-244 6 mm
- CM21-245 7 mm

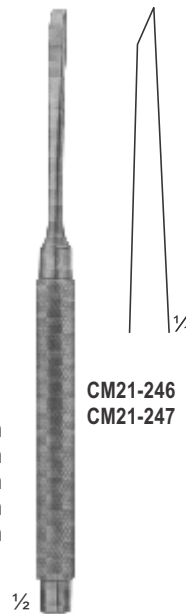

LUCAS
CM21-246 - CM21-247
Chisels
160 mm

- CM21-246 4 mm
- CM21-247 6 mm

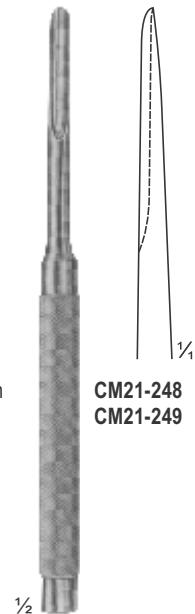

LUCAS
CM21-248 - CM21-249
Gouges
160 mm

- CM21-248 3 mm
- CM21-249 5 mm

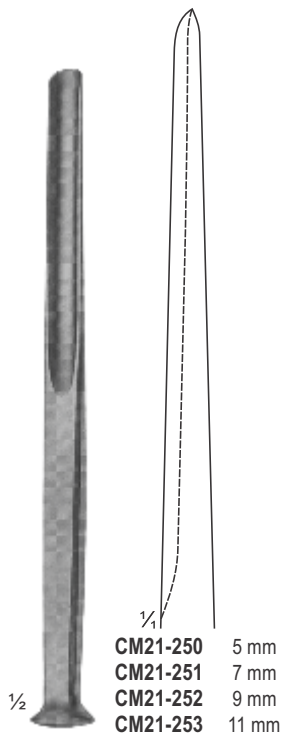

ALEXANDER
CM21-250 - CM21-253
 Gouges
 170 mm

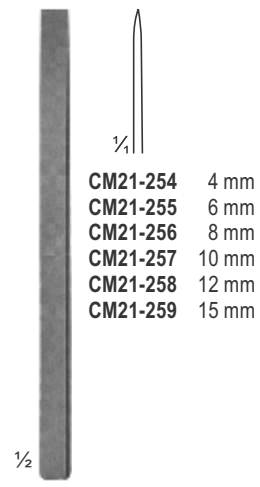

LAMBOTTE
CM21-254 - CM21-259
 Osteotome
 125 mm

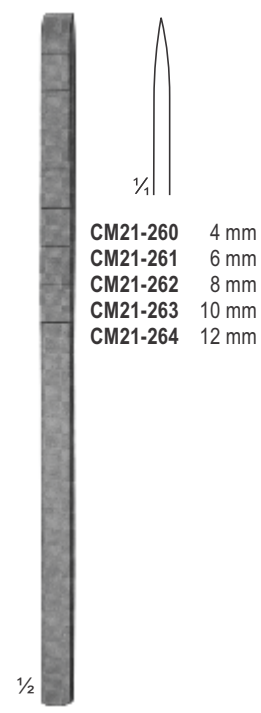

COTTLE
CM21-260 - CM21-264
 Osteotome with depth markings
 180 mm

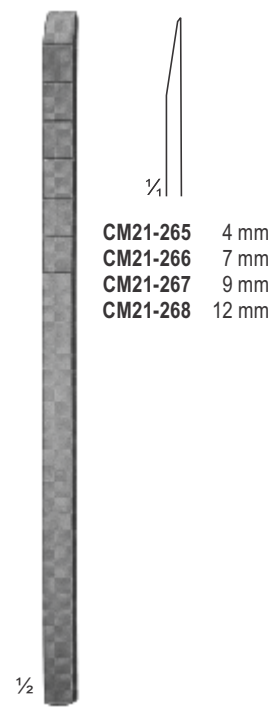

COTTLE
CM21-265 - CM21-268
 Chisel-Osteotomes with depth markings
 180 mm



COTTLE
CM21-269
 Fishtail Chisel, with protected ends
 180 mm

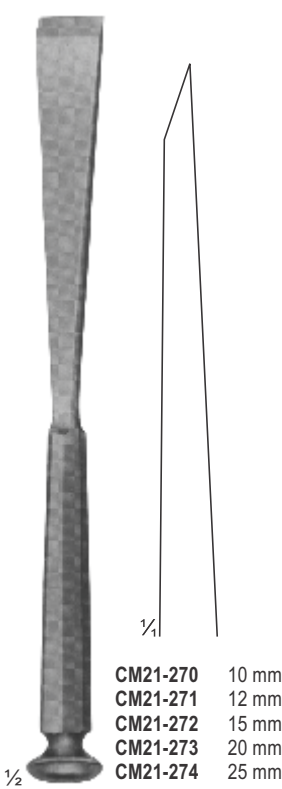

STILLE
CM21-270 - CM21-274
 Chisels
 205 mm

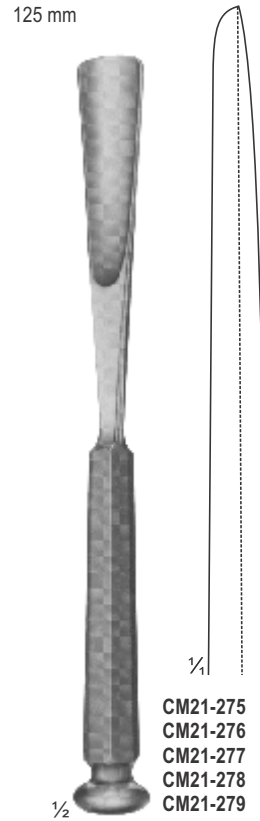

STILLE
CM21-275 - CM21-279
 Gouges
 205 mm

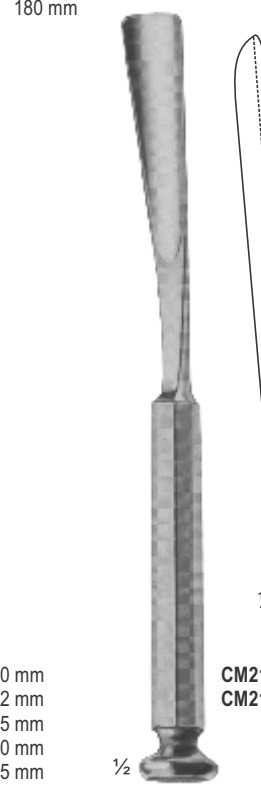

WALTER
CM21-280 - CM21-281
 Osteotomes gouges for taking grafts from the rib

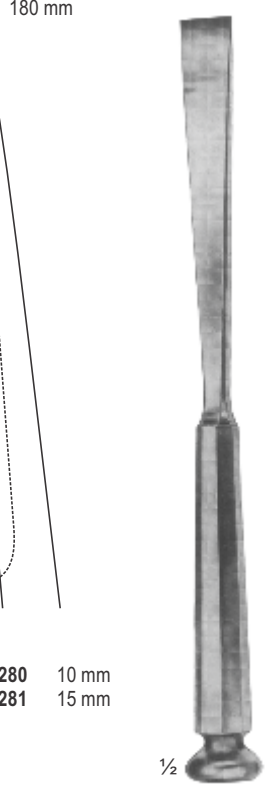

STILLE
CM21-282 - CM21-286
 Osteotomes
 205 mm

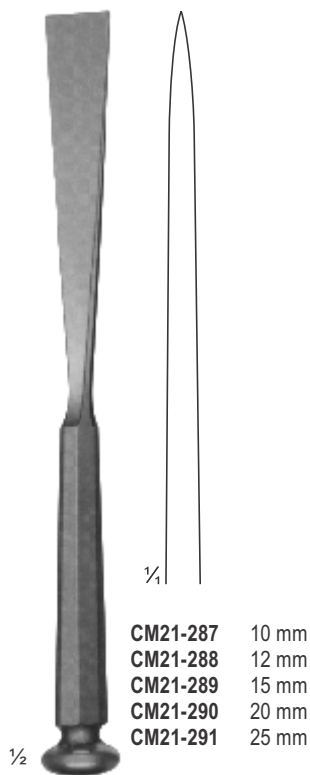

STILLE
CM21-287 - CM21-291
Osteotomes
205 mm

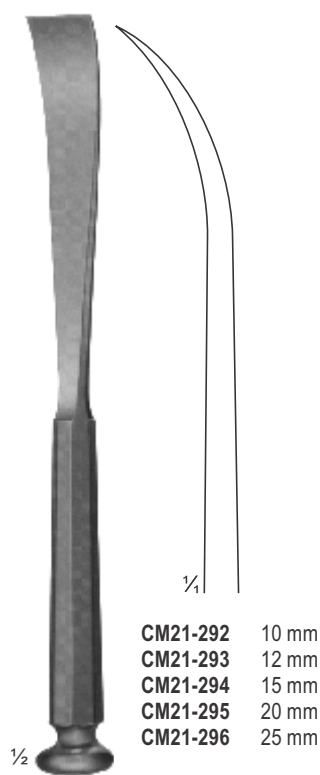

STILLE
CM21-292 - CM21-296
Osteotomes, curved
205 mm

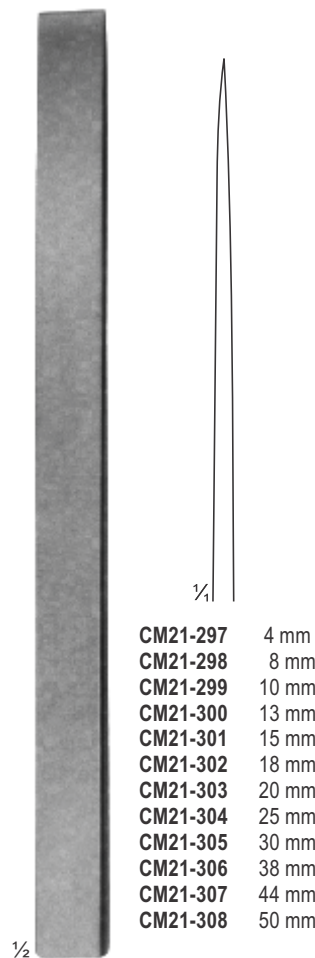

LAMBOTTE
CM21-297 - CM21-308
Osteotomes
245 mm

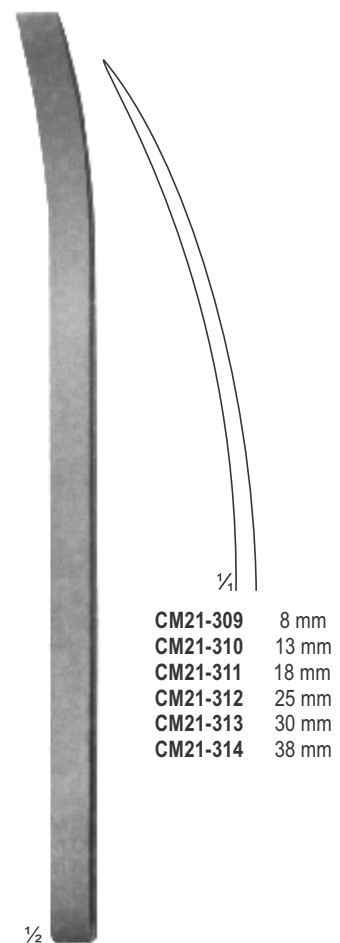

LAMBOTTE
CM21-309 - CM21-314
Osteotomes, curved
245 mm

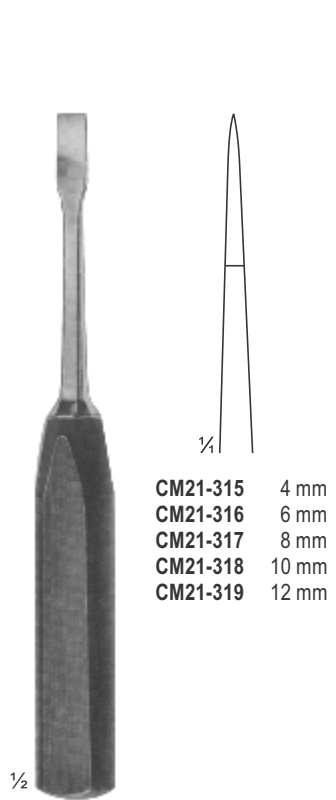

- CM21-315 4 mm
- CM21-316 6 mm
- CM21-317 8 mm
- CM21-318 10 mm
- CM21-319 12 mm

LEXER-MINI
CM21-315 - CM21-319
Osteotomes
180 mm

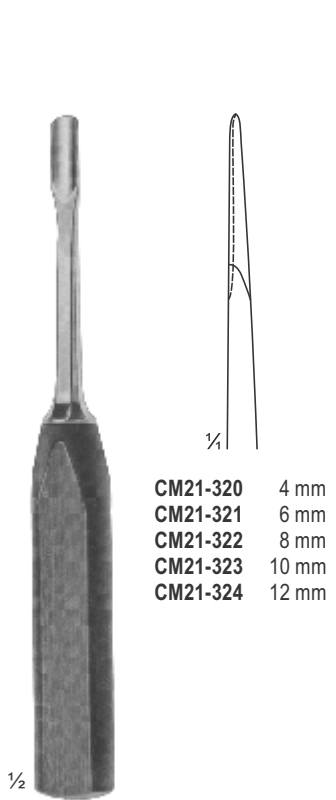

- CM21-320 4 mm
- CM21-321 6 mm
- CM21-322 8 mm
- CM21-323 10 mm
- CM21-324 12 mm

LEXER-MINI
CM21-320 - CM21-324
Gouges
180 mm

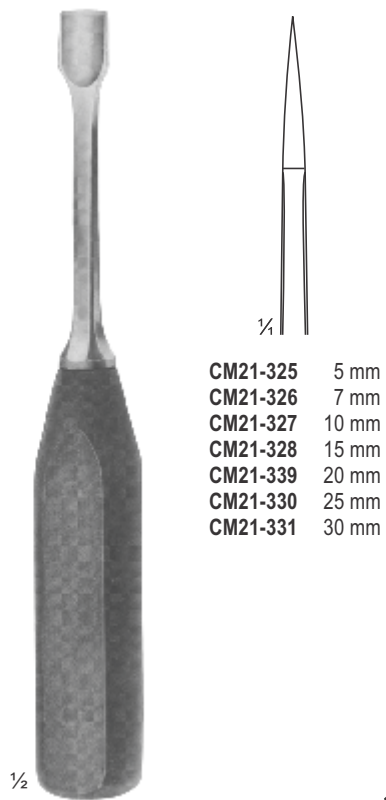

- CM21-325 5 mm
- CM21-326 7 mm
- CM21-327 10 mm
- CM21-328 15 mm
- CM21-339 20 mm
- CM21-330 25 mm
- CM21-331 30 mm

LEXER
CM21-325 - CM21-331
Osteotomes
220 mm

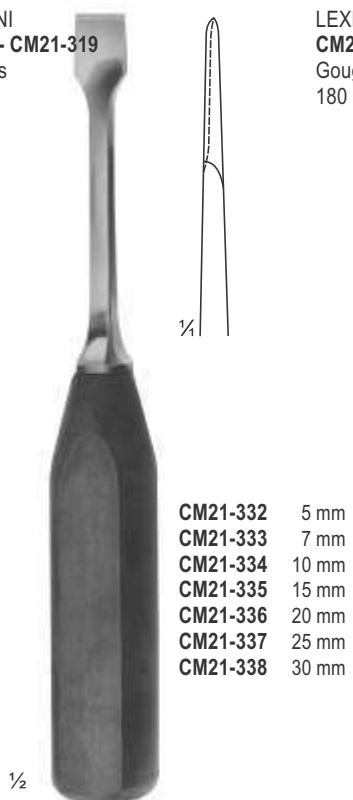

- CM21-332 5 mm
- CM21-333 7 mm
- CM21-334 10 mm
- CM21-335 15 mm
- CM21-336 20 mm
- CM21-337 25 mm
- CM21-338 30 mm

LEXER
CM21-332 - CM21-338
Gouges
220 mm

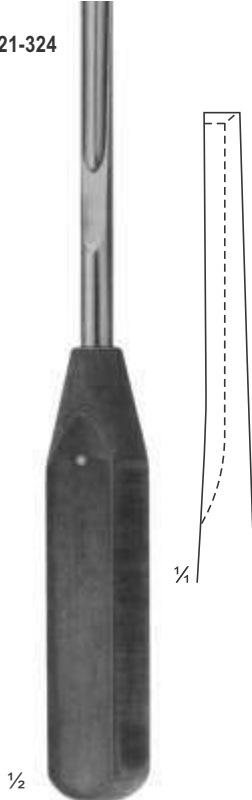

LEXER
CM21-339
Gouge for
removing broken
screws

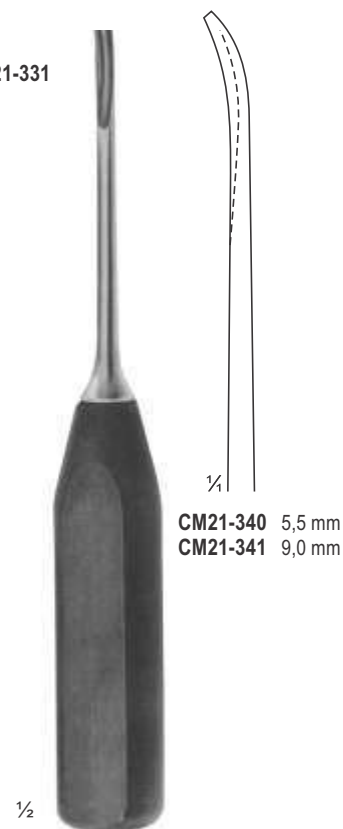

- CM21-340 5,5 mm
- CM21-341 9,0 mm

ZIELKE
CM21-340 - CM21-341
Gouge for
scoliose-operations
230 mm

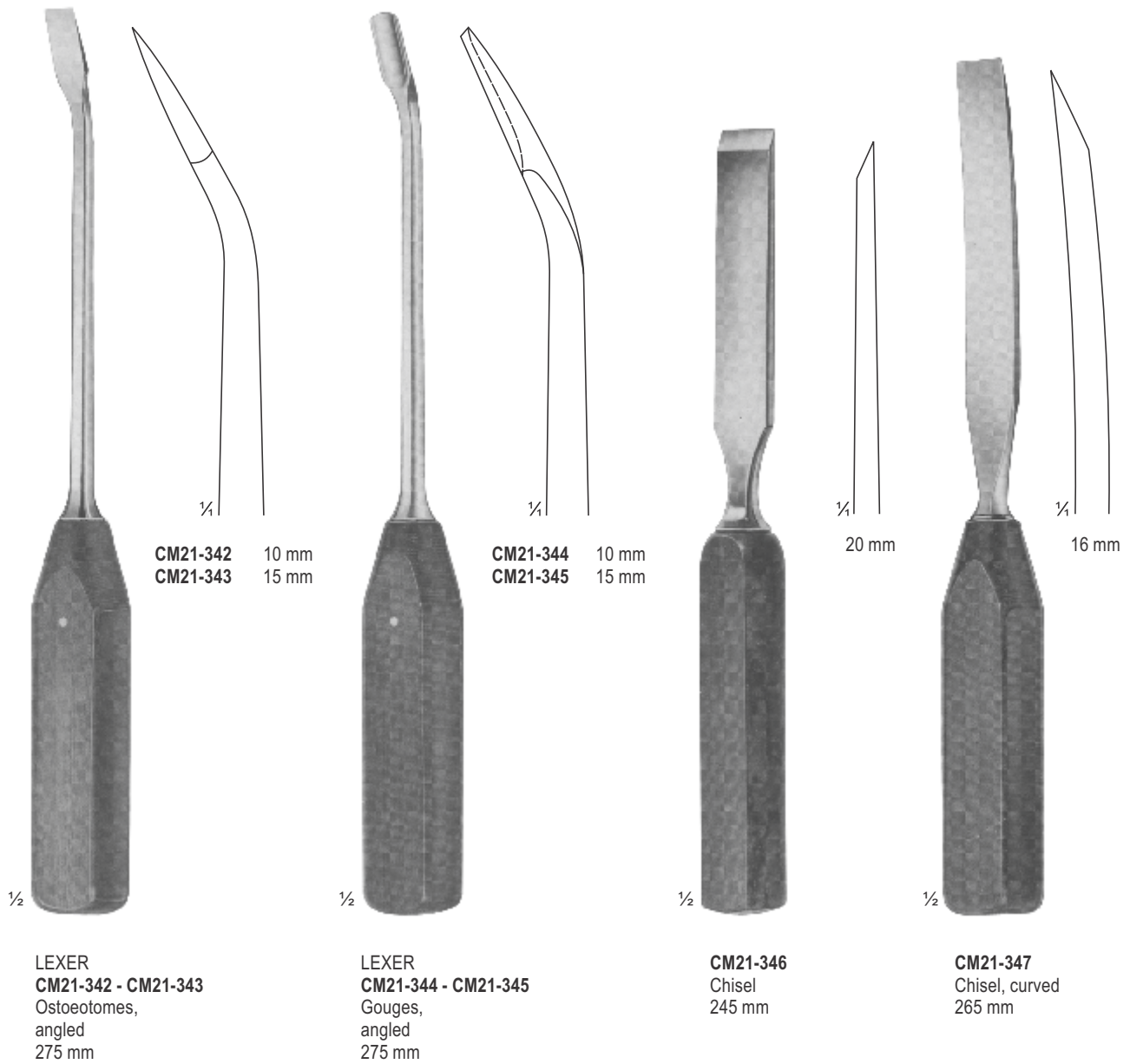

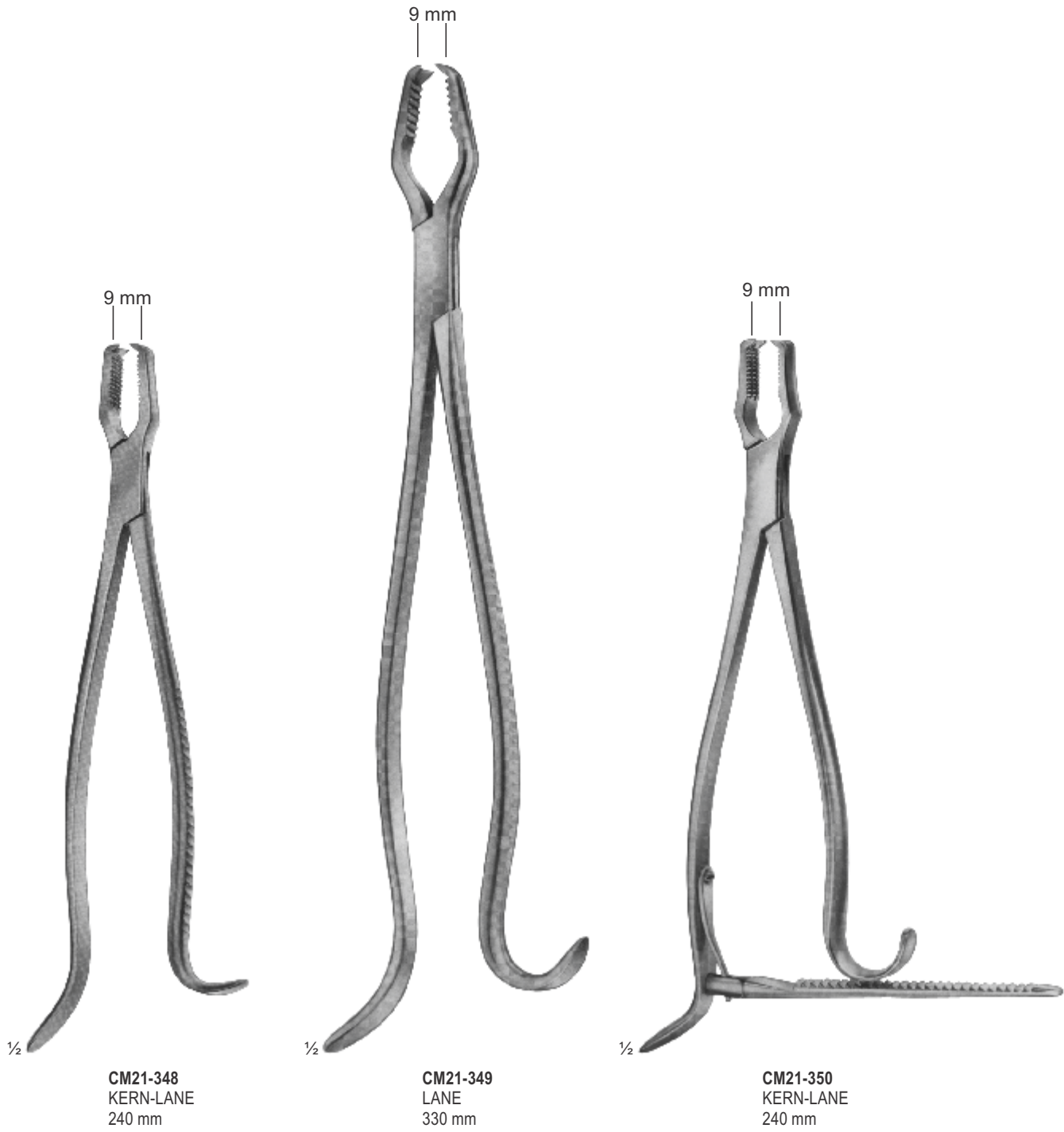



1/2 **CM21-351 - CM21-355**

- CM21-351** 145 mm
- CM21-352** 190 mm
- CM21-353** 240 mm
- CM21-354** 260 mm
- CM21-355** 280 mm

Self-centering forceps
with thread fixation

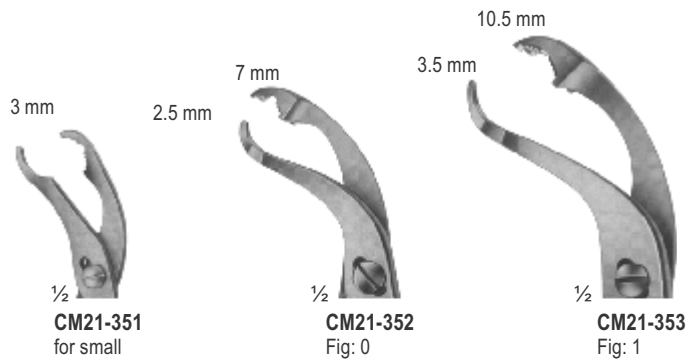

1/2 **CM21-351**
for small
fragments

1/2 **CM21-352**
Fig: 0

1/2 **CM21-353**
Fig: 1

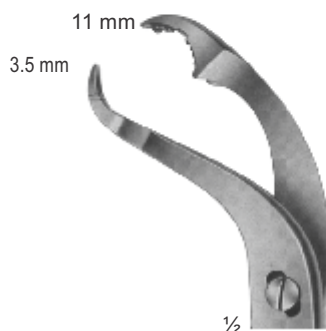

1/2 **CM21-354**
Fig: 2

1/2 **CM21-355**
Fig: 3



1/2 **CM21-356 - CM21-358**
VERBRUGGE
with lip joint

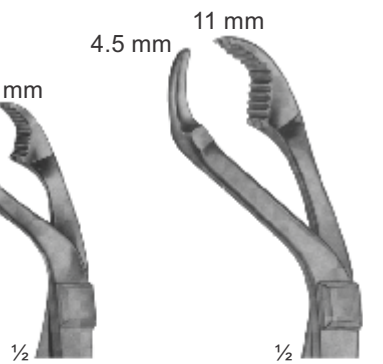

1/2 **CM21-356**
Fig: 1

1/2 **CM21-357**
Fig: 2



1/2 **CM21-358**
Fig: 3



1/2 **CM21-359**
LAMBOTTE
265 mm



1/2

CM21-360 - CM21-361
LOWMAN
CM21-360 170 mm
CM21-361 205 mm

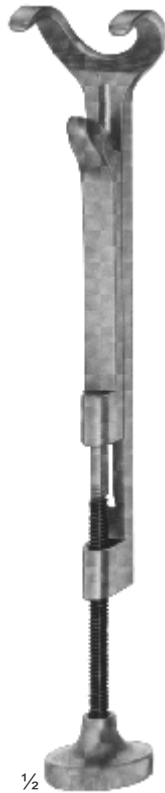

1/2

CM21-362
LOWMAN-GERSTER
210 mm

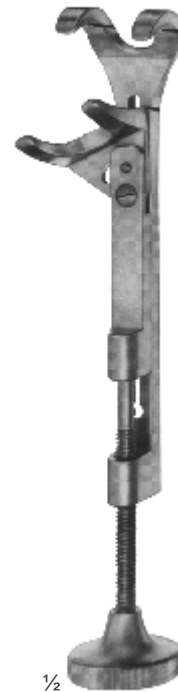

1/2

CM21-363
LOWMAN-HOGLUND
175 mm

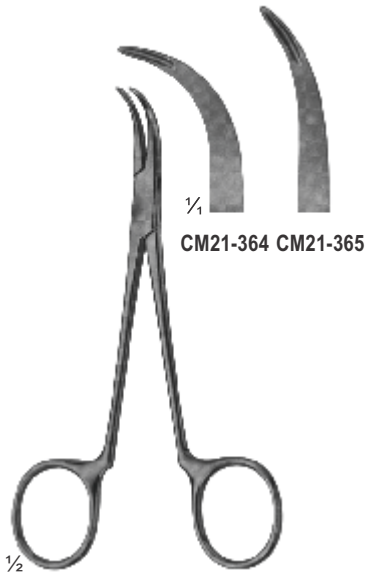

CM21-364 CM21-365

CM21-364 - CM21-365
Synovectomy rongeur
width of jaws 1.2 mm
130 mm

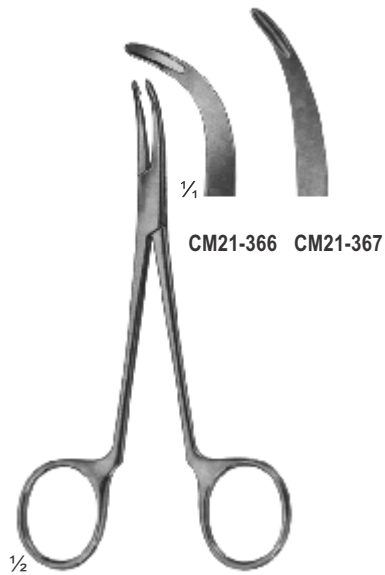

CM21-366 CM21-367

CM21-366 - CM21-367
Synovectomy rongeur
width of jaws 2.0 mm
130 mm

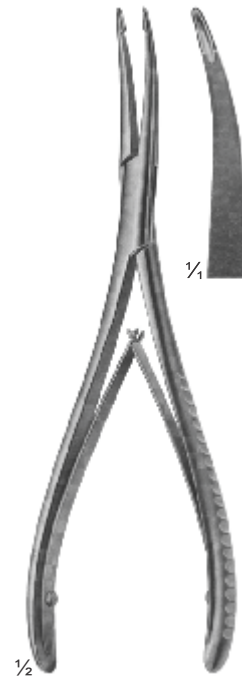

CM21-368
STELLBRINK
Synovectomy rongeur
175 mm

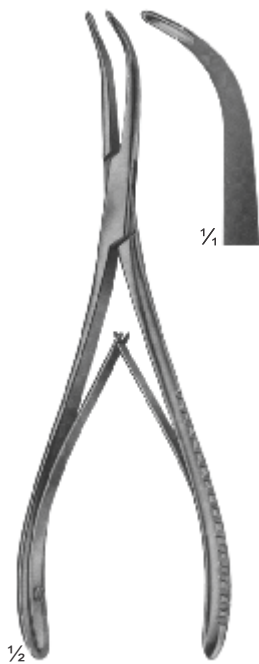

CM21-369
STELLBRINK
Synovectomy rongeur
170 mm



CM21-370
LURE-FRIEDMANN
145 mm

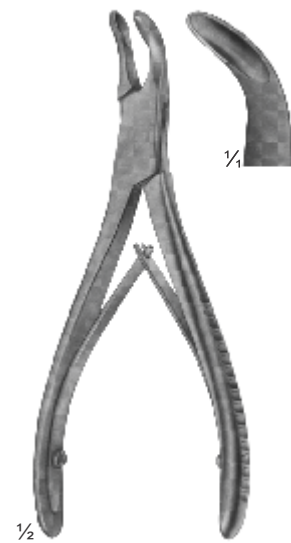

CM21-371
140 mm



CM21-372
LURE
150 mm

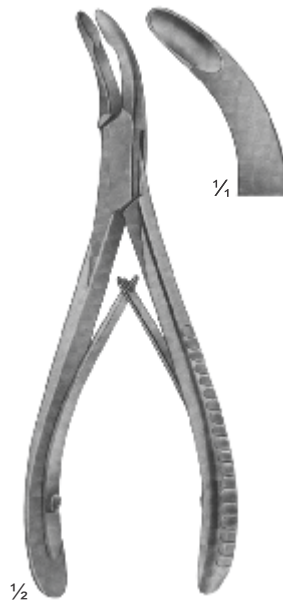

CM21-373
LURE
155 mm

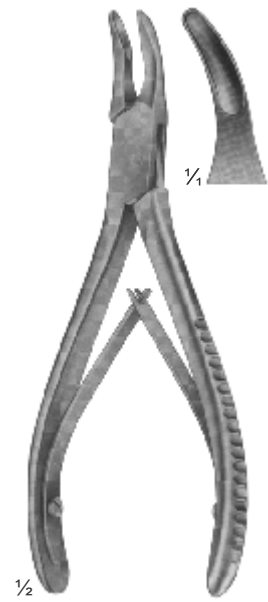

CM21-374
BLUMENTHAL
155 mm

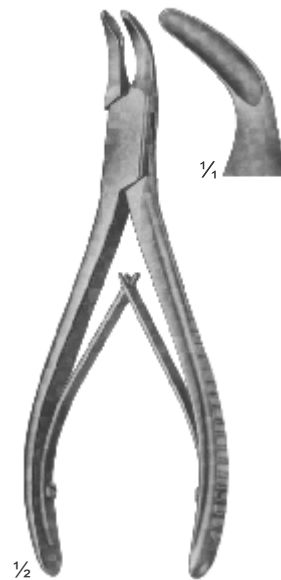

CM21-375
BLUMENTHAL
150 mm

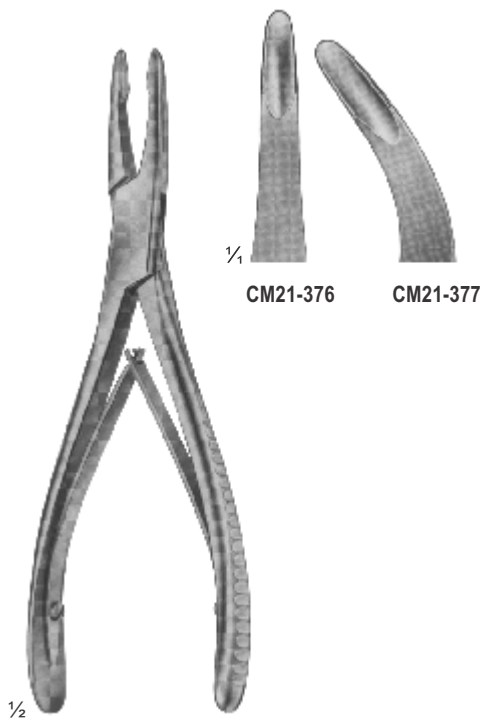

CM21-376 - CM21-377
JANSEN
175 mm

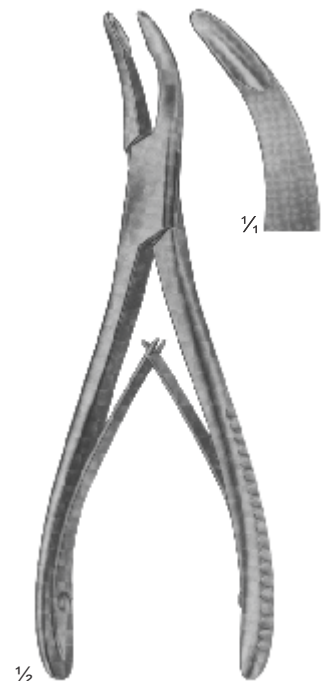

CM21-378
BANE-HARTMANN
175 mm

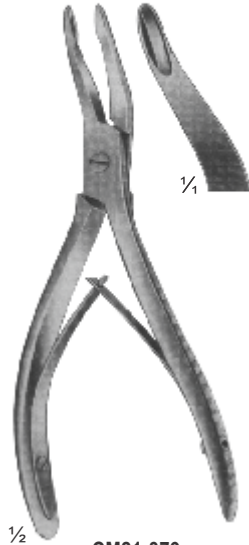

$\frac{1}{2}$
CM21-379
ALEXANDER
140 mm

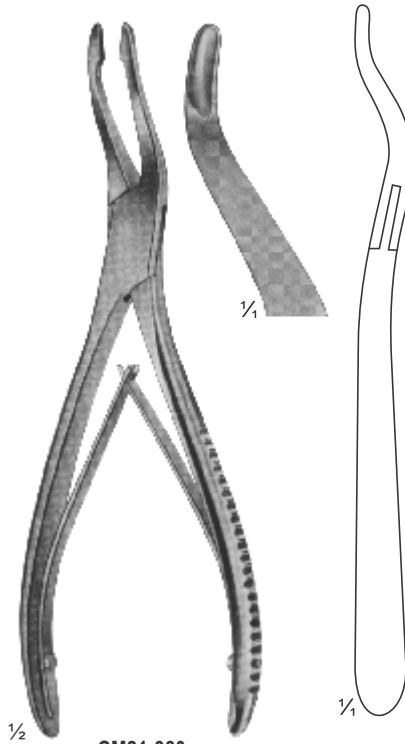

$\frac{1}{2}$
CM21-380
JANSEN
190 mm

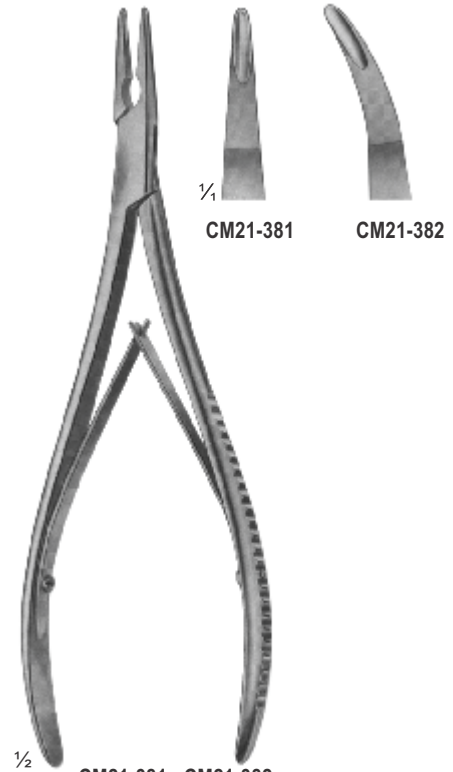

$\frac{1}{2}$
CM21-381 - CM21-382
LEMPERT
200 mm

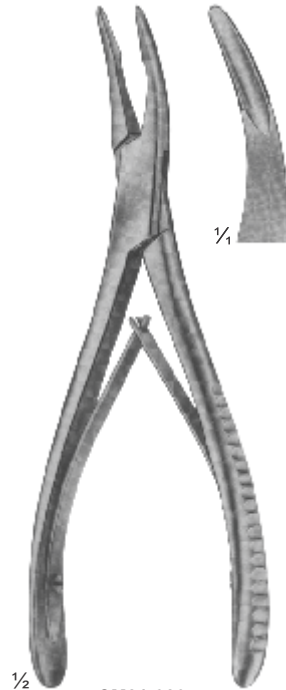

$\frac{1}{2}$
CM21-383
BEYER
180 mm

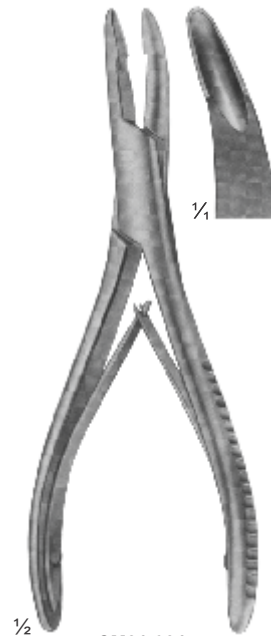

$\frac{1}{2}$
CM21-384
MEAD
165 mm

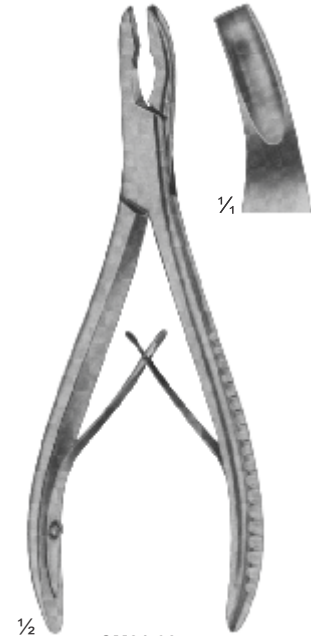

$\frac{1}{2}$
CM21-385
MEAD
165 mm

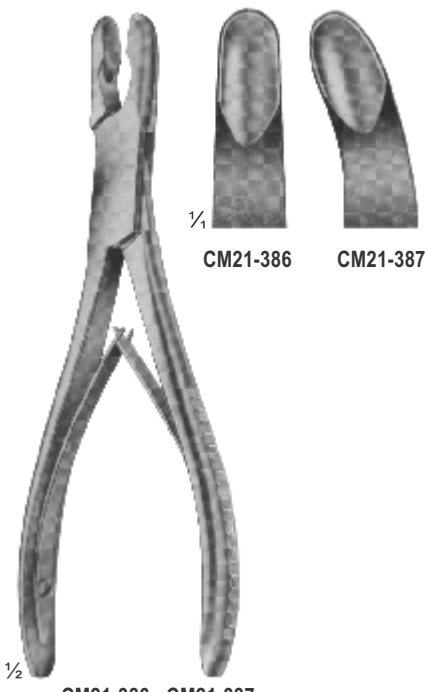

CM21-386 CM21-387

CM21-386 - CM21-387
LURE
175 mm

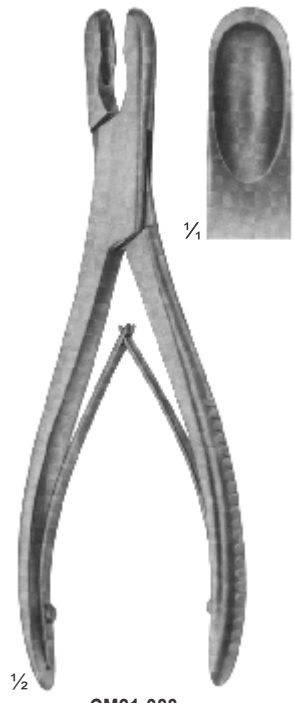

CM21-388
LURE
180 mm

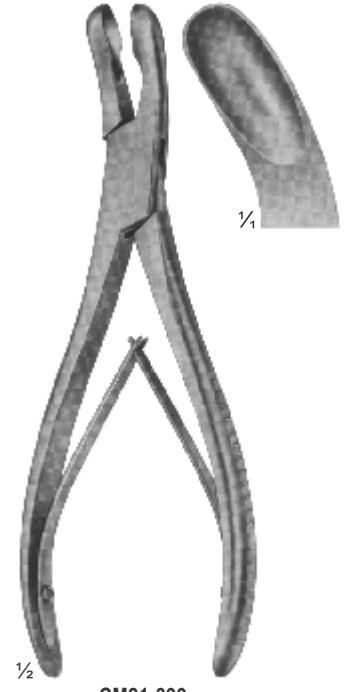

CM21-399
LURE
180 mm

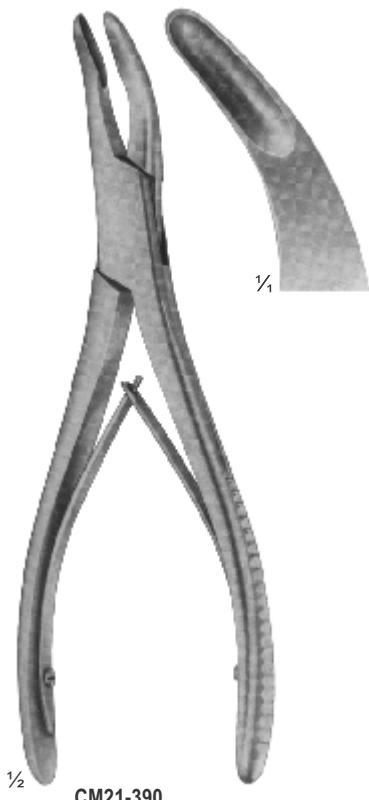

CM21-390
OLIVECRONA
205 mm



CM21-391 - CM21-392
BOHLER
155 mm

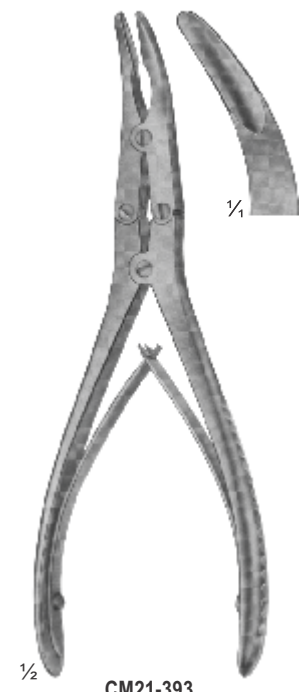

CM21-393
MARQUARTD
200 mm

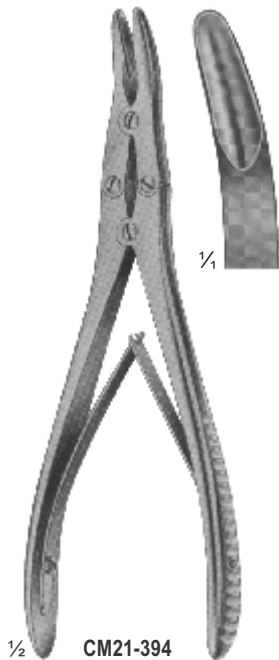

1/2 **CM21-394**
RUSKIN
190 mm



1/2 **CM21-395**
ROTTGEN-RUSKIN
240 mm

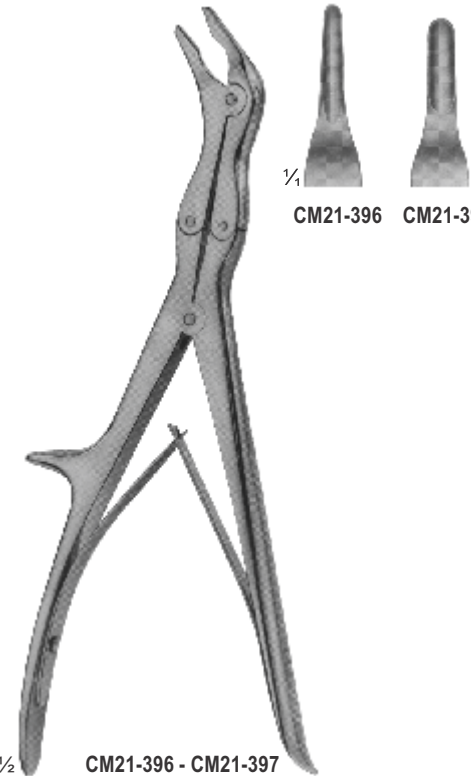

1/2 **CM21-396 - CM21-397**
ECHLIN
230 mm



1/2 **CM21-398**
STILLE
235 mm



1/2 **CM21-399**
LEKSELL-STILLE
240mm

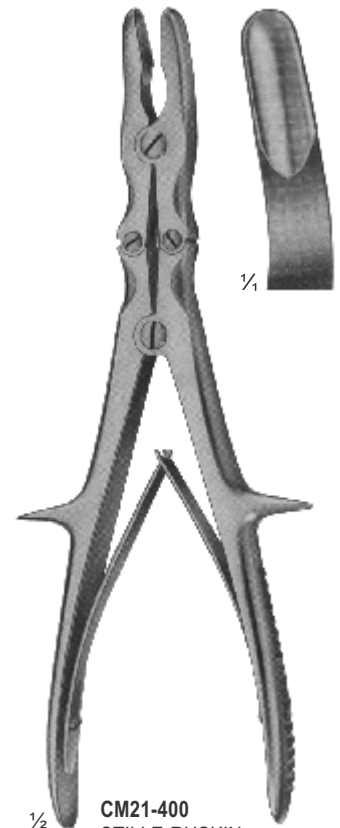

1/2 **CM21-400**
STILLE-RUSKIN
240mm

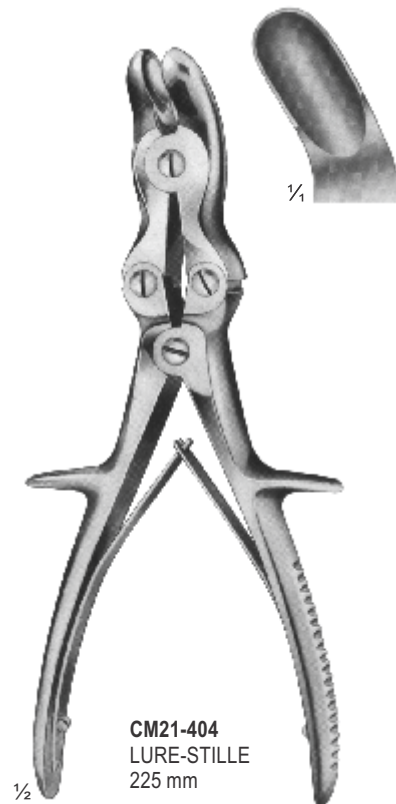
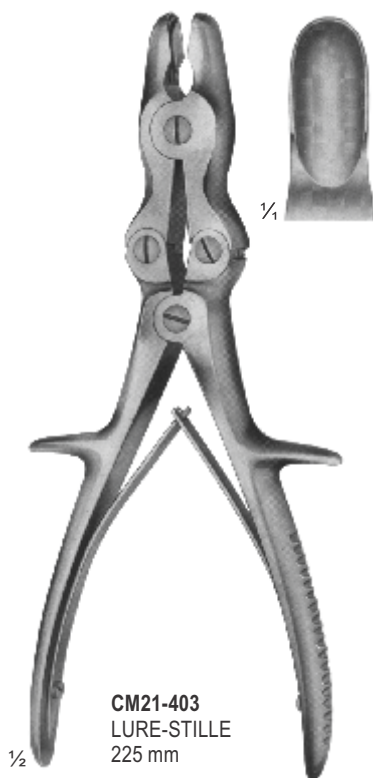
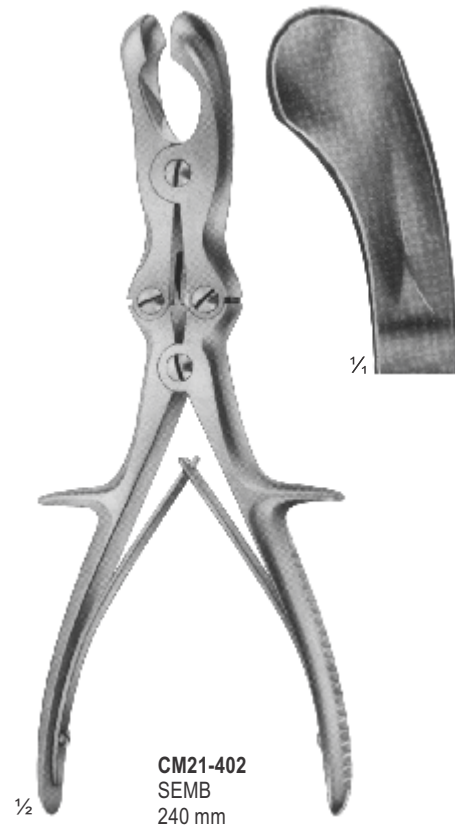
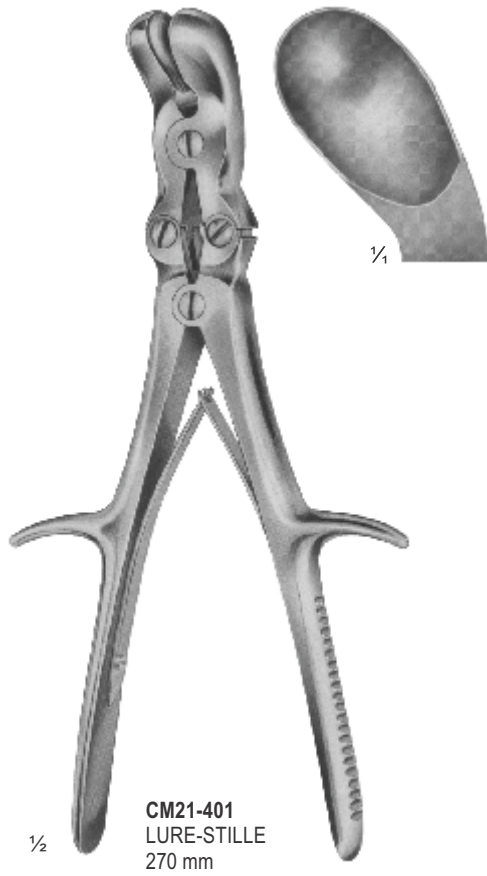

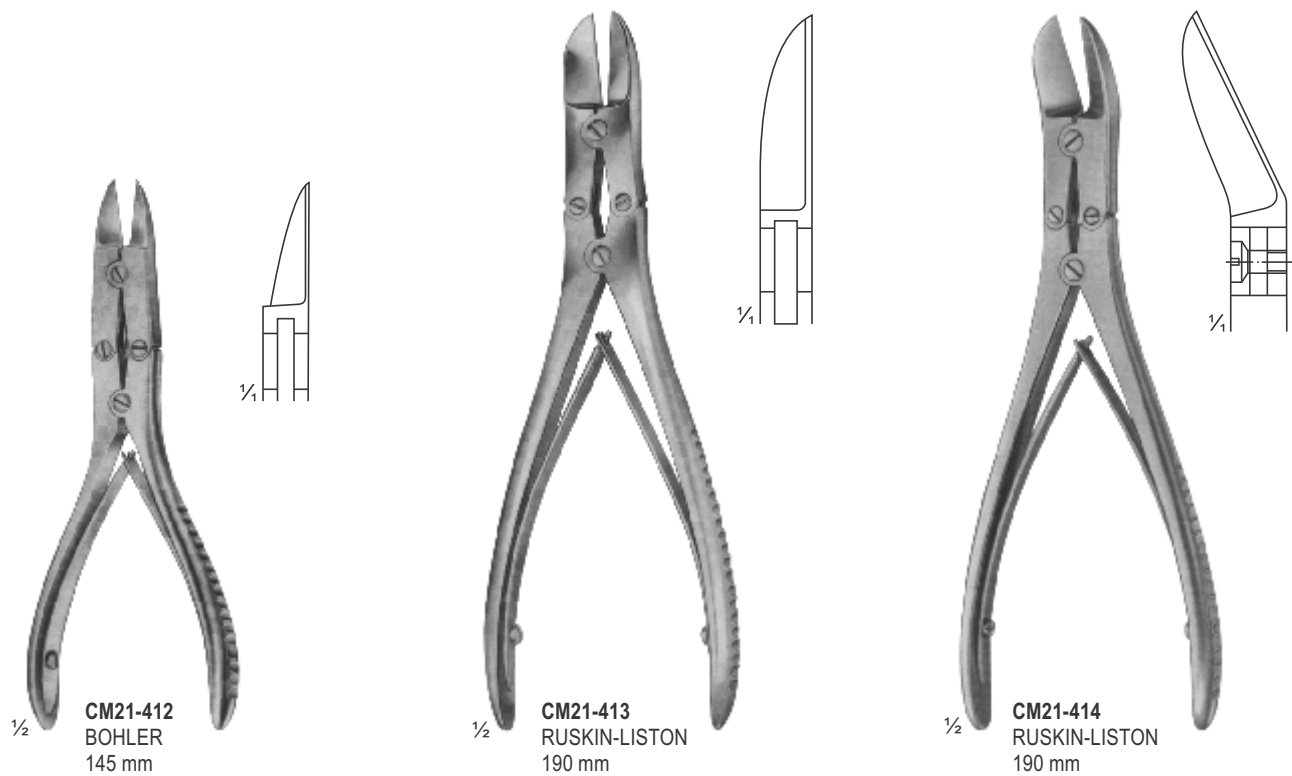
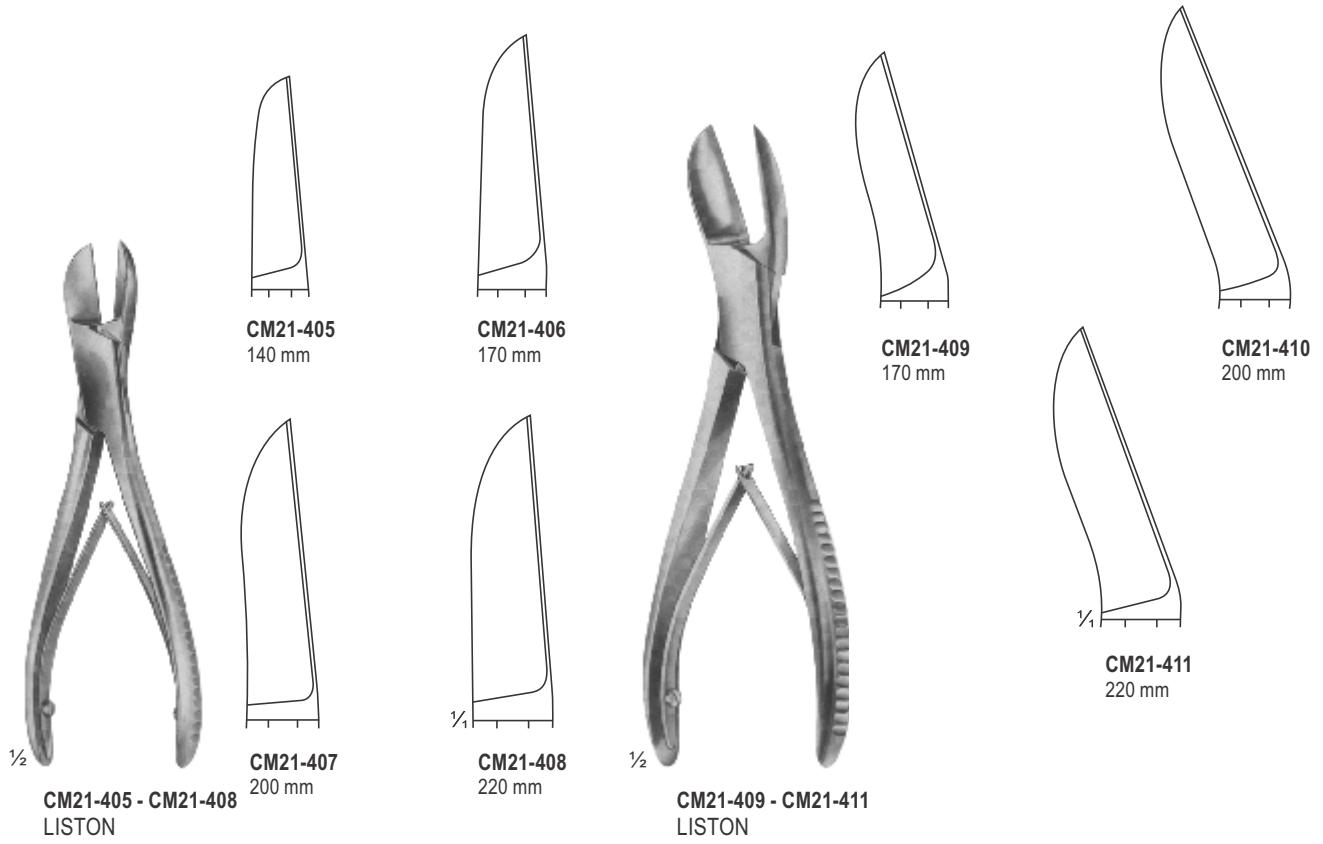

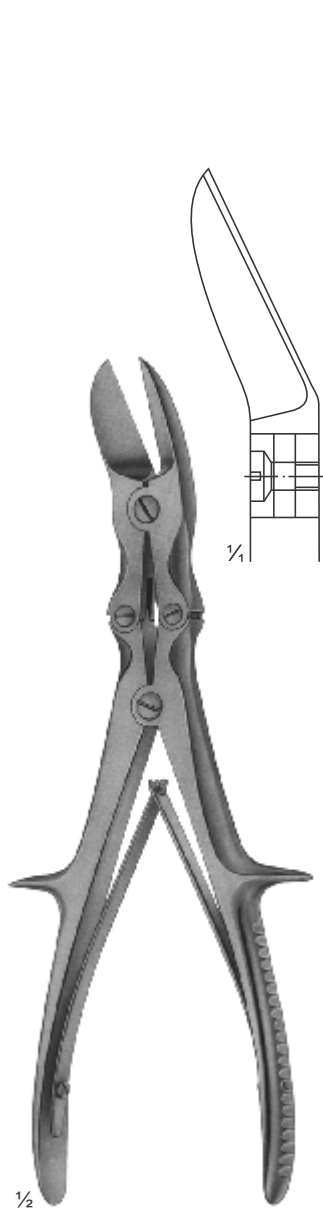

CM21-415
LISTON
curved on flat
240 mm

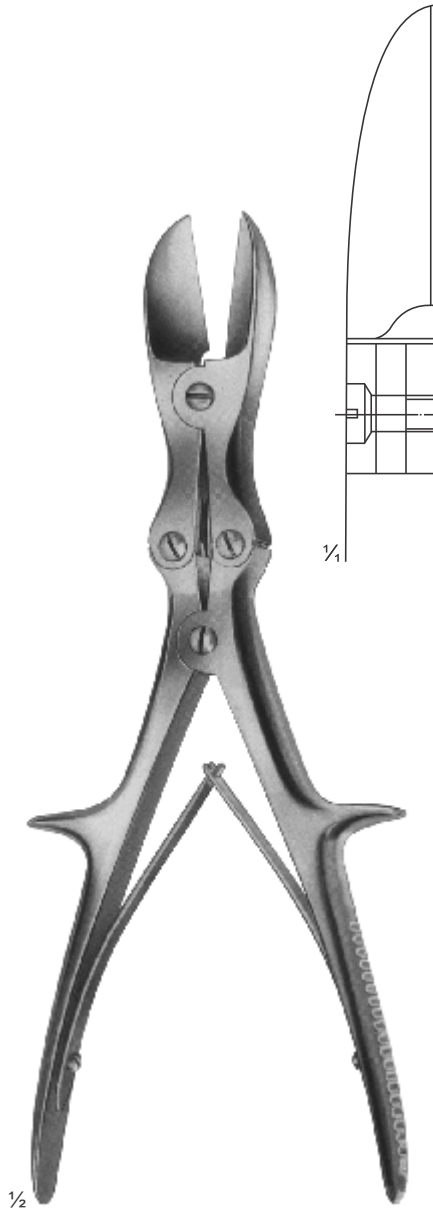

CM21-416
LISTON
straight
280 mm

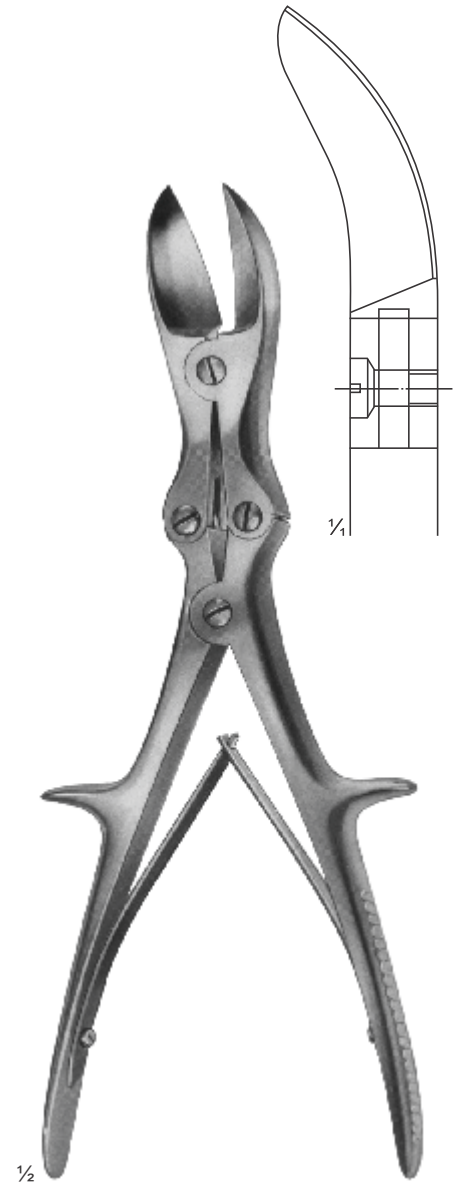

CM21-417
LISTON
curved on flat
280 mm

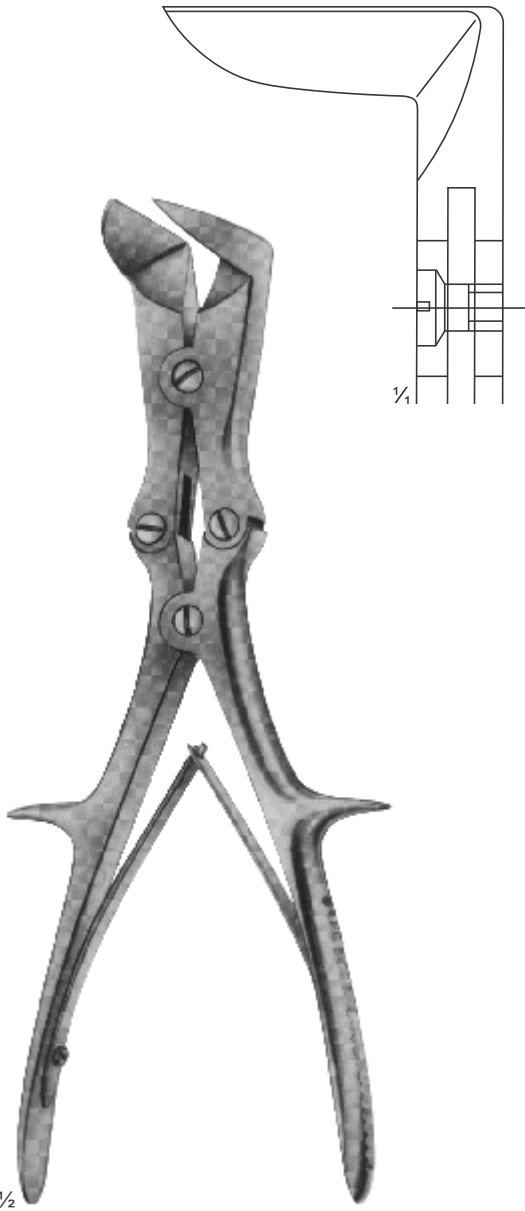

CM21-418
LISTON-STILLE
265 mm

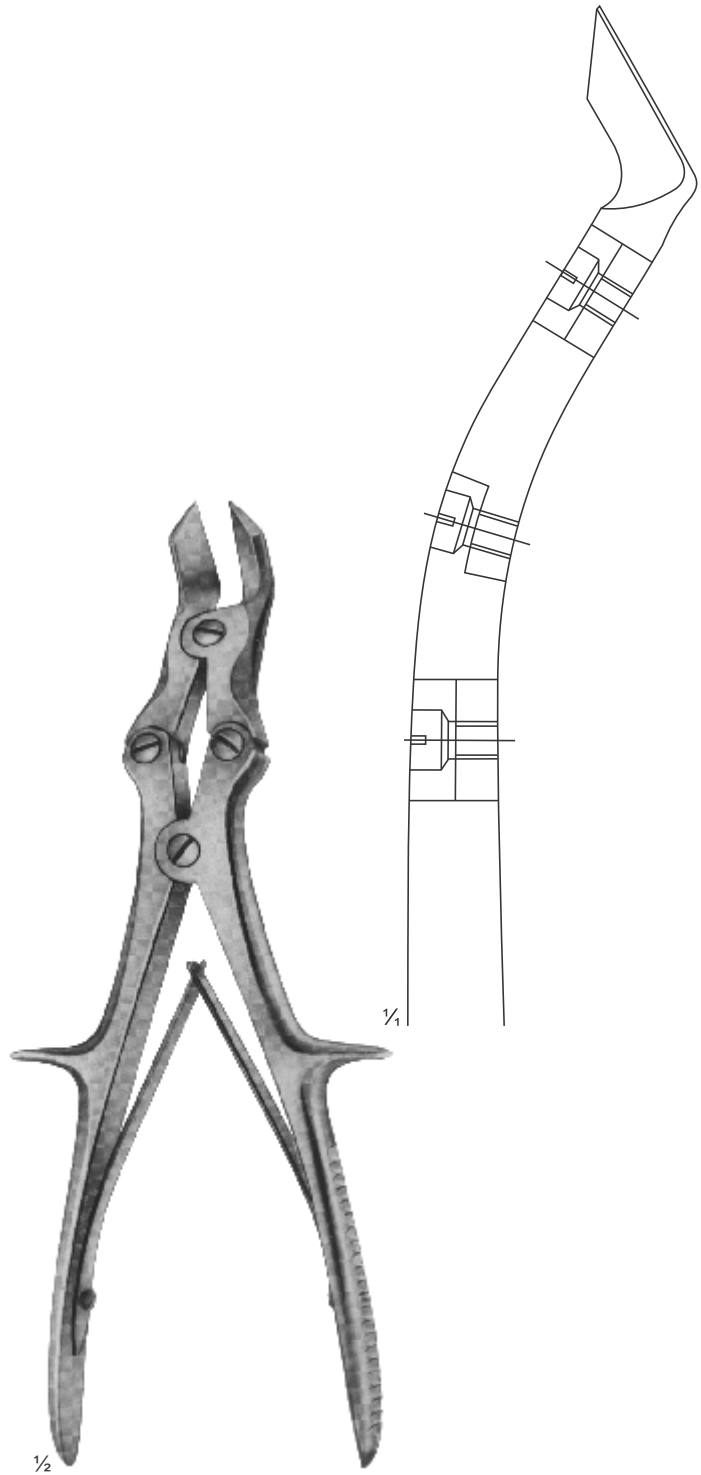

CM21-419
LISTON-KEY-HORSLEY
(TUDOR EDWARDS)
255 mm

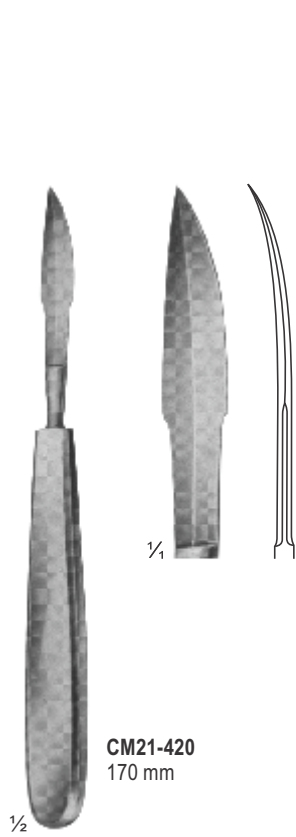

CM21-420
170 mm

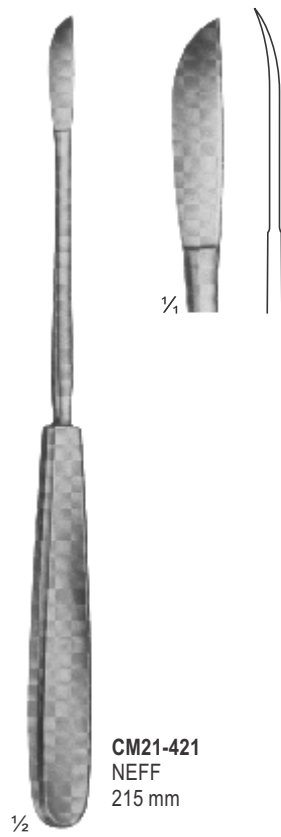

CM21-421
NEFF
215 mm

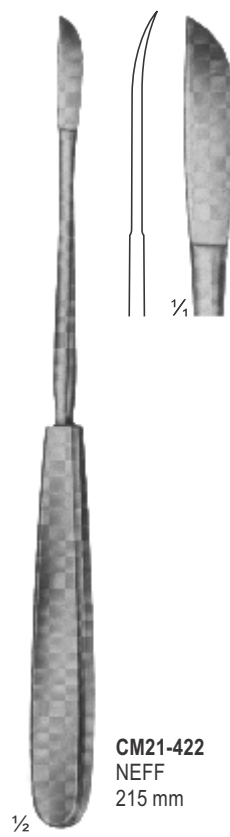

CM21-422
NEFF
215 mm

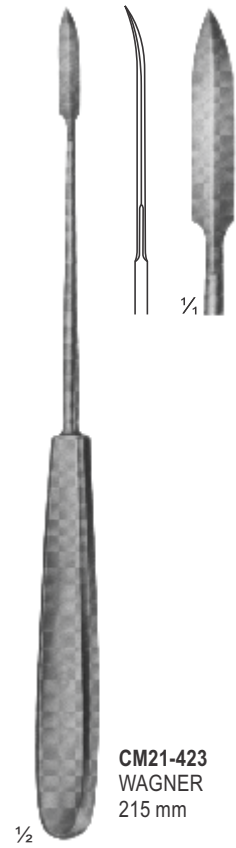

CM21-423
WAGNER
215 mm

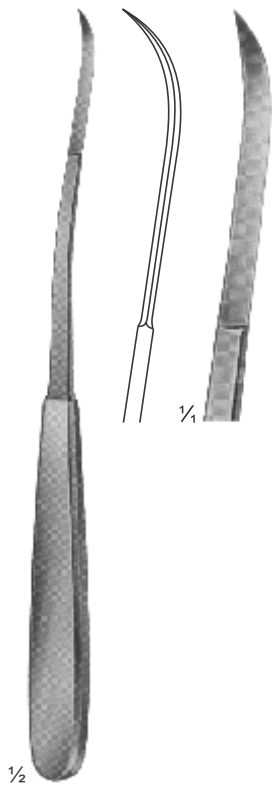

CM21-424
SALENIUS
220 mm

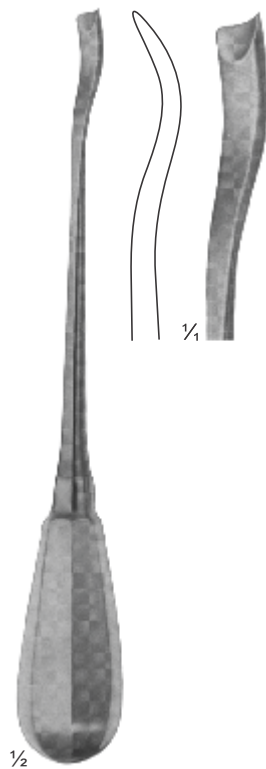

CM21-425
CHNAD.MODELL
200 mm

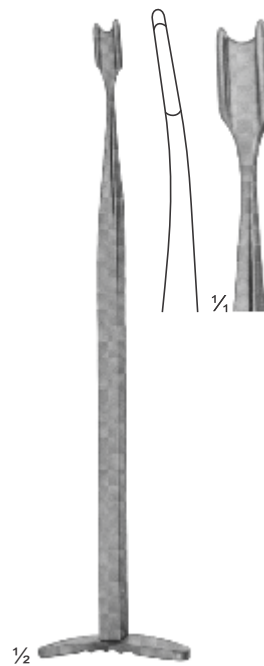

CM21-426
SMILLIE
170 mm

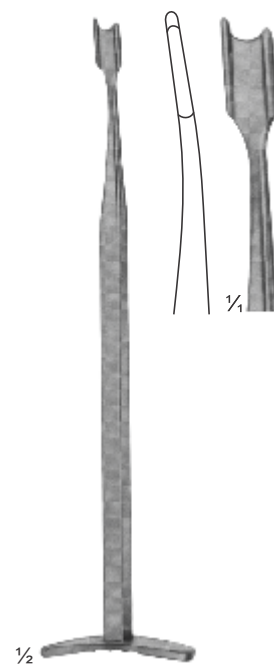

CM21-427
SMILLIE
170 mm

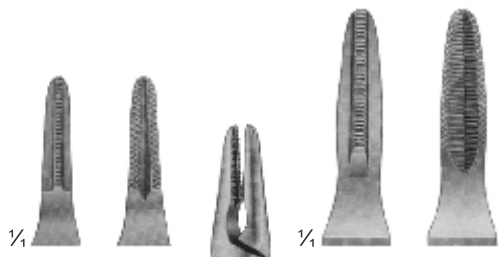

CM21-428
130 mm

CM21-429
180 mm



Extraction pliers
for boring wires
CM21-428 - CM21-429

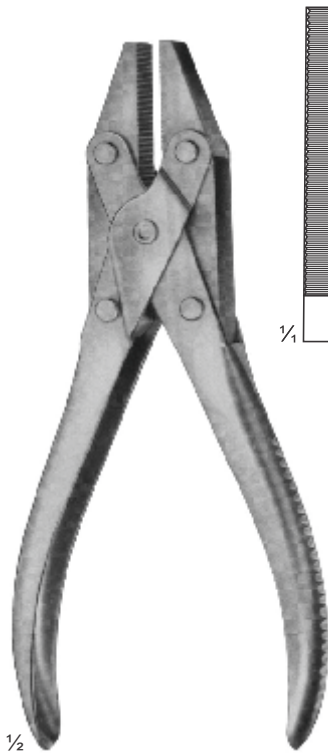

Flat-nosed pliers,
parallel
CM21-430
185 mm

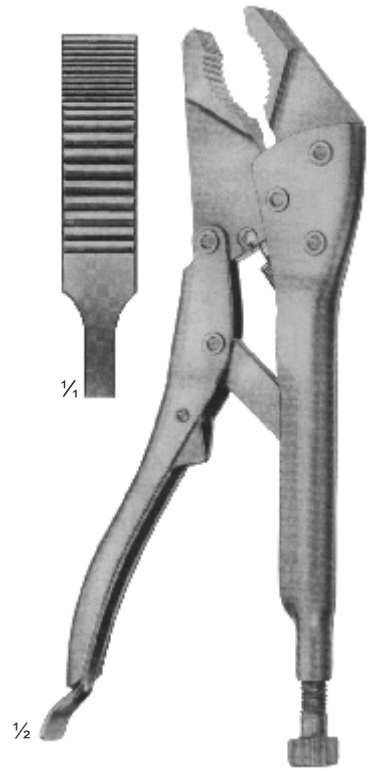
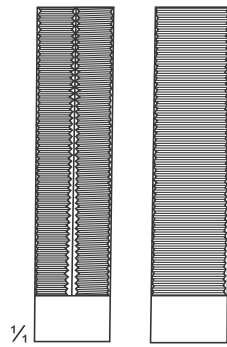

Vise grip
CM21-431
200 mm

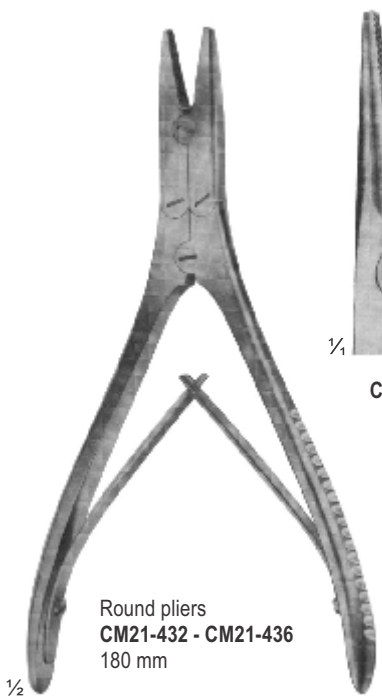

Round pliers
CM21-432 - CM21-436
180 mm

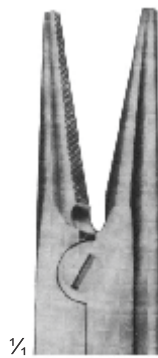

CM21-432



CM21-433



CM21-434



CM21-435



CM21-436

CM21-433
CM21-434 14.5 cm
CM21-435 18 cm
CM21-436 18 cm
Extraction pliers for wires

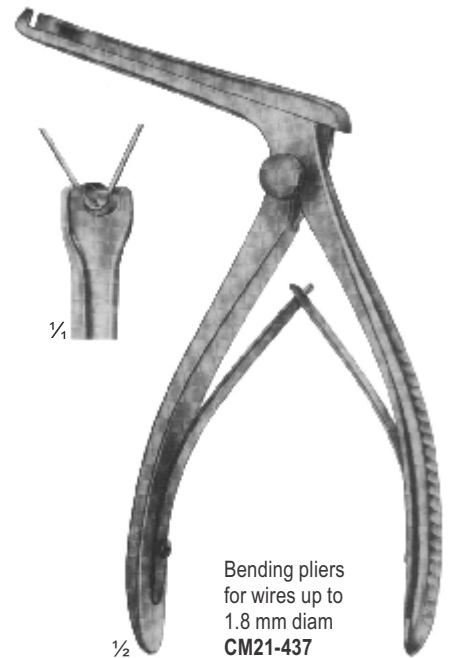

Bending pliers
for wires up to
1.8 mm diam
CM21-437



BOHLER
CM21-438
145 mm

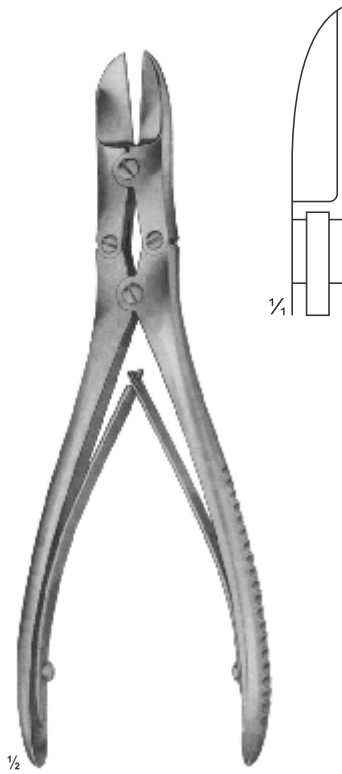

RUSKIN-LISTON
CM21-439
190 mm

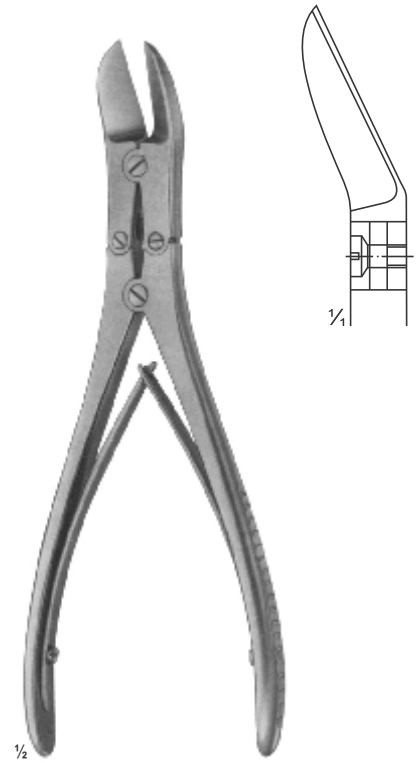

RUSKIN-LISTON
CM21-440
190 mm

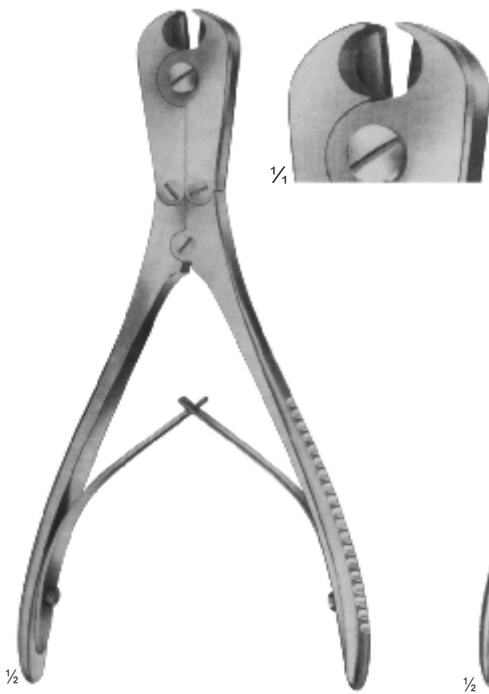

CM21-441
180 mm

for soft wire
up to diam. 2,0 mm
For hard wire 1,5 mm
up to diam
specially hardened
cutting edges, front
and lateral cutting
action



REILL
CM21-442
175 mm

for soft wire
up to diam. 2,0 mm
For hard wire 1,6 mm
up to diam
specially hardened
cutting edges, for
cutting off wires close
to the bone



CM21-443
235 mm

for soft wire
up to diam. 3,0 mm
For hard wire 2,2 mm
up to diam

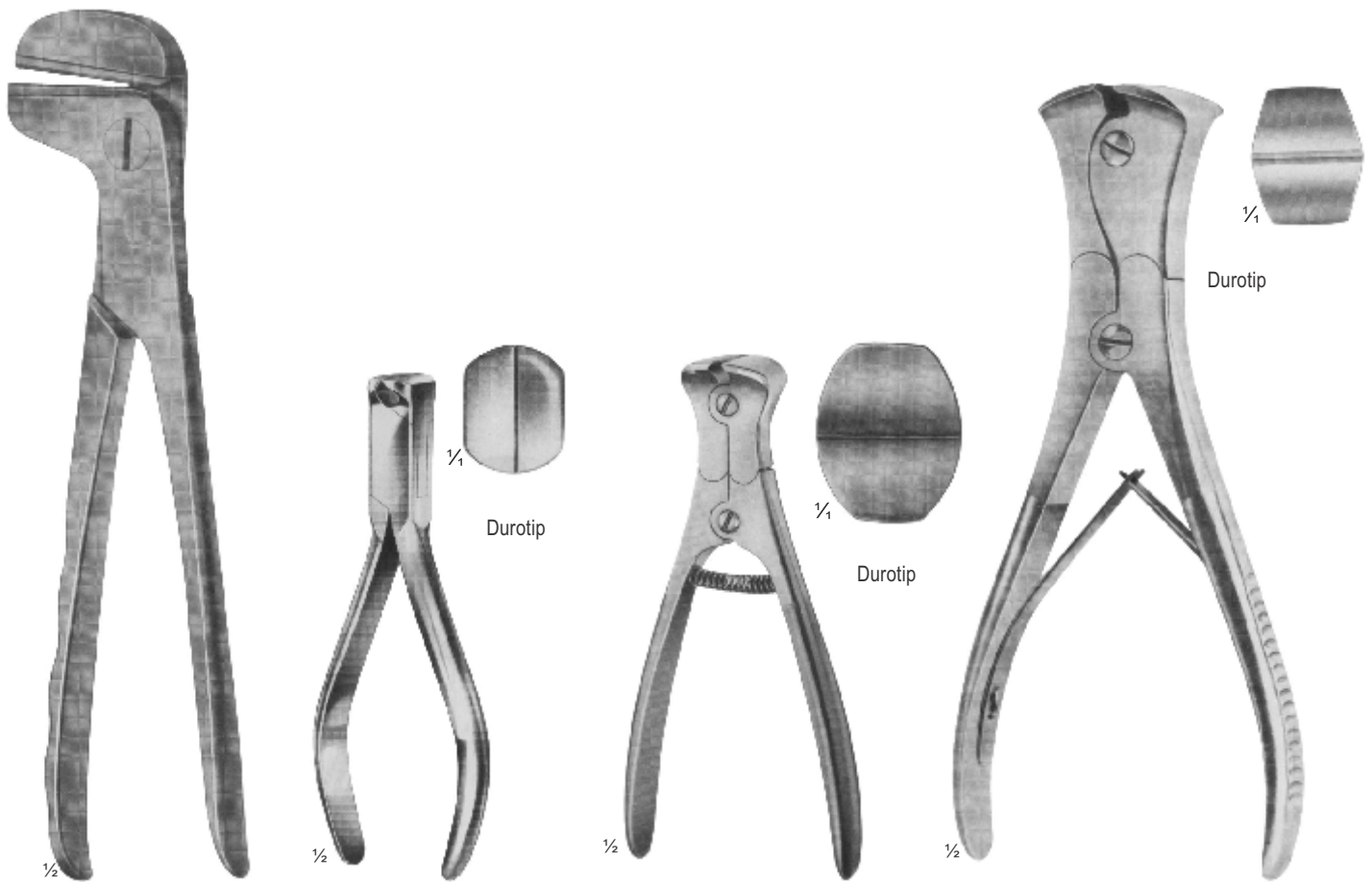

CM21-444
240 mm
for soft wire up to diam. 2 mm
For hard wire up to diam. 1.6 mm

CM21-445
140 mm
for soft wire up to diam. 1.5 mm
For hard wire up to diam. 1 mm

CM21-446
145 mm
for soft wire up to diam. 2 mm
For hard wire up to diam. 1.5 mm

CM21-447
220 mm
for soft wire up to diam. 3.5 mm
For hard wire up to diam. 2.5 mm



CM21-448
320 mm

for soft wire up to diam. 3 mm
For hard wire up to diam 3 mm

Cutter for cutting off
KIRSCHNER wires,
Tibia head screws,
bolts, pins, up to 3 mm diam.

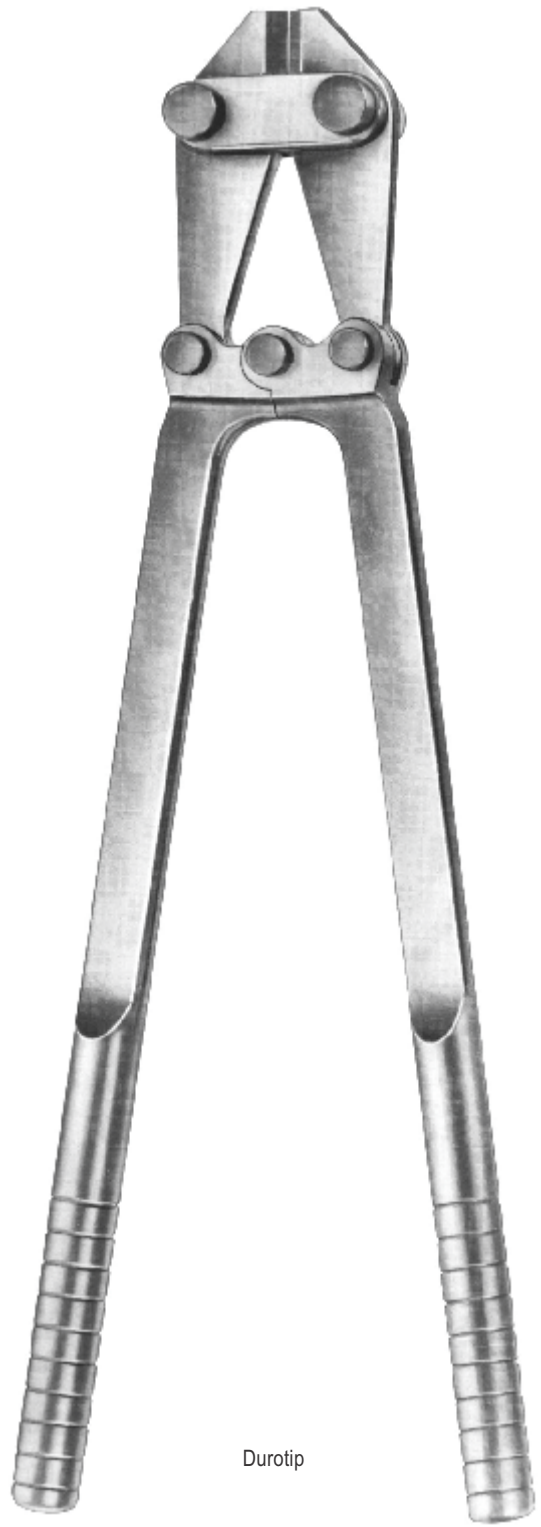

Durotip

CM21-449
Cutter for cutting off
KIRSCHNER wires,
Tibia head screws,
bolts, pins, up to 6 mm diam.
470 mm

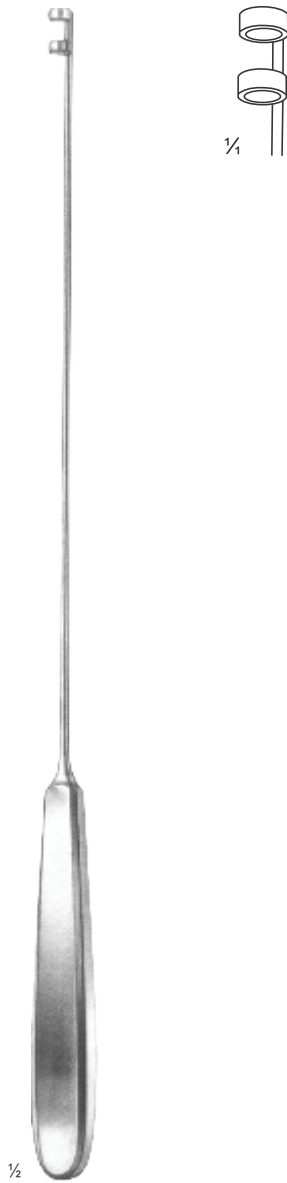

FISCHER
CM21-450
310 mm
Blunt

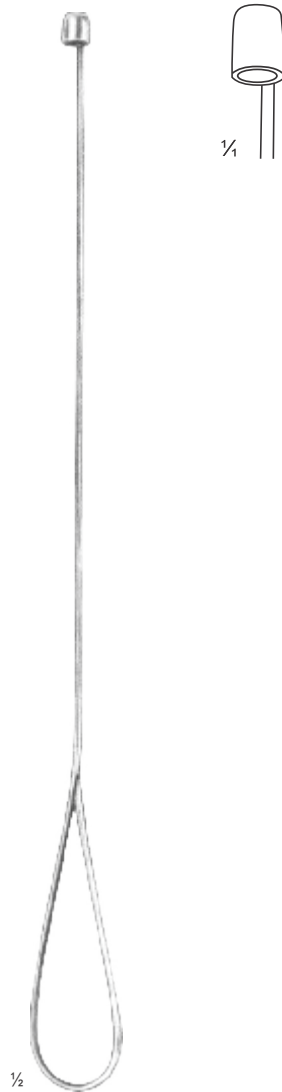

CM21-451
285 mm

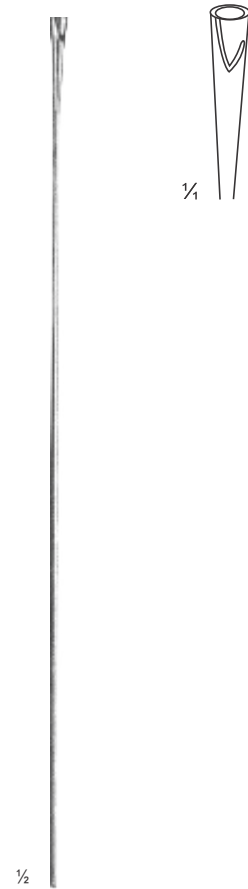

BUNNELL
CM21-452
230 mm
Tendon Passer

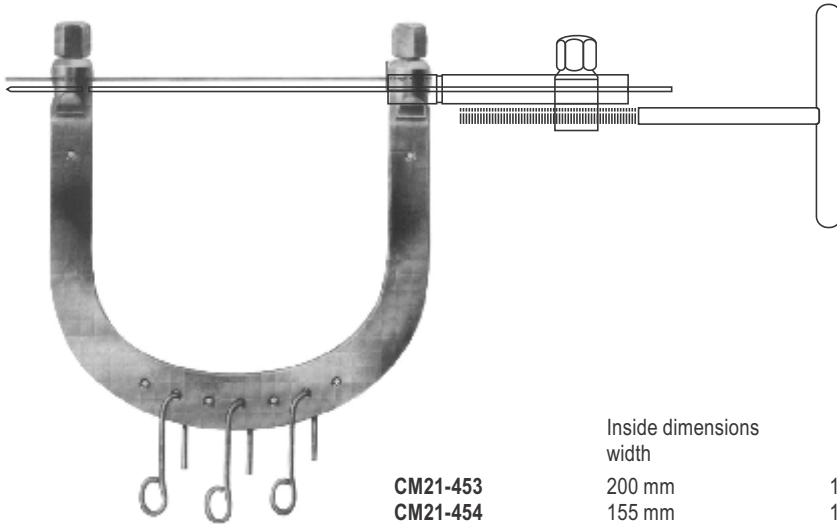

KIRSCHNER
CM21-453 - CM21-459
Wire traction bows,
to be used with
KIRSCHNER-wires
up to 2.5 mm diam.,
With 3 hooks,
stainless steel

	Inside dimensions width	Depth
CM21-453	200 mm	155 mm
CM21-454	155 mm	155 mm
CM21-455	135 mm	130 mm
CM21-456	120 mm	120 mm
CM21-457	105 mm	100 mm
CM21-458	95 mm	110 mm
CM21-459	95 mm	70 mm



CM21-460
Wrench, double - ended,
for wire traction bows

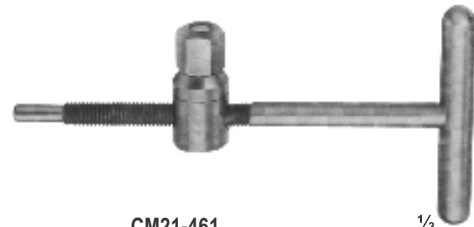

CM21-461
Wire tightener, with
clamping jaws



1/3

CM21-462
Traction hook only,
large size



1/3

CM21-463
Traction hook only,
small size



1/3

CM21-464
Fixation clamp, to secure clamping
jaws of stainless steel

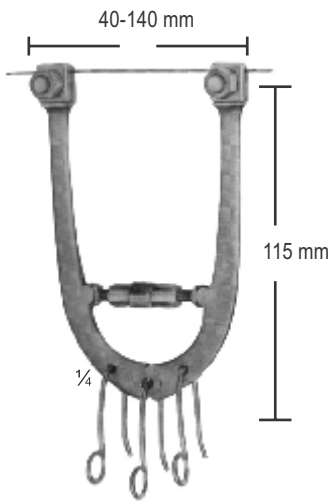

CM21-465
Wire traction bow, adjustable,
with 3 hooks, small size

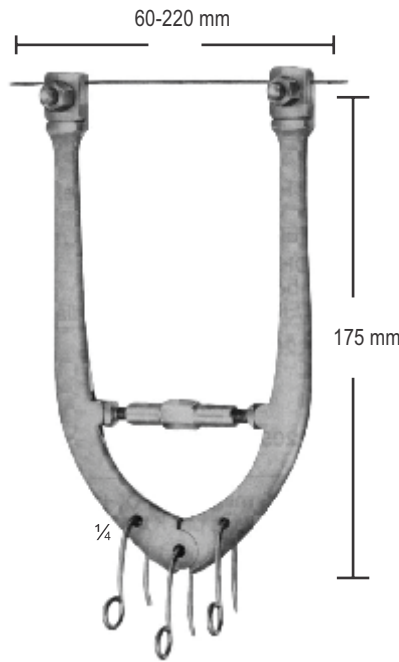

CM21-466
Wire traction bow, adjustable,
with 3 hooks, large size

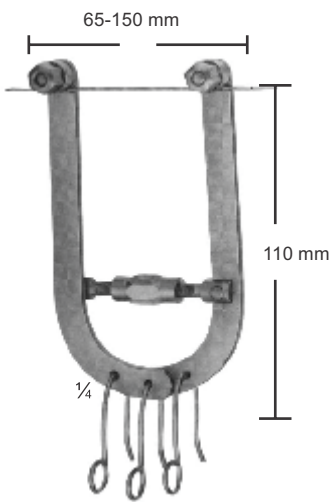

CM21-467
Wire traction bow, adjustable,
with 3 hooks, large size for
elbow and calcaneus, for
adolescents



CM21-470 10 cm
CM21-471 16 cm
CM21-472 20 cm

CM21-473 1.6 mm
CM21-474 2 mm
CM21-475 2.5 mm

KIRSCHNER
CM21-470 - CM21-475
Wire traction bow, modified
adjustable in width, holds wire
securely, with 1 hook



CM21-468 1/2
Fixation disc, slotted



CM21-469 1/2
idem, aluminum, transparent
to X-rays



CM21-476 1/2
Fixation disc, slotted



CM21-477 1/2
Screw driver, for above
fixations discs

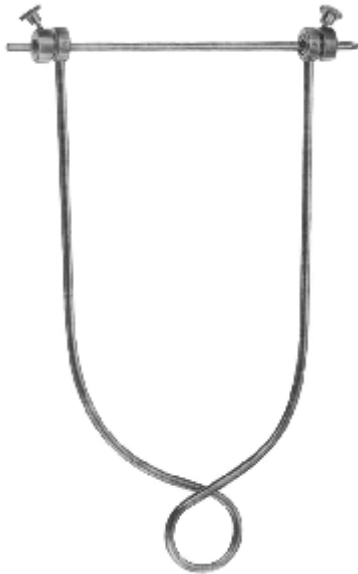

CM21-478 - CM21-485
Screw driver, for above
fixations discs

Steinmann pins, 4 mm daim.	Steinmann pins, 5 mm daim.
CM21-478 with pin	16x9cm Arm
CM21-479 without pin	CM21-480-00 without
CM21-481 with pin	21x11cm Arm
CM21-482 without pin	CM21-483 without
CM21-484 with pin	21x15cm Arm
CM21-485 without pin	



CM21-486
SCHWARZ
Traction bow for fingers,
to be used with KIRSCHNER-
wire up to 1.6 mm diam.

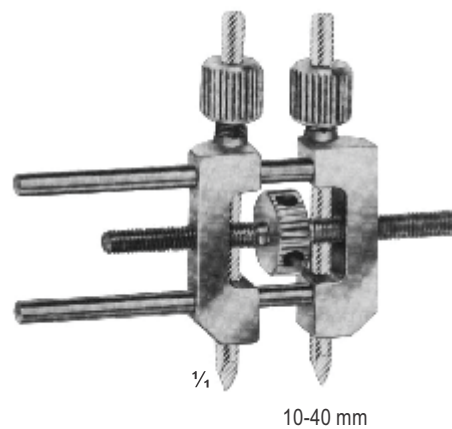

CM21-487
Small distractor
as a repositioning device for
distraction and compression of small bones,
for wires with 3 mm diam.



STEINMANN
CM21-488 - CM21-500
 triangular shaft ended
 and trocar point

Length	4 mm	5 mm
80 mm	CM21-488	
100 mm	CM21-489	
120 mm	CM21-490	
140 mm	CM21-491	
150 mm	CM21-492	CM21-493
160 mm	CM21-494	
180 mm	CM21-495	CM21-496
200 mm	CM21-497	CM21-498
210 mm	CM21-499	
250 mm	CM21-500	CM21-501
300 mm		CM21-502



¼

CM21-503
 Protection cap
 for 4 mm STEINMANN Pins



¼

CM21-504
 Protection cap
 for 5 mm STEINMANN Pins



REILL
CM21-505
Drilling chuck,
cannulated,
for shanks from
2.0 - 2.5 mm diam
115 mm



CM21-506
Drilling chuck,
cannulated,
for shanks from
0.8 - 2.0 mm diam
150 mm



CM21-507
Drilling chuck,
cannulated,
for shanks up to
4.5 mm diam
with key
140 mm



LOUTE
CM21-508
Wire tightener, improved pattern,
with movable tip,
for wires up to 1.0 mm diam.
220 mm

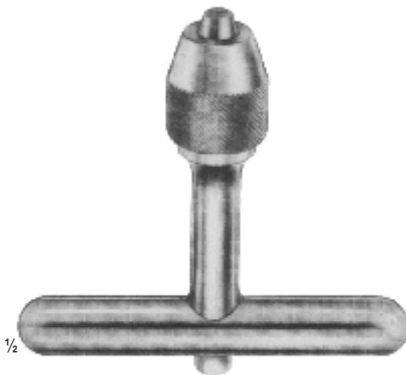

CM21-509
Drilling chuck, cannulated,
for shanks up to 6.35 mm diam.,
To be tightened by hand
100 mm



CM21-510
Drilling chuck, cannulated,
for shanks up to 4.5 mm diam.,
And for triangular shaft width
across flats 4.7 mm

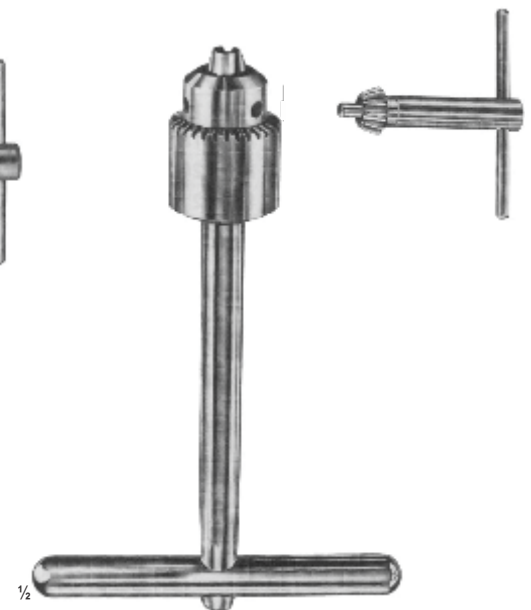

CM21-511
Drilling chuck, cannulated,
for shanks up to 6.35 mm diam.,
With key
160 mm

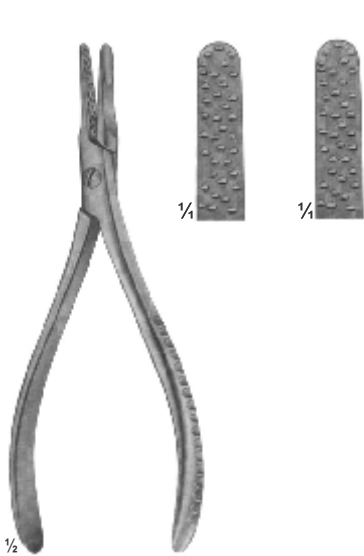

CM21-512
Nail extracting
forceps
135 mm

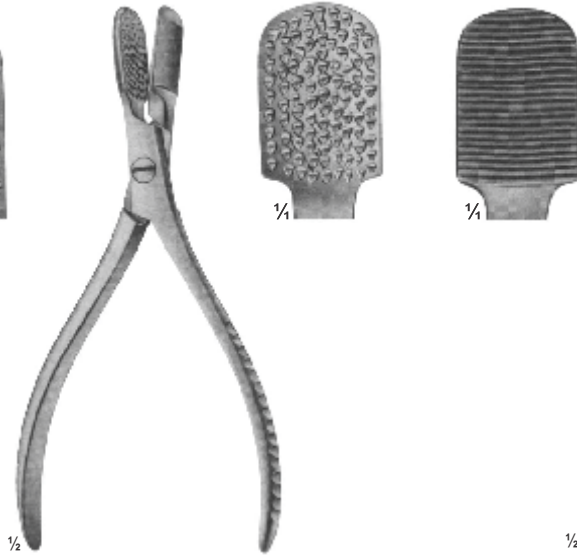

CM21-513
Nail extracting
forceps
145 mm

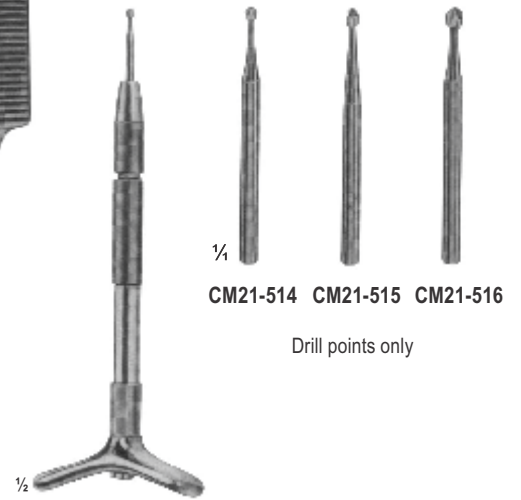

MARTIN-IDEAL
CM21-514 - CM21-516
Finger nail drill
with 3 points

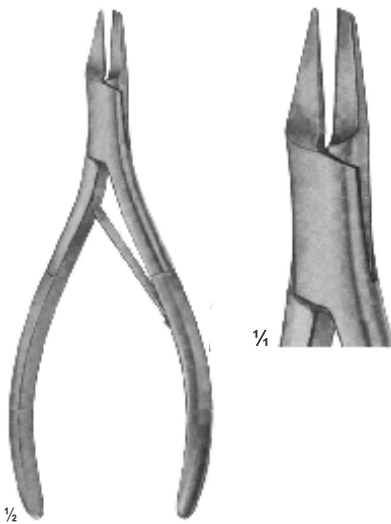

CM21-517
Nail splitting
forceps
135 mm

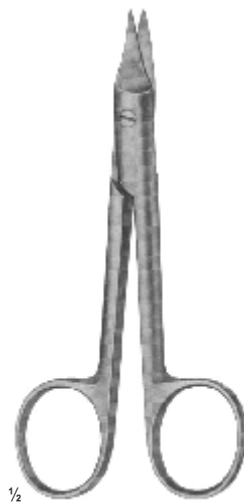

SYSTRUNK
CM21-518
Scissors, for splitting
finger nails
130 mm

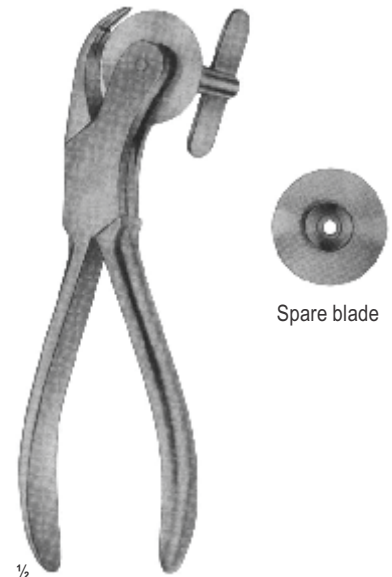

CM21-519
Finger ring saw
150 mm

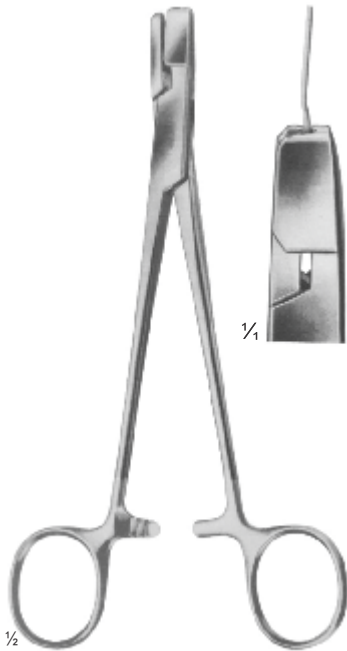

**DUROGRIP
CM21-520**
Holding forceps for cerclage
wire, with lateral jaws to avoid
wire slipping off
170 mm



**DUROGRIP
CM21-521**
Wire, tightening pliers,
Ligature pliers
150 mm



**DUROGRIP
CM21-522**
Wire, tightening pliers,
Ligature pliers
150 mm

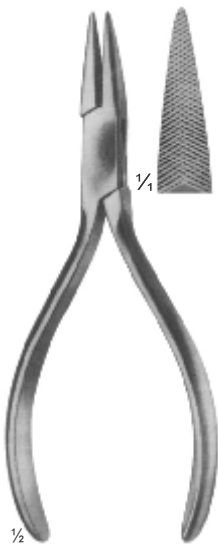

CM21-523
with serrated jaws
140 mm

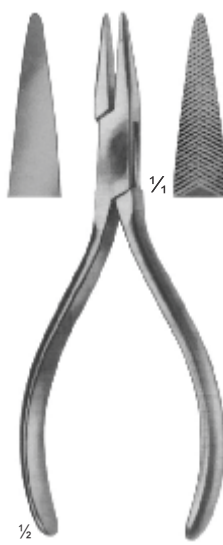

CM21-524
one jaws smooth,
one jaws serrated
140 mm



CM21-525
with serrated jaws
CM21-526
with longitudinal and
transversal grooves
170 mm

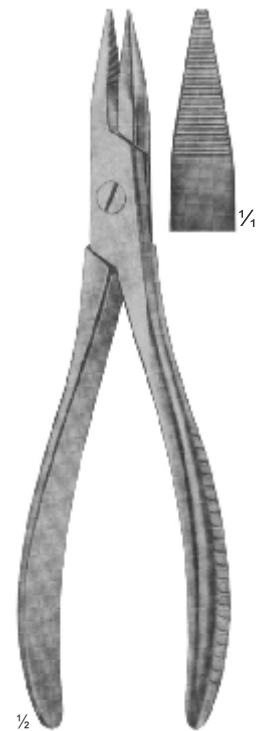

CM21-527
190 mm

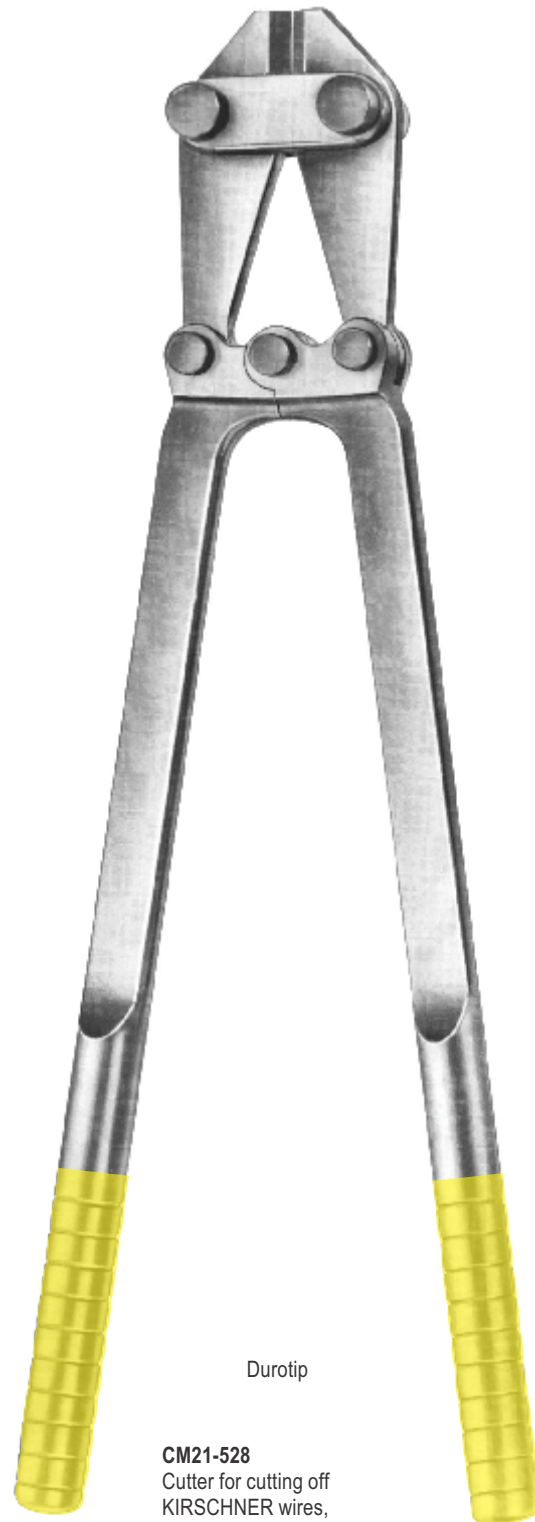

Durotip

CM21-528
Cutter for cutting off
KIRSCHNER wires,
Tibia head screws,
bolts, pins, up to 6 mm diam.
47 cm



CM21-529
For Soft Wire \varnothing cm 3.5
For Hars Wire \varnothing cm 2.5
22 cm



CM21-530
For Soft Wire \varnothing cm 2.0
For Hars Wire \varnothing cm 1.5
22 cm



CM21-531
For Soft Wire \varnothing cm 2.0
For Hars Wire \varnothing cm 1.6
18 cm



CM21-532
17 cm



CARE MEDICAL[®]
SUPPLIES

Your health _ Our Priority

Section

22

Page 461-467

Plaster Instruments
Plaster Scissors
Scalpels, Tenotomes
Plaster Shears
Plaster Spreader, Plaster Breakers



HOPKINS
CM-22-001
20 cm



ESMARCH
CM22-002
18 cm



ENGEL
CM-22-003
16 cm



UNIVERSAL
CM22-004 - CM22-012

- | | | | |
|----------|-------|----------|-------------|
| CM22-004 | black | CM22-008 | yellow |
| CM22-005 | red | CM22-009 | white |
| CM22-006 | blue | CM22-010 | orange |
| CM22-007 | green | CM22-011 | lavender |
| | | CM22-012 | bright pink |



UNIVERSAL
CM22-113-00 - CM22-121-00

- | | | | |
|----------|-------|----------|-------------|
| CM22-013 | black | CM22-017 | yellow |
| CM22-014 | red | CM22-018 | white |
| CM22-015 | blue | CM22-019 | orange |
| CM22-016 | green | CM22-020 | lavender |
| | | CM22-021 | bright pink |

For small plaster dressings



1/2

CM22-122
16 cm

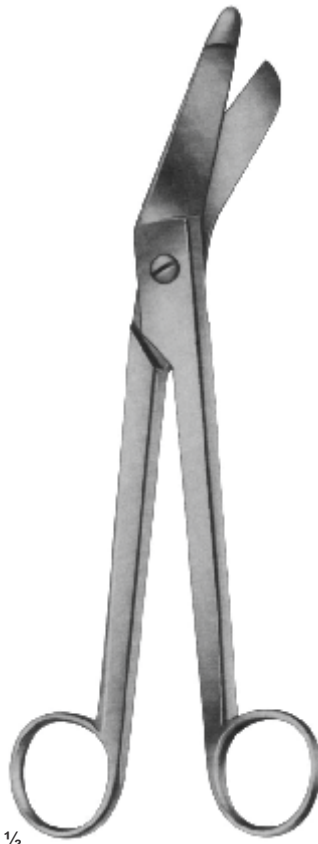

1/2

ESMARCH
CM22-023 - CM22-024
CM22-023 20 cm
CM22-024 23 cm



1/2

BERGMANN
CM22-025
23 cm



1/2

BRUNS
CM22-026
23.5 cm



1/2

BRUNS
CM22-027
23.5 cm

also to be used as
bandage scissors



1/2

SEUTIN
Cm22-028
23 cm

also to be used as
bandage scissors

TC GOLG

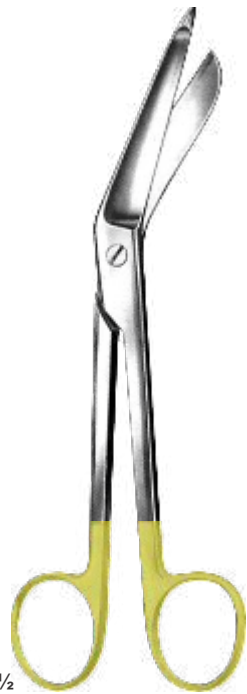

1/2

LISTER
CM22-029
23.5 cm

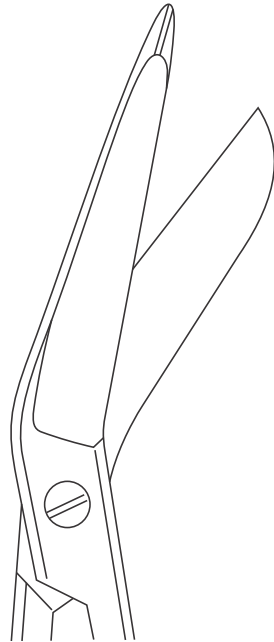

1/2

BRUNS
CM22-030
23.5 cm

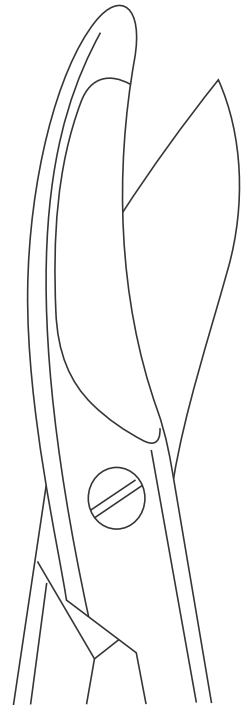



STILLE
CM22-031
26 cm



STILLE
CM22-032
36 cm

Blade with reinforced back



STILLE
CM22-033
23 cm

CM22-034
Spare blade

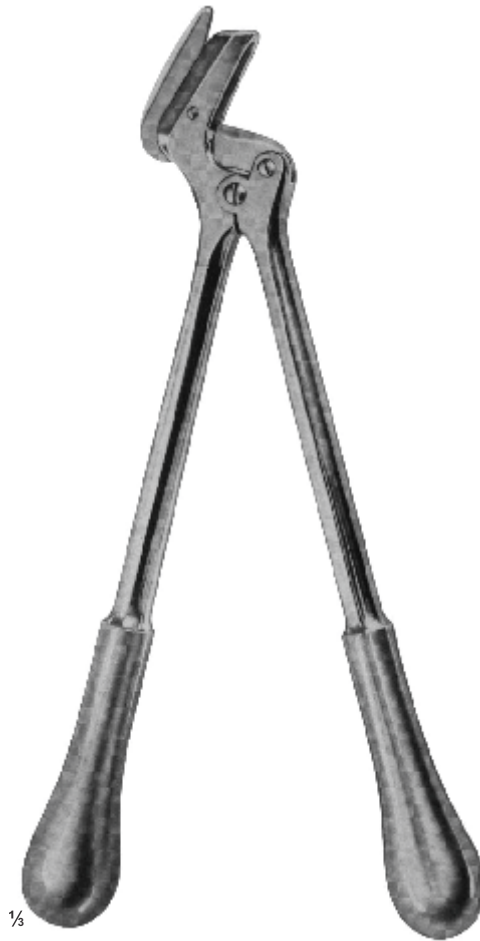

STILLE
CM22-035
37 cm

CM22-036
Spare blade



STILLE
CM22-037
24 cm

CM22-038
Spare blade



HENING
CM22-039
27 cm



MOD. USA
CM22-040
23 cm



CM22-041
29 cm



with removable jaws



WOLFF
CM22-042 - CM22-043
CM22-042 18 cm
CM22-043 24 cm



CARE MEDICAL[®]
SUPPLIES

Your health _ Our Priority

Section

23

Page 468-496

Nerve - And Vessel Hooks
Dura Hooks
Dura Dissectors
Nerve Root Retractors
Brain Retractors
Retractors For Cervical Vertebral Column
Skull Instruments
Leyla Fixation System (yasargil)



WAGENER
CM23-001 - 004
150 mm



1/4
CM23-001



1/4
CM23-002



1/4
CM23-003



1/4
CM23-004



GRAEFE
CM23-005 - 007
140 mm



1/4
CM23-005



1/4
CM23-006



1/4
CM23-007



BROM
CM23-008
Vein hook
170 mm



1/4



CRILE
CM23-009
200 mm



1/4



CUSHING
CM23-010- 011
190 mm



1/4
CM23-010



1/4
CM23-011

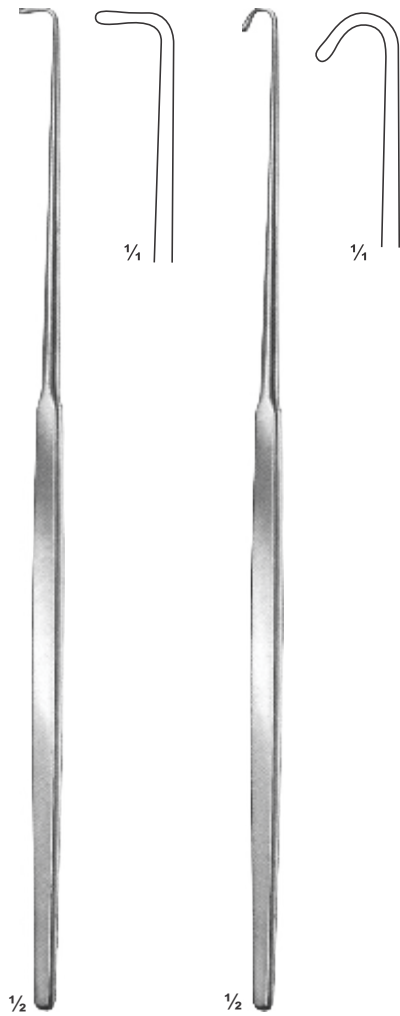

GRONINGEN
CM23-012
265 mm

GRONINGEN
CM23-013
265 mm

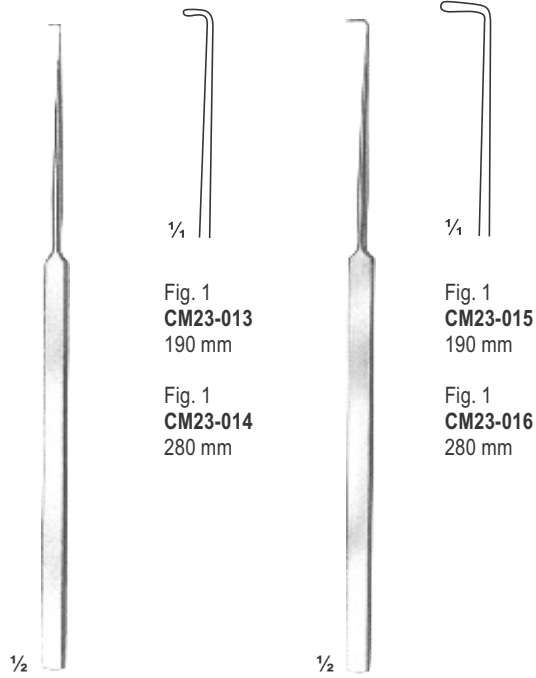

Fig. 1
CM23-013
190 mm

Fig. 1
CM23-014
280 mm

Fig. 1
CM23-015
190 mm

Fig. 1
CM23-016
280 mm



CM23-017
165 mm



CM23-018
210 mm



SMITHWICK
CM23-017 - CM23-018



1/2

KRAYENBUHI
CM23-019 - 022
190 mm



1/4

Fig.1
CM23-019



1/4

Fig.2
CM23-020



1/4

Fig.1
CM23-021



1/4

Fig.2
CM23-022



1/2

CASPER
CM23-023 - 026
245 mm



CM23-023



CM23-024



CM23-025



CM23-026

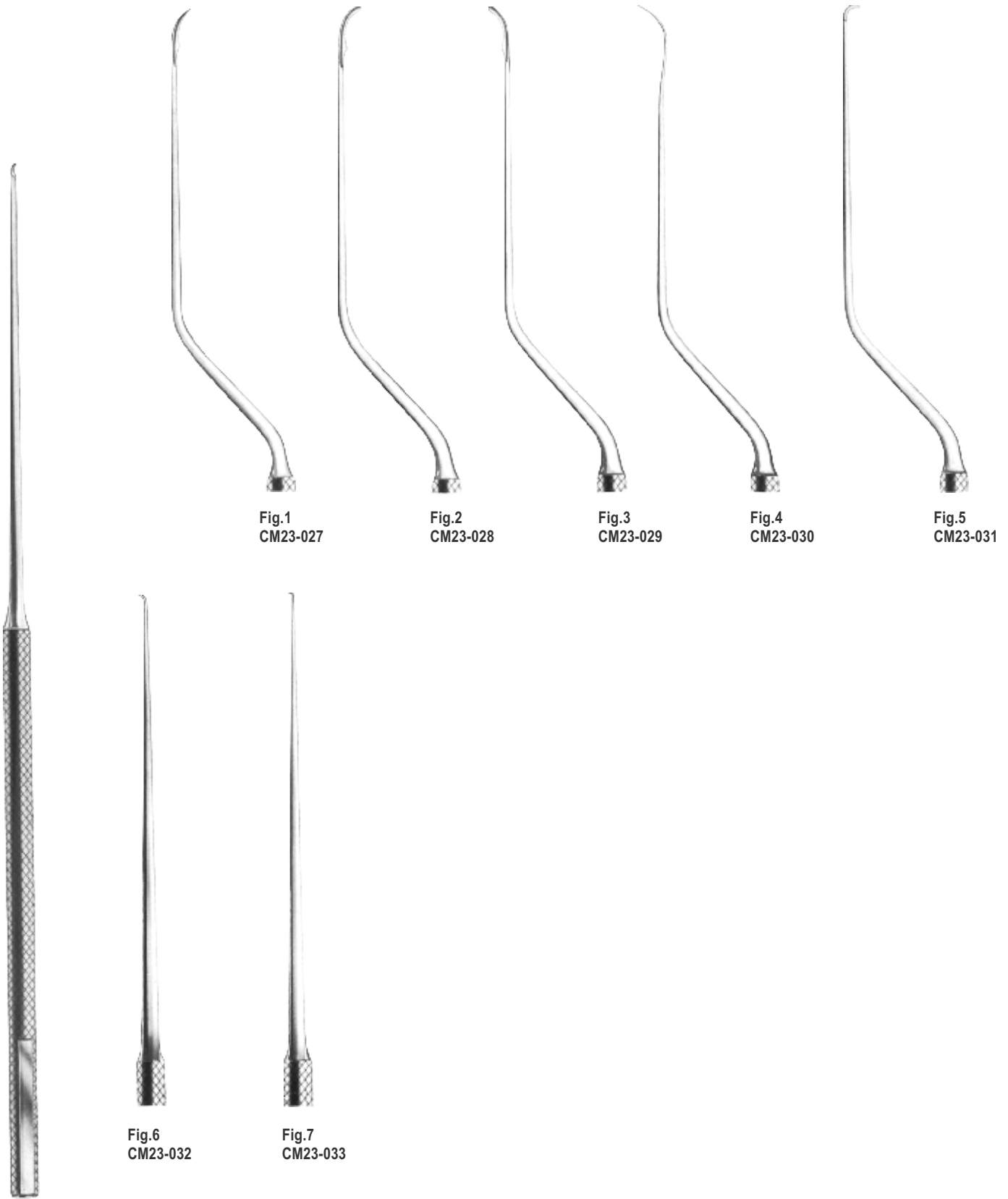

Fig.1
CM23-027

Fig.2
CM23-028

Fig.3
CM23-029

Fig.4
CM23-030

Fig.5
CM23-031

Fig.6
CM23-032

Fig.7
CM23-033

CM23-027 - 033



YASARGIL
CM23-034
190 mm



YASARGIL
CM23-035
190 mm



YASARGIL
CM23-036
190 mm



YASARGIL
CM23-037
190 mm



YASARGIL
CM23-038
190 mm



YASARGIL
CM23-039
190 mm



JACOBSON
CM23-040
190 mm

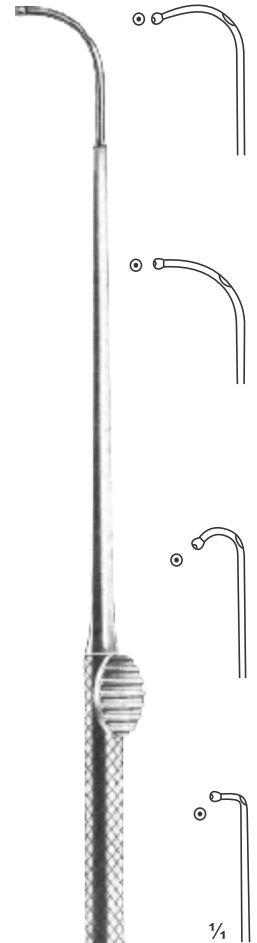

1/4
YASARGIL
CM23-047
190 mm



JACOBSON
CM23-041
190 mm



YASARGIL
CM23-042
190 mm



CM23-043
190 mm



CM23-044
190 mm

YASARGIL



CM23-045
190 mm

CM23-046
190 mm



YASARGIL
CM23-048 - 049
Galea Hook

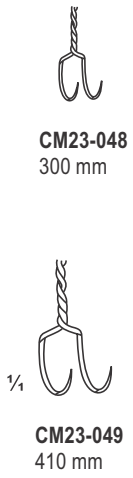

CM23-048
300 mm

CM23-049
410 mm



TOENNIS
CM23-050
240 mm



OLIVECRONA
CM23-051
240 mm





HESS
Nerve Root Retractor
CM23-052 - 054
CM23-052 175 mm 3 mm
CM23-053 175 mm 5 mm
CM23-054 175 mm 7 mm



LOVE
Nerve Root Retractor
CM23-055 - 057
CM23-055 190 mm 30°
CM23-056 190 mm 45°
CM23-057 190 mm 90°



CASPAR
Nerve Root Retractor
CM23-058 - 060
CM23-058 245 mm 6 mm
CM23-059 245 mm 8 mm
CM23-060 245 mm 10 mm



LOVE
CM23-061
210 mm



SCOVILLE
CM23-062
235 mm

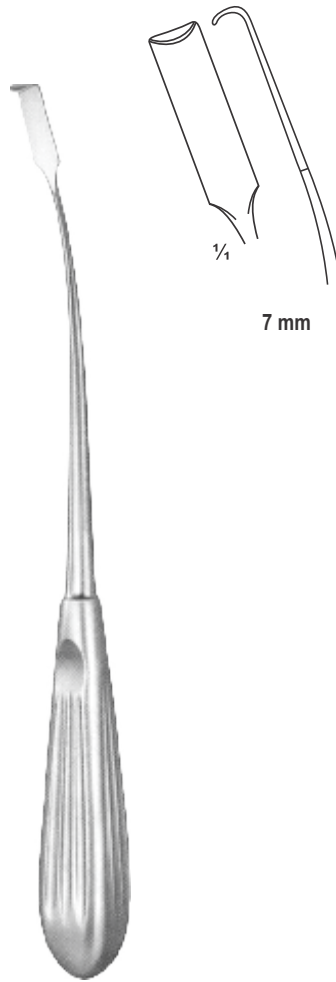

HOLSHER
CM23-063
240 mm

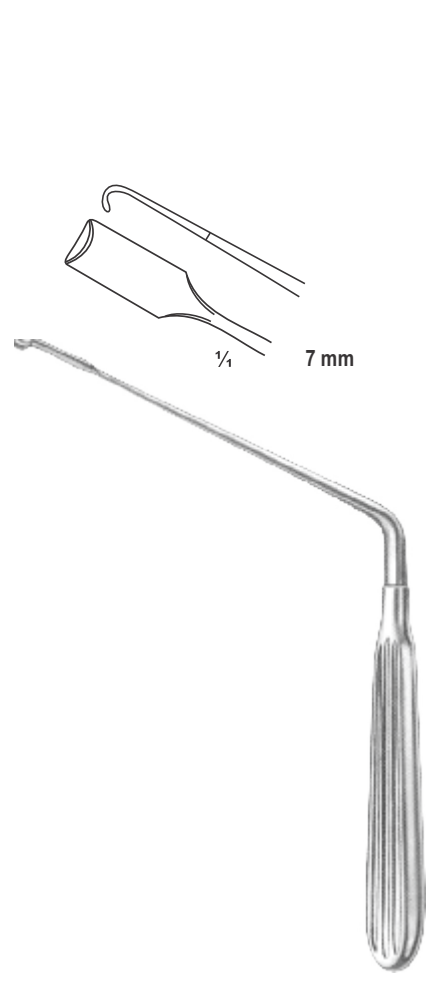

SCOVILLE
CM23-064
165 mm



LEYLA
CM23-065
Self-Retaining brain retractor
with 2 arms complete

LEYLA BED RETRACTOR
CM23-066
Self-Retaining brain retractor
bed retractor not illustrated



OLIVECRONA
CM23-067 - 070
 180 mm
 Concave

CM23-067 7 + 9 mm
CM23-068 11 + 13 mm
CM23-069 15 + 18 mm
CM23-070 18 + 22 mm

1/2



CM23-071
 15.5 cm
 11 mm

CM23-072
 20 cm
 14 mm

CM23-073
 20 cm
 17 mm

CM23-074
 20 cm
 20 mm

1/2

HEIFETZ
CM23-071 - 074



OLIVECRONA
CM23-075 - 078
 180 mm
 Convex

CM23-075 7 + 9 mm
CM23-076 11 + 13 mm
CM23-077 15 + 18 mm
CM23-078 18 + 22 mm

1/2



CM23-079
 8 mm

CM23-080
 14 mm

CM23-081
 17 mm

1/2

HEIFETZ
CM23-079 - 081
 155 mm



CASPAR
CM23-082
Transverse Retractor hinged
65 mm regular spread
110 mm wide spread



CASPAR
CM23-083
Transverse Retractor double-hinged
65 mm spread



CASPAR
CM23-084
Longitudinal Retractor
double-hinged, ring handle
205 mm
85 mm spread

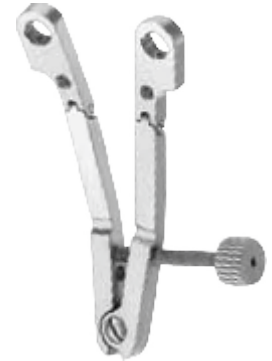

CASPAR
CM23-085
Specula Retractor single-hinged,
115 mm
70mm regular spread



CM23-086 - 094
Medial Toothed Blades
Stainless Steel



CM23-095 - 099
Small Lateral Blades
Stainless Steel



CM23-100 - 106
Lateral Serrated Blades
Stainless Steel



Cervical Blades
Stainless Steel – fenestrated



CM23-109 - 117
Blunt Blades
Stainless Steel



CM23-118 - 122
Medial Toothed Blades
Aluminium – rotatating



CM23-123 - 127
Lateral Serrated Blades
Aluminium – rotatating



CM23-128 - 132
Blunt Blades
Aluminium – rotatating



**CASPAR
CM23-133**
Transverse Retractor hinged
65 mm spread

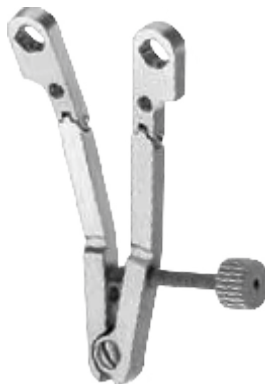

**CASPAR
CM23-134**
Specula Retractor single-hinged
115 mm,
70 mm spread



**CASPAR
CM23-135**
Longitudinal Retractor
single-hinged ring handle
175 mm
70 mm spread



CM23-136 - 143
CM23-136 20 x 40 mm
CM23-137 20 x 45 mm
CM23-138 20 x 50 mm
CM23-139 20 x 55 mm
CM23-140 20 x 60 mm
CM23-141 20 x 65 mm
CM23-142 20 x 70 mm
CM23-143 20 x 75 mm
Medial Toothed Blades



CM23-144 - 154
CM23-144 20 x 25 mm
CM23-145 20 x 30 mm
CM23-146 20 x 35 mm
CM23-147 20 x 40 mm
CM23-148 20 x 45 mm
CM23-149 20 x 50 mm
CM23-150 20 x 55 mm
CM23-151 20 x 60 mm
CM23-152 20 x 65 mm
CM23-153 20 x 70 mm
CM23-154 20 x 75 mm
Lateral Serrated Blades



CM23-155 - 164
CM23-155 20 x 30 mm
CM23-156 20 x 35 mm
CM23-157 20 x 40 mm
CM23-158 20 x 45 mm
CM23-159 20 x 50 mm
CM23-160 20 x 55 mm
CM23-161 20 x 60 mm
CM23-162 20 x 65 mm
CM23-163 20 x 70 mm
CM23-164 20 x 75 mm
Blunt Blades



CM23-165 - 172
CM23-165 20 x 35 mm
CM23-166 20 x 40 mm
CM23-167 20 x 45 mm
CM23-168 20 x 50 mm
CM23-169 20 x 55 mm
CM23-170 20 x 60 mm
CM23-171 20 x 65 mm
CM23-172 0 x 70 mm
Medial Toothed Blades
fenestrated



CM23-173 - 182
CM23-173 20 x 25 mm
CM23-174 20 x 30 mm
CM23-175 20 x 35 mm
CM23-176 20 x 40 mm
CM23-177 20 x 45 mm
CM23-178 20 x 50 mm
CM23-179 20 x 55 mm
CM23-180 20 x 60 mm
CM23-181 20 x 65 mm
CM23-182 20 x 70 mm
Lateral Serrated Blades
Fenestrated



CM23-183 - 191
CM23-183 20 x 35 mm
CM23-184 20 x 40 mm
CM23-185 20 x 45 mm
CM23-186 20 x 50 mm
CM23-187 20 x 55 mm
CM23-188 20 x 60 mm
CM23-189 20 x 65 mm
CM23-190 20 x 70 mm
CM23-191 20 x 75 mm
Blunt Blades Fenestrated



CASPAR
CM23-192
Transverse Retractor hinged
60 mm spread



CASPAR
CM23-193
Transverse Retractor double-hinged
65 mm spread



CASPAR
CM23-194
Longitudinal Retractor
single-hinged ring handle
175 mm
70 mm spread



CASPAR
CM23-195
Longitudinal Retractor
single-hinged ring handle
175 mm
70 mm spread



CM23-196 - 202
CM23-196 12 x 40 mm
CM23-197 12 x 45 mm
CM23-198 12 x 50 mm
CM23-199 12 x 55 mm
CM23-200 12 x 60 mm
CM23-201 12 x 65 mm
CM23-202 12 x 75 mm
 Small Lateral Serrated
 Blades PEEK



CM23-203 - 209
CM23-203 23 x 40 mm
CM23-204 23 x 45 mm
CM23-205 23 x 50 mm
CM23-206 23 x 55 mm
CM23-207 23 x 60 mm
CM23-208 23 x 65 mm
CM23-209 23 x 75 mm
 Lateral Serrated Blades
 PEEK



CM23-210 - 216
CM23-210 23 x 40 mm
CM23-211 23 x 45 mm
CM23-212 23 x 50 mm
CM23-213 23 x 55 mm
CM23-214 23 x 60 mm
CM23-215 23 x 65 mm
CM23-216 23 x 75 mm
 Blunt Blades PEEK



CM23-217 - 223
CM23-217 23 x 40 mm
CM23-218 23 x 45 mm
CM23-219 23 x 50 mm
CM23-220 23 x 55 mm
CM23-221 23 x 60 mm
CM23-222 23 x 65 mm
CM23-223 23 x 75 mm
 Medial Toothed Blades
 PEEK



CM23-224 - 230
CM23-224 23 x 40 mm
CM23-225 23 x 45 mm
CM23-226 23 x 50 mm
CM23-227 23 x 55 mm
CM23-228 23 x 60 mm
CM23-229 23 x 65 mm
CM23-230 23 x 75 mm
 Lateral Serrated Blades
 PEEK – rotatating



CM23-231 - 237
CM23-231 23 x 40 mm
CM23-232 23 x 45 mm
CM23-233 23 x 50 mm
CM23-234 23 x 55 mm
CM23-235 23 x 60 mm
CM23-236 23 x 65 mm
CM23-237 23 x 75 mm
 Blunt Blades
 PEEK – rotatating

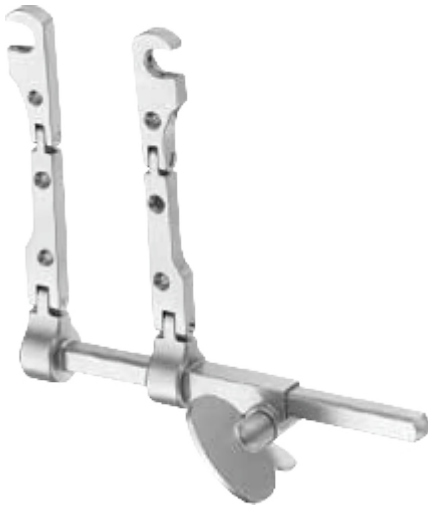

CASPAR
CM23-238
Transverse Retractor double-hinged
quick connect 72 mm spread, side-loading



CASPAR
CM23-239
Longitudinal Retractor double-hinged,
ring handle, quick connect
185 mm
75 mm spread, side-loading



CASPAR
CM23-240
Specula Retractor single-hinged,
quick connect
115 mm
70 mm spread, side-loading



CASPAR
CM23-241
Quick Connect Blade
Positioner Handle
210 mm
for quick connect
blades only



CM23-242 - 246
CM23-242 23 x 40 mm
CM23-243 23 x 45 mm
CM23-244 23 x 50 mm
CM23-245 23 x 55 mm
CM23-246 23 x 60 mm
Medial Toothed Blades
Stainless Steel
quick connect



CM23-247 - 251
CM23-247 23 x 40 mm
CM23-248 23 x 45 mm
CM23-249 23 x 50 mm
CM23-250 23 x 55 mm
CM23-251 23 x 60 mm
Lateral Serrated Blades
Stainless Steel
quick connect



CM23-252 - 256
CM23-252 23 x 45 mm
CM23-253 23 x 50 mm
CM23-254 23 x 55 mm
CM23-255 23 x 60 mm
CM23-256 23 x 65 mm
Blunt Blades
Stainless Steel
quick connect



CM23-257 - 261
CM23-257 23 x 40 mm
CM23-258 23 x 45 mm
CM23-259 23 x 50 mm
CM23-260 23 x 55 mm
CM23-261 23 x 60 mm
Medial Toothed Blades
Titanium
quick connect



CM23-262 - 266
CM23-262 23 x 40 mm
CM23-263 23 x 45 mm
CM23-264 23 x 50 mm
CM23-265 23 x 55 mm
CM23-266 23 x 60 mm
Lateral Serrated Blades
Titanium
quick connect



CM23-267 - CM23-271
CM23-267 23 x 45 mm
CM23-268 23 x 50 mm
CM23-269 23 x 55 mm
CM23-270 23 x 60 mm
CM23-271 23 x 65 mm
Blunt Blades
Titanium
quick connect



CASPAR
CM23-272
Caspar Cervical Spine Retractor
stainless steel, complete set for transverse retraction, 65 mm
spread, adjustable, with 5 medial and 5 lateral stainless steel,
blades 40, 45, 50, 55, 60 mm

CM23-273
TI Caspar Cervical Spine Retractor
titanium, complete set for transverse retraction, 65 mm
spread, adjustable, with 5 medial and 5 lateral titanium
blades 40, 45, 50, 55, 60 mm



CASPAR
CM23-274
Caspar Microdiscectomy Retractor
for microsurgical treatment of
herniated lumbar discs
45 mm spread



CM23-275 - 283
CM23-275 35 mm
CM23-276 40 mm
CM23-277 45 mm
CM23-278 50 mm
CM23-279 55 mm
CM23-280 60 mm
CM23-281 65 mm
CM23-282 75 mm
CM23-283 85 mm
 Lateral Blades



CM23-284 - 290
CM23-284 40 mm
CM23-285 45 mm
CM23-286 50 mm
CM23-287 55 mm
CM23-288 60 mm
CM23-289 65 mm
CM23-290 70 mm
 Paraspina Blades



CASPAR
CM23-291 - 300
CM23-291 40 mm
CM23-292 45 mm
CM23-293 50 mm
CM23-294 55 mm
CM23-295 60 mm
CM23-296 65 mm
CM23-297 70 mm
CM23-298 75 mm
CM23-299 80 mm
CM23-300 85 mm
 Lumbar Speculum
 fenestrated



CM23-305 - 310
CM23-305 20 x 30 mm
CM23-306 20 x 40 mm
CM23-307 20 x 50 mm
CM23-308 20 x 60 mm
CM23-309 20 x 70 mm
CM23-310 20 x 80 mm
 McCulloch 4-teeth
 Narrow Muscle Blades



CM23-311 - 316
CM23-311 20 x 30 mm
CM23-312 20 x 40 mm
CM23-313 20 x 50 mm
CM23-314 20 x 60 mm
CM23-315 20 x 70 mm
CM23-316 20 x 80 mm
 McCulloch 6-teeth
 Wide Muscle Blades

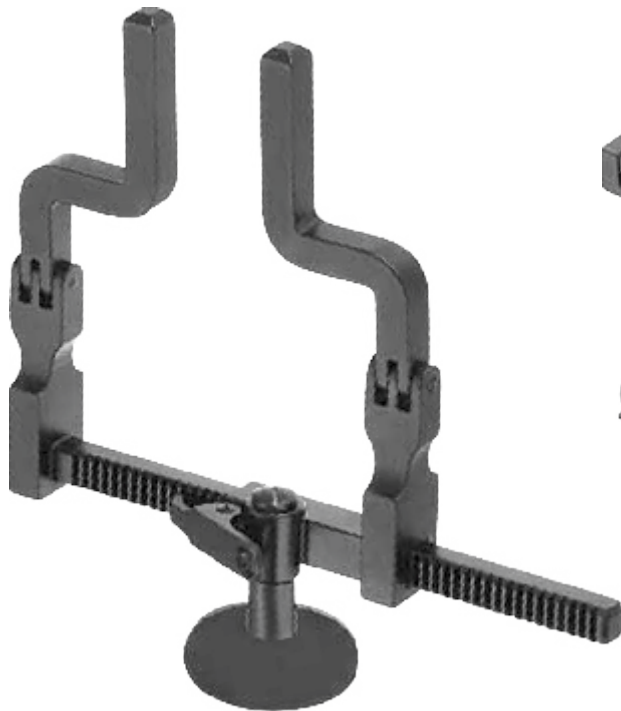

CASPAR
 McCulloch Lumbar Spine Retractor for Microdiscectomy,
 black silicone bead
CM23-301 68 mm spread, hinged
CM23-302 68 mm spread, rigid
CM23-303 90 mm spread, rigid
 McCulloch Lumbar Spine Retractor Tray
CM23-304 Tray 265 x 265 mm for Container (not illustrated)



CM23-317 - 322
CM23-317 20 x 30 mm
CM23-318 20 x 40 mm
CM23-319 20 x 50 mm
CM23-320 20 x 60 mm
CM23-321 20 x 70 mm
CM23-322 20 x 80 mm
 McCulloch 2-teeth
 Thin Muscle Blades



CM23-323 - 330
CM23-323 20 mm
CM23-324 30 mm
CM23-325 40 mm
CM23-326 50 mm
CM23-327 60 mm
CM23-328 70 mm
CM23-329 80 mm
CM23-330 90 mm
 McCulloch Hook Blades



CM23-331 - 338
CM23-331 20 mm
CM23-332 30 mm
CM23-333 40 mm
CM23-334 50 mm
CM23-335 60 mm
CM23-336 70 mm
CM23-337 80 mm
CM23-338 90 mm
 McCulloch toothed
 Hook Blades



CM23-339 - 341
CM23-339 20 x 50 mm
CM23-340 20 x 60 mm
CM23-341 20 x 70 mm
 McCulloch 2-teeth
 Cervical Blades



CASPAR
CM23-342 - 343
 Caspar Vertebral Column Retractor for Laminectomy and Hemilaminectomy (Lumbar, Thoracic, Cervical), stainless steel, complete set, 145 mm spread,
CM23-342 125 mm arms, consisting of
CM23-343 145 mm spread, hinged includes Screw Driver for spreading bar



CASPAR
CM23-344
 Screw driver four spreading bar



CASPAR
CM23-345
 Blade Changing Forceps 115 mm



CM23-346 - 347
CM23-346 38 mm
CM23-347 58 mm



CM23-348 - 355
CM23-348 22 x 32 mm
CM23-349 22 x 37 mm
CM23-350 22 x 43 mm
CM23-351 22 x 47 mm
CM23-352 22 x 52 mm
CM23-353 22 x 57 mm
CM23-354 22 x 62 mm
CM23-355 22 x 67 mm



CM23-356 - 363
CM23-356 37 x 32 mm
CM23-357 37 x 37 mm
CM23-358 37 x 43 mm
CM23-359 37 x 47 mm
CM23-360 37 x 52 mm
CM23-361 37 x 57 mm
CM23-362 37 x 62 mm
CM23-363 37 x 67 mm



CM23-364 - 371
CM23-364 57 x 32 mm
CM23-365 57 x 37 mm
CM23-366 57 x 43 mm
CM23-367 57 x 47 mm
CM23-368 57 x 52 mm
CM23-369 57 x 57 mm
CM23-370 57 x 62 mm
CM23-371 57 x 67 mm



**CASPAR
CM23-372**

Distractor only for use in surgical procedures from the left approach the right approach for the upper cervical spine Distractor as above but with elongated toothed bar for multilevel (more than 2) distraction

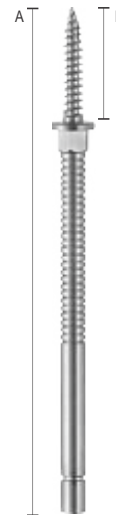

**DISTRACTION PIN A/B
CM23-373 - 376**
CM23-373 66/12 mm
CM23-374 68/14 mm
CM23-375 70/16 mm
CM23-376 72/18 mm



**TWIST DRILL
CM23-377**



**DRILL GUIDE
CM23-378**



**SCREW DRIVER
CM23-379**



CASPAR
CM23-380
Distractor only for use in surgical procedures from the left approach the right approach for the upper cervical spine Distractor as above but with elongated toothed bar for multilevel (more than 2) distraction

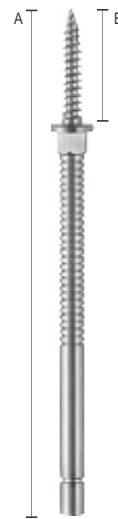

DISTRACTION PIN A/B
CM23-381 - 384
CM23-381 66/12 mm
CM23-382 68/14 mm
CM23-383 70/16 mm
CM23-384 72/18 mm



TWIST DRILL
CM23-385



DRILL GUIDE
CM23-386



SCREW DRIVER
CM23-387



CLOWARD-TYPE
CM23-388
Vertebra Spreaders
130 mm
18 mm spread



CM23-389
one pointed tip
70 mm
arm, 80 mm spread



three pointed tips
CM23-390
850 mm arm,
70 mm spread
CM23-391
100 mm
arm, 70 mm spread



INGE
Lamina Spreaders
CM23-392 - 393
CM23-392 165 mm
CM23-393 270 mm

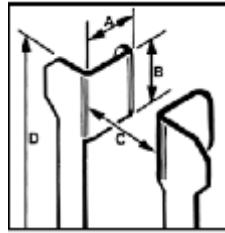

SCOVILLE-HAVERFIELD

	A	B	C	D
CM23-394	50 mm	35 mm	140 mm	140 mm
	50 mm			
with 1 each blade 29-3165.50 and 29-3162.51				
Frame only, hinged:				
CM23-395			140 mm	140 mm



Toothed:

- CM23-402 - 407**
- CM23-402** 63 mm x 26 mm
- CM23-403** 66 mm x 30 mm
- CM23-404** 89 mm x 26 mm
- CM23-405** 51 mm x 51 mm
- CM23-406** 63 mm x 51 mm
- CM23-407** 76 mm x 51 mm



3-prongs:

CM23-396 44 mm x 38 mm

4-prongs:

- CM23-397 - 401**
- CM23-397** 41 mm x 38 mm
- CM23-398** 66 mm x 48 mm
- CM23-399** 48 mm x 51 mm
- CM23-400** 63 mm x 63 mm
- CM23-401** 82 mm x 58 mm



Hook-shaped, blunt:

- CM23-408 - 409**
- CM23-408** 50 mm
- CM23-409** 75 mm



Williams
CM23-410
for microsurgical treatment
of herniated discs
170 mm
w = 10 mm
CM23-411 10 x 50 mm
CM23-412 10 x 60 mm
CM23-413 10 x 70 mm

w = 20 mm
CM23-414 20 x 50 mm
CM23-415 20 x 60 mm
CM23-416 20 x 70 mm



Williams
CM23-417
for microsurgical treatment
of herniated discs
170 mm
w = 10 mm
CM23-418 10 x 50 mm
CM23-419 10 x 60 mm
CM23-420 10 x 70 mm

w = 20 mm
CM23-421 20 x 50 mm
CM23-422 20 x 60 mm
CM23-423 20 x 70 mm



CLOWARD-TYPE
CM23-424
 with slide lock Cervical Retractor Set with
 slide-lock complete with 14 blades, 25 cm
CM23-425 – CM23-426
CM23-427 Retractor Body only (without blades), 25 cm



CM23-428
 Cervical Retractor Set with
 slide-lock complete with 14 blades, 16 cm
CM23-429 – CM23-430
CM23-431 Retractor Body only (without blades),
 160 mm



CM23-432 - 438
CM23-432 25 mm
CM23-433 30 mm
CM23-434 35 mm
CM23-435 40 mm
CM23-436 45 mm
CM23-437 50 mm
CM23-438 55 mm
 blunt



CM23-439 - 445
CM23-439 25 mm
CM23-440 30 mm
CM23-441 35 mm
CM23-442 40 mm
CM23-443 45 mm
CM23-444 50 mm
CM23-445 55 mm
 blunt

Galea Hooks



YASARGIL
CM23-446
31 cm

YASARGIL
CM23-447
41 cm

Dura Protecting Forceps

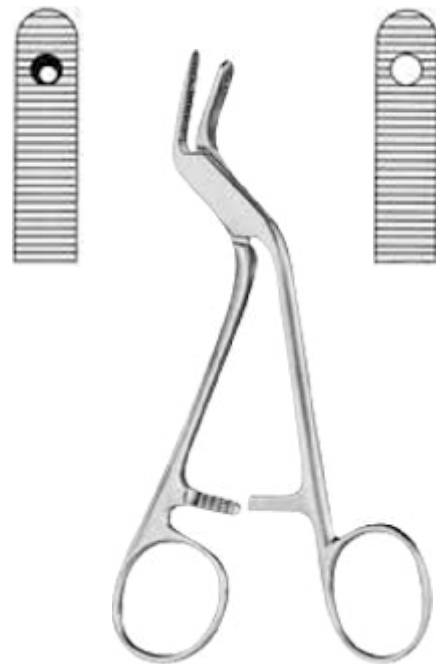

ADSON
CM23-448
15 cm



CM23-449
Silver Wires Mckenzie

Elio Carrier



MCKENZIE
CM23-450
148x40x60 mm
One Clip Holding



MCKENZIE
CM23-451
190x48x13 mm
Two Clips Holding

Silver Clips



CM23-452



CM23-453
Complete Brain Traction
Set With 1 Arm



CM23-455
Complete Set

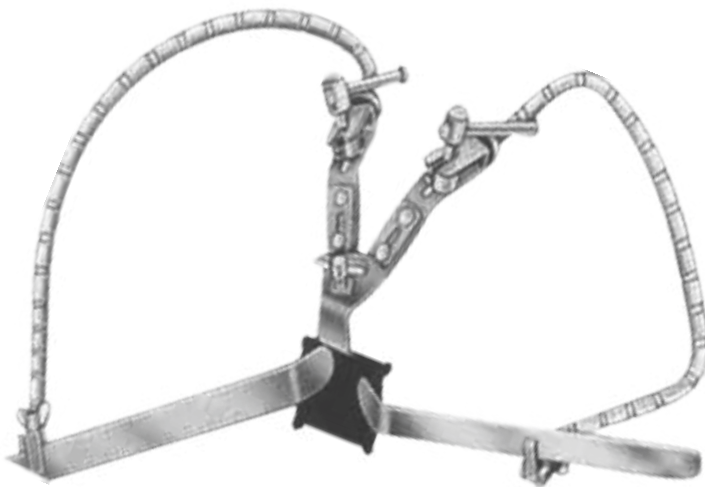

CM23-454
Complete Brain Traction
Set With 2 Arm

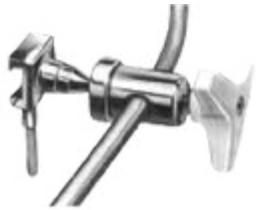

CM23-456
Ball and Socket Joint



CM23-457
Holding Rod, Head



CM23-458
Coupling Head



CM23-459
Fixation Base for skull
Mounting Holding 1
Flexible Arm



CM23-460
Fixation Base for skull
Mounting, Holding 2
Flexible Arms



CM23-461
Fixation Base for
Mounting to 16 mm Dia.
Holding 1 Flexible Arm

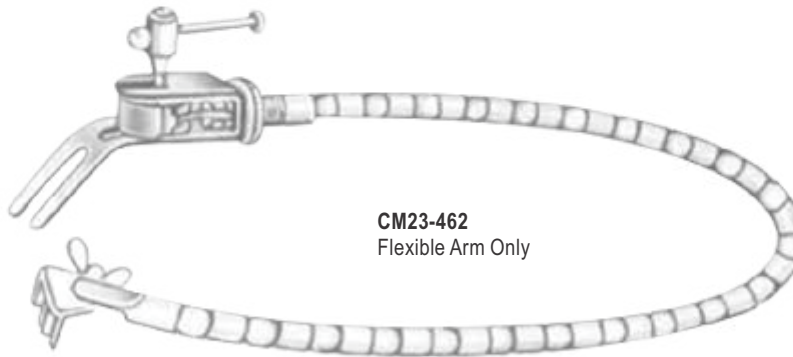

CM23-462
Flexible Arm Only



CM23-463
Support for Flat
Brain Spatula



CM23-464
Support for Brain Spatula
With Round Shaft



CM23-465
Held for Ear Spatula



CARE MEDICAL[®]
S U P P L I E S

Your health _ Our Priority

Section

24

Page 497-533

Ear Curettes And Sharp Spoons
Ear Forceps And Micro Ear Forceps
Micro Ear Raspatories And Probes Ear Sickle knives
Currcular Cutting Knife
Micro Instruments For Laryngo - Broncho
Mouth Gags, Lip And Cheek Retractors
Rasps Without Tungsten Carbide
Nasal Polypus And Septum Forceps
Rasps Without Tungsten Carbide
Septum Forceps And Scissor
Exchangeable Tips
Laryngeal Mirrors



¼

ZÖLLNER
CM24-001 - 006
set for adults, black



CM24-001
Fig.1
5.5 X 6.5 mm Ø



CM24-002
Fig.2
6.5 X 7.5 mm Ø



CM24-003
Fig.3
7.5 X 8.5 mm Ø



CM24-004
Fig.4
8.5 X 9.5 mm Ø



CM24-005
Fig.5
9.5 X 10.5 mm Ø

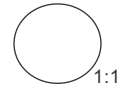

CM24-006
Fig.6
10.5 X 11.5 mm Ø



¼

POLITZER
CM24-007 - 010
set for adults



CM24-007
Fig.1
2 mm Ø



CM24-008
Fig.2
3 mm Ø



CM24-009
Fig.3
4 mm Ø



CM24-010
Fig.4
5 mm Ø



¼

BOUCHERON
CM24-011 - 013
set for children



CM24-011
Fig.0
3.0 mm Ø



CM24-012
Fig.1
4.5 mm Ø



CM24-013
Fig.2
5.5 mm Ø



¼

HARTMANN
CM24-014 - 017
set for adults



CM24-014
Fig.1
4.5 mm Ø



CM24-015
Fig.2
5.5 mm Ø



CM24-016
Fig.3
6.5 mm Ø



CM24-017
Fig.4
7.5 mm Ø



BUCK
CM24-018 - 033
 Blunt
 Sharp
 165 mm - 6½"



CM24-018
 Fig.000



CM24-019
 Fig.00



CM24-020
 Fig.0



CM24-021
 Fig.1



CM24-022
 Fig.2



CM24-023
 Fig.3



CM24-024
 Fig.4



CM24-025
 Fig.5



CM24-026
 Fig.000



CM24-027
 Fig.00



CM24-028
 Fig.0



CM24-029
 Fig.1



CM24-030
 Fig.2



CM24-031
 Fig.3



CM24-032
 Fig.4



CM24-033
 Fig.5



BUCK
CM24-034 - 049
 Curved, blunt
 Curved, sharp
 165 mm - 6½"



CM24-034
 Fig.000



CM24-035
 Fig.00



CM24-036
 Fig.0



CM24-037
 Fig.1



CM24-038
 Fig.2



CM24-039
 Fig.3



CM24-040
 Fig.4



CM24-041
 Fig.5



CM24-042
 Fig.000



CM24-043
 Fig.00



CM24-044
 Fig.0



CM24-045
 Fig.1



CM24-046
 Fig.2



CM24-047
 Fig.3



CM24-048
 Fig.4



CM24-049
 Fig.5

Picture Show The Outer Diameter



LANGENBECK
CM24-050
Blunt
130 mm - 5"



JANSEN
CM24-051
Sharp
170 mm - 6 3/4"



GROSS
CM24-052
Sharp, not fenestrated
120 mm - 4 3/4"



CM24-053
Blunt, fenestrated
120 mm - 4 3/4"



JANSEN
CM24-054
Sharp
160 mm - 6 1/4"



BILLEAU
CM24-055 - 057
 165 mm - 6½"

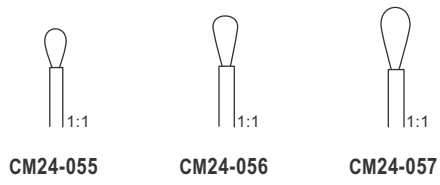

CM24-055 **CM24-056** **CM24-057**



LUCAE
CM24-058 - 060
 140 mm - 5½"



CM24-058 **CM24-059** **CM24-060**



WAGENER
CM24-061 - 067
 140 mm - 5½"

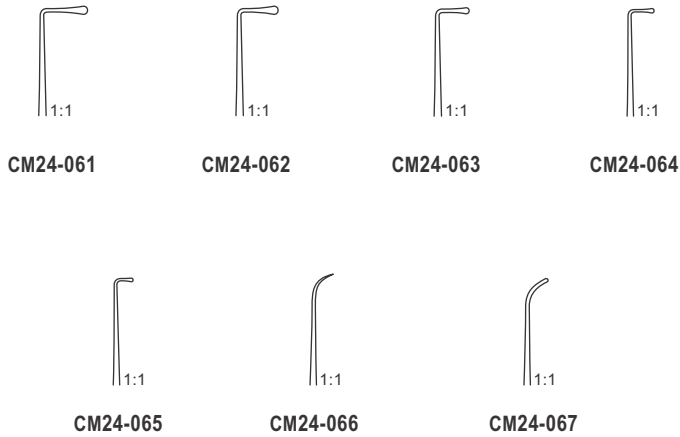

CM24-061 **CM24-062** **CM24-063** **CM24-064**
CM24-065 **CM24-066** **CM24-067**



POLITZER
CM24-068
150 mm - 6"

1:2

CM24-068 - 070



GERZOG
CM24-069
160 mm - 6 1/4"



BUCK
CM24-070
160 mm - 6 1/4"



1:2

LUCAE
CM24-071
180 mm - 7"



1:2

LUCAE
CM24-072
180 mm - 7"



1:2

LUCAE
CM24-073
190 mm - 7 1/2"



1:2

POLITZER
CM24-074
170 mm - 7 3/4"



1:2

POLITZER
CM24-075
needle vertical
160 mm - 6 1/4"



1:2

CM24-076
Needle horizontal
160 mm - 6 1/4"

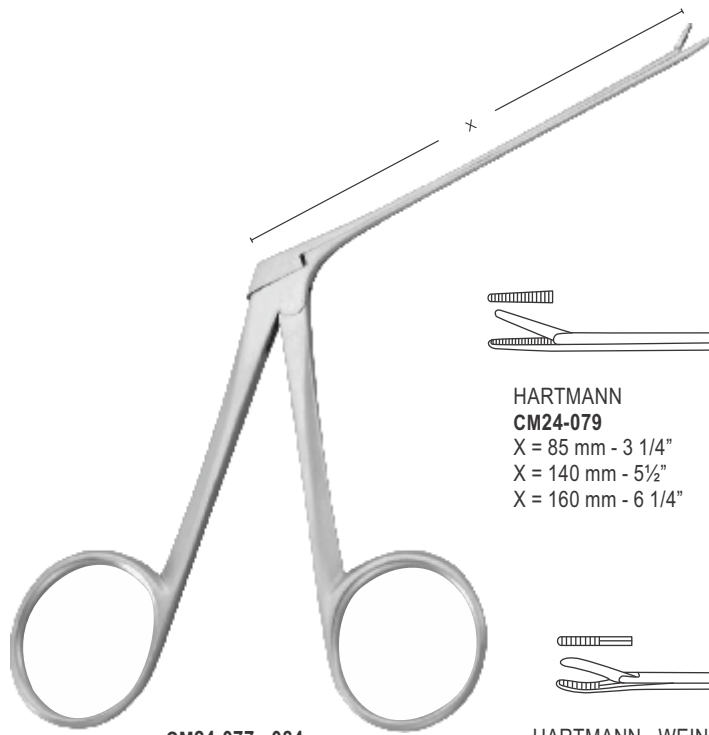

CM24-077 - 084

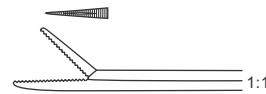

**HARTMANN - WULLSTEIN
CM24-077**
X = 85 mm - 3 1/4"



**HARTMANN - WULLSTEIN
CM24-078**
X = 85 mm - 3 1/4" 1 mm ϕ



**HARTMANN
CM24-079**
X = 85 mm - 3 1/4"
X = 140 mm - 5 1/2"
X = 160 mm - 6 1/4"

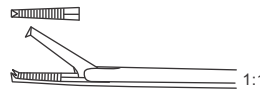

**HARTMANN
CM24-080**
X = 85 mm - 3 1/4"
X = 140 mm - 5 1/2"

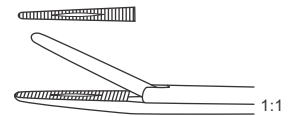

**HARTMANN - NOYES
CM24-081**
X = 90 mm - 3 1/2"



**HARTMANN - WEINGARTNER
CM24-082**
X = 85 mm - 3 1/4"



**HARTMANN
CM24-083**
X = 85 mm - 3 1/4"
2.0 mm ϕ
2.5 mm ϕ
3.0 mm ϕ

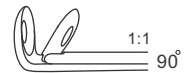
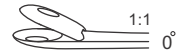

**STRUEMPEL
CM24-084**
X = 85 mm - 3 1/4"

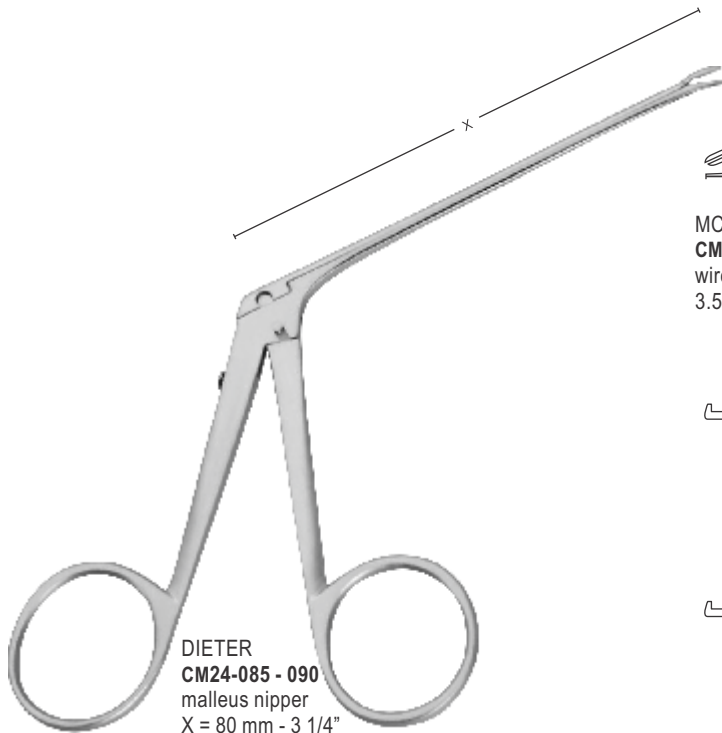

**DIETER
CM24-085 - 090**
malleus nipper
X = 80 mm - 3 1/4"

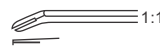

**MCGEE
CM24-085**
wire bending forceps
3.5 mm X 0.8 mm



**FULLER
CM24-086**
introducing forceps
for teflon prosthesis
80 mm - 3 1/4"



CM24-087
Up - cutting



CM24-088
Down - cutting



CM24-089
Right - cutting



CM24-090
Left - cutting



CM24-091 - 095

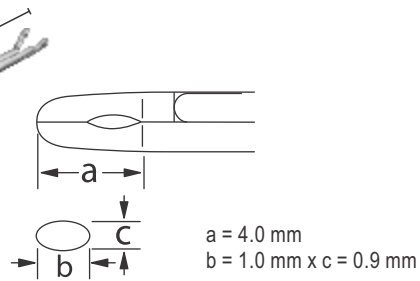

CM24-091
Straight, oval
X = 75 mm - 3"



CM24-092
Curved upwards, oval
X = 75 mm - 3"



CM24-093
Curved to left, oval
X = 75 mm - 3"



CM24-094
Curved to right, oval
X = 75 mm - 3"



CM24-095
Curved downwards, oval
X = 75 mm - 3"

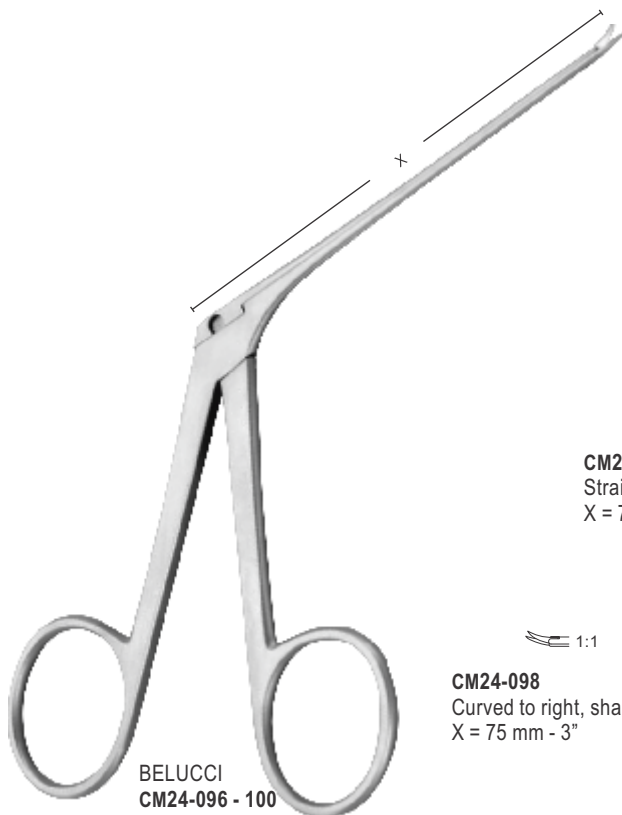

BELUCCI
CM24-096 - 100

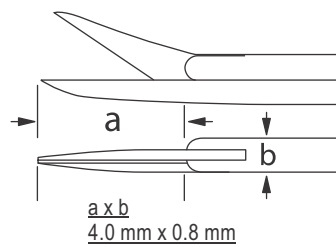

CM24-096
Straight, sharp/sharp
X = 75 mm - 3"



CM24-097
Curved upwards, blunt/blunt
X = 75 mm - 3"



CM24-098
Curved to right, sharp/sharp
X = 75 mm - 3"



CM24-099
Curved to left, sharp/sharp
X = 75 mm - 3"



CM24-100
straight, sharp/blunt
X = 75 mm - 3"



PLESTER
CM24-101 - 106
160 mm - 6 1/4"



WIRE GUIDE
CM24-101



RASPATORY
CM24-102



RASPATORY
CM24-103
1.8 mm



CM24-104
Dissector, double curved right



CM24-105
Instrument for placing wire prosthesis



CM24-106
Dissector, double curved left



ROSEN
CM24-107 - 113
160 mm - 6 1/4"

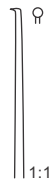

CM24-107
Circular cutting knife
1.5 mm \varnothing 90°



CM24-108
Tympanum knife
45°



CM24-109
Lancet knife
45°



CM24-110
Lancet knife



RASPATORY
CM24-111
Zollner
1 mm



CM24-112
Sickle knife, slightly curved



CM24-113
discision knife, straight curved



CM24-114
Needle fine, straight, sharp
160 mm - 6 1/4"



CM24-115
Needle, slightly curved, sharp
160 mm - 6 1/4"



CM24-116
Needle, strong curved, sharp
160 mm - 6 1/4"



SHAMBAUGH
CM24-117
45° Hook, angled
160 mm - 6 1/4"



PLESTER
CM24-118
0.4 mm - 90°
foot plate hook, angled, blunt
160 mm - 6 1/4"



PLESTER
CM24-119
0.4 mm - 45°
Antrum hook, angled, blunt
160 mm - 6 1/4"



FISCH
CM24-120
Angled to the right
155 mm - 6"



CM24-121
Angled to the left
155 mm - 6"

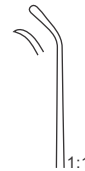

CM24-122
Angled to the right
155 mm - 6"



CM24-123
Angled to the left
155 mm - 6"



**HOUSE
CM24-124**
spoon, strong curved
spoon, slightly curves
170 mm - 6 3/4"



**SHEA
CM24-125**
straight
160 mm - 6 1/4"
1.5 mm X 2.5 mm



**SHEA
CM24-126**
curved
160 mm - 6 1/4"
1.5 mm X 2.5 mm



1:2

CITELLI
CM24-127 - 129
X = 60 mm
170 mm - 6 3/4"



CM24-127
1.5 mm



CM24-128
2.2 mm



CM24-129
3.0 mm



1:2

CM24-130 - 133
200 mm - 8"
X = 80 mm



CM24-130
3 X 3 mm



CM24-131
4 X 4 mm



CM24-132
5 X 5 mm



CM24-133
6 X 6 mm

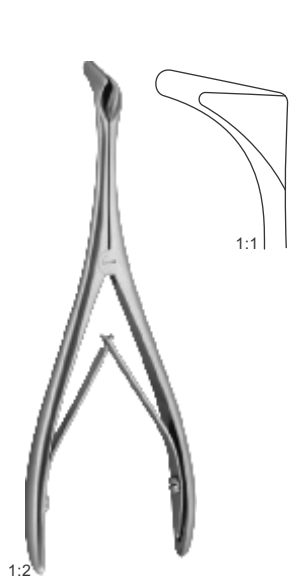

1:2
TIECK - HALLE
CM24-134
 for babies
 135 mm - 5 1/4"



1:2
BECKMANN
CM24-135
 150 mm - 6"



1:2
MOD. WIEN
CM24-136
 145 mm - 5 3/4"

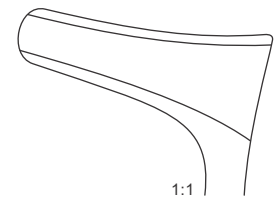
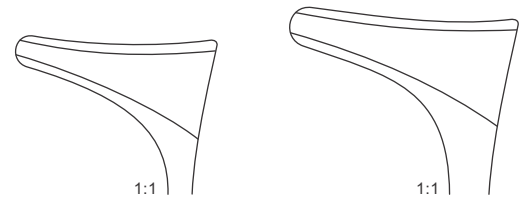

1:2
CM24-137 - 140
KILLIAN
 130 mm - 5"

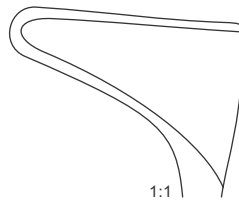

1:1
CM24-137
 X = 35 mm

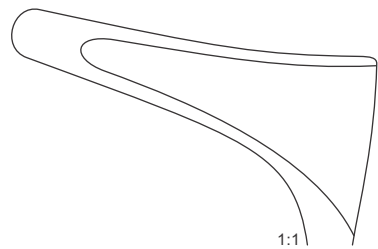

1:1
CM24-138
 X = 50 mm

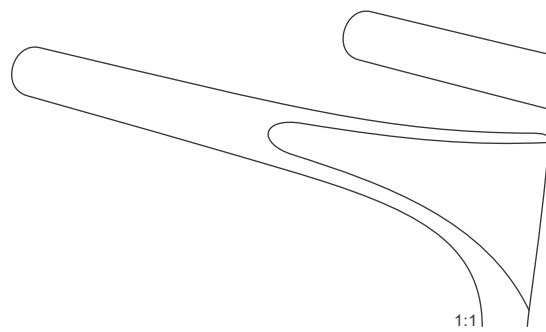

1:1
CM24-139
 X = 75 mm

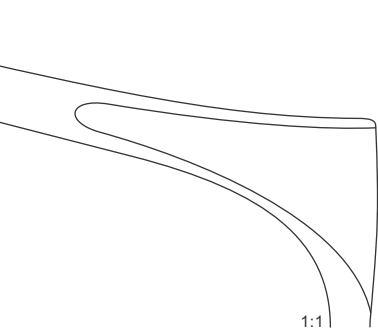

1:1
CM24-140
 X = 90 mm



WESTMACOTT
CM24-141
200 mm - 8"

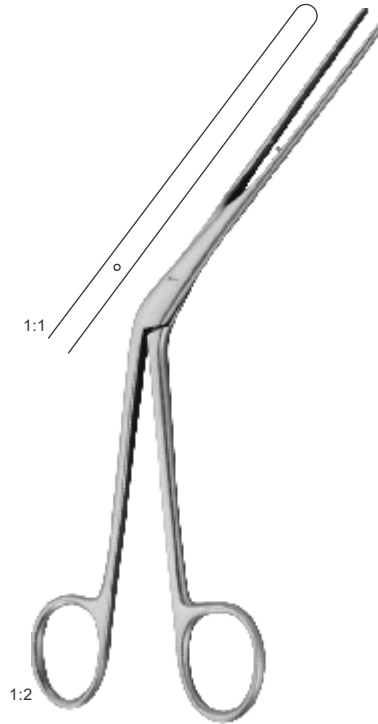

LUBET - BARBON
CM24-142
200 mm - 8"



HARTMANN
CM24-143
160 mm - 6 1/4"
200 mm - 8"

Nasal Dressing Forceps

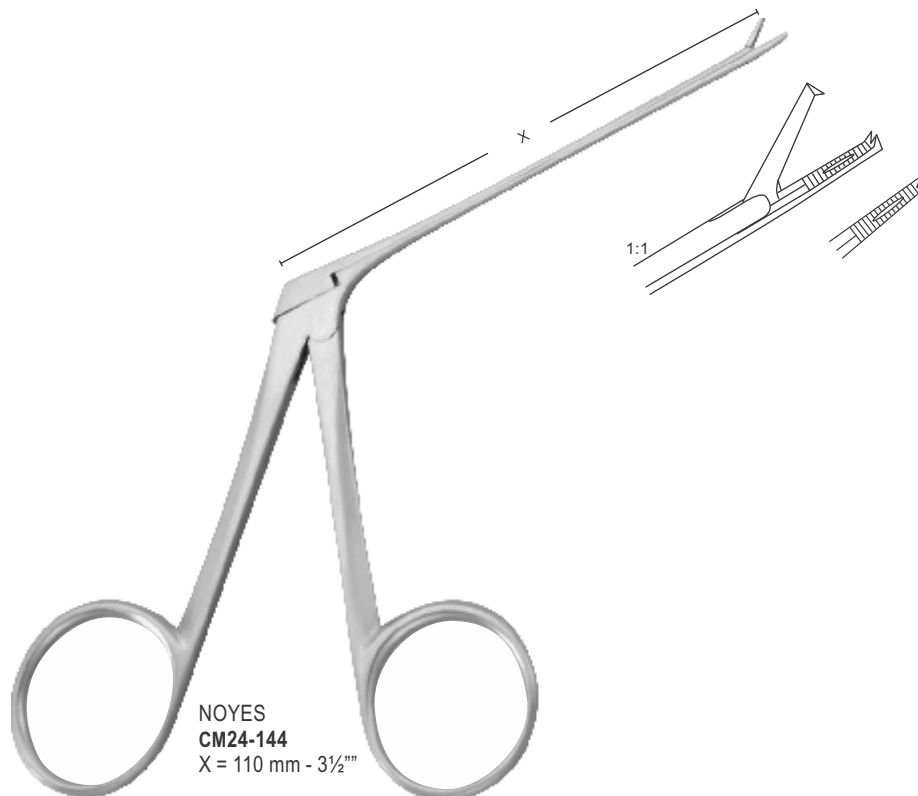

NOYES
CM24-144
X = 110 mm - 3 1/2"

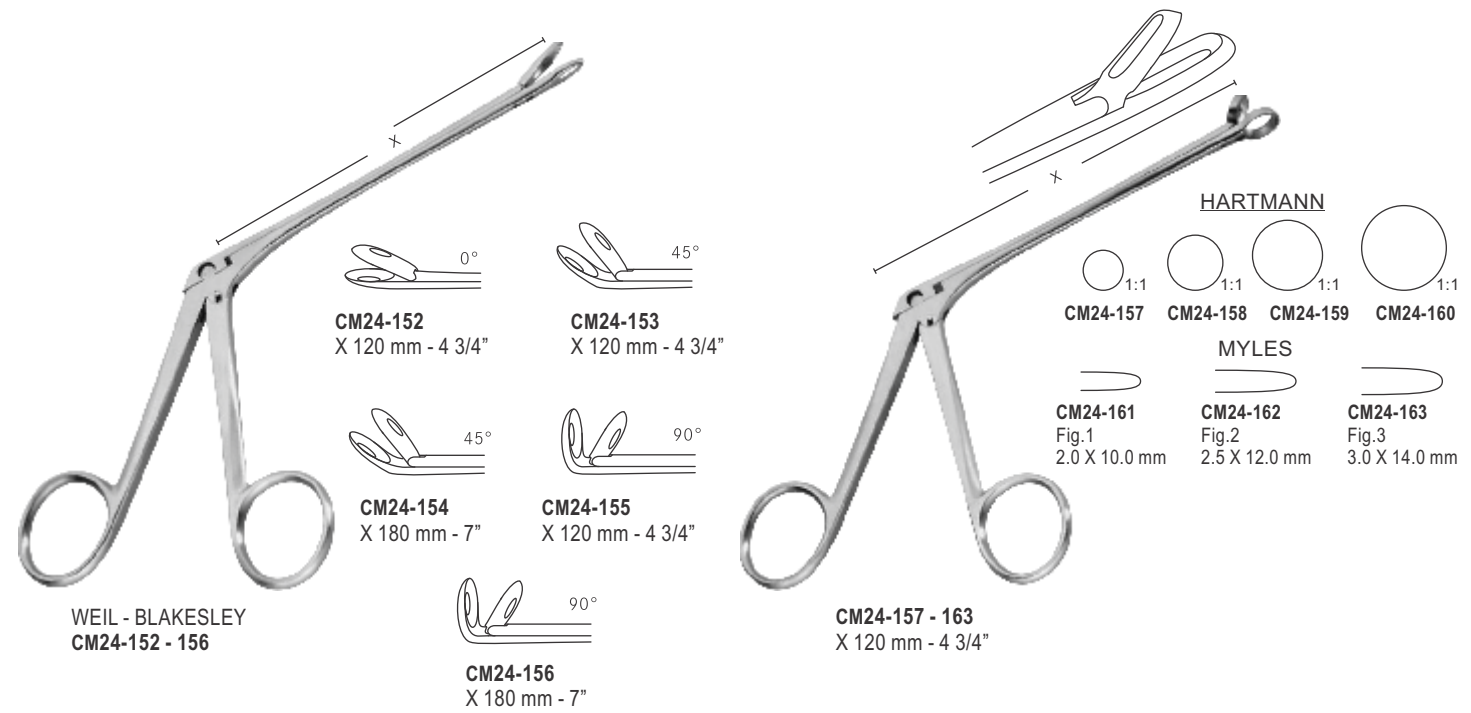
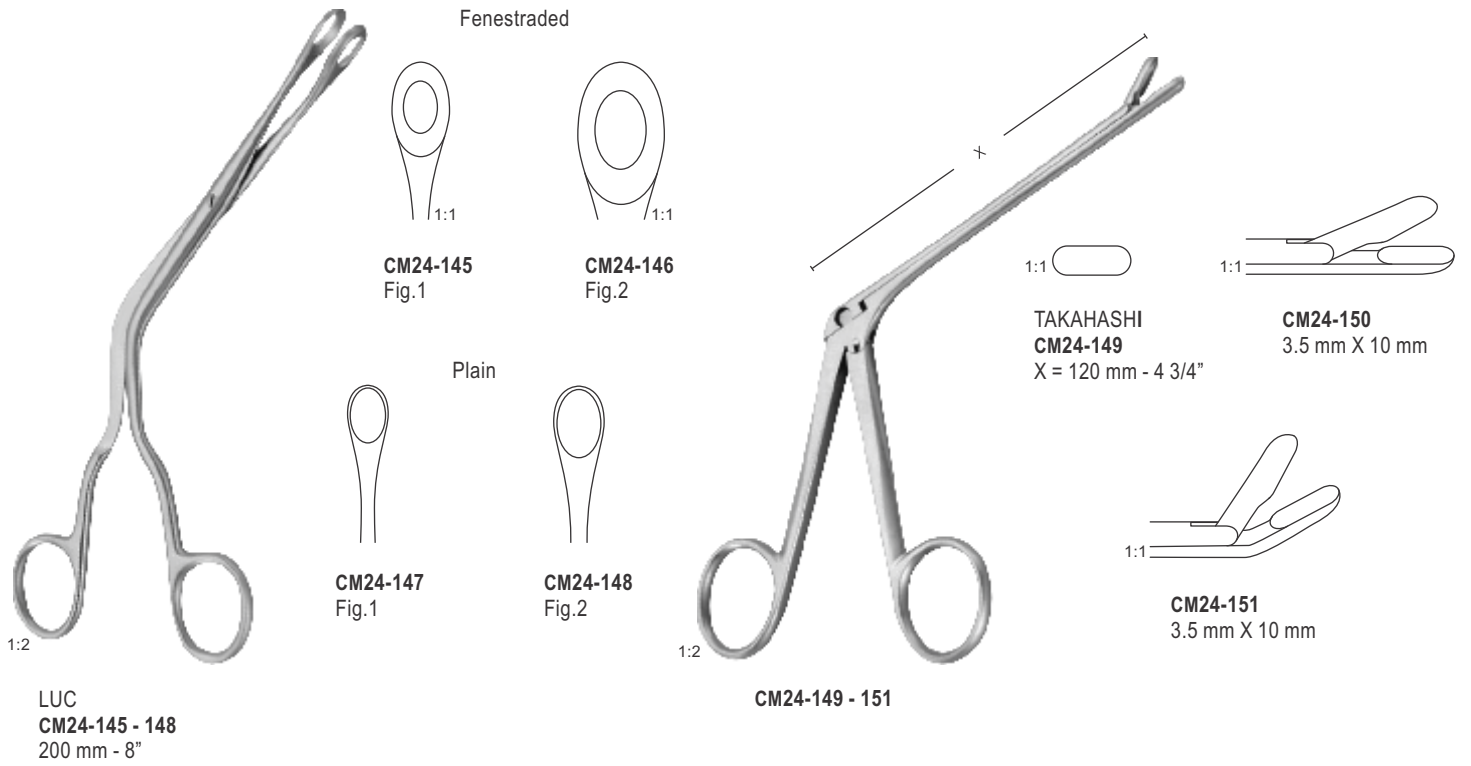

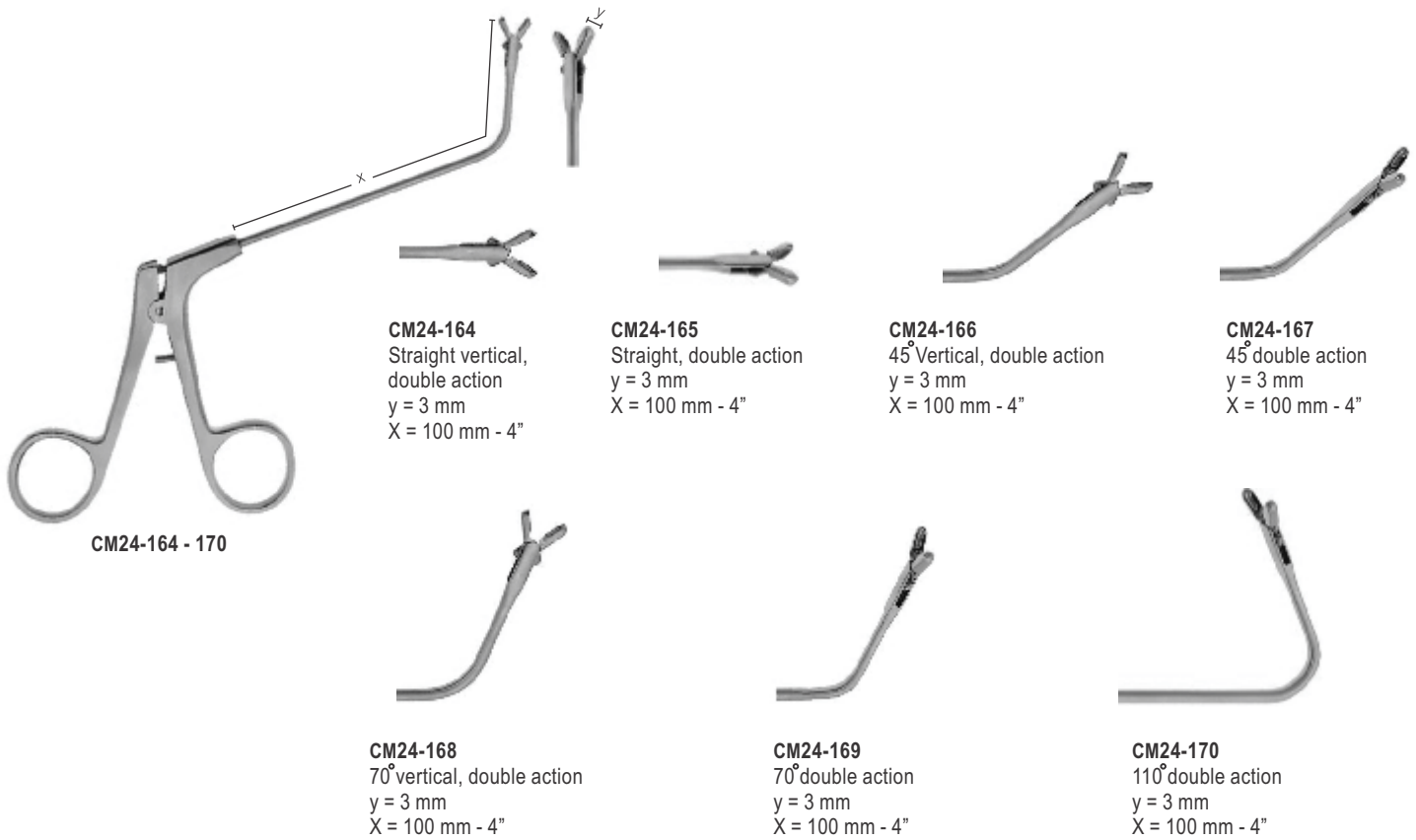

CIRCULAR FORCEPS AND ANTRUM PUNCH

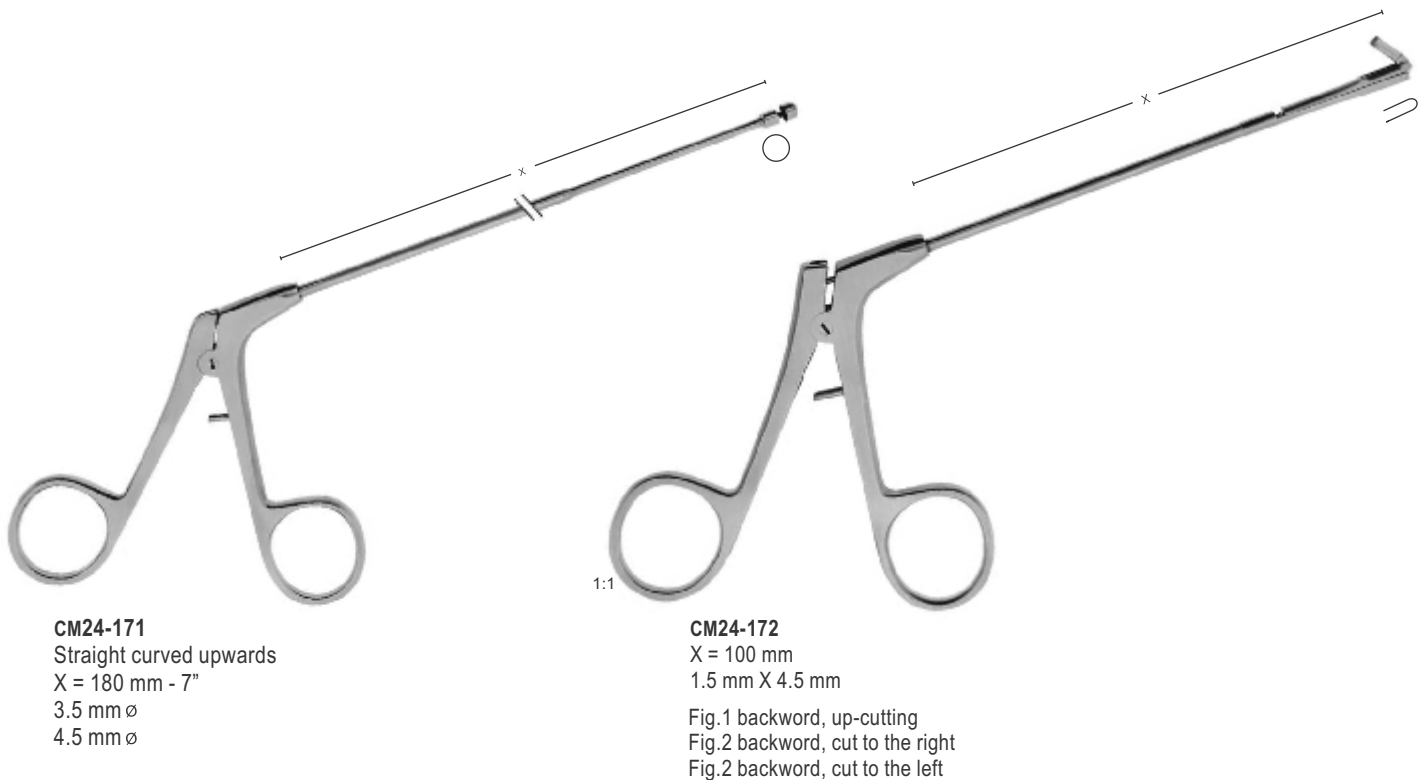



1:2
FREER
CM24-173
210 mm - 8 1/4"



1:2
FREER
CM24-174
210 mm - 8 1/4"



1:2
SICKLE KNIFE
CM24-175
200 mm - 8"



1:2
BRUNINGS
CM24-176
230 mm - 9"



1:2
ABRAHAM
CM24-177
220 mm - 8 3/4"



1:2
FISCHER
CM24-178
230 mm - 9"



1:2
SHARP
CM24-179
200 mm - 8"



1:2
LEMPERT
CM24-180
200 mm - 8"
X = 6 mm

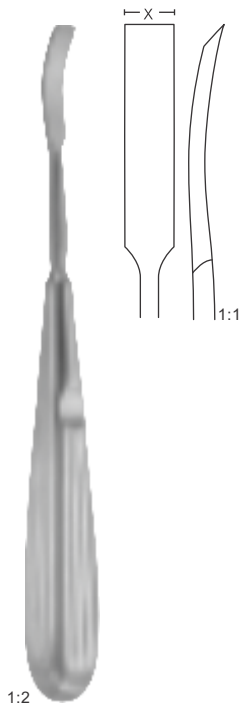

1:2
LEMPERT
CM24-181
180 mm - 7"

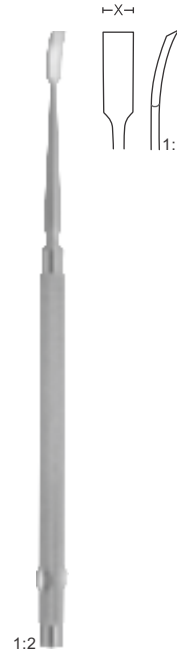

1:2
FREER
CM24-182
160 mm - 6 1/4"
X = 4 mm

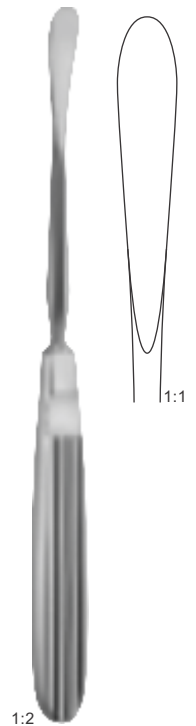

1:2
COTTLE
CM24-183
sharp
190 mm - 7 1/2"
X = 8 mm

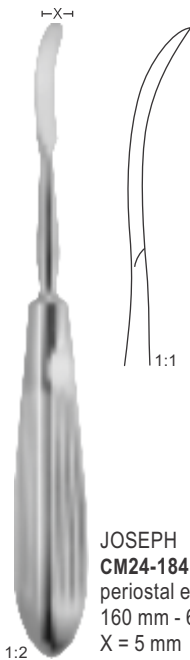

1:2
JOSEPH
CM24-184
periosteal elevators
160 mm - 6 1/4"
X = 5 mm



1:2
SEWALL
CM24-185
antrum elevators
200 mm - 8"



1:2
HALLE
CM24-186
antrum elevators
160 mm - 6 1/4"



MASING
CM24-187
 200 mm - 8"

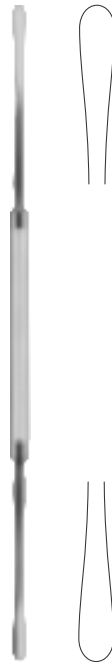

BALLENGER - HAJEK
CM24-188
 190 mm - 7 1/4"
 220 mm - 8 3/4"

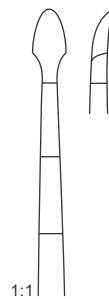

COTTLE
CM24-189
 220 mm - 8 3/4"

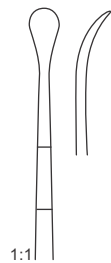

COTTLE
CM24-190
 210 mm - 8 1/4"

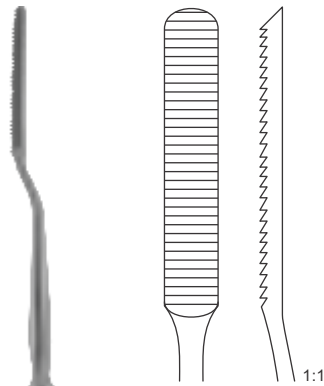

1:2

COTTLE
CM24-191
210 mm - 8 1/4"

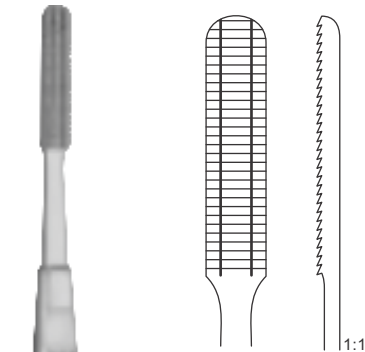

1:2

MALTZ
CM24-192 - 193

1900-192
Drawing cut
170 mm - 6 3/4"
34 mm X 7 mm

1900-193
Pushing cut
170 mm - 6 3/4"
34 mm X 7 mm

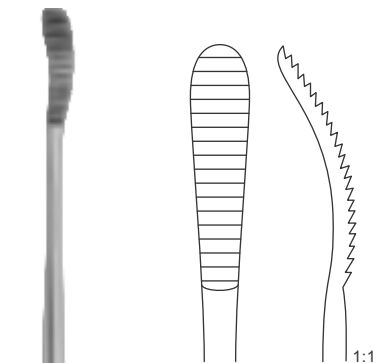

1:2

AUFRICHT
CM24-194 - 195

CM24-194
Pushing cut
210 mm - 8 1/4"

CM24-195
Drawing cut
210 mm - 8 1/4"



CM24-196 - 205
200 mm - 8"

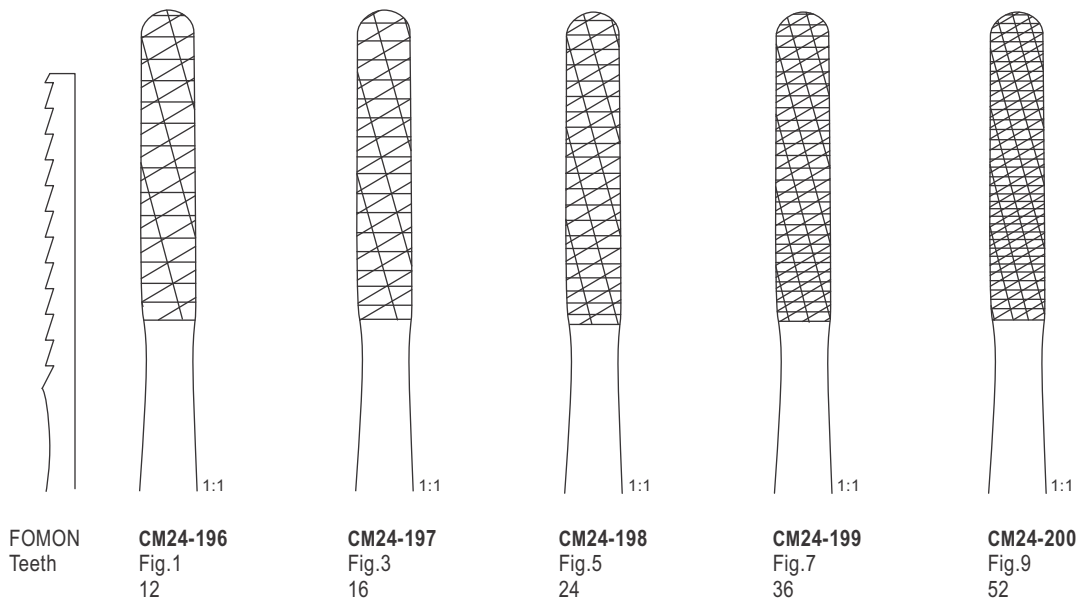

FOMON Teeth
CM24-196 Fig.1 12
CM24-197 Fig.3 16
CM24-198 Fig.5 24
CM24-199 Fig.7 36
CM24-200 Fig.9 52

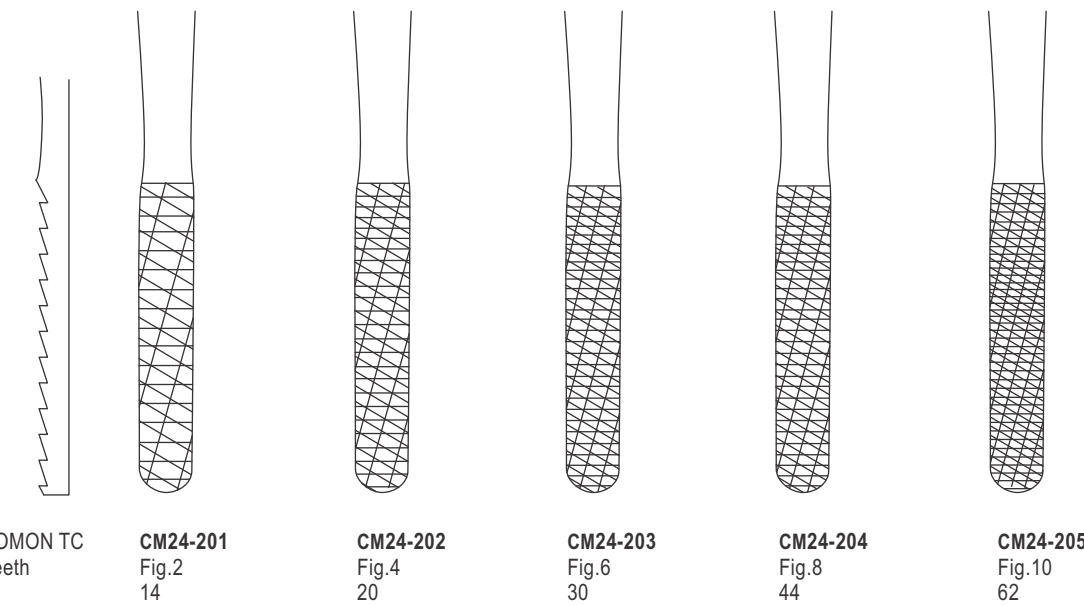

FOMON TC Teeth
CM24-201 Fig.2 14
CM24-202 Fig.4 20
CM24-203 Fig.6 30
CM24-204 Fig.8 44
CM24-205 Fig.10 62



CM24-206 - 208



1:2

CM24-206
Straight



1:2

CM24-207
Left

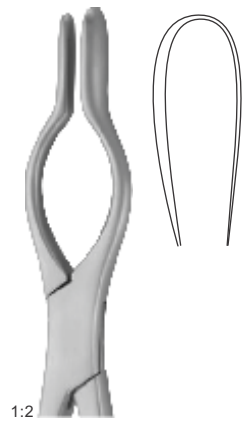

1:2

CM24-208
Right



1:2

ASCH
CM24-209
230 mm - 9"

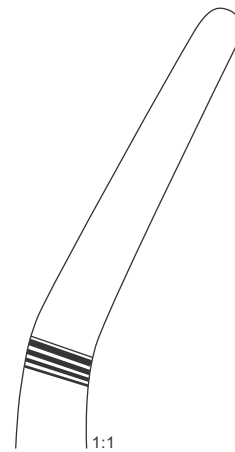

1:1

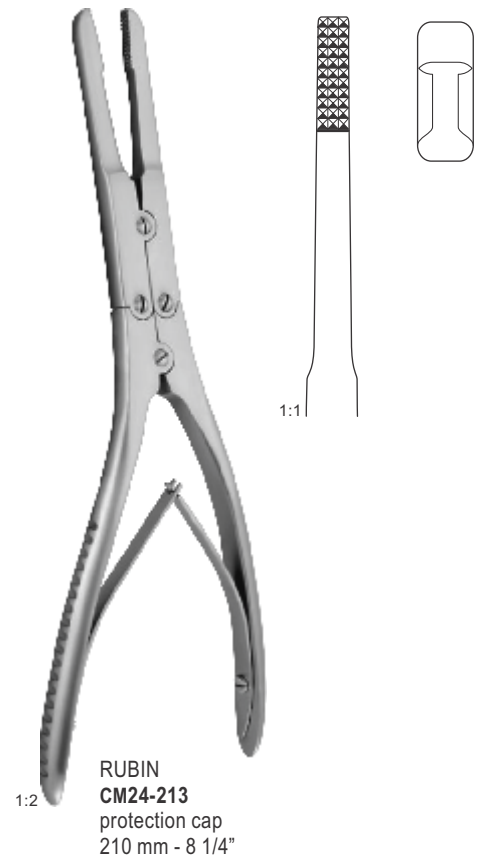
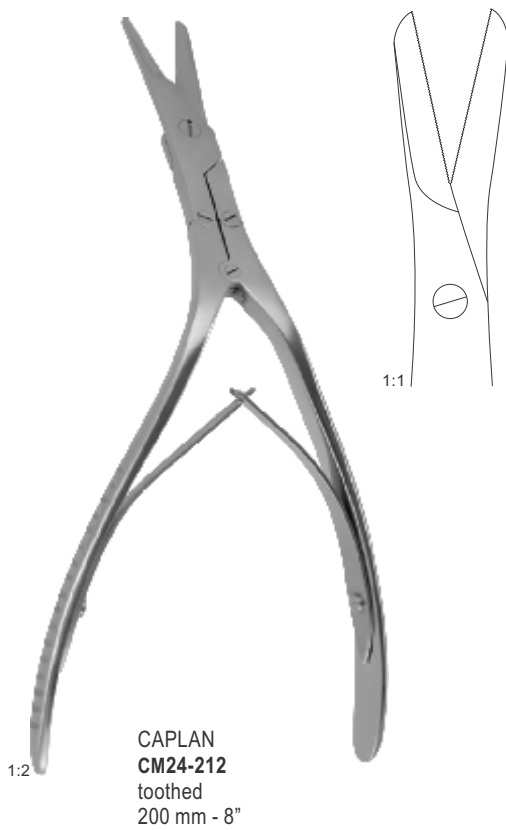
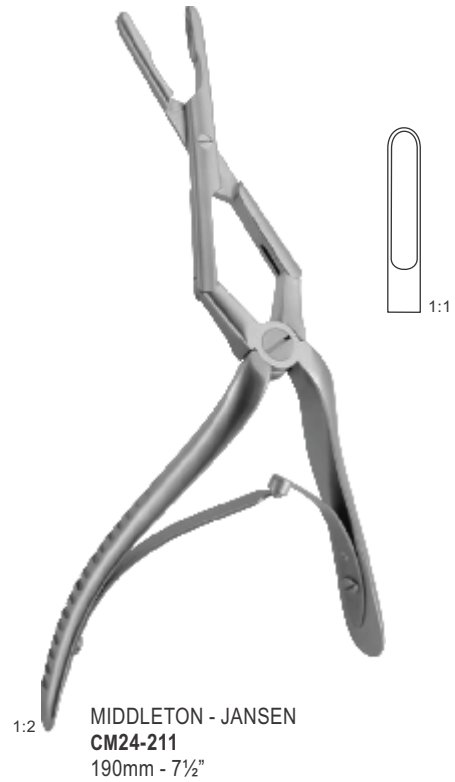



1:2
ST. CLAIR-THOMSON
CM24-214
210 mm - 8 1/4"

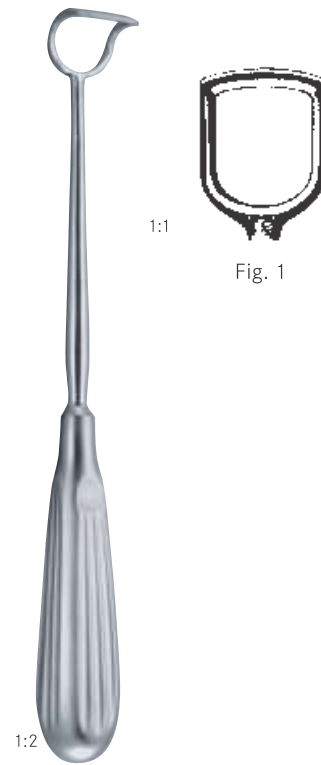

1:2
BARNHILL
CM24-215
220 mm - 8 3/4"



BECKMANN
CM24-216
Straight Curved
220 mm - 8 3/4"

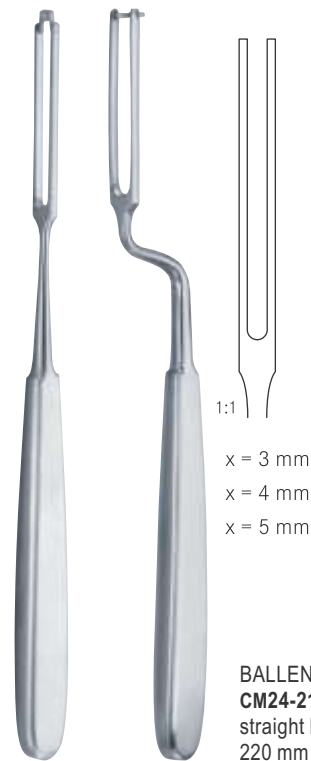

BALLENGER
CM24-217
straight bayonet
220 mm - 8"



1:2

MOLT
CM24-218
for children
110 mm - 4 1/4"



1:2

MOLT
CM24-219
for adults
140 mm - 5 1/2"



1:2

DENHART
CM24-220
120 mm - 4 3/4"



1:2

FERGUSON - ACKLAND
CM24-221
145 mm - 5 3/4"



ROSER - KÖNIG
CM24-222
160 mm - 6 1/4"
190 mm - 7 1/2"



CM24-223 - 233

- CM24-223 Fig. 00 8 mm Ø
- CM24-224 Fig. 0 10 mm Ø
- CM24-225 Fig. 1 12 mm Ø
- CM24-226 Fig. 2 14 mm Ø
- CM24-227 Fig. 3 16 mm Ø
- CM24-228 Fig. 4 18 mm Ø
- CM24-229 Fig. 5 20 mm Ø
- CM24-230 Fig. 6 22 mm Ø
- CM24-231 Fig. 7 24 mm Ø
- CM24-232 Fig. 8 26 mm Ø
- CM24-233 Fig. 9 28 mm Ø
- CM24-233 Fig. 10 30 mm Ø



1:2

CM24-234
100 mm - 4"



CM24-235 - 246

- CM24-235 Fig. 00 8 mm Ø
- CM24-236 Fig. 0 10 mm Ø
- CM24-237 Fig. 1 12 mm Ø
- CM24-238 Fig. 2 14 mm Ø
- CM24-239 Fig. 3 16 mm Ø
- CM24-240 Fig. 4 18 mm Ø
- CM24-241 Fig. 5 20 mm Ø
- CM24-242 Fig. 6 22 mm Ø
- CM24-243 Fig. 7 24 mm Ø
- CM24-244 Fig. 8 26 mm Ø
- CM24-245 Fig. 9 28 mm Ø
- CM24-246 Fig. 10 30 mm Ø



- CM24-247 10 mm Ø
- CM24-248 12 mm Ø
- CM24-249 14 mm Ø
- CM24-250 16 mm Ø
- CM24-251 18 mm Ø

MICHEL
CM24-247 - 251
moveable mirror
250 mm - 9 3/4"

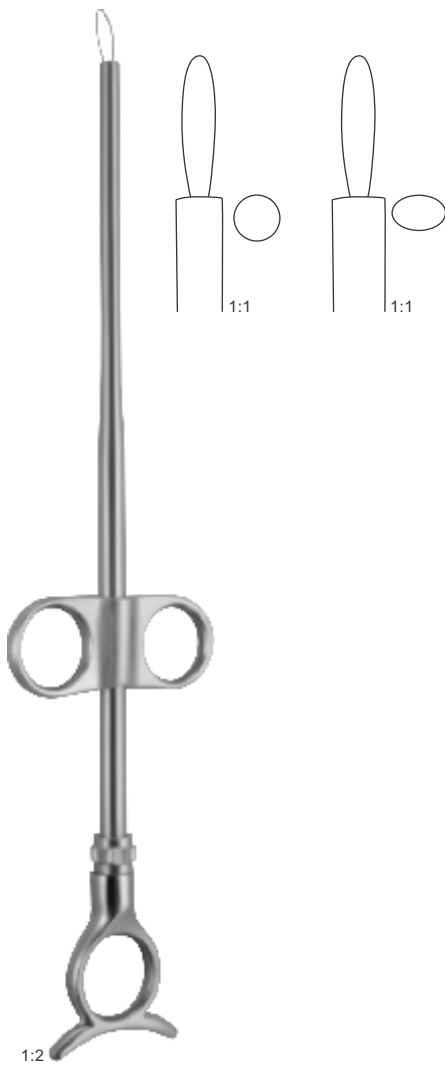

EVES
CM24-252
 280 mm - 11"



EVES
CM24-253
 280 mm - 11"



BRUENINGS
CM24-254
 280 mm - 11"



CM24-255
 10 mm - 33 ft.
 0.3 mm Ø
 0.4 mm Ø

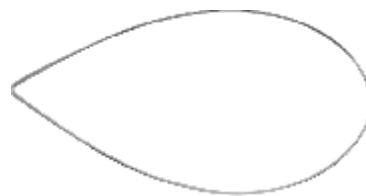

CM24-256
 Package of 100 pieces
 40 mm
 50 mm



1:2
COLVER
CM24-257
straight curved
190 mm - 7½"



1:2
WHITE
CM24-258
180 mm - 7"
230 mm - 9"

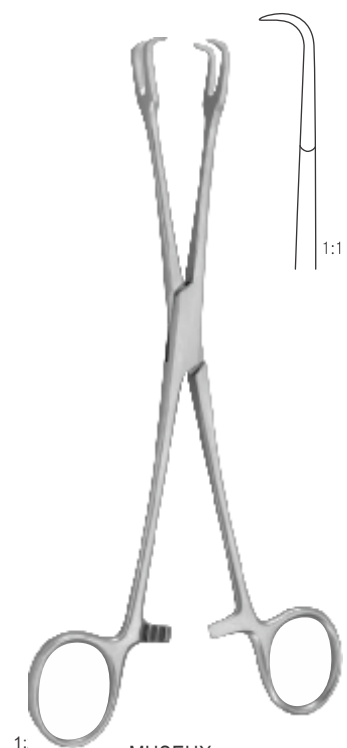

1:
MUSEUX
CM24-259
tonsil holding forceps
200 mm - 8"



1:2
JACKSON
CM24-260
laryngeal forceps
220 mm - 8½"

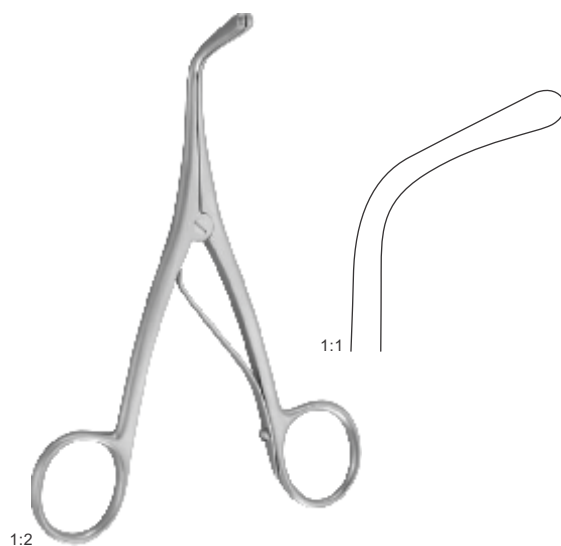

1:2
TROUSSEAU
CM24-261
140 mm - 5½"

TRACHEA DILATOR

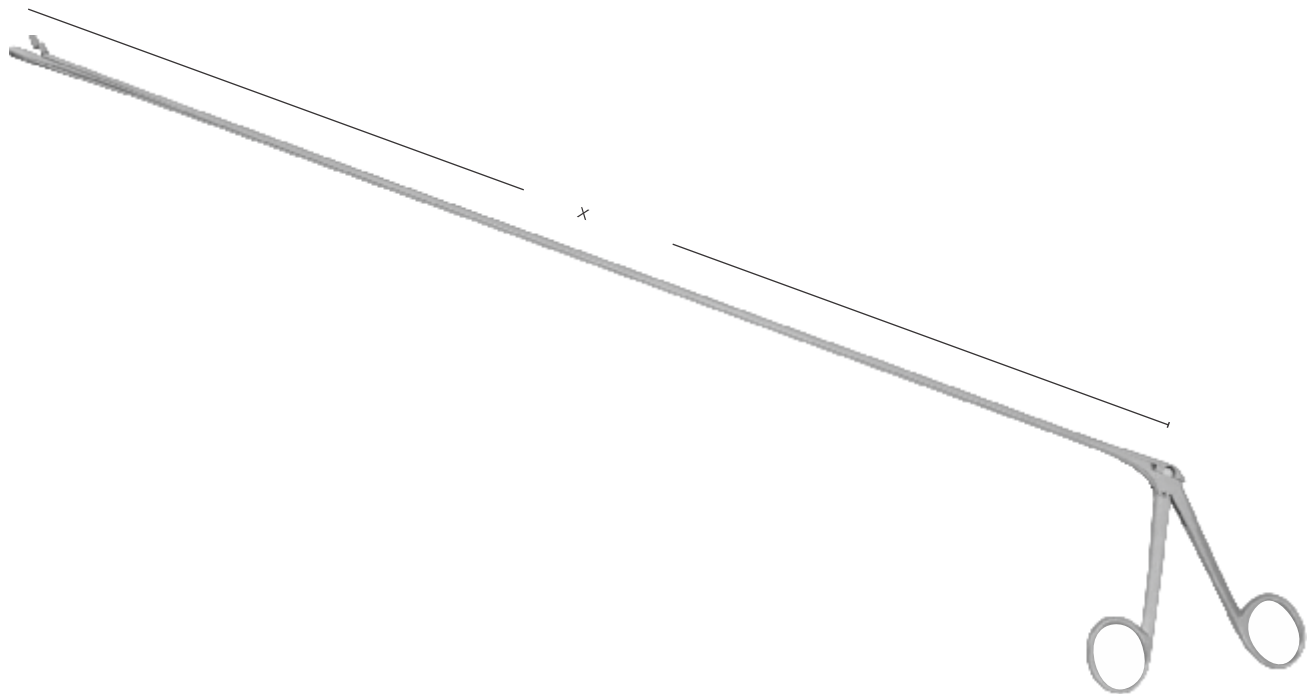

CM24-262



CM24-263



CM24-264



CM24-265



CM24-266



CM24-267



CM24-268

CHEVALIER - JACKSON
CM24-262 - 268
X = 300 mm - 12"
X = 400 mm - 16"
X = 500 mm - 20"
X = 600 mm - 23½"

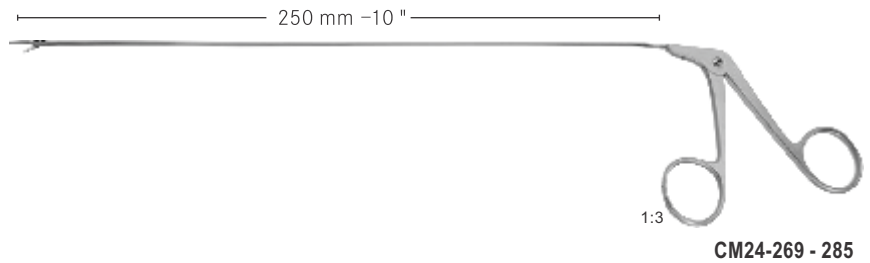

CM24-269
Straight



CM24-270
Straight horizontal



CM24-271
Angled up horizontal

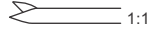

CM24-272
Curved right

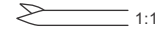

CM24-273
Curved left



CM24-274
Angled up



CM24-275
Straight, serrated



CM24-276
Straight horizontal



CM24-277
Angled up horizontal



CM24-278
Curved right



CM24-279
Curved left



CM24-280
Straight



CM24-281
Angled up
02.5 mm



CM24-282
Angled up horizontal



CM24-283
Curved right



CM24-284
Curved left

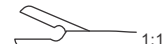

CM24-285
Oval
03.5 mm



DAVIS-BOYLE
CM24-286 - 288
complete, consisting of frame
and 5 tongue depressors no. 1-5

CM24-286
Frame for Mouth Gag

CM24-287
14.5 cm
Frame for Mouth Gag with joint

CM24-288
14.5 cm
Silicone inlay



1/2
Fig. 1
CM24-289 - 292
110 X 28 mm



Fig. 2
CM24-289
95 X 27 mm



Fig. 3
CM24-290
80 X 27 mm



Fig. 4
CM24-291
65 X 26 mm



Fig. 5
CM24-292
without suction tube
30 X 20 mm



NEUKAM
CM24-293 - 297
complete, with frame
and 3 tongue depressors

NEUKAM
CM24-293
Frame for Mouth Gag, only



KILNER-DOUGHTY
CM24-298 - 304
complete, with frame, 3 tongue depressors,
2 toothplates and 1 palate plate

KILNER-DOUGHTY
CM24-300
14.5 cm
Frame for Mouth Gag



CM24-299
Palate plate



CM24-294
Tongue Depressor
fenestrated blade for suction

Fig. 1
CM24-295

Fig. 2
CM24-296

Fig. 3
CM24-297

KILNER-DOUGHTY
CM24-301
Tongue Depressor
fenestrated blade for suction



Fig. 1
CM24-302
68 X 30 mm

Fig. 2
CM24-303
77 X 34 mm

Fig. 3
CM24-304
82 X 39 mm

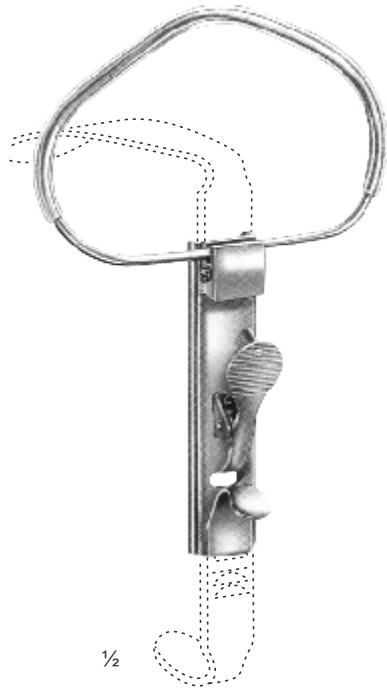

MCLVOR
CM24-305 - 309
 complete, with 3 tongue depressors

MCLVOR
CM24-305
 Frame for Mouth Gag



MCLVOR
CM24-306
 Tongue Depressors

Fig. 1
CM24-307
 100 X 25 mm

Fig. 2
CM24-308
 85 X 25 mm

Fig. 3
CM24-309
 75 X 25 mm

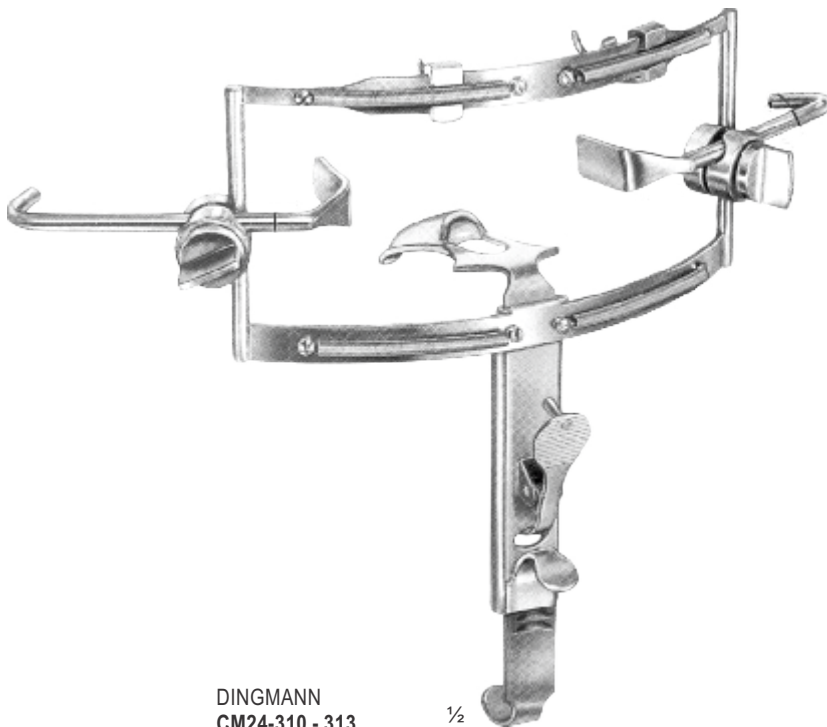

DINGMANN
CM24-310 - 313
 complete, with frame, 3 tongue depressors,
 and 2 adjustable lateral blades

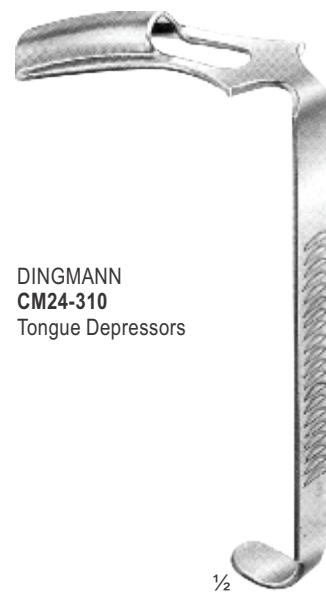

DINGMANN
CM24-310
 Tongue Depressors

Fig. 1
CM24-311
 62 X 26 mm

Fig. 2
CM24-312
 65 X 30 mm

Fig. 3
CM24-313
 78 X 32 mm



CM24-314
Fig.1
20 mm X 70 mm



CM24-315
Fig.2
30 mm X 80 mm



CM24-316
Fig.3
33 mm X 95 mm



CM24-317
Handle

NEGUS
CM24-314 - 317
complete
handle

TONSIL INSTRUMENTS

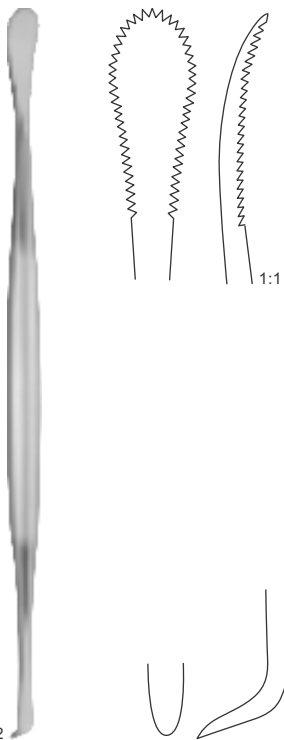

HENKE
CM24-318
tonsil dissector
230 mm - 9"

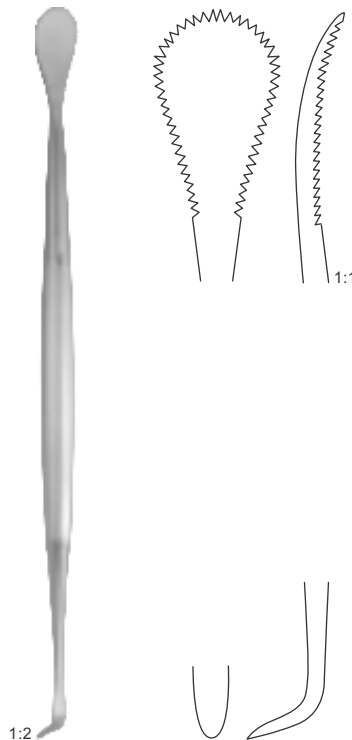

HENKE
CM24-319
tonsil dissector
230 mm - 9"



HURD
CM24-320
tonsil dissector
225 mm - 8 3/4"



JENNINGS
CM24-321 - 324
CM24-321 10.5 cm
CM24-322 12.5 cm
CM24-323 14.5 cm
CM24-324 16.5 cm

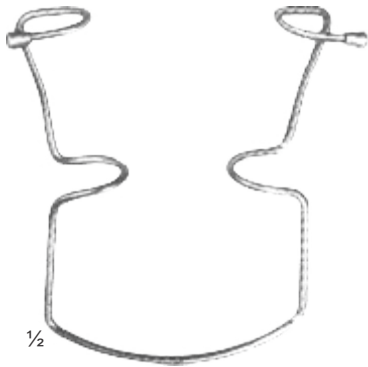

ORINGER
CM24-325 - 327
 9.5 cm
 self retaining, for children

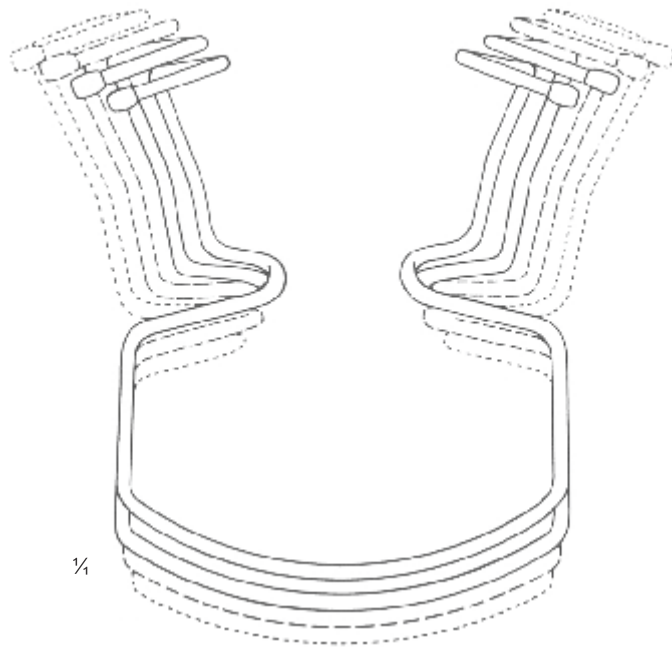
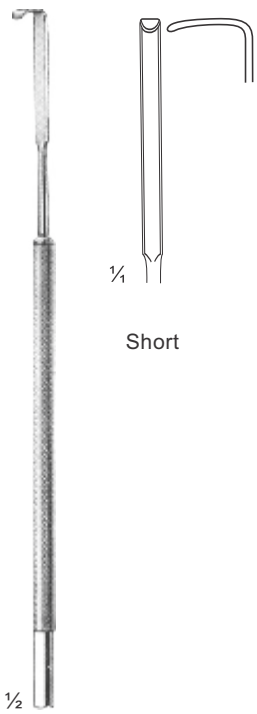

Fig. 1
CM24-325
 10 cm

Fig. 2
CM24-326
 10.5 cm

Fig. 3
CM24-327
 11 cm



Short

SALYER
CM24-328
185 mm
Cleft Palate
Hooklets

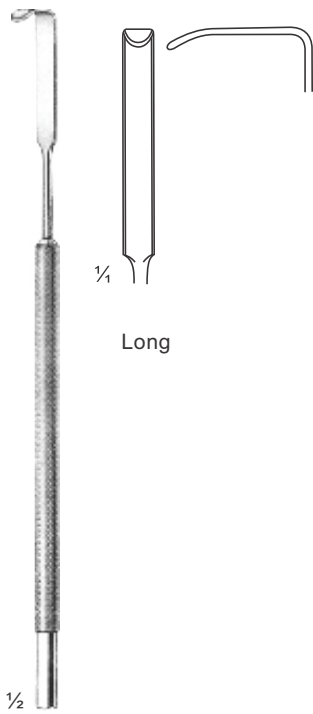

Long

SALYER
CM24-329
185 mm
Cleft Palate
Hooklet

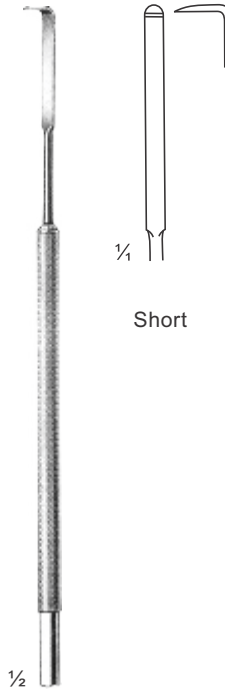

Short

SALYER
CM24-330
180 mm
Cleft Palate
Dissector

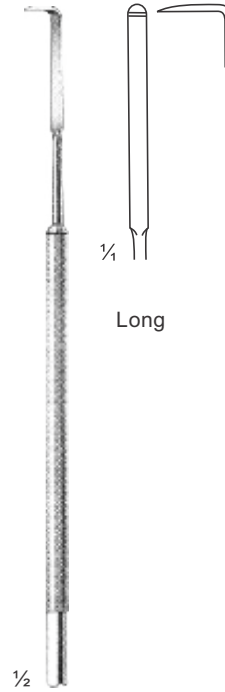

Long

SALYER
CM24-331
180 mm
Cleft Palate
Dissector

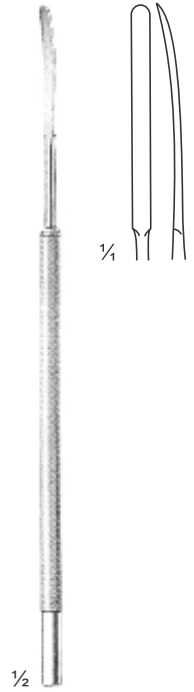

SALYER
CM24-332
180 mm
Cleft Palate
Instruments

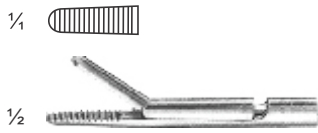

FRAENKEL
CM24-333
for interchangeable tubes

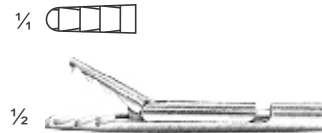

SEIFFERT
CM24-334
for interchangeable tubes

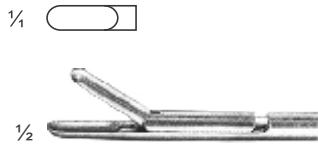

FRAENKEL
CM24-335
for interchangeable tubes

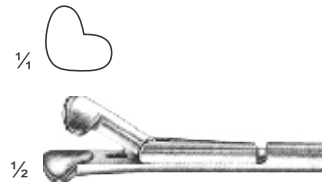

SCHEINMANN
CM24-336
for interchangeable tubes

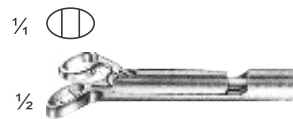

SCHEINMANN
CM24-337
for interchangeable tubes



BRÜNING'S
CM24-338 - 339
for interchangeable tubes

Fig. 2
CM24-338

Fig. 3
CM24-339

Fig. 2
CM24-340

Fig. 3
CM24-341



BRÜNING'S
CM24-340 - 341
for interchangeable tubes



LANGE
CM24-342
for interchangeable tubes

Fig. 1
CM24-342



Fig. 1
CM24-343



Fig. 2
CM24-344



KRAUSE
CM24-343 - CM24-344
for interchangeable tubes



KRAUSE
CM24-345
for interchangeable tubes



Fig. 1
CM24-346



Fig. 2
CM24-347



Fig. 3
CM24-348



Fig. 4
CM24-349



CORDES
CM24-346 - 349
for interchangeable tubes



SCHUMACHER
CM24-350
for interchangeable tubes



Fig. 1
CM24-351



Fig. 2
CM24-352



CORDES
CM24-351 - CM24-352
for interchangeable tubes



CORDES
CM24-353
for interchangeable tubes



ROSENBERG
CM24-354
for interchangeable tubes



CARE MEDICAL[®]
S U P P L I E S

Your health _ Our Priority

Section

25

Page 534-550

- Micro Scissors“spring Type”flat Handles
- Micro Scissors“spring Type”bayonet Shape
- Micro Spring Scissors
- Micro Eye Spring Scissors
- Scissors And Micro Forceps
- Delicate Tissue Forceps
- Micro Eye Forceps
- Micro Hooks, Sharp Instruments And Eye Retractor
- Lachrymal Probes And Eye Specula
- Self Retaining Retractors
- Needle Holders For Micro Surgery
- Micro Needle Holders With Round Handles

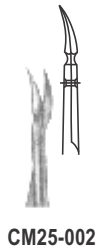
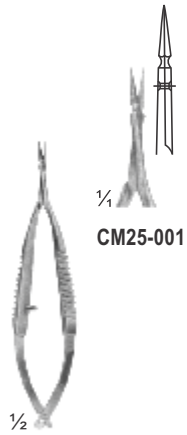

CM25-001

CM25-002

CM25-003

CM25-001 - 003
VANNAS
85 mm



CM25-004

CM25-005

CM25-004 - 005
CASTROVIEJO
95 mm

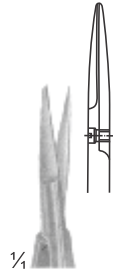

CM25-006
NOYES
125 mm

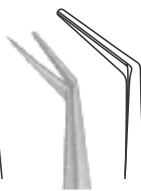

CM25-007

CM25-008

CM25-007 - 008
WECKER
Eye Scissor
110 mm

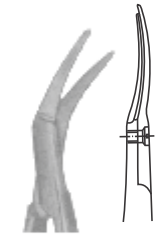
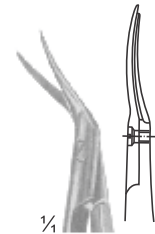
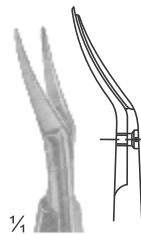

CM25-010

CM25-011

CM25-009
CASTROVIEJO
Eye Scissor
115 mm

CM25-010 - 011
CASTROVIEJO
Eye Scissor
110 mm

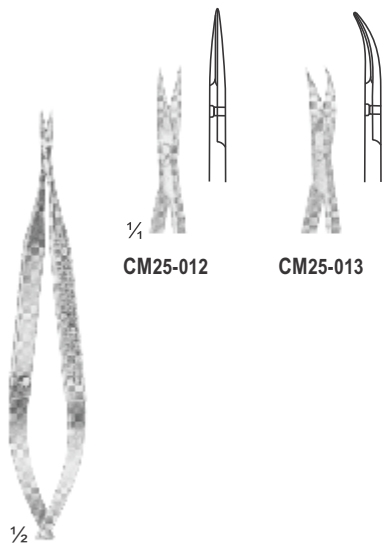

CM25-012 - 013
120 mm

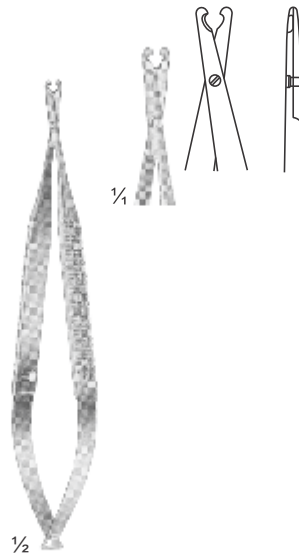

CM25-014
BIEMER
Vein Scissor
130 mm

CM25-015
160 mm

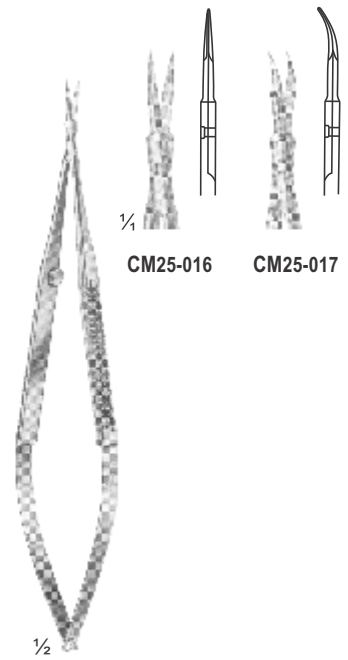

CM25-016

CM25-017

CM25-016 - 017
VANNAS
160 mm

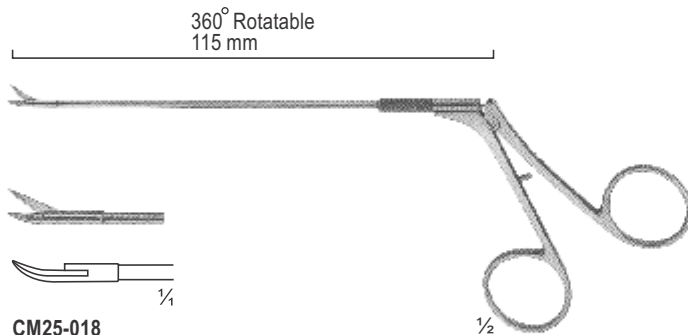

CM25-018
CASPAR
Micro Scissor Curved
115 mm

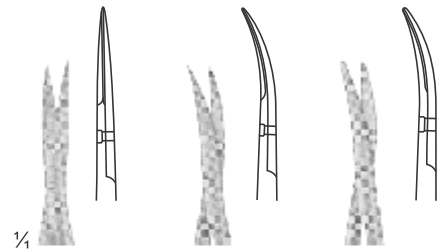

CM25-019

CM25-020

CM25-021



CM25-019 - 021
Micro Dissecting Scissor
145 mm

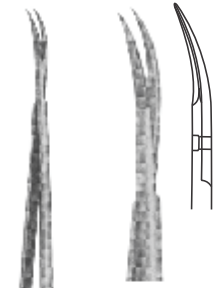

1/2
CM25-022
YASARGIL
245 mm

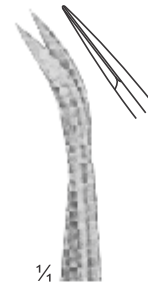

1/4
CM25-023

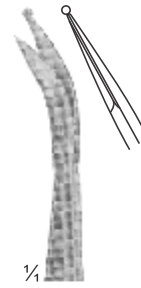

1/4
CM25-024



1/2
CM25-023 - 024
Laterally Angled
200 mm

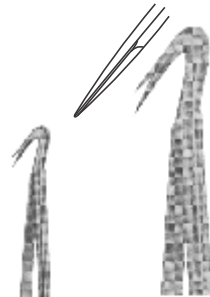

1/2
CM25-025
Laterally Angled
190 mm

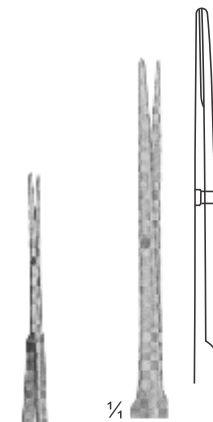

1/4
CM25-026

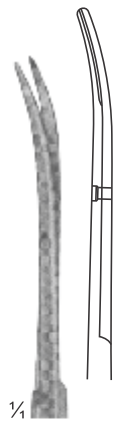

1/4
CM25-027



1/2
CM25-026 - 027
YASARGIL
225 mm

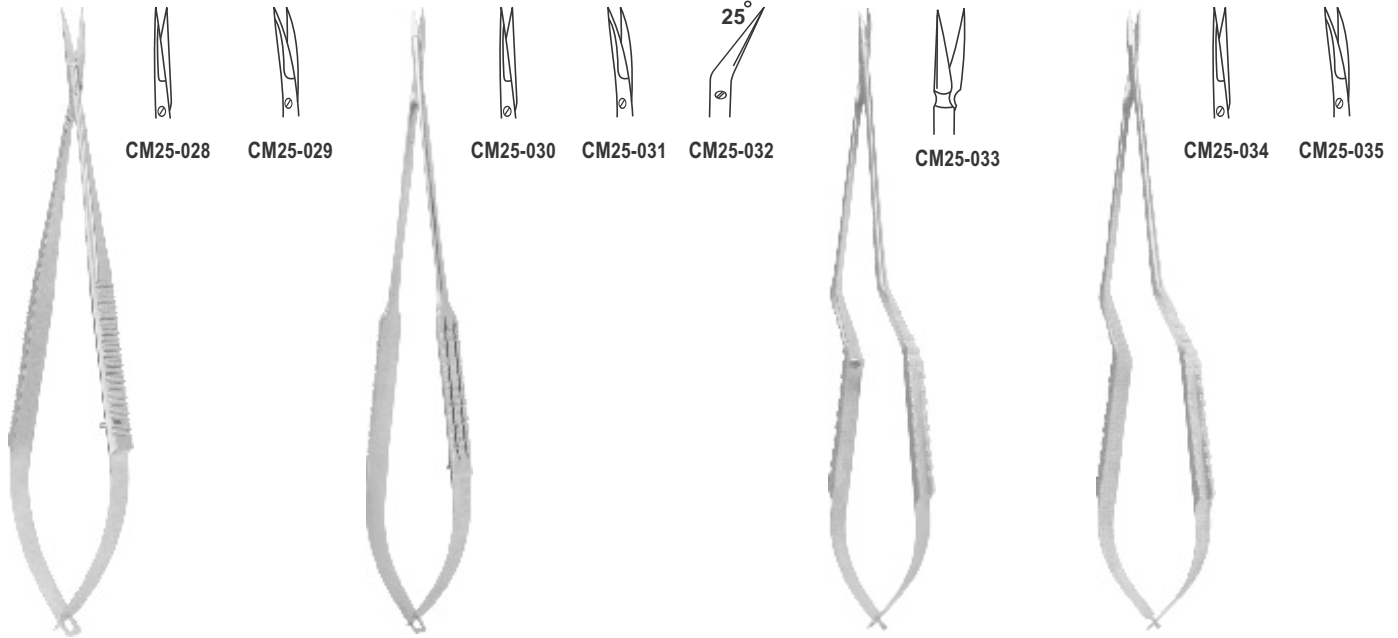

CM25-028 - 029
CASTROVIEJO
 Spring Scissors
 15, 18 cm

CM25-030 - 032
STREAMLINE
 Micro Coronary
 Scissors
 15, 18, 21, 23 cm

CM25-033
STREAMLINE
 Spring Scissors
 23 cm

CM25-034 - 035
STREAMLINE
 Spring Scissors
 23 cm

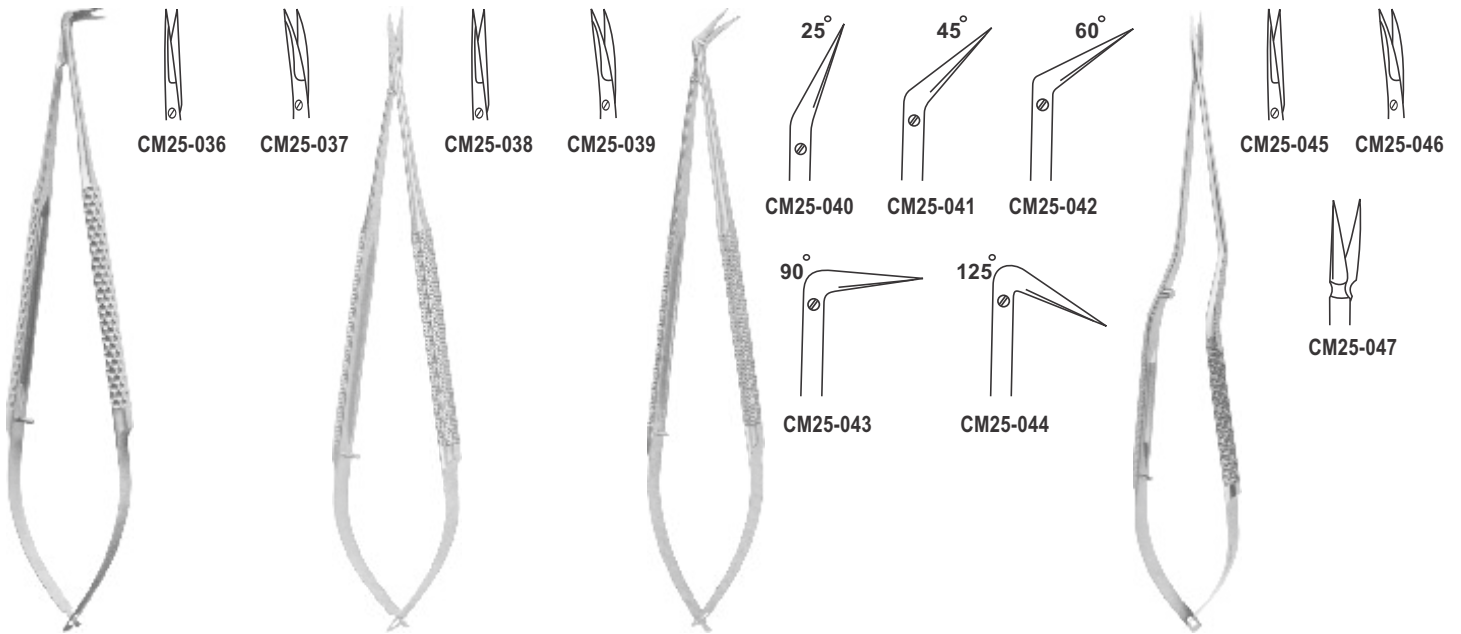

CM25-036 - 037
TOLEDO
 Spring Scissors
 16.5 cm

CM25-038 - 039
BARRAQUER
 Spring Scissors
 12, 15, 18 cm

CM25-040 - 044
BARRAQUER
 Spring Scissors
 18 cm

CM25-045 - 047
BARRAQUER
 Spring Scissors
 Bayonet
 22 cm

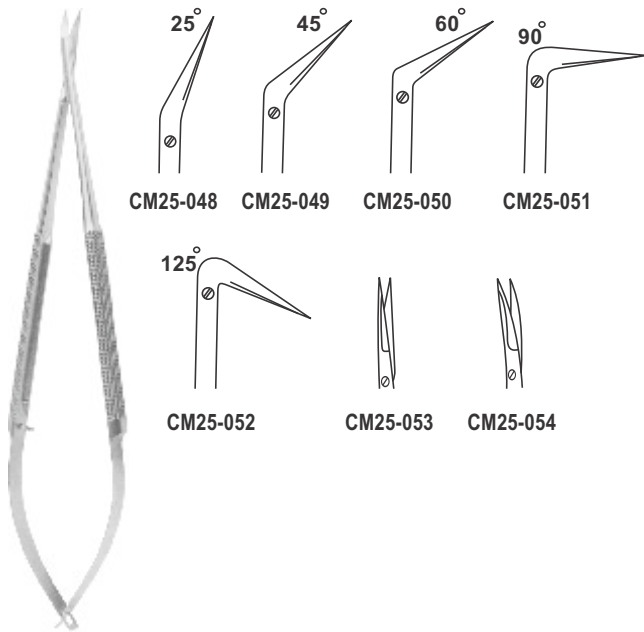

CM25-048 - 054
STREAMLINE
Spring Scissors
18, 21 cm



CM25-055
ONG-TREUMER
Capsulotomy Scissors
8 cm



CM25-056
VANNAS-TUBINGEN
After-Cataract Scissors
8 cm
8 mm



CM25-057
WESTCOTT
Tenotomy Scissors
11 cm



CM25-058
WESTCOTT
Micro-Tenotomy
Scissors
10.5 cm



CM25-059
Micro Spring
Scissors
10.5 cm
12 mm



CM25-060
CASTROVIEJO
Corneal Scissors
10.5 cm



CM25-061
TROUTMAN
Corneal Scissors
10 cm



CM25-062
BONN
 Eye Scissors
 9 cm



CM25-063
 Eye Scissors
 10.6 cm

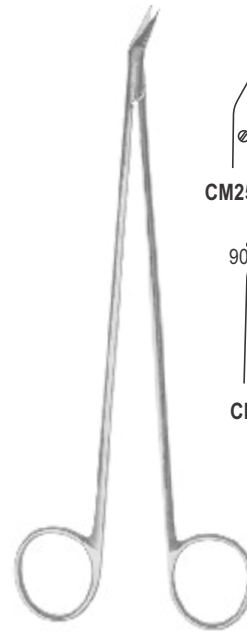

CM25-064 - 068
HEGEMANN
 Ring Scissors
 18 cm

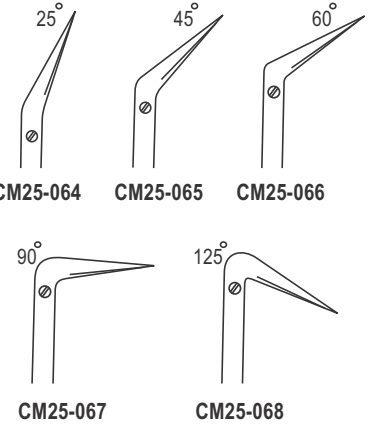

CM25-069 - 073
TOLEDO
 Forceps Heavy
 18, 21 cm

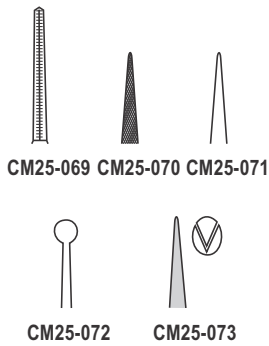

CM25-074 - 078
 Forceps
 15, 18 cm

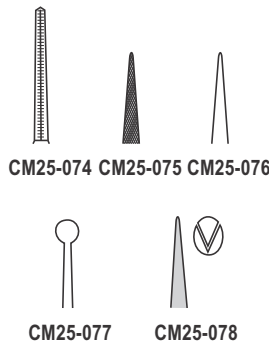

CM25-079 - 083
TOLEDO
 Forceps
 18, 21 cm

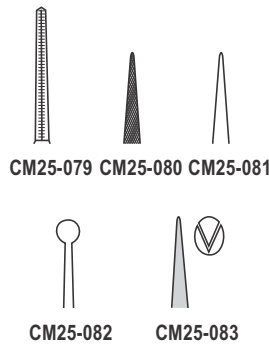

CM25-084 - 088
 15, 18, 21 cm

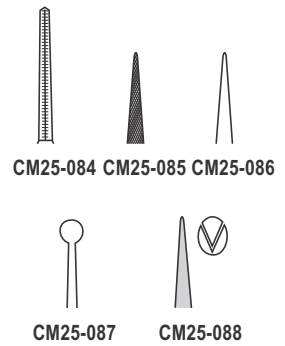

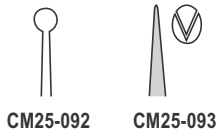
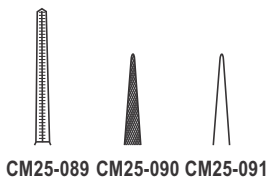

CM25-089 -093
Forceps
15, 18, 21 cm

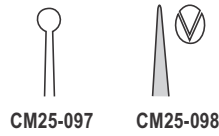
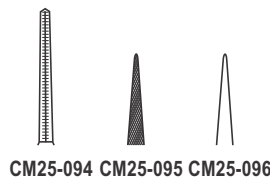

CM25-094 - 098
15, 18, 21 cm

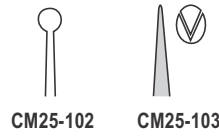
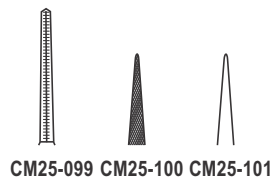

CM25-099 - 103
Forceps
15, 18, 21 cm

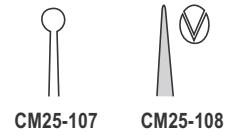
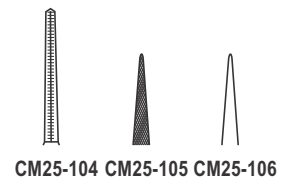

CM25-104 - 108
Forceps
15, 18, 21 cm

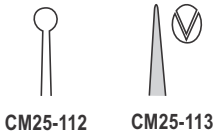
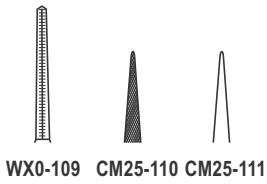

CM25-109 - 113
Forceps Counter
Balance
15, 18, 21 cm

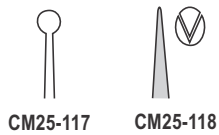
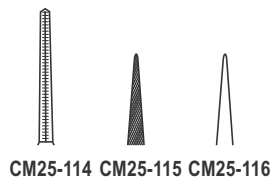

CM25-114 - 118
Forceps Counter
Balance
15, 18, 21,
23, 25 cm

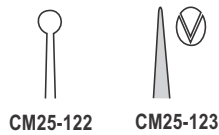
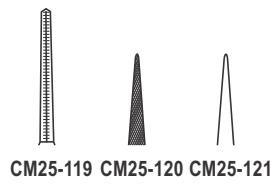

CM25-119 - 123
Forceps
15, 21, 23 cm

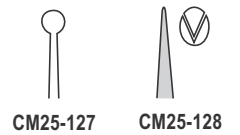
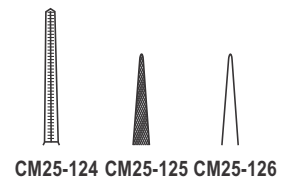

CM25-124 - 128
Forceps
18, 21 cm

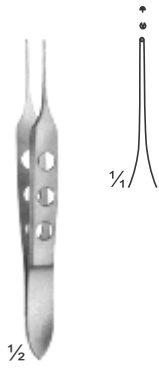

BISHOP-HARMON
CM25-129
8.5 cm

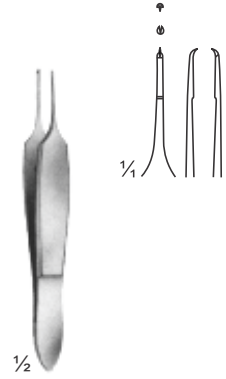

ST.MARTIN
CM25-130
8 cm

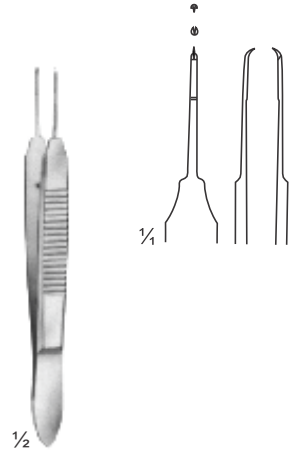

CASTROVIEJO
CM25-131
teeth 0.9 mm
10 cm

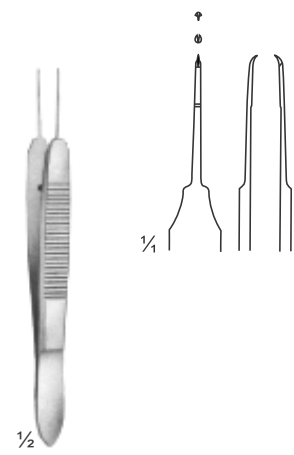

CASTROVIEJO
CM25-132
teeth 0.5 mm
10 cm

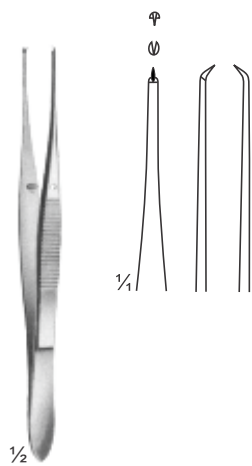

ELSCHING
CM25-133
11 cm

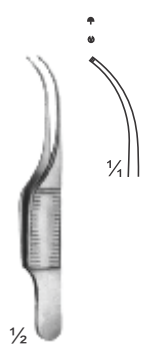

GILL
CM25-134
7.5 cm

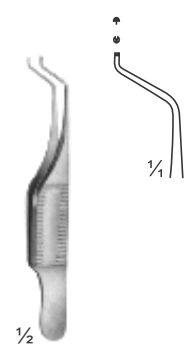

GILL - HESS
CM25-135
7.5 cm

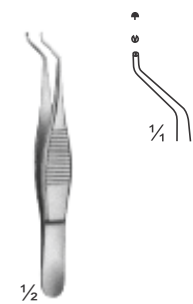

HESS
CM25-136
7 cm

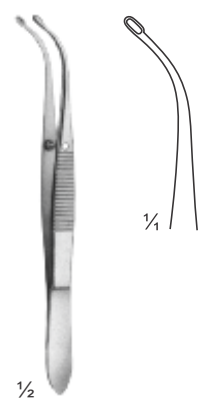

ARRUGA
CM25-137
10 cm

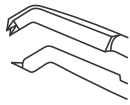

CM25-138

CM25-138
Colibri Forceps With
Tying Platform
8 cm



CM25-139
Utility Forceps
10 cm

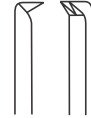

CM25-140

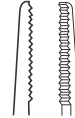

CM25-141

CM25-140 - 141
TUBINGEN
Suture Forceps
8.5, 11 cm



CM25-142
BONN
Suture Forceps
7.5 cm



CM25-143
BONN
Iris Forceps
8 cm



CM25-144
McDonalds-Spaleck
Lense Implantation
Forceps Crossaction
10 cm
5, 6 mm



CM25-145
FAULKNER
Holding Forceps
10 cm
5, 6, 11 mm



CM25-146
Spaleck-microma
Lense Implantation
Forceps
10 cm
5.6, 6.6 mm



CM25-147
Hook



CM25-148
JAMESON
Strabismus Hook



CM25-149
GRAEFE
Strabismus Hook
13, 14 cm



CM25-150
GRAEFE
Iris Hook



CM25-151
GILLES
Skin Hook



CM25-152
GUTHRIE
Fixation Hook,
double



CM25-153
MEYHOFER
Spoon



CM25-154
KUHNT
Corneal Scarifier



CM25-155
GRAEFE
Scarifier



CM25-156
Foreign Body
Needle



CM25-157
HAMBURG
Air Keratome



CM25-158
DESMARRES
Eye Retractor



CM25-159
BOWMAN
Lachrymal
Probes



CM25-160
WILDER
Lachrymal
Probes



CM25-161
WEISS
Eye Speculum



CM25-162
CASTROVIEJO
Eye Speculum

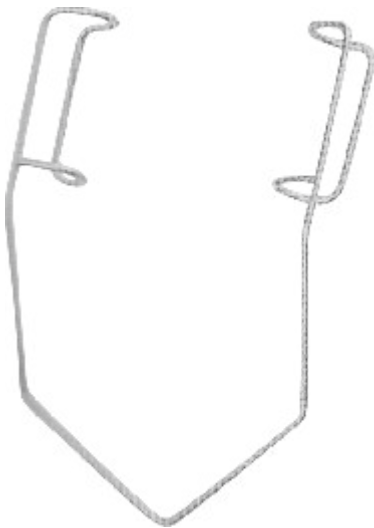

CM25-163
BARRAQUER
Eye Speculum

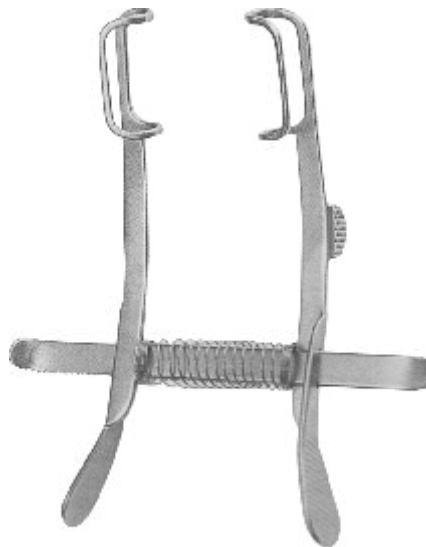

CM25-164
MELLINGER
Eye Speculum



CM25-165
MINIGOLDSTEIN
Self-Retaining Retractors
3 Teeth
2 cm



CM25-166
ALM
Self-Retaining Retractors
4 Teeth
7 cm



CM25-167
ALM
Self-Retaining Retractors
4 Teeth
10 cm



CM25-168
HOLTZHEIMER
Self-Retaining Retractors
4 Teeth
10 cm



CM25-169
HOLTZHEIMER
Self-Retaining Retractors
4 Teeth
10 cm



CM25-170
Cross Action
Forceps
28 mm



CM25-171
Cross Action
Forceps
35 mm

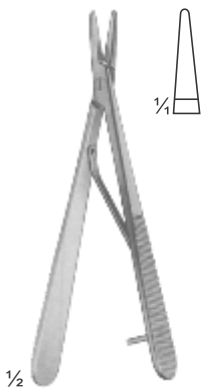

CM25-172
ROHRSCHEIDER
With copper inserts
100 mm



CM25-173
KALT
With catch
135 mm



CM25-174
ARRUGA
With catch
135 mm



CM25-175 - 176
CASTROVIEJO
With catch
145 mm



CM25-177 - 178
CASTROVIEJO
Without Catch
160 mm



CM25-179 CM25-180

CM25-179 - 180
Without catch
185 mm



CM25-181 Without catch
CM25-182 With catch

CM25-181 - 182
JACOBSON
185 mm



CM25-183
Without catch
195 mm

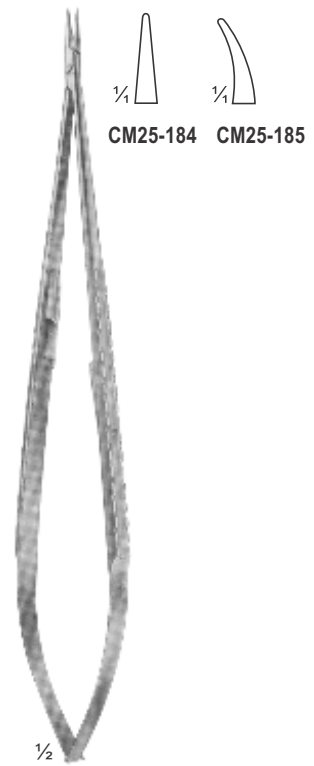

CM25-184 CM25-185

CM25-184 - 185
YASARGIL
With catch
200 mm



CM25-186
115 mm



CM25-187
135 mm

1/2

CM25-186 - 187
BARRAQUER
Without catch



CM25-188



CM25-189

1/2

CM25-188 - 189
BARRAQUER
Without catch
120 mm



CM25-190



CM25-191

1/2

CM25-190 - 191
BARRAQUER
Without catch
120 mm



CM25-192



CM25-193

1/2

CM25-192 - 193
BARRAQUER
Without Catch
150 mm

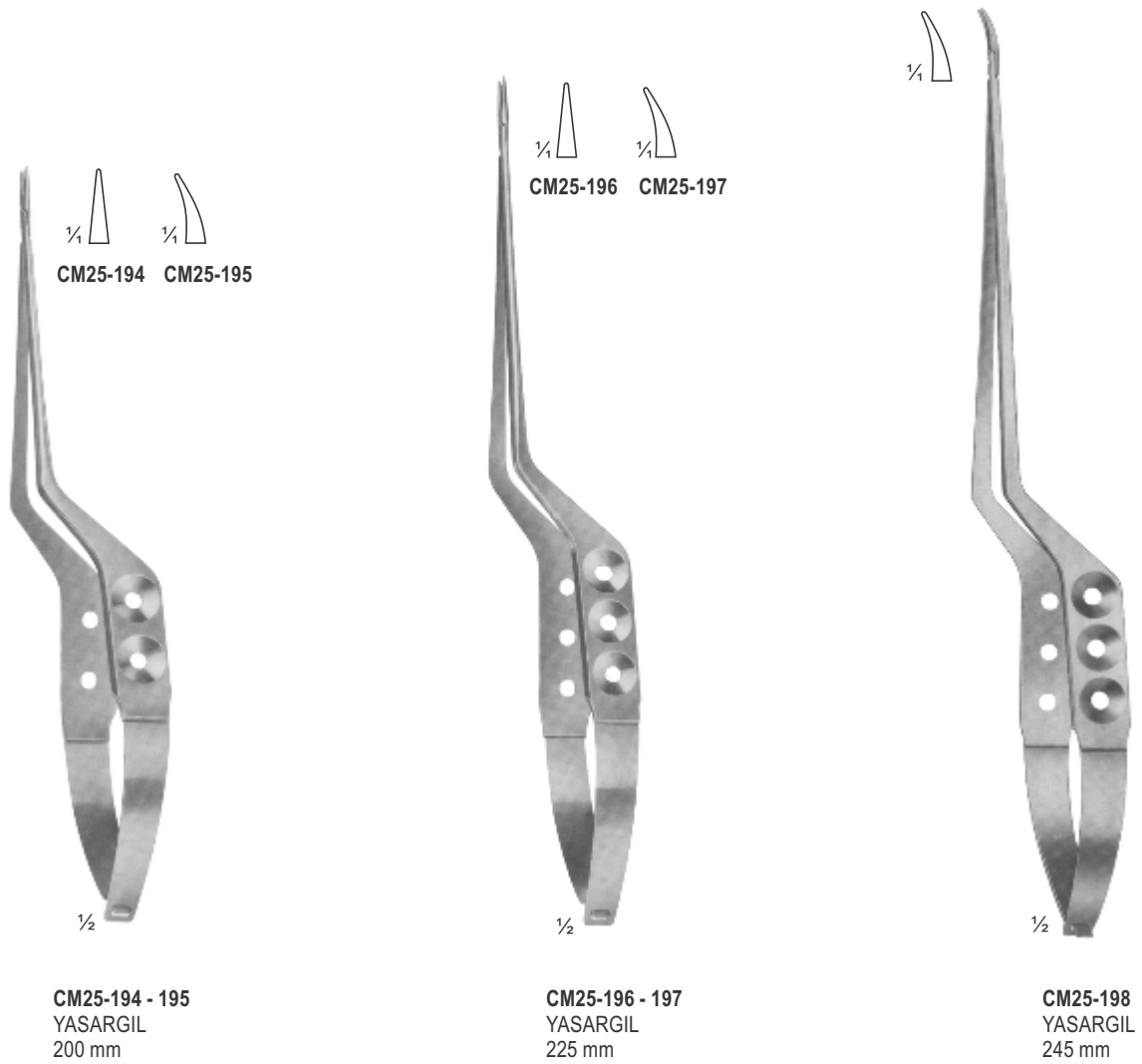



CM25-199



CM25-200



CM25-201



CM25-202

CASTROVIEJO
CM25-199 - 202
145 mm



CM25-203



CM25-204



CM25-205



CM25-206

CASTROVIEJO
CM25-203 - CM25-206
180 mm



CM25-207



CM25-208



CM25-209



CM25-210

BARRAQUER
CM25-207 - 210
145 mm



HEPP SCHEIDEL
CM25-211
180 mm



CARE MEDICAL[®]
SUPPLIES

Your health _ Our Priority

Section

26

Page 551-563

Vacuum Currettes For Aspiration Lipectomy
Suction Instruments
Combined Suction And Irrigation Cannula

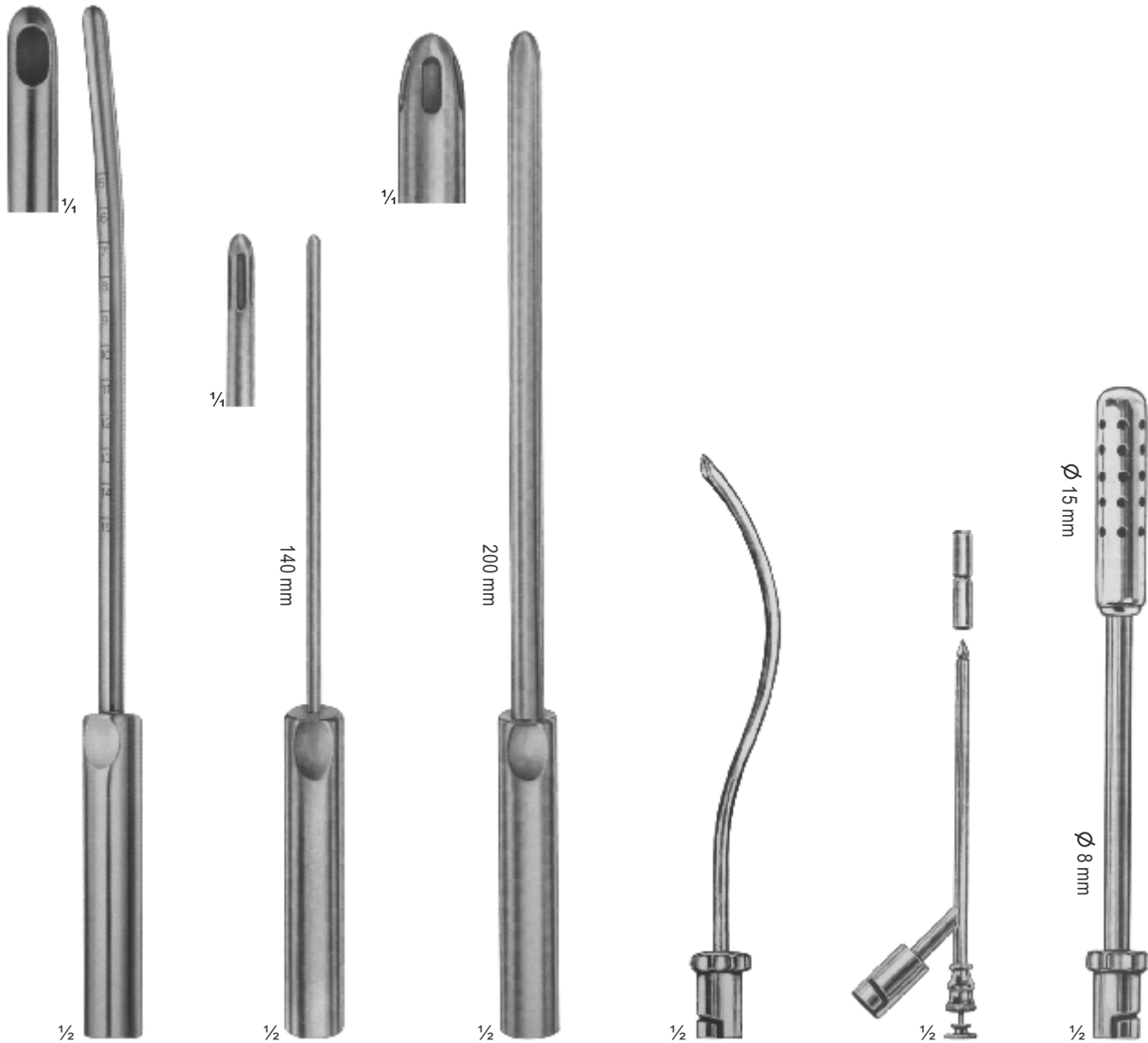

CM26-001 - 006
BIEMER
CM26-001 ∅ 4 mm
CM26-002 ∅ 6 mm
CM26-003 ∅ 8 mm
CM26-004 ∅ 10 mm
CM26-005 ∅ 12 mm
CM26-006 ∅ 14 mm
 Currettes for aspiration lipectomy, graduated, slightly curved

CM26-007 - 008
BIEMER
CM26-007 ∅ 4 mm
CM26-008 ∅ 6 mm
 Currettes for aspiration lipectomy, with three apertures, slightly curved malleable

CM26-009 - 011
BIEMER
CM26-009 ∅ 8 mm
CM26-010 ∅ 10 mm
CM26-011 ∅ 12 mm
 Currettes for aspiration lipectomy, with three apertures, slightly curved malleable

CM26-012
For aspirating fluid from the excretory ducts of large glands and for keeping the operating area clear 170 mm

CM26-013
Trocar
 For puncturing 150 mm

CM26-014
For clearing large quantities of fluid 190 mm



CM26-015
Trocar
For puncturing
170 mm

CM26-016
Hollow needle,
sharp
150 mm

CM26-017
double curved
For general
surgery
230 mm

CM26-018
For tonsillectomy,
oral and laryngeal
operations
190 mm

CM26-019
For tonsillectomy,
oral and laryngeal
operations
220 mm

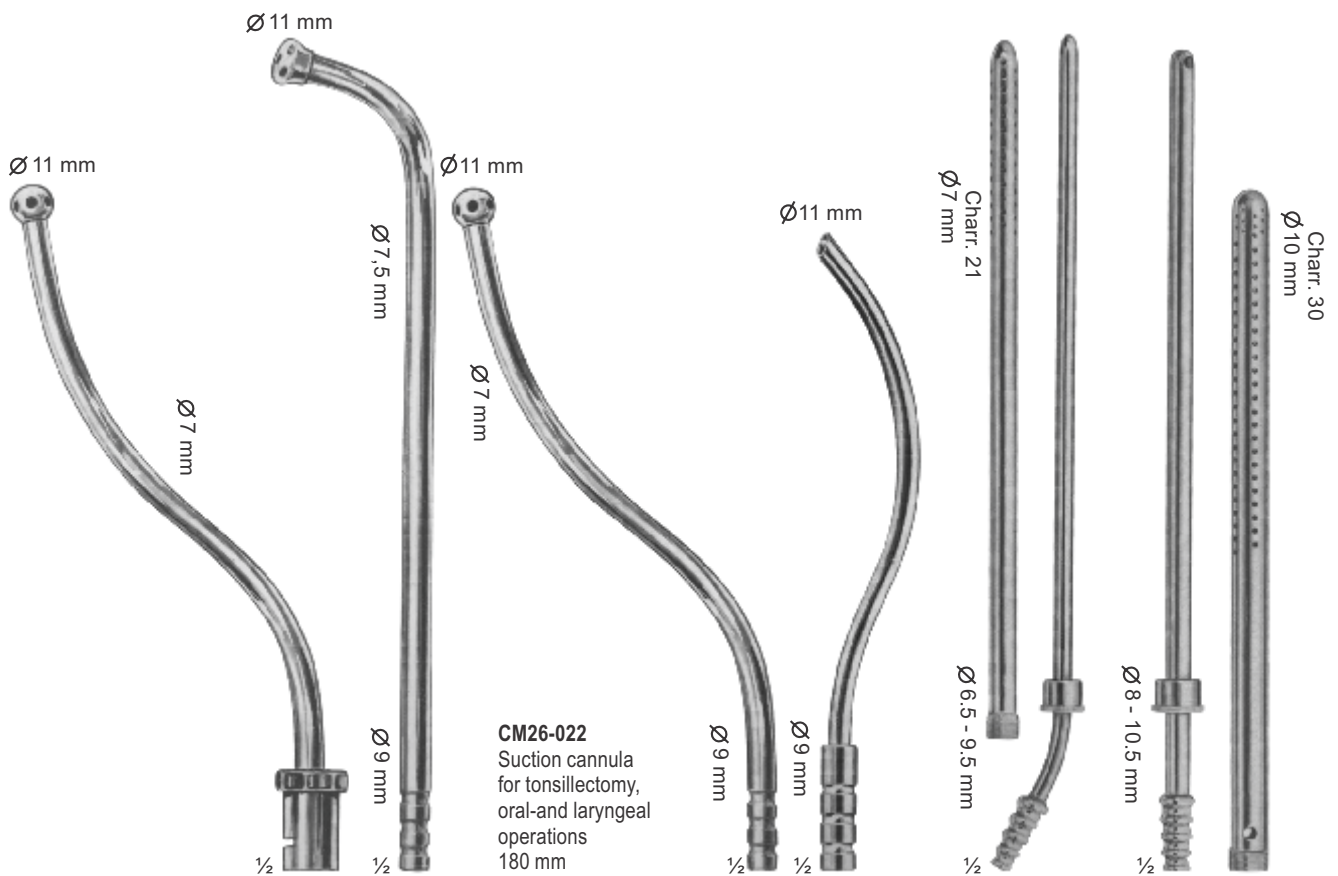

CM26-020
For tonsillectomy,
oral-and laryngeal
operations
180 mm

CM26-021
Suction cannula
for tonsillectomy,
oral-and laryngeal
operations
220 mm

CM26-022
Suction cannula
for tonsillectomy,
oral-and laryngeal
operations
180 mm

CM26-023
S-shaped blunt cannula
for aspirating fluid from
the excretory ducts of
large glands and for
keeping the operations
area clear
170 mm

CM26-024
POOL
Suction cannula,
with outer tube
to be screwed of
225 mm

CM26-025
POOL
Suction cannula,
with outer tube
to be screwed of
225 mm

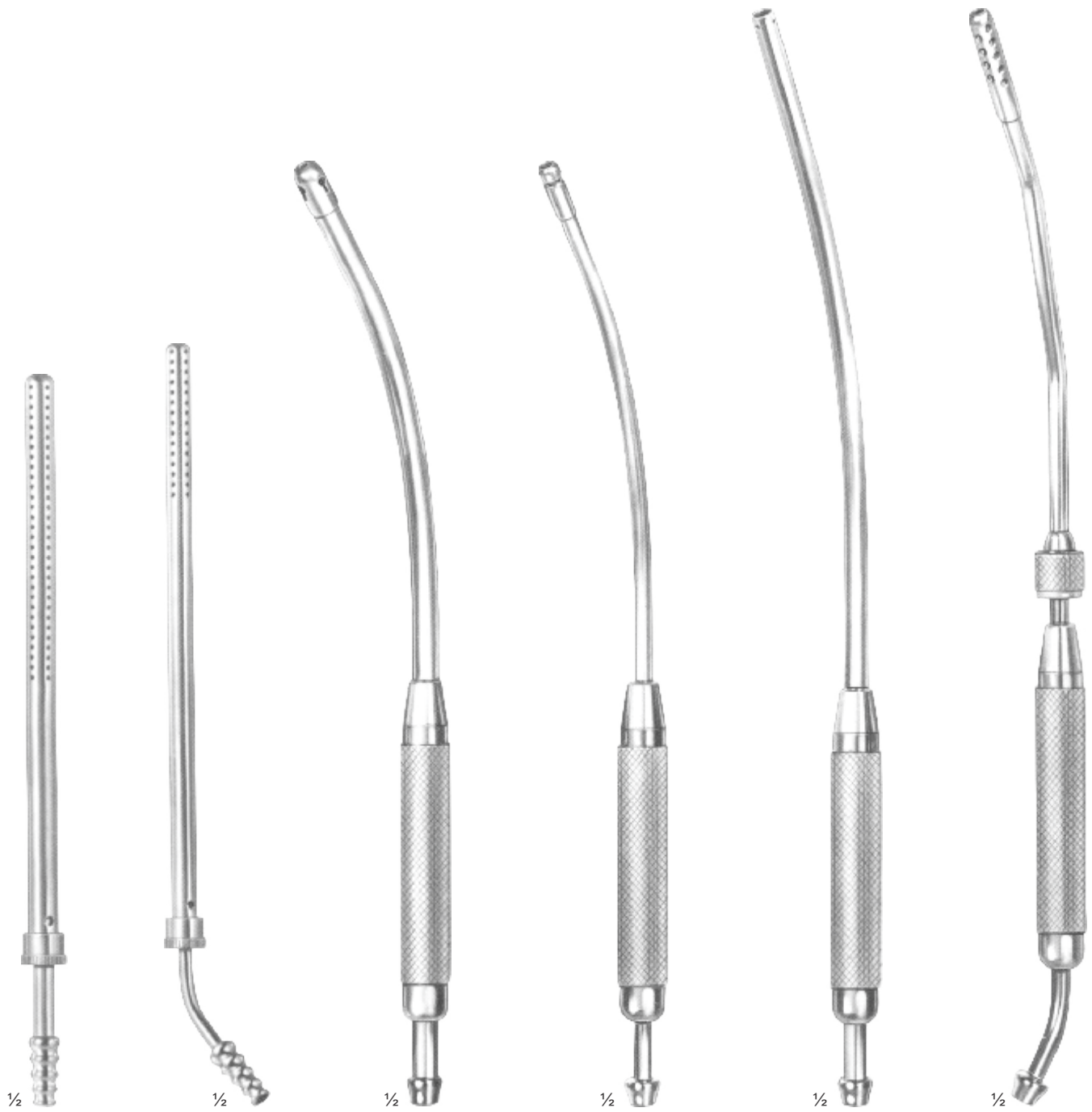

POOLE
CM26-026
24 cm
Ø10 mm

POOLE
CM26-027
25 cm
Ø 8 mm

COLLEY
CM26-028
with perforated screw tip
31 cm
Ø10 mm

COLLEY
CM26-029
with perforated screw tip
31 cm
Ø7 mm

COLLEY
CM26-030
36 cm
Ø 8 mm

COLLEY
CM26-031
with perforated
screw tip
36 cm
Ø 8 mm

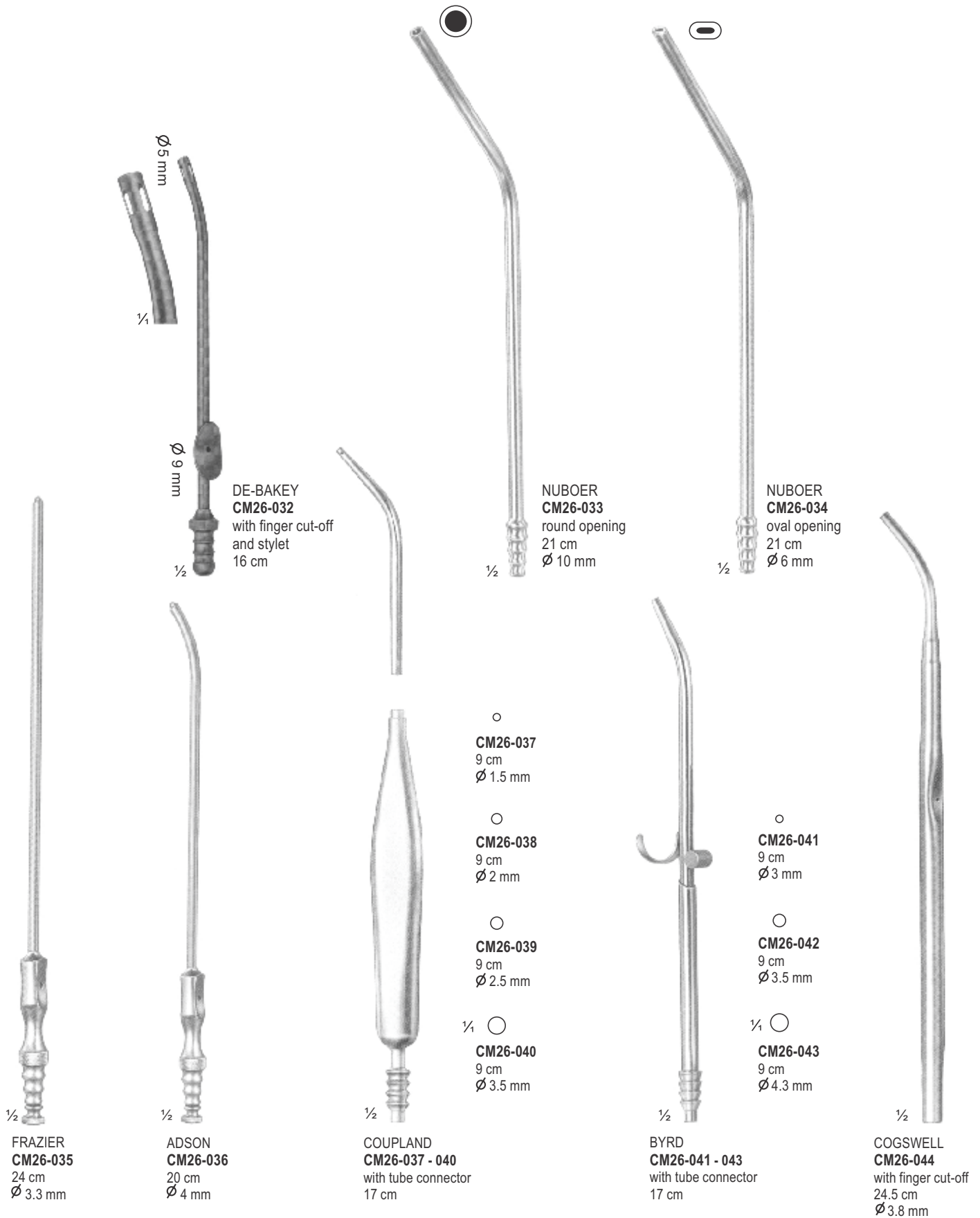

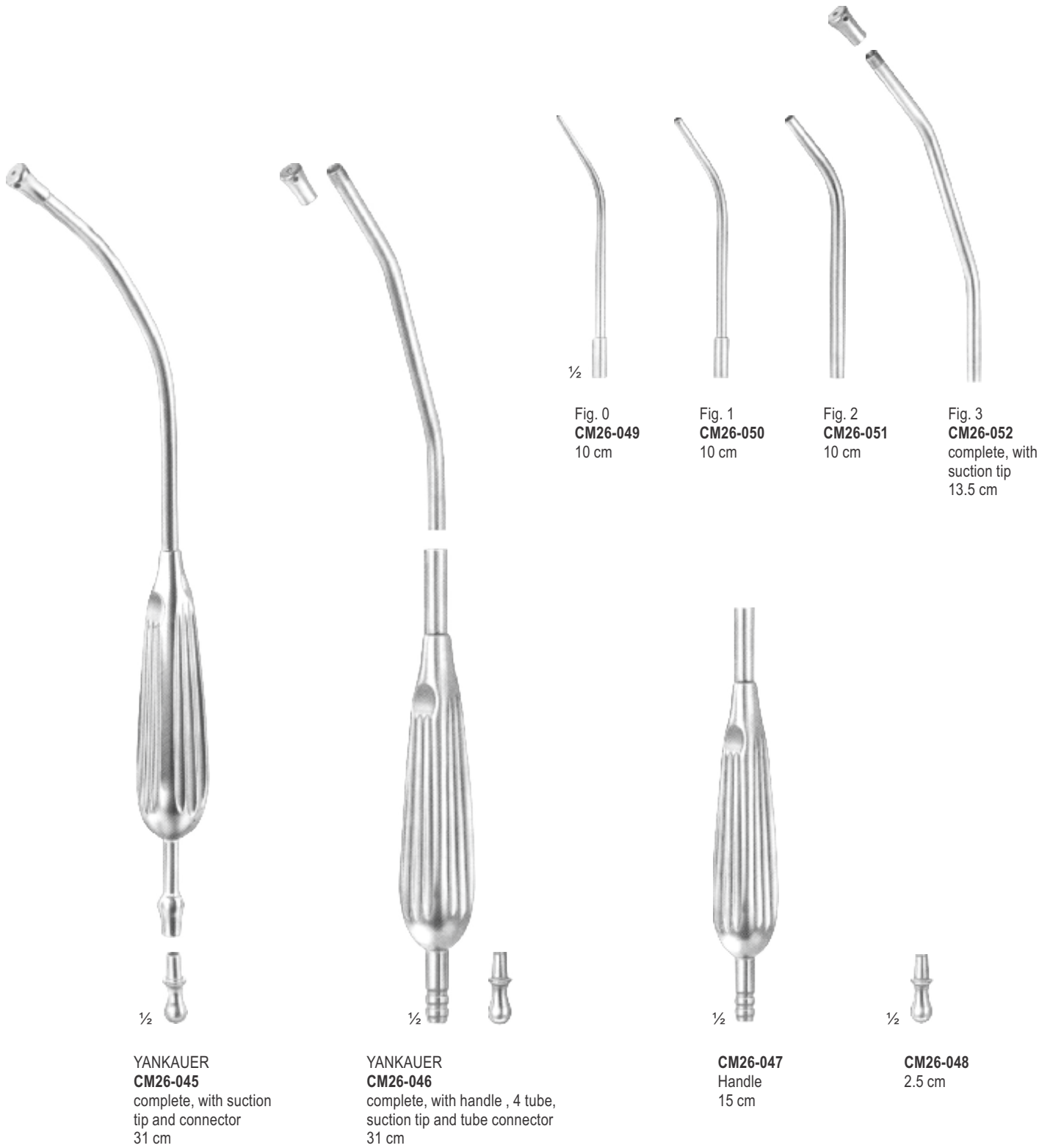

WULLSTEIN
CM26-053
 Suction tube, conical, silver, olive
 with LUER hub
 16 cm

Ø1,75 mm

Ø3 mm

1/2

Ø8 mm

WULLSTEIN
CM26-054 1.5 mm
CM26-055 2 mm
 Suction tube, cylindrical, silver, with
 stylet with LUER hub
 16 cm



1/2

Ø8 mm

Usable length

YASARGIL usable length diam.

CM26-056	13 cm	1.5 mm
CM26-057	15 cm	1.5 mm
CM26-058	18 cm	1.5 mm
CM26-059	22 cm	1.5 mm
CM26-060	13 cm	2 mm
CM26-061	15 cm	2 mm
CM26-062	18 cm	2 mm
CM26-063	22 cm	2 mm

YASARGIL usable length diam.

CM26-064	13 cm	2.5 mm
CM26-065	15 cm	2.5 mm
CM26-066	18 cm	2.5 mm
CM26-067	22 cm	2.5 mm
CM26-068	13 cm	3.5 mm
CM26-069	15 cm	3.5 mm
CM26-070	18 cm	3.5 mm
CM26-071	22 cm	3.5 mm

Ø6.5-9 mm
 with LUER hub

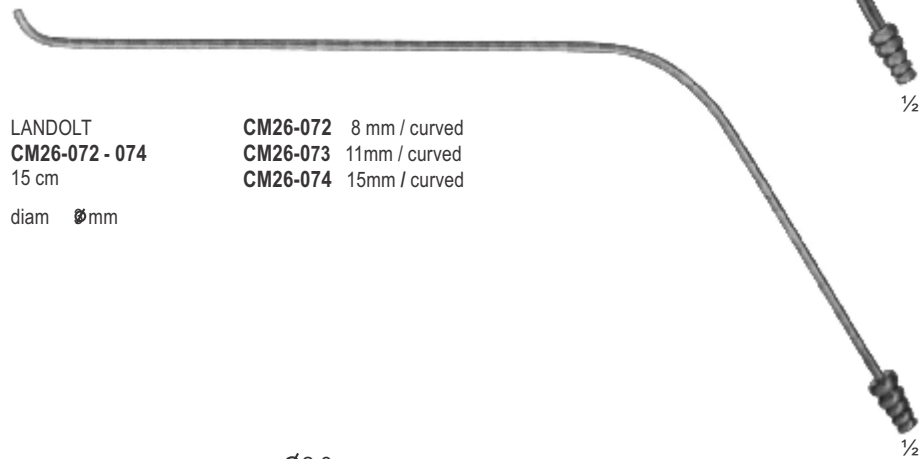

LANDOLT
CM26-072 - 074
 15 cm
 diam Ømm

CM26-072 8 mm / curved
CM26-073 11mm / curved
CM26-074 15mm / curved

1/2

1/2

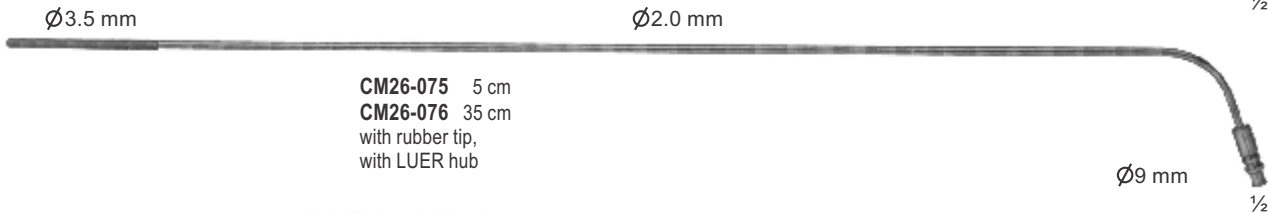

Ø3.5 mm

Ø2.0 mm

CM26-075 5 cm
CM26-076 35 cm
 with rubber tip,
 with LUER hub

Ø9 mm

1/2

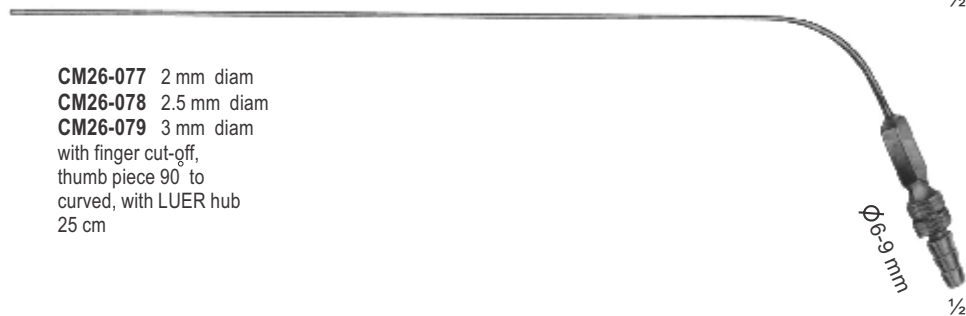

CM26-077 2 mm diam
CM26-078 2.5 mm diam
CM26-079 3 mm diam
 with finger cut-gff,
 thumb piece 90° to
 curved, with LUER hub
 25 cm

Ø6.9 mm

1/2

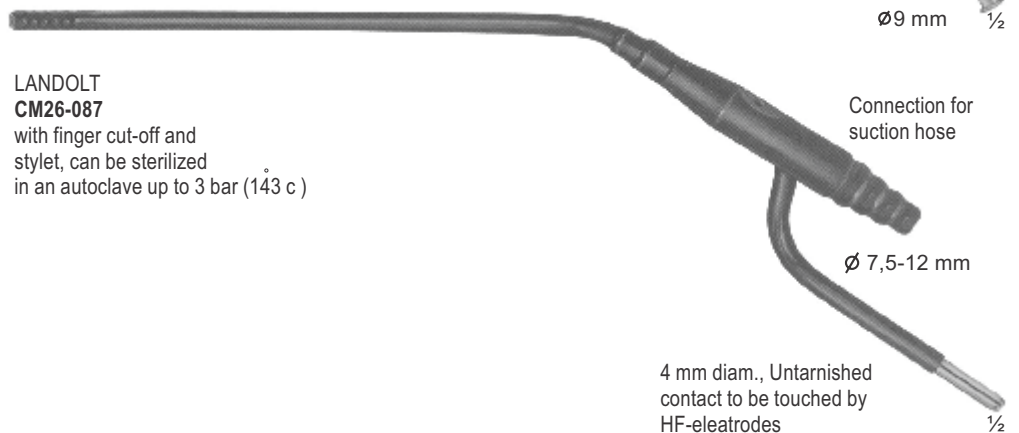
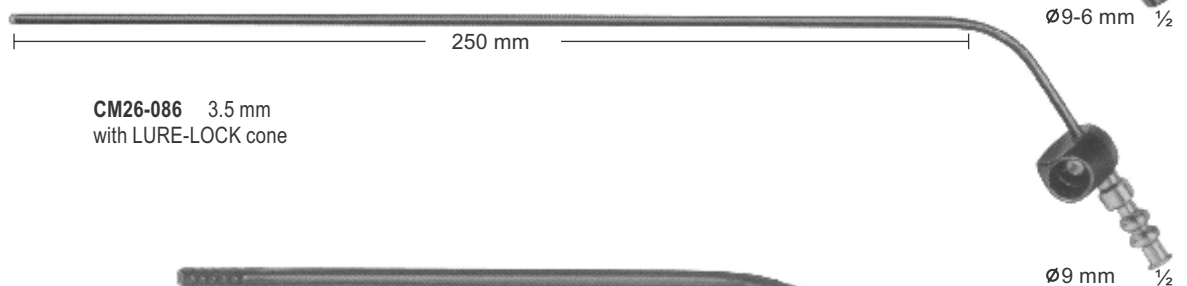
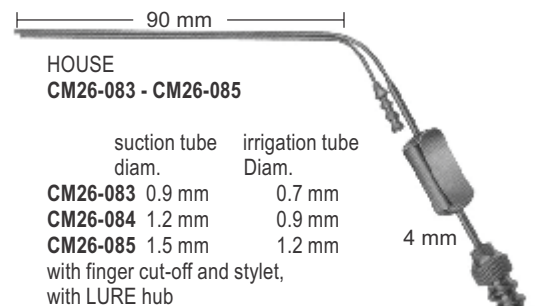
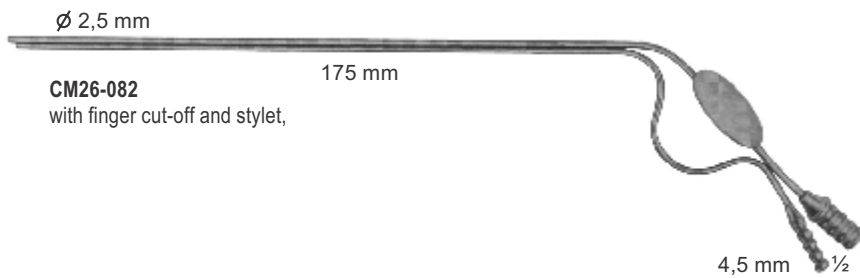
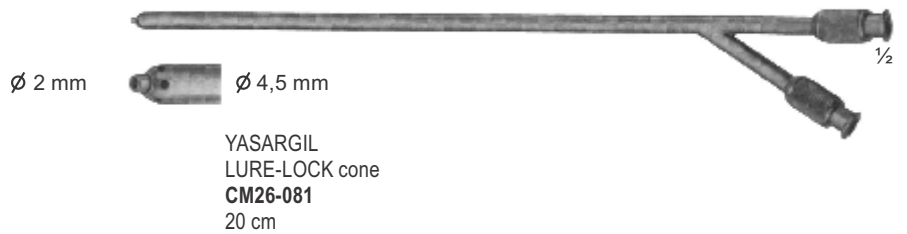
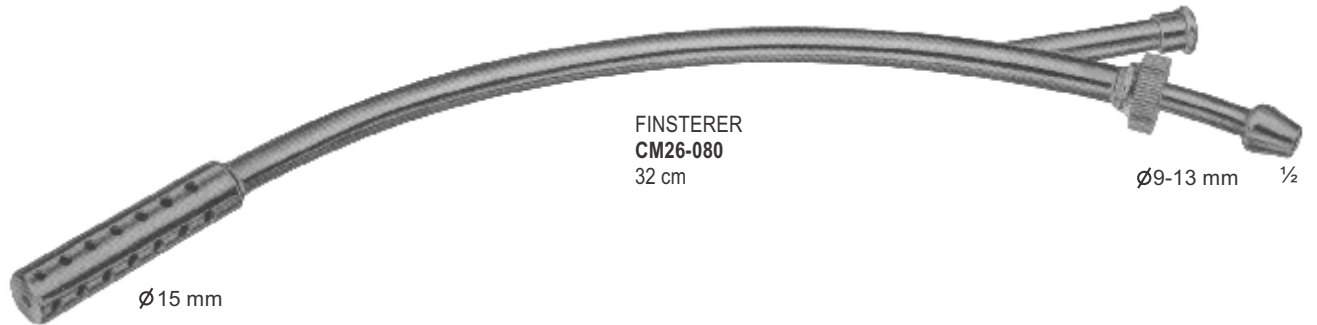



1/2

WULLSTEIN
CM26-088 - 090
14 cm
handle with tube, only



WULLSTEIN
CM26-088
4.5 cm
Mirco Suction Cannula
Complete, with handle and 3 tips
Ø 0.4 mm



WULLSTEIN
CM26-089
4.5 cm
Mirco Suction Cannula
Complete, with handle and 3 tips
Ø 0.6 mm



WULLSTEIN
CM26-090
4.5 cm
Mirco Suction Cannula
Complete, with handle and 3 tips
Ø 0.8 mm



CM26-091
working length 75 mm
Ø 1 mm



CM26-092
working length 75 mm
Ø 1.5 mm



CM26-093
working length 75 mm
Ø 2 mm



1/2

BARON-SCHUKNECHT
CM26-091 - 093
with finer cut-off



1/2

ZOELLNER
CM26-094 - 097
Suction Cannula

Suction Tip

CM26-094	0.5 mm
CM26-095	0.7 mm
CM26-096	0.9 mm
CM26-097	1.2 mm



LUER
CM26-098 - 100
 Conical

1/2

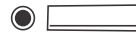

CM26-098
 16.5 cm
 Ø 3 mm
 working length
 110 mm

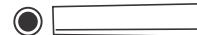

CM26-099
 16.5 cm
 Ø 3.5 mm
 working length
 110 mm



CM26-100
 18 cm
 Ø 4.5 mm
 working length
 130 mm



YASARGIL
CM26-101 - 104
 working length
 15 cm

1/2



CM26-101
 17 cm
 Ø 1.5 mm

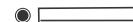

CM26-102
 17 cm
 Ø 2 mm



CM26-103
 17 cm
 Ø 2.5 mm

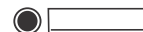

CM26-104
 17 cm
 Ø 3.5 mm

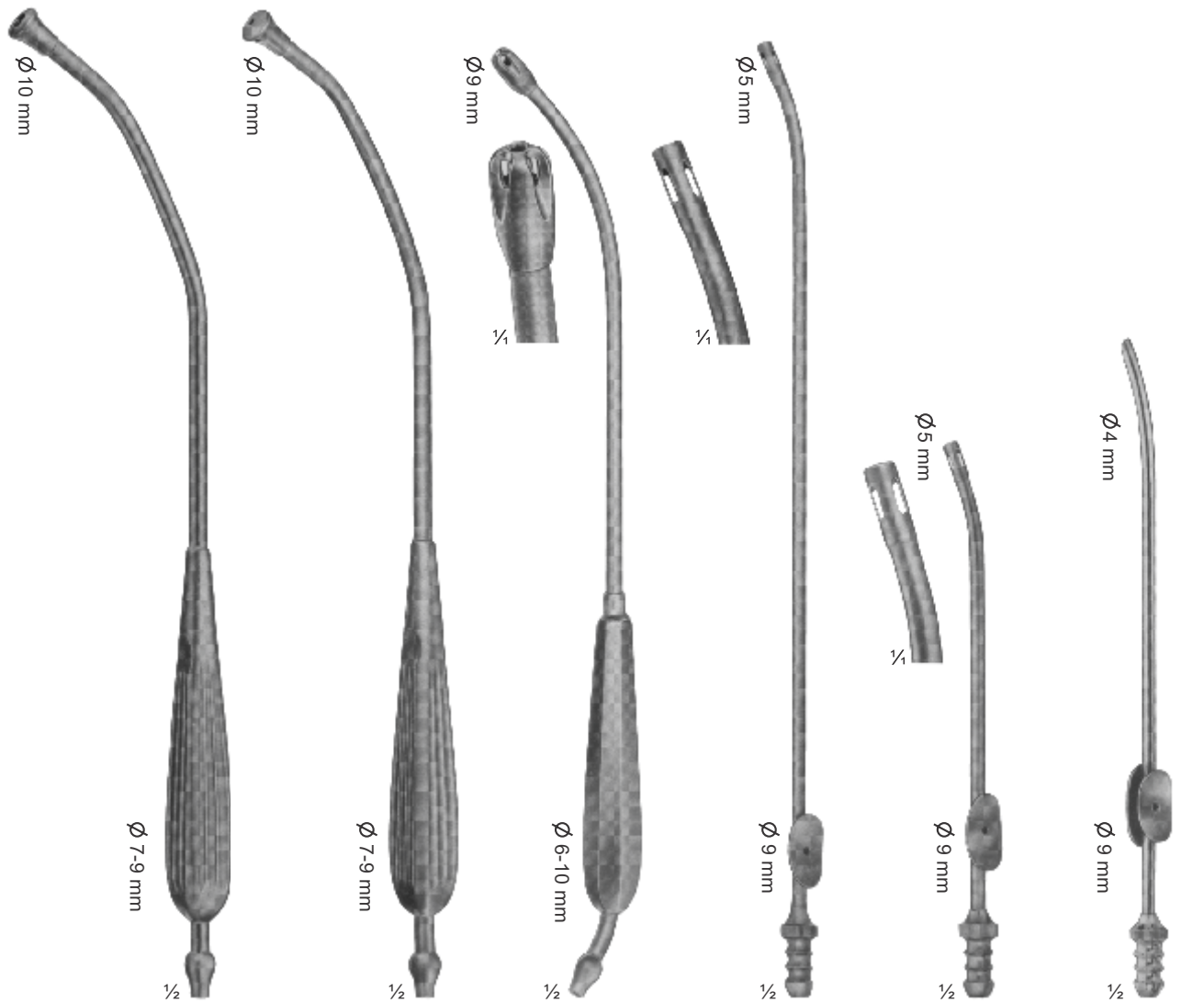

CM26-105
YANKAUER
with especially large
central bore, 4,8 mm
diam.
285 mm

CM26-106
YANKAUER
with central bore,
2,0 mm diam.
285 mm

CM26-107
DE-BAKEY
with central bore,
3,0 mm diam.with
lateral slots
275 mm

CM26-108
DE-BAKEY
with finger cut-off
and stylet
270 mm

CM26-109
DE-BAKEY
with finger cut-off
and stylet
160 mm

CM26-110
with finger
cut-off
190 mm

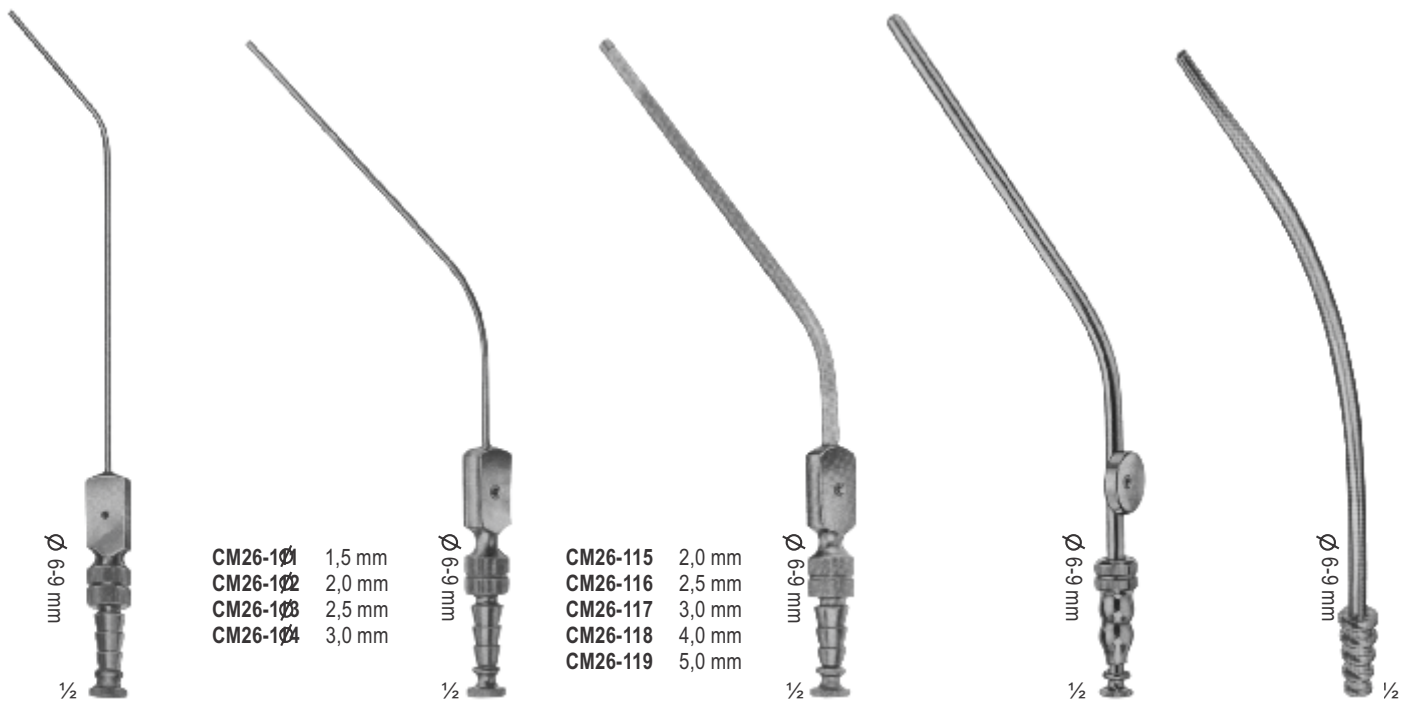

CM26-111 - 114
PLESTER
 with finger cut-off and
 stylet, thumb piece
 parallel to curved, with
 LUER hub
 195 mm

CM26-115 - 119
FERGUSON
 with finger cut-off and
 stylet, thumb piece
 90° to curved, with
 LUER hub
 180 mm

CM26-120 4,0 mm
FERGUSON
 insulated, with finger cut-off
 and stylet, thumb piece 90°
 to curved, with LUER hub
 180 mm

CM26-121 3,0 mm
CM26-122 5,0 mm
FRAZIER
 insulated, with finger
 cut-off and stylet, thumb
 piece 90° to curved,
 with LUER hub
 180 mm

CM26-123
 5,0 mm diam., Tip
 6,5 mm wide, Nasal
 suction tube, with
 LUER hub
 180 mm



CM26-124 4,5 mm
CM26-125 5,5 mm
Nasal suction tubes
175 mm



CM26-126
GORNEY
Suction dissector
180 mm



CM26-127 4 mm wide
CM26-128 5 mm wide
Suction raspatories,
sharp, bayonet-shaped,
with styelt
200 mm



CM26-129
LOPEZ-REINKE
Tonsil dissector with
suction device
235 mm



CM26-130
SPACKMAN CANNULA
Surgical and Latexfree
Cone the depth of the uterus
and to allow
for gentle dilation of the cervix
Length: 360 mm



CARE MEDICAL[®]
SUPPLIES

Your health _ Our Priority

Section

27

Page 564-580

- Hollowares
- Forceps Jars
- Round Metal Boxes And Medicine Cups
- Needle Cases
- Storing Cases
- Sterilizing Baskets / Trays
- Sterilizing Basket
- Holloware And Instruments Trays
- Instruments Kits
- Dilator Instruments & Sets



CM27-001 - 015
Schimmelbusch

Ø x H
sizes in mm

CM27-001	80 x 80
CM27-002	105 x 120
CM27-003	140 x 140
CM27-004	160 x 120
CM27-005	160 x 150
CM27-006	190 x 150
CM27-007	190 x 190
CM27-008	240 x 160
CM27-009	240 x 240
CM27-010	290 x 160
CM27-011	290 x 240
CM27-012	340 x 160
CM27-013	340 x 340
CM27-014	390 x 190
CM27-015	390 x 290

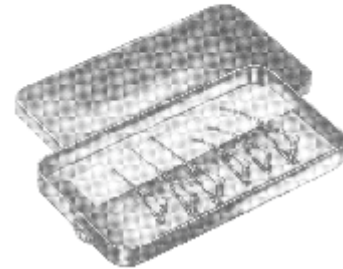

CM27-016
Box
120 x 65 x 13mm
(without Bulldog clamps,
without silicone tape)



CM27-017
Box with support
120 x 65 x 13 mm
(ohne Bulldogklemmen)



CM27-018
Box with support for
needle electrodes,
without instruments

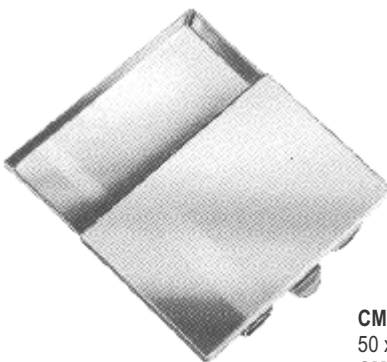

CM27-019 - 020
50 x 25 x 4,5 mm
CM27-019
65 x 42 x 8 mm
CM27-020
75 x 25 x 4,5 mm



CM27-021
Ø65mm x 15mm



CM27-022 - 030

	Ø x H
CM27-022	30 x 90 mm
CM27-023	50 x 100 mm
CM27-024	50 x 130 mm
CM27-025	50 x 175 mm
CM27-026	75 x 100 mm
CM27-027	75 x 130 mm
CM27-028	75 x 175 mm
CM27-029	100 x 175 mm
CM27-030	100 x 200 mm



13-131 - 038

CM27-031	165 x 85 x 35 mm
CM27-032	200 x 100 x 35 mm
CM27-033	200 x 100 x 50 mm
CM27-034	230 x 130 x 50 mm
CM27-035	260 x 150 x 50 mm
CM27-036	270 x 235 x 50 mm
CM27-037	300 x 200 x 50 mm
CM27-038	325 x 275 x 50 mm

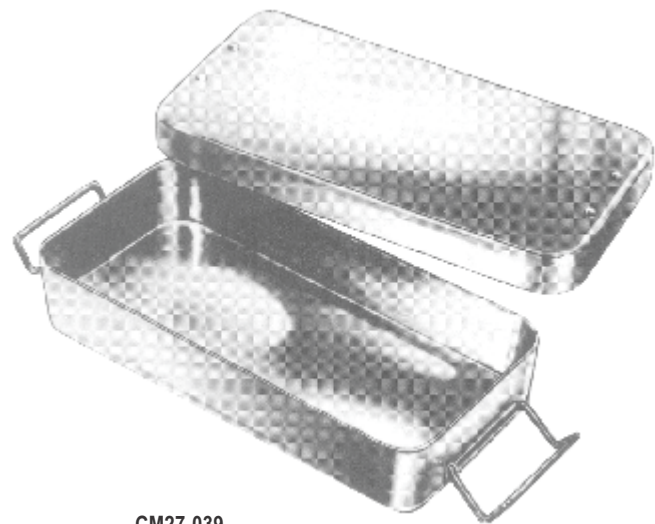

CM27-039
205 x 105 x 35 mm

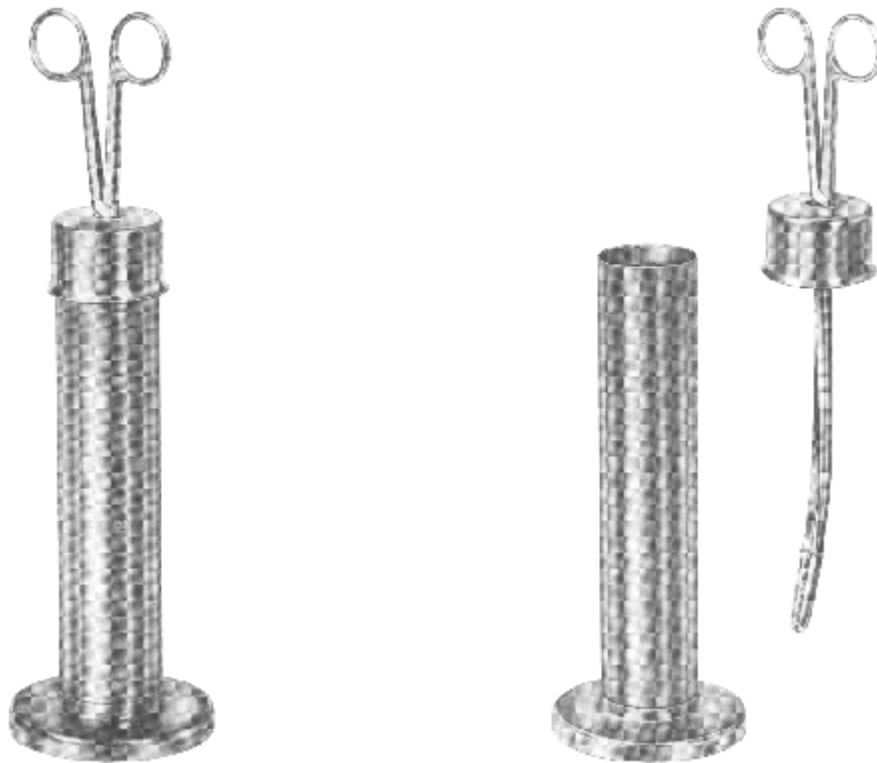

CM27-040 - 041

- CM27-040** | Martin Sterilizing Forceps
consisting of:
1 Sterilizing Forceps, curved, 25 cm,
without ratchet, with lid for jar
1 jar with bottom plate (anti-tilt)
- CM27-041** | ditto, with 32 cm long Sterilizing Forceps

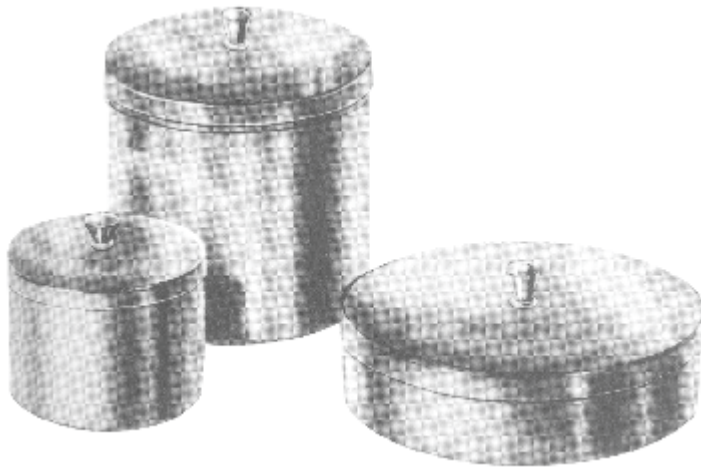

CM27-043 - 048 $\varnothing \times H$

CM27-042	75 x 60 mm
CM27-043	75 x 75 mm
CM27-044	100 x 60 mm
CM27-045	100 x 100 mm
CM27-046	125 x 80 mm
CM27-047	125 x 125 mm
CM27-048	150 x 150 mm

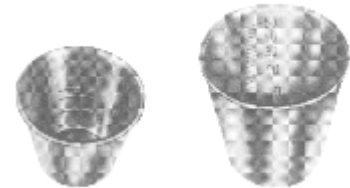

CM27-049 **CM27-050**
25 cc 50 cc



CM27-052
 $\varnothing 75 \times 80$ mm
Sputum Cup



CM27-051
 $\varnothing 90 \times 90$ mm
Metal Cup



CM27-053
20 cc
Medicine Spoon

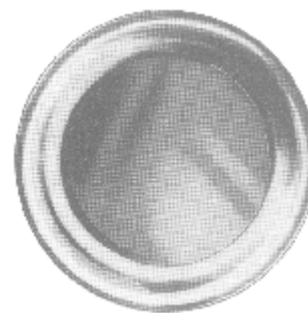

CM27-054
 $\varnothing 75 \times 12$ mm
Tablet Tray



CM27-055 - 062

Ø x H

CM27-055	40 x 19	mm	0.05L
CM27-056	61 x 30	mm	0.07L
CM27-057	80 x 40	mm	0.14L
CM27-058	116 x 50	mm	0.35L
CM27-059	128 x 55	mm	0.45L
CM27-060	147 x 65	mm	0.70L
CM27-061	167 x 75	mm	1.10L
CM27-062	187 x 85	mm	1.60L



CM27-063 - 067

CM27-063	116 x 35	mm	0.30L
CM27-064	128 x 38	mm	0.40L
CM27-065	147 x 40	mm	0.50L
CM27-066	157 x 45	mm	0.75L
CM27-067	187 x 45	mm	1.00L



CM27-068
Ø110 x 28 mm 0.15L



CM27-069
100 cc 0.1L



CM27-070 - 073
CM27-070 0,25L
CM27-071 0,50L
CM27-072 1,00L
CM27-073 2,00L

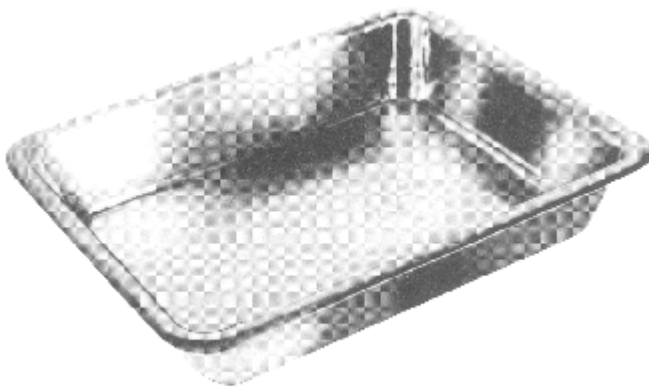

CM27-074
235 x 190 x 40 mm

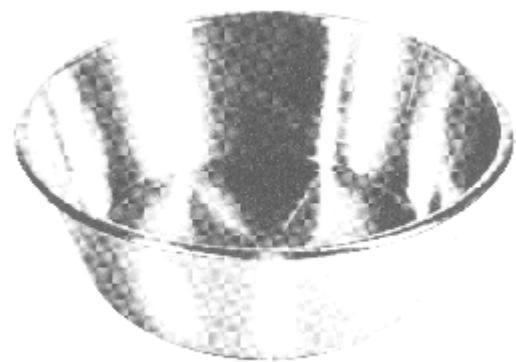

CM27-075
Ø 220 x 70 mm

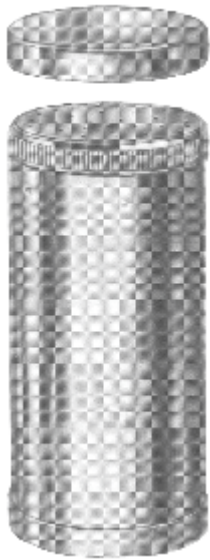

CM27-076
Ø50 x 100 mm
Powder Pot



CM27-077
50 x 75 mm
Methot With Lid



CM27-078
Ø50 x 75 mm
Methot Without Lid

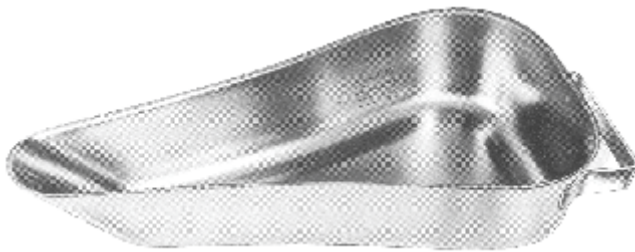

CM27-079

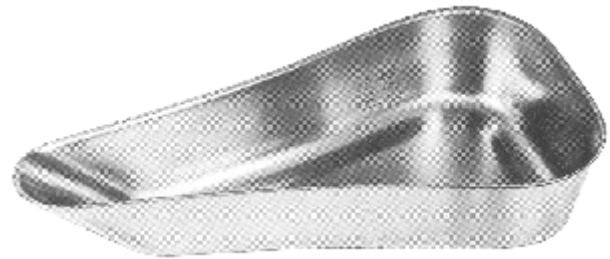

CM27-080

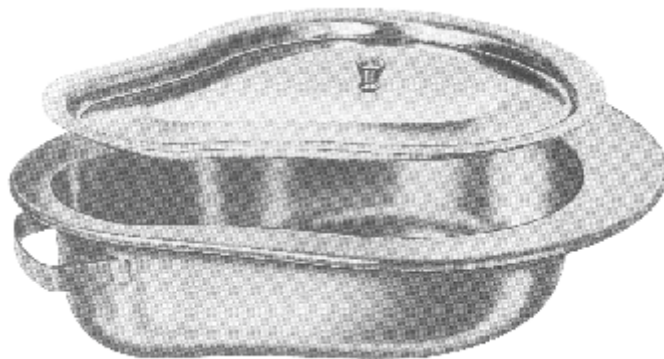

CM27-081

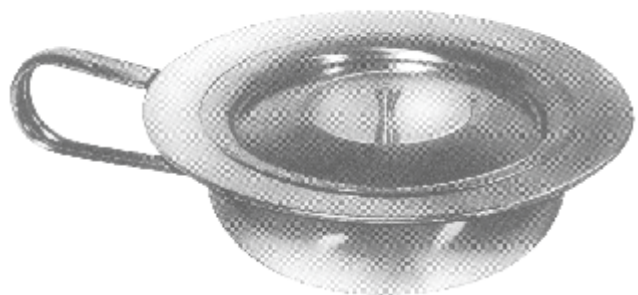

CM27-082 - 083

CM27-082 Ø235 mm
CM27-083 Ø310 mm

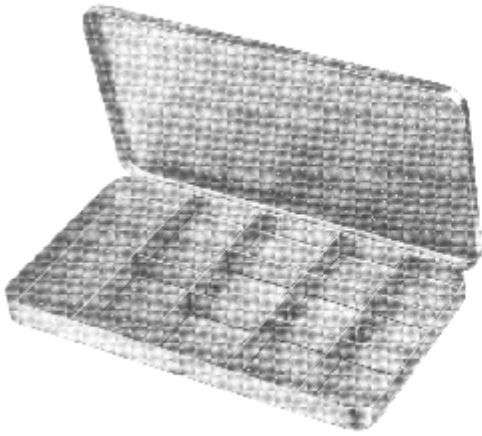

CM27-084
Sauerbruch
210 x 125 x 17 mm



CM27-085
Sauerbruch
210 x 125 x 17 mm

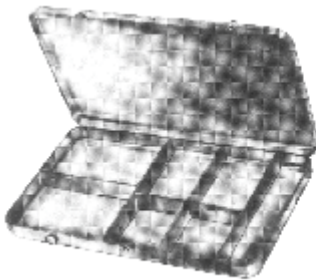

CM27-086
150 x 95 x 13 mm



CM27-087
150 x 95 x 13 mm

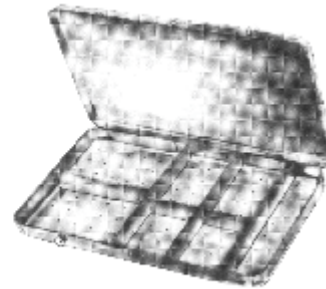

CM27-088
150 x 95 x 13 mm

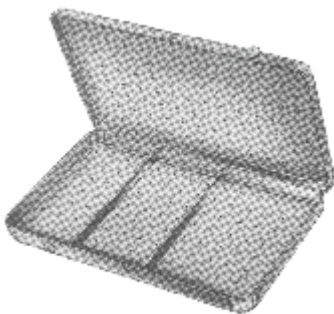

CM27-089
150 x 95 x 13 mm

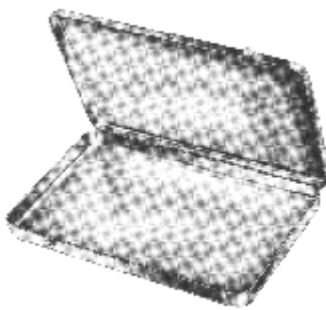

CM27-090
150 x 95 x 13 mm

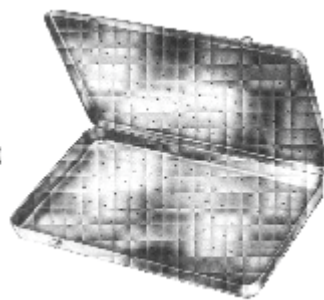

CM27-091
150 x 95 x 13 mm

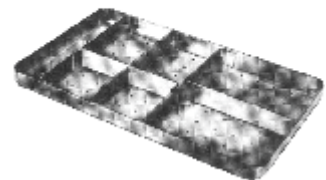

CM27-092
150 x 95 x 11 mm

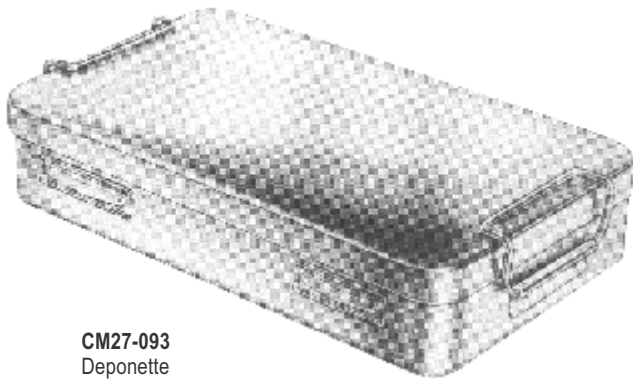

CM27-093
Deponette
245 x 135 x 35mm

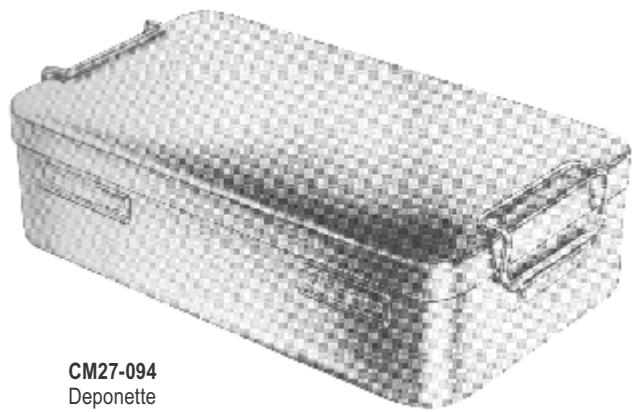

CM27-094
Deponette
245 x 135 x 50mm

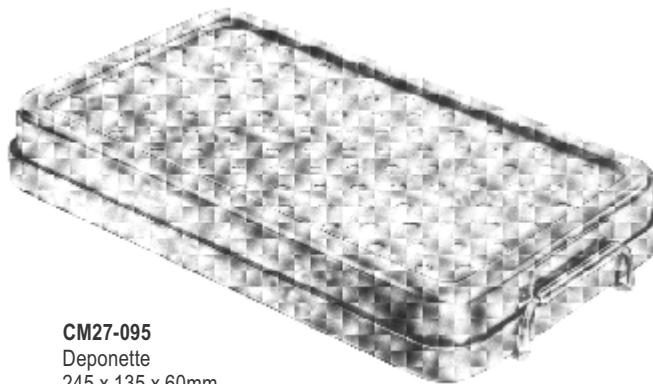

CM27-095
Deponette
245 x 135 x 60mm

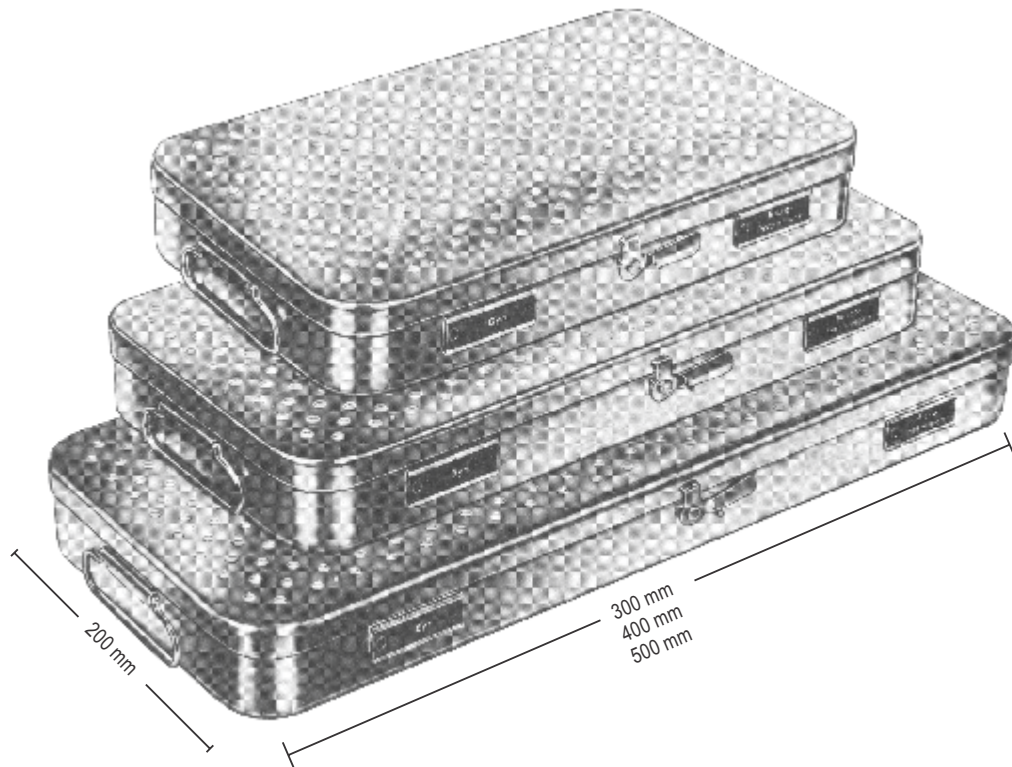

CM27-096 - 106

CM27-096	230 x 130 x 50 mm
CM27-097	260 x 150 x 50 mm
CM27-098	275 x 235 x 50 mm
CM27-099	300 x 200 x 50 mm
CM27-100	325 x 275 x 50 mm
CM27-101	420 x 175 x 50 mm
CM27-102	230 x 130 x 75 mm
CM27-103	260 x 150 x 75 mm
CM27-104	300 x 200 x 75 mm
CM27-105	325 x 275 x 75 mm
CM27-106	420 x 175 x 75 mm

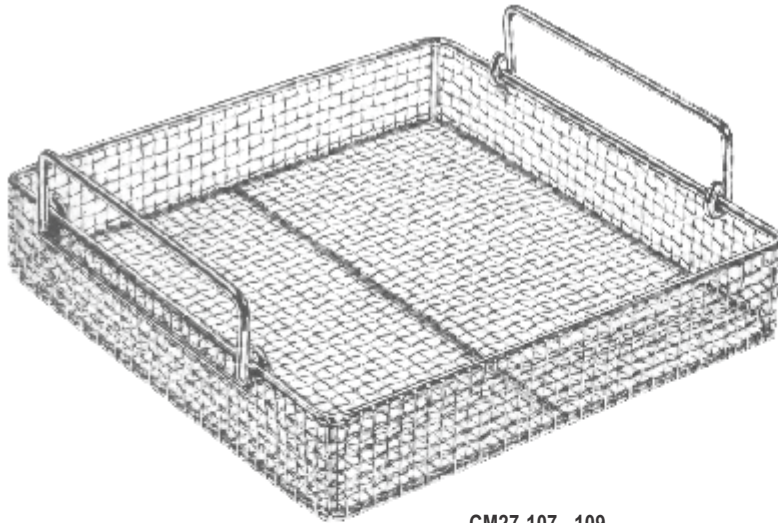

CM27-107 - 109

- CM27-107 480 x 250 x 50 mm
- CM27-108 520 x 250 x 75 mm
- CM27-109 520 x 250 x 100 mm

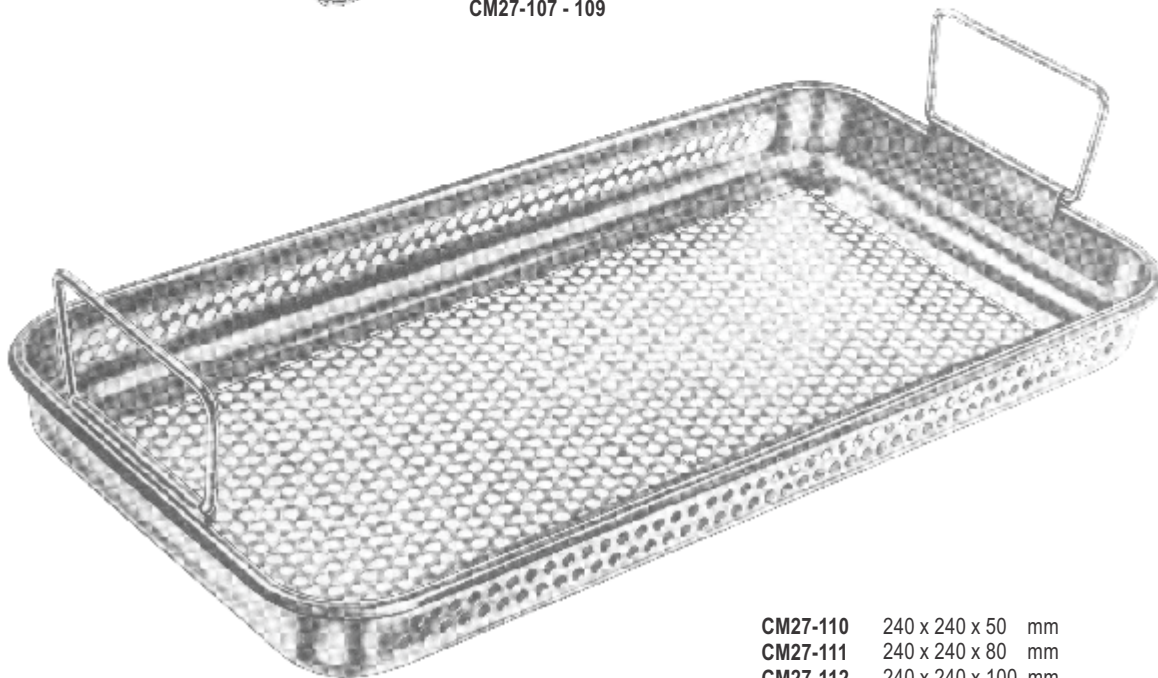

CM27-110 - 115

- CM27-110 240 x 240 x 50 mm
- CM27-111 240 x 240 x 80 mm
- CM27-112 240 x 240 x 100 mm
- CM27-113 480 x 260 x 50 mm
- CM27-114 520 x 260 x 80 mm
- CM27-115 520 x 260 x 100 mm

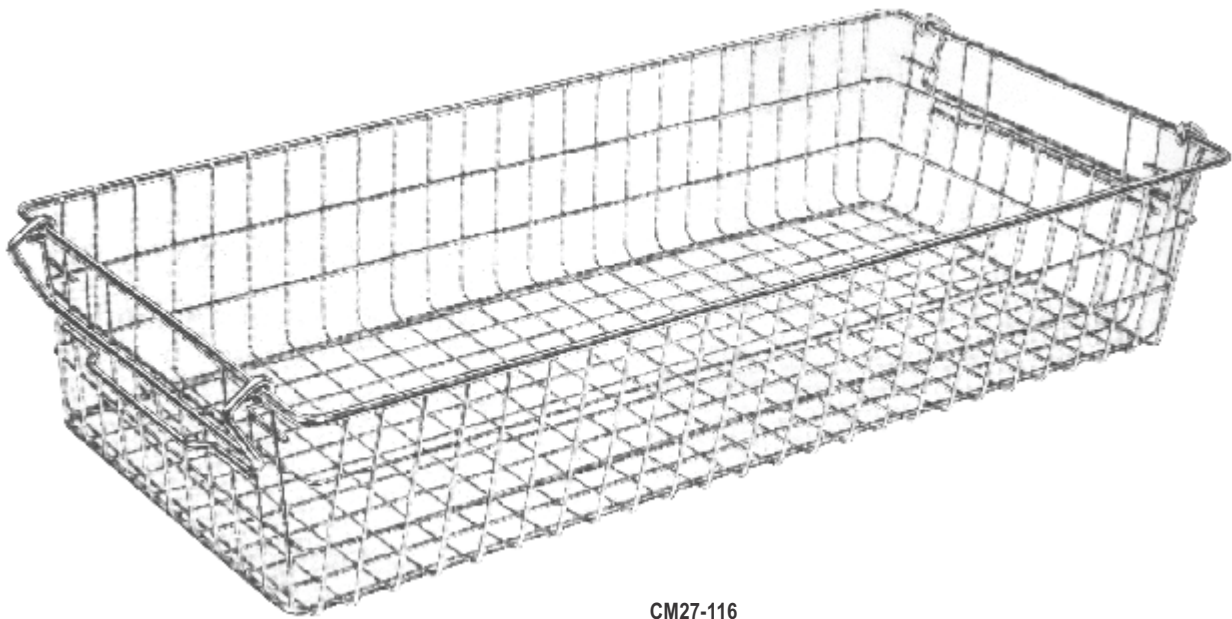

CM27-116
(60 x 30 x 15 cm)
Nominal dimensions

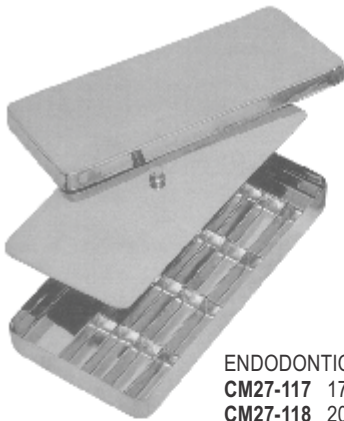

ENDODONTIC BOX
CM27-117 17X17X3 cm
CM27-118 20X10X4 cm
CM27-119 25X12X6 cm
CM27-120 30X14X6 cm

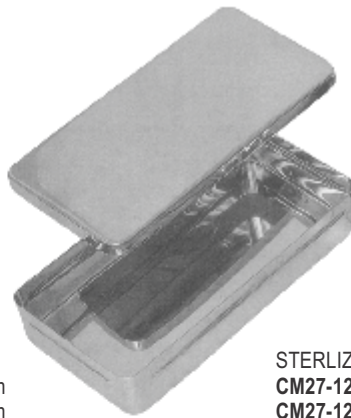

STERILIZING BOX
CM27-121 17X17X3 cm
CM27-122 20X10X4 cm
CM27-123 25X12X6 cm
CM27-124 30X14X6 cm



ENDO TRAY BOX
CM27-125



INSTRUMENT BOX WITH LOCK
CM27-126 8" X 4" X 1/2"
CM27-127 8" X 6" X 2"
CM27-128 10" X 6" X 2"
CM27-129 12" X 6" X 2"
CM27-130 12" X 8" X 2"



INSTRUMENT BOX
CM27-131 8" X 4" X 1
CM27-132 8" X 6" X 2"
CM27-133 10" X 6" X 2"
CM27-134 12" X 6" X 2"
CM27-135 12" X 8" X 2"



PERFORATED STERILIZING BOX
CM27-136 8" X 4" X 1
CM27-137 8" X 6" X 2"
CM27-138 10" X 6" X 2"
CM27-139 12" X 6" X 2"
CM27-140 12" X 8" X 2"



STERILIZING DRUM
CM27-141
 6"x5"



STERILIZING DRUM
CM27-142
 6"x6"



STERILIZING DRUM
CM27-143
 8"x8"



IRRIGATOR (DOUCH CAN)
CM27-144 1000 ml
CM27-145 1500 ml
CM27-146 2000 ml



GRADUATED JUG
CM27-147 500 ml
CM27-148 1000 ml
CM27-149 2000 ml



KIDNEY TRAY
CM27-150
 Emesis Basins (Deep)
 5" 6" 8" 10" 11" 12" 14"



OUNCES
CM27-151
10, 20, 40, 60, 80



OUNCE
CM27-152
40



SPITTEN MUG
CM27-153



SPIRIT LAMP
CM27-154



PERFORATED TRAY
CM27-155 288 X 187 X 40 mm
CM27-156 180 X 140 X 40 mm



PERFORATED BASE
CM27-157 288 X 187 X 40 mm
CM27-158 180 X 140 X 40 mm

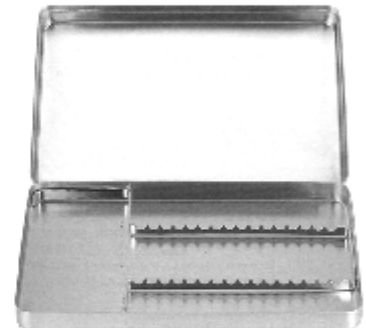

SOLID BASE
CM27-159 288 X 187 X 40 mm
CM27-160 180 X 140 X 40 mm



INSTRUMENTS TRAY
CM27-161
8" X 4" X 1"



INSTRUMENTS TRAY
WITH COVER
CM27-162 8" X 6" X 2"
CM27-163 10" X 8" X 2"
CM27-164 12" X 7" X 2"



INSTRUMENTS TRAY
PERFORATED
CM27-165
12" X 6" X 1"



INSTRUMENTS TRAY
SHALLOW MAYO
CM27-166 8" X 6" X 1½"
CM27-167 9" X 6" X 1½"
CM27-168 12" X 8" X 2"



SCALER TRAY
CM27-169 200 X 100 X 15 mm
CM27-170 200 X 150 X 15 mm



CATHETER TRAY
CM27-171 222 X 82 X 40 mm
CM27-172 225 X 125 X 50 mm
CM27-173 325 X 90 X 50 mm



Dissecting Kit - Set of 9 Pcs
M-611-001

- Probe 14 cm
- Scalpel Handle 15 cm
- Scalpel Handle 15 cm
- Butterfly probe
- Dressing Forcep 13 cm
- Kocher Forcep 13 cm
- Dressing Scissor S/B Str 13 cm
- Dressing Scissor S/B Cvd 13 cm
- Needle Holder Forcep 13 cm



Dissecting Kit - Set of 9 Pcs
M-611-002

- Butterfly probe
- Probe 14 cm
- Needle Holder Forcep 14 cm
- Scalpel Handle # 3
- Scalpel Handle # 4
- Dressing Scissor S/B Str 14 cm
- Dressing Scissor S/B Cvd 14 cm
- Dressing Forcep 14 cm
- Kocher Forcep 1x2 Teeth 14 cm



Dissecting Kit - Set of 13 Pcs
M-611-003

- Frazier Hook 15 cm
- Scalpel Handle 15 cm
- Scalpel Handle 15 cm
- Scalpel Handle # 3 (Scalling Engraved)
- Dressing Forcep 13 cm
- Butterfly Probe
- Probe Scissor Str 14 cm
- Probe 14 cm
- Scalpel Blade # 10 (5 Pcs)



Dissecting Kit - Set of 13 Pcs
M-612-004

- Chain Hook 3
- Needle Holder Forcep 14 cm
- Kelly Forcep Str 14 cm
- Kelly Forcep Cvd 14 cm
- Scalpel Handle # 3
- Farabeuf Retractor
- Dressing Scissor S/B Str 14 cm
- Dressing Scissor S/B Cvd 14 cm
- Mosquito Forcep 14 cm
- Kocher Forcep 14 cm
- Dressing Forcep 14 cm
- Eye Probe
- Butterfly probe

Dissecting Kit - Set of 19 Pcs
M-612-005

- Operating Scissor S/B Str 14 cm
- Operating Scissor S/B Cvd 14 cm
- Mosquito Forcep Str 13 cm
- Kelly Forcep Str 14 cm
- Kelly Forcep Cvd 14 cm
- Mayo Hegar Needle Holder 14 cm
- Butterfly probe
- Kocher Forcep 14 cm
- Dressing Forcep 14 cm
- Scalpel Handle # 3
- Scalpel Handle # 4
- Needle Straight (Plastic Handle)
- Needle Curved (Plastic Handle)
- Farabeuf Retractor
- Probe With Hole 14 cm
- Needle With Thread
- Surgical Sterile Blade # 3
- Surgical Sterile Blade # 4
- Chain Hook



Dissecting Kit - Set of 20 Pcs
M-612-006

- Scalpel Handle # 3
- Simken Forcep Str 12 cm
- Simken Forcep Cvd 12 cm
- Simken Kocher Forcep Str 10 cm
- Mosquito Forcep Cvd 12 cm
- Plastic Handle Probe Str 13 cm
- Plastic Handle Probe Cvd 13 cm
- Dressing Scissor S/B Str 14 cm
- Iris Scissor Str 12 cm
- Frazier Hook 15 cm
- Surgical Sterile Blade # 10 (10 Pcs)





Dissecting Kit - Set of 35 Pcs
M-613-007

- Probe
- Butterfly Probe
- Dressing Forcep 14 cm
- Kocher Forcep 1x2 Teeth 14 cm
- Micro Forcep 12.5 cm
- Surgical Sterile Blade # 3
- Surgical Sterile Blade # 4
- Scalpel Knife 15 cm
- Dissecting Spatula
- Mosquito Forcep Cvd 12.5 cm
- Iris Scissor Str 11.5 cm
- Magnifying Glass (Plastic Handle)
- Operating Scissor S/B Str 14 cm
- Needle Curved Point 14.5 cm
- Needle Straight Point 14.5 cm
- Surgical Sterile Blade # 22 (10 Pcs)
- Surgical Sterile Blade # 10 (10 Pcs)

- Iris Scissor Str 11.5 cm
- Operating Scissor S/S Str 14 cm
- Operating Scissor S/B Str 14 cm
- Operating Scissor B/B Str 14 cm
- Surgical Sterile Blade # 3
- Surgical Sterile Blade # 4
- Needle Straight Point 14 cm
- Needle Curved Point 14 cm
- Probe
- Probe With Hole 14 cm
- Butterfly Probe
- Frazier Hook 17 cm
- Dressing Forcep 14 cm
- Kocher Forcep 14 cm
- Micro Forcep 12.5 cm
- Simken Forceps 10 cm
- Simken Forceps 10 cm Cvd Serrated
- Simken Forceps 10 cm Cvd Serrated
- Kelly Forcep Str 14 cm
- Kelly Forcep Cvd 14 cm
- Mosquito Forcep Str 12.5 cm
- Mosquito Forcep Cvd 12.5 cm
- Surgical Sterile Blade # 22 (10 Pcs)
- Surgical Sterile Blade # 10 (10 Pcs)

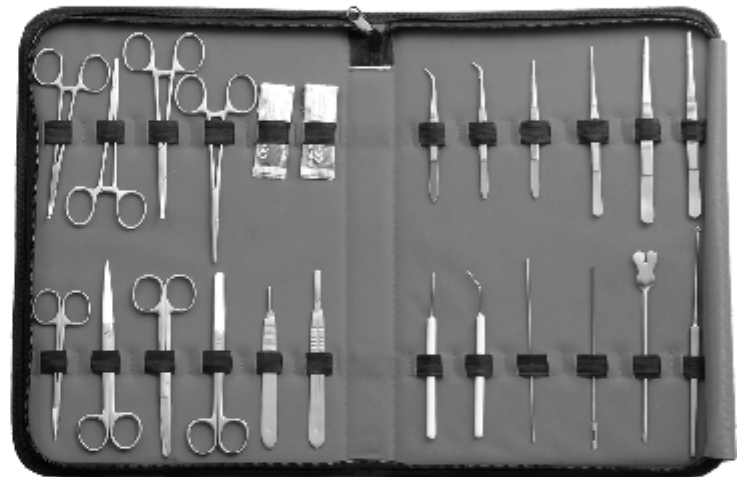

Dissecting Kit - Set of 42 Pcs
M-613-008

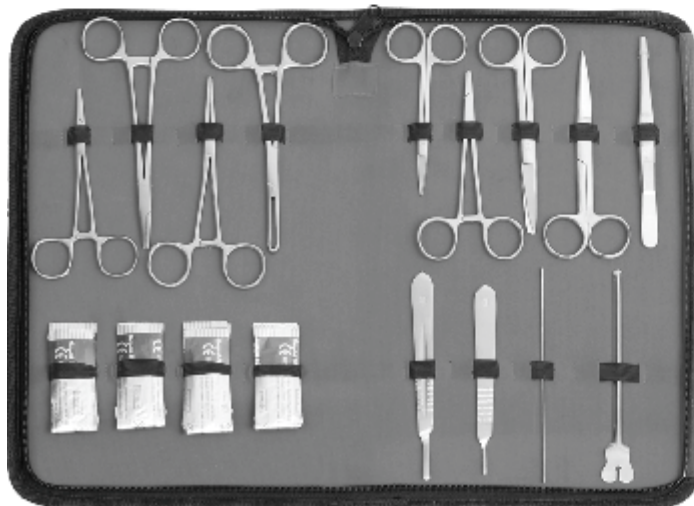

Dissecting Kit - Set of 53 Pcs
M-613-009

- Operating Scissor S/B Str 14 cm
- Mayo Scissor Str 14 cm
- Kelly Forcep Str 14 cm
- Allis Tissue Forcep 1x2 Teeth 14 cm
- Dressing Forcep 14 cm
- Mosquito Forcep Str 12.5 cm
- Webster Needle Holder 12.5 cm
- Mayo Hegar Needle Holder 15 cm
- Iris Scissor Str 11.5 cm
- Surgical Sterile Blade # 3
- Surgical Sterile Blade # 4
- Double Ended Probe 14 cm
- Butterfly Probe
- Surgical Sterile Blade # 22 (10 Pcs)
- Surgical Sterile Blade # 10 (10 Pcs)
- Surgical Sterile Blade # 11 (10 Pcs)
- Surgical Sterile Blade # 15 (10 Pcs)



Dissecting Kit - Set of 6 Pcs
M-614-010

- Probe
- Butterfly
- BP Handle # 4
- Kelly Forcep Str 14 cm
- Dressing Scissor Str 14 cm
- Dressing Scissor Serrated 14 cm

Dissecting Kit - Set of 12 Pcs
M-614-011

- Probe
- Butterfly
- BP Handle # 4
- Farabeuf 12 cm
- Kelly Forcep Str 14 cm
- Kelly Forcep Cvd 14 cm
- Mosquito Forcep Str 13 cm
- Dressing Scissor Str S/B 14 cm
- Dressing Scissor Cvd S/B 14 cm
- Mayo Hegar Needle Holder 14 cm
- Dressing Forcep Serrated 14 cm
- Dressing Forcep 1x2 Teeth 14 cm



Dissecting Kit - Set of 17 Pcs
M-614-012

- Probe
- Butterfly 14 cm
- Dressing Forcep 14 cm
- Kocher Forcep 1x2 Teeth
- Scalpel Handle # 3
- Scalpel Handle # 4
- Needle Forcep 14 cm
- Kelly Forcep Str 14 cm
- Kelly Forcep Cvd 14 cm
- Plastic Hnalde Probe Str 13 cm
- Plastic Hnalde Probe Cvd 13 cm
- Farabeuf 12 cm
- Mosquito Forcep Cvd 13 cm
- Iris Scissor Str 11.5 cm
- Dressing Scissor Str 14 cm
- Dressing Scissor Cvd 14 cm
- Chain Hook





CM-27-183
Small Dilators German Steel 18/8



CM-27-184
Hank Dilators German Steel 18/8



CM-27-185
Mini Dilators Set German Steel 18/8



CM-27-186
Dilators Sterilization Tray German Steel 18/8



CM-27-187
Mini Dilators Sterilization Tray German Steel 18/8



CM-27-188
Hegar Dilators Sterilization Tray German Steel 18/8

A			
Abraham Tonsil Knife	12	Babcock Intestinal Grasping Forceps	215
Abraham Tonsil Knives	513	Babcock Multi-Purpose Clamps	347
Adson Delicate Dissecting Forceps	74	Baby Nail Scissor	49
Adson Delicate Haemostatic Forcep	90	Baby-Adson Dissecting and Ligature Forcep	97
Adson Delicate Tissue Forcep	79	Baby-Collin Abdominal Retractors	195
Adson Dura Protecting Forceps	494	Baby-Crile Delicate Haemostatic Forcep	90
Adson Forceps with TC	86	Baby-Kocher Intestinal Clamps for Children	19
Adson Needle Holder	126,127	Baby-Metzenbaum Dissecting Scissors	40
Adson Raspatories	396	Baby-Metzenbaum Super Cut Scissor	66
Adson Self-Retaining Laminectomy Retracto	192,193	Baby-Metzenbaum TC Scissor	54
Adson Suction Instruments	557	Baby-Mikulicz Peritoneum Forcep	106
Adson-Baby Self-Retaining Retractor	191,199	Baby-Mixer Dissecting and Ligature Forcep	97
Adson-Brown Tissue Forceps	81	Baby-Mosquito (Hartmann) Delicate Haemostatic Forcep	89
Aesculap Sponge & Dressing Forcep	117	Baby-Overholt Dissecting and Ligature Forcep	97
Aesculap Tissue grasping forcep	122	Baby-Roux Retractor	160
Alan-Parks Rectal Speraders	257	Baby-Senn-Miller Retractor	160
Alexander Bone Rongeurs	439	Baby-Tischler Specimen Forceps	294
Alexander Gouges	430	Backhaus Towel Clamp Forceps	123
Alexander Rib Raspatories	366	Backhaus-Kocher Towel Clamp Forceps	123
Allen Intestinal Clamps for Children	219	Bailey Rib Spreaders	314
Allis Forceps	217	Bainbridge Intestinal Clamps for Children	219
Allis Multi-Purpose Clamps	347	Bakes Dilators & Scoops	259
Allis Tissue Grasping Forceps	214	Balfour Abdominal Retractors	197
ALM Self Retaining Retactors	546	Balfour-Baby Abdominal Retractors	196
ALM Wound Spreaders, Self-Retaining	198	Ballenger Adenoid Curttes	520
Aly Aesthesiometers	1	Ballenger-Hajek Periosteal Elevators	515
Amputating Knives	11	Bane-Hartmann Bone Rongeurs	438
Anderson-Adson Retractors for Cervical Vertebral Column	209	Barnhill Adenoid Curttes	520
Anderson-Adson Self-Retaining Laminectomy Retractor	192	Baron-Schuknecht Suction Instruments	561
Andrew Tongue Depressors	3	Barr Intestinal and Pylorus Clamps	237
Arruga Delicate Tissue Forcep	79,542	Barraquer Eye Specula	545
Arruga Needle Holder for Micro Surgery	547	Barraquer Micro Needle Holde	549
Asch Biopsy Curettes	282	Barraquer Micro Spring Scissor	538
Asch Septum Forceps	518	Barraquer Needle Holder with TC	551
Aufricht Nasal Rasps	516	Barraquer Needle Holder With Tungsten Carbide Inserts	146
Austin Micro Forcep	71	Barry Sternal Needle Holder with TC	142
Autopsy Knives	11	Barth Bone Curette	399
Auvard Vaginal & Wound Retractor	270	Baumgartner Needle Holder	127
Ayre Cone Knife	12	Beckmann Adenoid Curttes	520
B		Beckmann Nasal Specula	509
Babcock Forceps	217	Beckmann-Adson Retractors for Cervical Vertebral Column	211
		Beckmann-Adson Self-Retaining Laminectomy Retractor	193
		Beckmann-Eaton Retractors for Cervical Vertebral Column	211
		Beckmann-Eaton Self-Retaining Laminectomy Retractor	193

Beebe Ligature Scissor	48	Bowman Probe	149
Beer Splinter and Cilia Forceps	84	Boynton Needle Holder	130
Beeson Plaster Spreader	467	Boys-Allis Tissue Grasping Forceps	214
Belucci Micro Ear Forceps	504	Bozemann - Douglas Uterine Dressing Forcep	277
Bending Plier	447	Bozemann Needle Holder with TC	142
Bengolea Delicate Haemostatic Forcep	91	Bozemann Uterine Dressing Forcep	276,277
Benson Stomach Clamps	232	Bozemann Uterine Scissor	44
Berger Biopsy Forcep	283,285,287	Braithwatte Gum, Phalangeal And Skin Grafting Knives	20
Bergmann Mallet	416	Brand Tendon Holding Forceps	405
Bergmann Retractor	155	Braun Obstetrics-Placenta	298
Berliner Percussion Hammers	1	Braun Perforator Carnioclax	302
Bertillon Measuring Instruments	8	Braun Uterine Probes	275
Beyer Bone Rongeurs	439	Braun Uterine Tenaculum Forcep	278
Biemer Micro Scissors	536	Braun Vaginal Speculums for Children	267
Biemer Vacuum Curettes	552	Braun-Standler Empisiotomy Scissor	45
Bier Amputation Saws	377	Braun-Standler Universal & Bandage scissor	51
Billeau Ear Loops - Hooks	501	Breisky Obstetrics Pelvimeters	295
Biopsy Forcep	289	Breisky Wiener Model Vaginal Specula	269
Bircher Meniscus and Carilage Forceps	413	Briesky Vaginal Specula	263
Bircher-Ganske Meniscus and Carilage Forceps	413	Brinkerhoff Intestinal and Pylorus Clamps	237
Bishop-Harmon Delicate Tissue Forcep	79	Brom Vessel Hooks	469
Blake Gall Stone Forceps	249,253	Brophy Delicate Dissecting Forceps	75
Blake Uterine Scoops	291	Brophy Tissue Forceps	82
Blake Vascular Dilators	355	Brown Tissue Forceps	81
Blumenthal Bone Rongeurs	438	Bruenings Biopsy Forcep	289
Boer Basiotribe Forceps	298	Bruenings Tonsil Snare	523
Bohler Bone Cutting Forceps	443,448	Brunings Tongue Depressors	3
Bohler Bone Rongeurs	440	Brunings Tonsil Knife	12,513
Boley Measuring Instruments	8	Brunner Guide Probe	135
Bone Curette	423	Brunner Intestinal Clamps, Soft Elastic	227
Bone Hand Drills	385	Brunner Retractors for Deep surgery	171,176
Bone Holding Forcep	406,409,435	Brunner Rib Shears	362
Bone Levers	388,389,391	Brunnings Exchangeable Tips	533
Bone Rongeur	508	Bruns Universal & Bandage scissor	51
Bonn Eye Scissors	540	Bruns Bone Curette	401
Bonn Micro Eye Forcep	543	Buchs Retractors	168
Bonney Forceps with TC	86	Buchwald Tongue Depressors	3
Bonney Lung Dissecting Forceps	83	Buck Cotton Applicator	150
Bose Hooks and Dilators	303	Buck Ear Specula	499
Bose Retractor	155	Buck Paracentesis Needles	502
Bose Wound Spreaders, Self-Retaining	198	Buck Percussion Hammers	1
Boucheron Ear Specula	498	Buck-Gramcko Bone Levers	391
Bowl Hallow Wares	569	Buie Biopsy Forceps and Swab Holders	240
Bowman Lachrymal Probes	545	Bumm Uterine Curette	292

Bumm Uterine Scoops	291	Claus Van Eicken Suture Instruments	133,136
Bunnell Bone Hand Drills	384	Cleaning Brush Hooks and Dilators	303
Bunnell Tendon Strippers	452	Cloth Scissor	51
Bunt Towel Clamp Forceps	125	Cloward Lamina Spreader	201
Burke Cervical Biopsy	293	Cloward Modif Retractors for Cervical Spine	206
Bushe Bone Curette	403	Cloward-Type Retractors for Cervical Vertebral Column	493,207,490
Byrd Suction Instruments	557	Coakley Trocars	260
C			
Caplan Septum Forceps	519	Cobb Osteotomes, Chisels	424
Carroll Measuring Instruments	8	Cobbett Gum, Phalangeal And Skin Grafting Knives	20
Carroll Tendon Holding Forceps	405	Cogswell Suction Instruments	557
Cartilage Knives	11	Colley Suction Instruments	556
Caspar Micro Scissors	536	Collin Abdominal Retractors	195
Caspar Osteotomes, Gouges	419	Collin Clip Apply Froceps	152
Caspar Punches	375	Collin Intestinal Grasping Forceps	215
Caspar Retractors	167	Collin Obstertrics Pelvimeters	295
Caspar Rongeurs	370,373	Collin Rib Shears	464
Casper Brain Retractors	489	Collin Scalpel Handles	14
Casper Dura Hook	471	Collin Sponge & Dressing Forcep	118,120
Casper Guide Probe	135	Collin Tongue Forceps	4
Casper Nerve Root Retractors	475	Collin Umbilical cord clamps	300
Casper Raspatories	396	Collin Uterine Curette	292
Casper Retractors for Cervical Vertebral Column	479-481,483-488	Collin Vaginal Specula	261
Castanesa Multi Purpose Clamps for Neonatales	316,324	Collin-Hartmann Retractor	160
Castroviejo Delicate Tissue Forceps	79,542	Colver Tonsil Instruments	524
Castroviejo Eye Specula	545	Cone Cranial Rongeurs	380
Castroviejo Measuring Instruments	8	Cone Knife	12
Castroviejo Micro Eye Spring Scissor	539	Cone Retractors for Cervical Vertebral Column	208
Castroviejo Micro Scissors	535	Converse Needle Holder	127
Castroviejo Micro Spring Scissor	538	Converse Retractor	154
Castroviejo Needle Holder for Micro Surgery	547	Cooley - Back Anastomosis Clamps, Pediatric Patterns	341
Castroviejo Needle Holder with TC	551	Cooley Aneurysm Clamps	331
Castroviejo Needle Holder With Tungsten Carbide Inserts	145	Cooley Aorta - Anastomosis Clamps	341,342,343,345
Castroviejo Razor Blade Holders & Breakers	18	Cooley Aotric Dilators	360,361
Catheter Tray	577	Cooley Atrium Retractors	180
Catlin Amputating Knives	11	Cooley Multi Purpose Clamps for Neonatales	317
Chain with weight Abdominal Retractors	181	Cooley Multi-Purpose Clamps	344
Chand.Modell Meniscus Knives	446	Cooley Rib Retractors	310
Charriere Amputation Saws	77	Cooley Ring Handle Bulldog Clamp	341
Cheron Sponge & Dressing Forcep	118	Cooley Sternum Spreaders	309
Chevalier - Jackson Broncho - Oesophagoscopy Forceps	525	Cooley Vena Cava Clamps	330
Circular Forceps and Antrum Punch	512	Coolin Forceps	217
Citelli Bone Rongeur	508	Cooper Standard Type Surgical Scissor	33
		Cooper Suture Instruments	133,136
		Cordes Exchangeable Tips	534
		Cottle Bulldog Scissor	35

Cottle Scissor	42	Czerny Uterine Tenaculum Forcep	280
Cottle Chisels	430		
Cottle Forcep	78	D	
Cottle Mallet	414	Dahlgren Cranial Rongeurs	380
Cottle Nasal Rasps	516	Dale Peripheral Vascular Clamps	328
Cottle Osteotomes Chisels	430	Dammschere Bowel Scissor	46
Cottle Periosteal Elevators	515	Dammschere Empisiotomy Scissor	45
Cottle Raspatories	394,396	Dandy Delicate Haemostatic Forcep	89,111
Cottle Retractor	154,159	Dardik Aotric Dilators	360
Cottle Septum Elevators	514	Dardik Multi-Purpose Clamps	237,346
Cottle Super Cut Scissor	67	Daubenspeck Bone Curette	402
Cotton Applicator	150	Davis Vascular Dilators	356
Cotton Uterine Probes	275	Davis-Boyle Mouth Gags	527
Coupland Suction Instruments	557	De Bakey - Back Vena Cava Clamps	321,326
Crafoord Carotid Clamps, Vascular Clamps	349	De Bakey - Bainridge Non-Traumatic Haemostatic Forceps	318
Crafoord Delicate Haemostatic Forcep	91	De Bakey - Harken Vena Cava Clamps	322,326
Crafoord haemostatic Forceps	98	De Bakey - Hess Bulldog Clamps	354
Crafoord-Sellers haemostatic Forceps	98	De Bakey - Kelly Non-Traumatic Haemostatic Forceps	2319,323
Crafoord-Sellers Carotid Clamps, Vascular Clamps	349	De Bakey - Mixer Anastomosis Clamps	320
Crile Delicate Haemostatic Forcep	90	De Bakey - Pean Non-Traumatic Haemostatic Forceps	2319,323
Crile Needle Holder	129	De Bakey - Satinsky Vena Cava Clamps	332
Crile Nerve Hooklets	358	De Bakey Alteriotomy Scissor	36
Crile Retractor	160	De Bakey Aorta Clamp	338
Crile Vessel Hooks	469	De Bakey Aotric Dilators	360
Crile-Murray Needle Holder	126,127	De Bakey Bulldog Clamps	354
Crile-Wood Needle Holder	126,127	De Bakey Dissecting Forceps	53,218
Crile-wood Needle Holder with TC	139	De Bakey Forceps	77,351,352
Cross Action Self Retaining Retactors	546	De Bakey Multi Purpose Clamps for Neonatales	317
Crutchfield Skull Traction Tong	379	De Bakey Multi-Purpose Clamps	340
Cusco Standard Vaginal Specula	262	De Bakey Needle Holder with TC	140
Cusco Vaginal Specula	261,262	De Bakey Rib Spreaders	307
Cushing Delicate Dissecting Forceps	75	De Bakey Ring Handle Bulldog Clamps	315
Cushing Forceps with TC	86	De Bakey Sigmoid Anastomosis Forceps	235
Cushing Hooklets Retractor	182	De Bakey Special Retractors	194,204
Cushing Nerve Hook	470	De Bakey Suction Instruments	557
Cushing Retractor	159	De Bakey Tissue Forceps with TC	87
Cushing Vessel Hooks	469	De Bakey Vascular Dilators	355
Cushing-Kocher Retractor	159	De Bakey Vascular TC Scissor	59
Cushing-Taylor Forceps with TC	86	De Bakey Vena Cava Clamps	330,332,333,334,335,336
Cutical Delicate Scissors	29	De Bakey Vessel Scissors	27
Cuzzi Placenta Scoops	300	De Lee Obstetrics Pelvimeters	295
Czerny Gall Stone Forceps	249	De Vilbiss Cranial Rongeurs	380
Czerny Intestinal and Pylorus Clamps	237	Dean Tonsil Scissors	42
Czerny Retractor	161	Deaver Retractors for Deep surgery	177,178,179

Deaver Surgical Scissor	34	Doyen Mallet	417
De-Bakey Suction Instruments	563	Doyen Rib Raspatories	365
Dejerine Percussion Hammers	1	Doyen Vaginal Specula	268,269
Delicate Dissecting Forceps	75	Doyen-Child Abdominal Retractors	181
Delicate Dissecting, Microscopic, Sterilizing Forceps	74	Drill Guide Brain Retractors	489
Delicate Scissors	29,31	Drill Guide Retractors for Cervical Vertebral Column	488
Demel Suture Instruments	137	Drilling Chucks	457
Denhart Mouth Gags	4,521	Dunhill Delicate haemostatic Forcep	111
Denis Browne Forceps	216	Dupaly Uterine Tenaculum Forcep	279
Denis-Browne Lung Dissecting Forceps	83	Dura Hook	472
Derf Needle Holder	127	Durogrip Wire Tightening Pliers	459
Derf Needle Holder with TC	138	Durotip Wire Cutting Scissors	462
Derra - Cooley Anastomosis Clamps, Pediatric Patterns	342	Durotip Angle Wire Cutting Scissors	462
Derra Multi Purpose Clamps for Neonatales	317	Durotip Wire Cutting Forcpes	451,460
Derrico Bone Hand Drills	383	Duval Forceps	216
Deschamps Suture Instruments	132,133	Duval Intestinal Grasping Forceps	215
Desjardins Dilators & Scoops	259	Duval Lung Dissecting Forceps	83
Desjardins Dissecting and Ligature Forcep	105,113	Duval Multi-Purpose Clamps	347
Desjardins Gall Duct Forceps	245	Duval-Collin Intestinal Grasping Forceps	215
Desjardins Gall Duct Probes	258	E	
Desjardins Gall Stone Forceps	249	Echlin Bone Rongeurs	441
Desmarres Eye Retractor	544	Eiselsberg Ligature Scissor	47
Desmarres Retractor	159	Eiselsberg Needle Holder	129
Dick haemostatic Forceps	116	Eiselsberg-Mathieu Needle Holder	130
Dick Sigmoid Anastomosis Forceps	231	Elsasser Nephrostomy Forceps	252
Dick Vaginal and Compression Forceps	109	Elsching Delicate Tissue Forceps	79,542
Dieffenbach Tenotomes	10	Emmet Retractor	158
Dieffnbach Bulldog Clamps	354	Emmet Sponge & Dressing Forcep	118
Dieter Micro Ear Forceps	503	Endarterectomy Super Cut Scissor	65
Diethrich Aorta Clamp	337	Endarterectomy Strippers Nerve Hooklets	359
Diethrich Needle Holder with TC	138	Endo Tray Box	576
Diethrich Vascular TC Scissor	59	Endodontic Box	576
Diethrich Vessel Scissors	28	Engl.Mod. Towel Clamp Forceps	123
Diethrich-Hegemann Vascular TC Scissor	60	Eppendorf Biopsy Forcep	283,285,287
Dingmann Mouth Gags	529	Esmarch Universal & Bandage scissor	51
Dingmann Repositioning, Bone Holding Forceps	408	Eves Tonsil Snare	523
Director Probe	147	Extension Bone Hand Drills	383
Dissecting Knives	9	Extraction Pliers	447
Distraction Pin A/B Brain Retractors	489	F	
Distraction Pin A/B Retractors for Cervical Vertebral Column	488	Farabeuf Bone Holding Forceps	412
Dittle Dilators & Scoops	259	Farabeuf Raspatories	397
Doyen Abdominal Retractors	181,185	Farabeuf Retractor	160
Doyen Dissecting Scissor	23		
Doyen Intestinal Clamps	220,221,222		



 Noal More, Roras Road,
Sialkot 51310 - Pakistan.

 0092 323 4303862

 0092 323 4303862

 info@caremedical.com.pk

 www.caremedical.com.pk



cGMP



ISO:9001:2015
ISO:13485:2016