



**CARE MEDICAL**  
SUPPLIES

*" Your Health Our Priority "*

**OPHTHALMIC**  
INSTRUMENTS  
CATALOGUE



## Company Profile

We have the honor to present our website catalogue of Surgical Instruments, Dental Instruments, Ophthalmic Instruments and Holloware for your perusal reference.

We take this opportunity to introduce our self as CARE MEDICAL SUPPLIES is leading Manufacturers & Exporters of all type of Surgical, Dental, Ophthalmic Instruments & Holloware. We are running our business very successfully from last one decade and growing day by day with our excellent quality products and customer satisfaction approach. The company manufactures over 6000 products and is dedicated to provide supreme quality and service. All our administration and sales staff are highly trained, which enables us to continuously monitor and achieve complete customer satisfaction.

### **QUALITY ACHIEVEMENTS:**

It is added that our company is also holder of certificates of international quality standards such as ISO-9001:2000, cGMP & CE Mark, which reflects the quality service of our instruments. We are interested not only to sale our products but also build a good and long-term relationship with our customers.

### **QUALITY POLICY:**

CARE MEDICAL SUPPLIES is guaranteed for quality instruments. We have better workmanship and correct design. Products are tested at each stage of manufacturing to last stage of packing / dispatch to ensure proper working of the instruments. We at CARE MEDICAL SUPPLIES has an endeavor to increase market share and are committed to continually improve the effectiveness of quality management systems of our instruments by meeting the requirements of our customers. Throughout manufacturing we maintain complete traceability for all materials used. We therefore feel that our quality system is very effective and it helps us to maintain our tradition of only Producing Quality Products.

### **OUR MISSION:**

Our mission is to provide premium quality, value and innovation to our customers in order for them to achieve maximum return on their investment. we try to achieve by utilizing effective corporate practices, efcient teamwork and synergetic organization culture. each individual in our team shall work towards total quality culture aiming for customer satisfaction.

CM-2201-R Small  
CM-2202-R Large  
Barraquer  
Wire Speculum  
with solid blades



CM-2203-R Small  
CM-2204-R Large  
CM-2205-R Large Heavy Wire  
Barraquer  
Wire Speculum

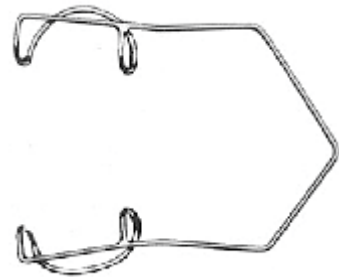

CM-2206-R Heavy Wire Large  
CM-2207-R Standard Wire Large  
CM-2208-R Standard Wire Small  
Kartz-Barraquer  
Wire Speculum  
with open blades for unobstructed access to  
the cataract incision with phaco or I/A tip

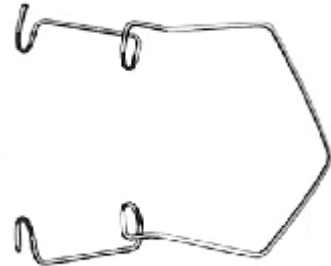

CM-2209-R Small  
CM-2210-R Large  
CM-2211-R Large Heavy Wire  
Barraquer  
Wire Speculum



CM-2212-R Solid Small # 1  
 CM-2213-R Solid Medium # 2  
 CM-2214-R Solid Large # 3  
 CM-2215-R Fenestrated Medium # 2  
 CM-2216-R Fenestrated Large # 3  
 Cook  
 Eye Speculum With locking screw

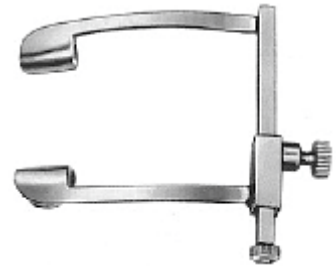

CM-2217-R For Infants  
 CM-2218-R For Premature Infants  
 Sauer  
 Lid Speculum



CM-2219-R  
 Liebermann Tennant  
 Eye Speculum  
 Fenestrated Open blades  
 for temporal placement

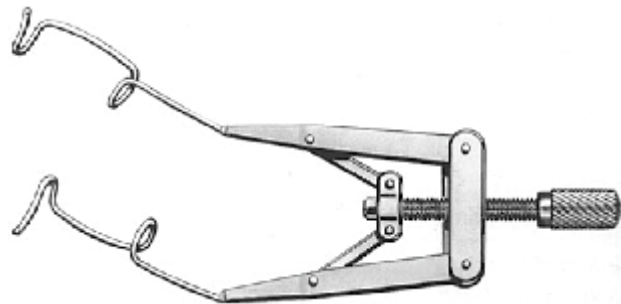

CM-2220-R  
 Knorz  
 Lasik Eye Speculum  
 with aspiration

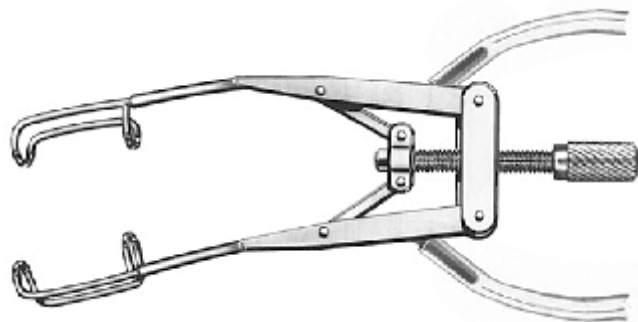

CM-2301-R Size 0, 1.5 mm dia  
CM-2302-R Size 1, 1.75 mm dia  
CM-2303-R Size 2, 2.2 mm dia  
CM-2304-R Size 3, 2.5 mm dia  
CM-2305-R Size 4, 3.5 mm dia  
Meyerhoefer  
Chalazion Curette

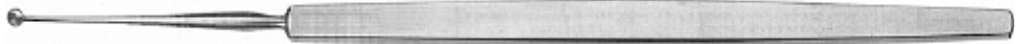

CM-2306-R Size 1  
CM-2307-R Size 2  
CM-2308-R Size 3  
Graefe  
Muscle Hook



CM-2309-R  
Keener Arit  
Lans Loop  
3 mm wide Serrated  
Strong curve for small incision nucleus  
fragment removal



CM-2310-R Small  
CM-2311-R Large  
Lewis  
Lens Loop



CM-2312-R Size 0  
CM-2313-R Size 1  
CM-2314-R Size 2  
CM-2315-R Size 3  
Desmarres  
Lid Retractor  
Solid Blade



CM-2216-R  
Schocket  
Scleral Depressor  
Double end  
with pocket clip



CM-2317-R  
Punctum  
Dilator  
Nettleships



CM-2318-R Size 0000/000  
CM-2319-R Size 00 / 0  
CM-2320-R Size 1/2  
CM-2321-R Size 3/4  
CM-2322-R Size 5/6  
Bowman  
Lacrimal Probe  
Cylindrical



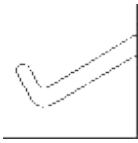

CM-2401-R Straight with guard  
CM-2402-R Angled  
Sinsky  
Lens Manipulating Hook with round handle  
0.25 mm dia Blunt tip

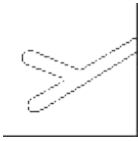

CM-2403-R Straight with guard  
CM-2404-R Angled  
Maltzman-Fenzi  
Lens Manipulating Hook  
0.15 mm dia v-Shaped tip Round handle  
CM-2405-R  
Lens Manipulating Hook Angled



CM-2406-R  
Nagahara  
Nucleus Dividing Hook

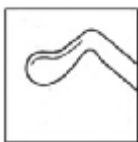

CM-2407-R Right Hand  
CM-2408-R Left Hand  
Liebermann  
Microfinger  
Nucleus Manipulator





CM-2409-R  
Drysdale  
Nucleus Manipulator  
and Anterior Capsule Polisher



CM-2410- Straight  
CM-2411- Angled  
Kuglen  
Iris Hook  
and lens Manipulator  
Push-Pull Model

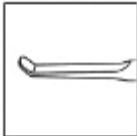

CM-2412  
Membrane Spatule  
1.5 mm Angled  
20 gauge / 0.9 mm

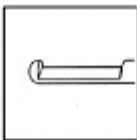

CM-2413-R  
Membrane Peeler  
Blunt with Peeling Edges  
20 gauge / 0.9 mm





CM-2501-R  
Thomas Neuhann  
Corneal Marker  
6 Blades Inside Diameter 3.0 mm  
Outside Diameter 12.0 mm



CM-2502-R 8.0 mm  
CM-2503-R 9.5 mm  
Lasek Trephine  
With Crosshairs



CM-2504-R  
Clear Cornea Incision Fixation Ring  
Inside Diameter 16.0 mm  
Swivelable 12 Teeth



CM-2505-R  
Clear Cornea Incision Fixation Ring  
Inside Diameter 13.0 mm  
9 Teeth





CM-2506-R 15 mm  
Castroviejo  
Marking Caliper

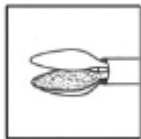

CM-2507- R  
Vitrectomy Forceps  
Straight Silicone Coated Tips  
20 gauge / 0.9 mm



CM-2508-R  
Vitrectomy Membrane Peeler Forceps  
45° angled  
20 gauge / 0.9 mm

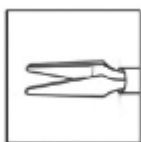

CM-2509-R  
Vitrectomy Forceps  
Straight Silicone Coated Tips  
20 gauge / 0.9 mm





CM-2601-R  
n. Inamura  
Capsulorhexis Forceps



CM-2602-R  
Ultrata  
Capsulorhexis Forceps  
Very delicate grasping tips and extremely thin 11 mm  
long shanks, with guide pin



CM-2603-R  
Masket  
Capsulorhexis Forceps  
Very delicate grasping tips and extremely thin 11 mm  
Corved Tip long Vaulted shanks



CM-2604-R  
Nevyas  
Capsulorhexis Forceps  
Extremely thin 11 mm long Shanks  
Cystotome Shaped Tips for Penetrating and Grasping  
Anterior Capsule





**CM-2605-R**  
Haberle-McPherson  
Lens Holding Forceps  
angled, very delicate 7.5 mm long smooth jaws  
with diagonal groove inside tips

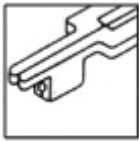

**CM-2606-R**  
Folding Forceps  
Paddle Style Jaws  
Stop in handle Design Prevent "Over Folding"  
Standard Long Handle Length 110.0 mm  
Designed Sprcifically For AcrySof



**CM-2607-R**  
Iol Holding Insertion Forceps  
10.0 mm Curved Jaws  
30° Angled Shafts Tip to Angle Length 15.0 mm

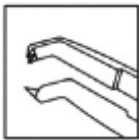

**CM-2608-R**  
Colibri  
Forceps Standard  
1x2 teeth, 0.4 mm  
with Trying Platform



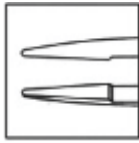

**CM-2701-R**  
Tuebingen Model  
Tying Forceps  
Straight



**CM-2702-R**  
Tuebingen Model  
Tying Forceps  
Curved

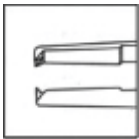

**CM-2703-R**  
Bone Model  
Iris Forceps  
Long, Straight 1 x 2 Teeth, With tying Platform

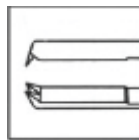

**CM-2704-R 0.12 mm**  
**CM-2705-R 0.3 mm**  
**CM-2706-R 0.5 mm**  
**CM-2707-R 0.9 mm**  
**CM-2708-R 1.2 mm**  
Castroviejo  
Suturing Forceps, New Model Straight With Tying Platform



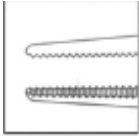

CM-2709-R  
Iris Forceps  
Straight Serrated

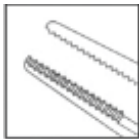

CM-2710-R  
Iris Forceps  
Angled, 6.0 mm serrated



CM-2711-R  
Iris Forceps  
Curved Serrated

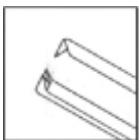

CM-2712-R  
Iris Forceps  
Bone Model  
Angled, 8.0 mm 1 x 2 Teeth





**CM-2801-R**  
Clayman  
Lens Holding Forceps  
delicate angled jaws  
gently curved shanks without lock



**CM-2802-R**  
Blaydes  
Lens Holding Forceps  
very delicate angled 45°  
narrow smooth jaws



**CM-2803-R**  
Lambert  
Chalazion forceps  
round, 8 mm diameter



**CM-2804-R 20 mm**  
**CM-2805-R 25 mm**  
**CM-2806-R 30 mm**  
Francis  
Chalazion forceps  
oval, Medium





CM-2807-R 0.5 mm  
 CM-2808-R 0.7 mm  
 CM-2809-R 1.0 mm  
 CM-2810-R 1.2 mm  
 CM-2811-R 1.4 mm  
 Dressing Forceps 1 x 2 Teeth

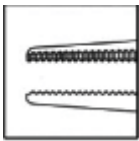

CM-2812-R 0.5 mm  
 CM-2813-R 0.7 mm  
 CM-2814-R 1.0 mm  
 CM-2815-R 1.2 mm  
 CM-2816-R 1.4 mm  
 Dressing forceps  
 Serrated

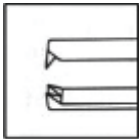

CM-2817-R  
 Kaufmann  
 Conjunctive forceps  
 with tying platform

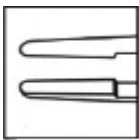

CM-2818-R  
 St Martin  
 With Tying platform  
 0.7 mm



**CM-2901-R**  
Barraquer  
Needle Holder Micro  
Curved without lock  
Jaw 0.55 mm  
Handle 8.0 mm  
Total Length 120 mm



**CM-2902-R**  
Barraquer  
Needle Holder Micro  
Curved without lock  
Jaw 0.55 mm  
Handle 8.0 mm  
Total Length 120 mm



**CM-2903-R**  
Castroviejo  
Needle Holder  
Straight With lock  
Total Length 140 mm



**CM-2904-R**  
Castroviejo  
Needle Holder  
Straight With lock  
Total Length 140 mm



CM-2905-R  
Kalt  
Straight

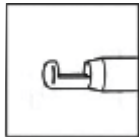

CM-2906-R  
Kalt  
Glaucoma punch  
0.9 x 0.45 mm

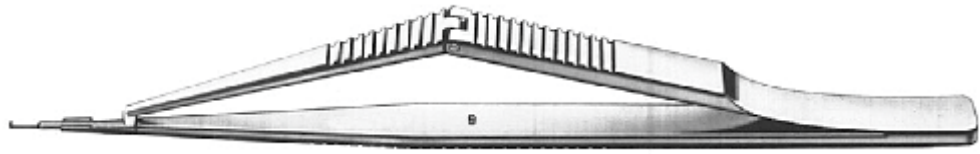

CM-2907-R  
Barraquer  
Razor Blade Holder  
Total Length 110mm



CM-2908-R  
Troutman  
Razor Blade Holder  
Strsight, Handel 5.5 mm  
Total Length 95mm



**CM-3001-R**  
Tuebingen Model  
Vannas Scissors  
Curved 8 mm



**CM-3002-R**  
Corneal Scissors  
light Curve  
Universal  
Blunt Tip 1 cm



**CM-3003-R 9 mm blade**  
**CM-3004-R 11 mm blade**  
Capsulotomy Scissors  
Angled on Flat 8 cm



**CM-3005-R**  
Barraquer  
Dewecker Scissors  
7 mm Blade  
Blunt Blunt



CM-3006-R Blunt 12 cm  
CM-3007-R Pointed 12 cm  
Westcott  
Scissors



CM-3008-R  
Scissors  
Straight  
Pointed 11 cm



CM-3009-R  
Scissors  
Light Curve  
Pointed 10 cm



CM-3010-R  
Bone Model  
Eyes Scissors  
Curved Extremely Delicate  
9 cm



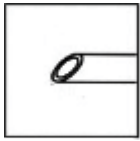

CM-3101-R 4.0 mm  
CM-3102-R 5.0 mm  
CM-3103-R 6.0 mm  
CM-3104-R 7.0 mm

Infusion Tubing  
Declined  
20 gauge / 0.9 mm  
Silicone Tube 40 cm  
Luer-Lock Synthetic Adapter



CM-3105-R  
Nagata  
Sub Tenon Injection Cannula  
24 Gauge / 0.60 mm

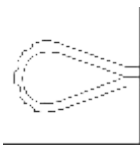

CM-3106-R  
Irrigating Vectis  
Cannula



CM-3107-R  
Zirm  
Lasik Dissector Cannula  
25 Gauge / 0.5 mm





**CM-3108-R**  
Simcoe  
Irrigating / Aspirating Cannula  
Irrigating and Aspirating Tube  
23 Gauge / 0.64 mm each



**CM-3109-R**  
Irrigating / Aspirating Cannula  
J Shape  
Irrigating and Aspirating tube  
23 Gauge / 0.64 mm each



**CM-3110-R**  
Irrigating Cannula  
with bulbous tip  
Extremely Delicate



**CM-3111-R**  
Sautter  
Hydrodissection Cannula  
26 Gauge / 0.45 mm



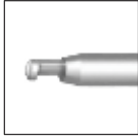

**CM-3201-R**  
Gass  
Corneoscleral Punch  
1.5 mm diameter head  
0.75 mm deep bite  
rotatable tip for convenient positioning

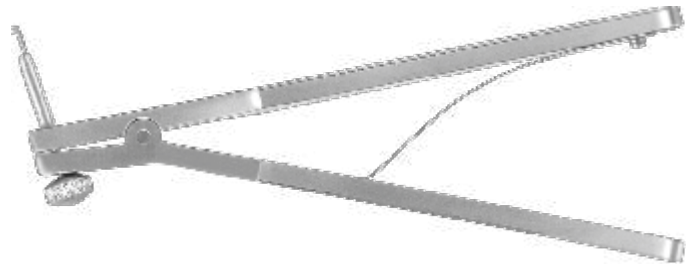

**CM-3202-R**  
Irrigating / Aspirating Cannula  
J Shape  
Irrigating and Aspirating tube  
23 Gauge / 0.64 mm each

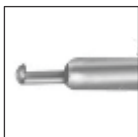
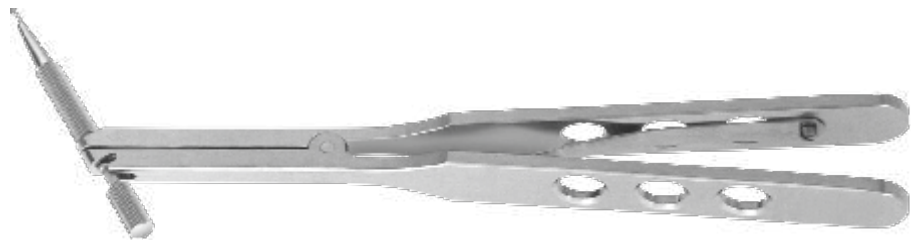

**CM-3203-R**  
Kelly  
Descemet's Membrane Punch  
1.0 mm diameter head  
0.75 mm deep bite

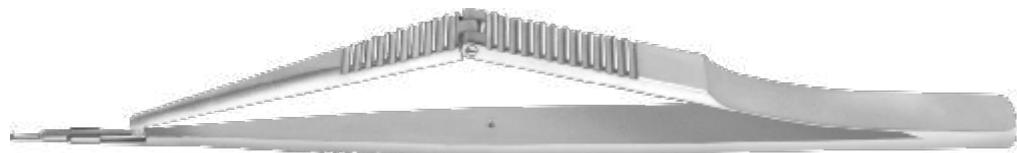

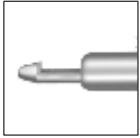

**CM-3204**  
Fukasaku  
Micro Trabeculectomy Punch  
0.6 mm diameter head  
with bullet shaped tip  
0.3 mm x 0.6 mm deep bit



**CM-3205-R**  
Christensen  
Punctum Punch  
1 mm wide bite  
For opening stenotic punctums.

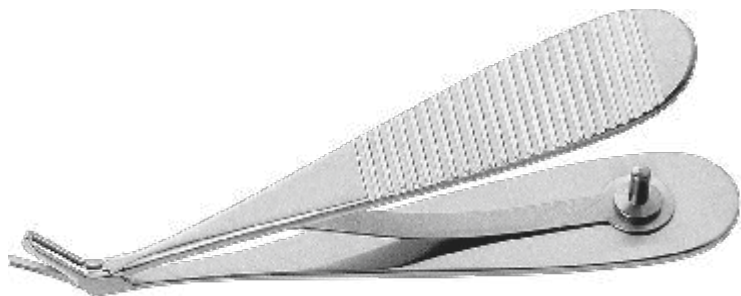

CM-3301 for one knife  
 CM-3302 for two knives  
 Sterilizing Case for Diamond Knife  
 autoclavable plastic  
 with perforated silicone rack

Millimeters                  Inches  
 160 x 60 x 25              6 1/4" x 2 1/4" x 1"

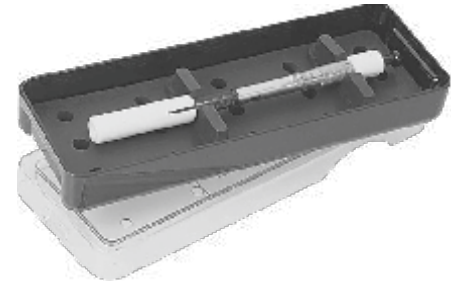

Plastic Sterilizing Cases  
 autoclavable plastic  
 with silicone finger mat  
 base, lid and mat are perforated  
 for steam penetration

| Catalog # | Size                | # of Instruments | Millimeters    | Inches                |
|-----------|---------------------|------------------|----------------|-----------------------|
| CM-3303   | Small, Narrow       | 1-2              | 195 x 60 x 25  | 7 5/8" x 2 1/4" x 1"  |
| CM-3304   | Small               | 2-3              | 160 x 70 x 25  | 6 1/4" x 2 3/4" x 1"  |
| CM-3305   | Medium              | 4-6              | 200 x 110 x 25 | 6 3/4" x 4 1/4" x 1"  |
| CM-3306   | Large               | 10-15            | 265 x 160 x 25 | 10 3/8" x 6 3/8" x 1" |
| CM-3307   | Large, Double Level | 20-25            | 265 x 160 x 50 | 10 3/8" x 6 3/8" x 2" |

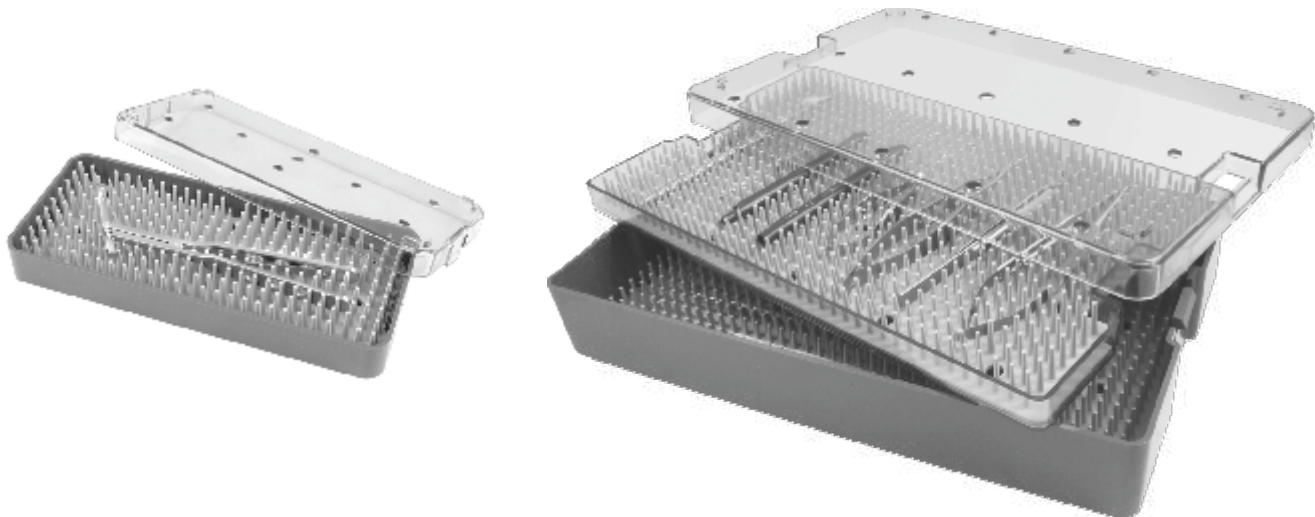

CM-3320 Complete  
CM-3321 Silicone mat only  
Katena Sterilizing Case, small  
stainless steel  
base, lid and mat are perforated  
for steam penetration  
Accommodates 8 to 12  
microsurgical Instruments.

|                |                    |
|----------------|--------------------|
| Millimeters    | Inches             |
| 210 x 125 x 20 | 8 1/4" x 5" x 3/4" |



CM-3322  
Katena Sterilizing Case, medium  
stainless steel  
base, lid and mat are perforated  
for steam penetration  
includes 2 silicone mats, rack for  
4 cannulas and a rack for 4 delicate  
hooks or knives  
Accommodates 20 to 25  
microsurgical Instruments.

|                |                         |
|----------------|-------------------------|
| Millimeters    | Inches                  |
| 320 x 220 x 20 | 12 1/2" x 8 3/4" x 3/4" |

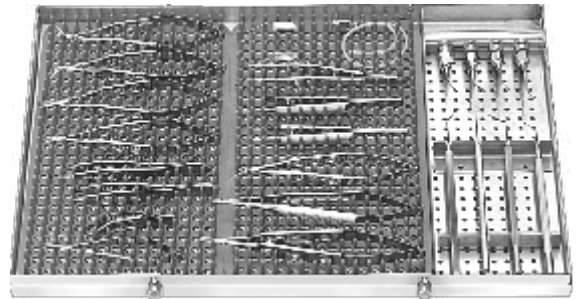

CM-3323  
Katena Sterilizing Case, large  
stainless steel  
base, lid and mat are perforated  
for steam penetration  
includes 3 silicone mats, racks for  
8 cannulas and a rack for 4 delicate  
hooks or knives  
Accommodates 30 to 40  
microsurgical Instruments.

|                |                          |
|----------------|--------------------------|
| Millimeters    | Inches                   |
| 360 x 295 x 20 | 14 1/4" x 11 1/2" x 3/4" |

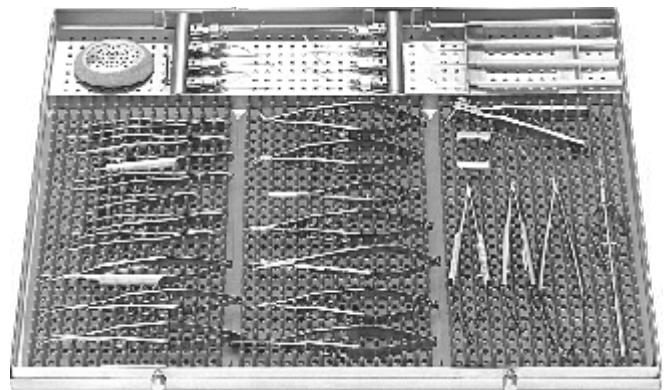

| Instrument Sets |  | Page Number |
|-----------------|--|-------------|
| CM-3400         | PLANNED EXTRA-CAPSULAR CATARACT EXTRACTION                   | 212         |
| CM-3500         | FEMTO CATARACT SET   | 213         |
| CM-3600         | CHANG CONTINGENCY SET  | 214         |
| CM-3700         | IOL EXPLANTATION SET   | 215         |
| CM-3800         | MICRO IOL REMOVAL SET  | 216         |
| CM-3900         | EXTRA-CAPSULAR CATARACT EXTRACTION SET (PHACOEMULSIFICATION) | 217         |
| CM-4000         | PHACO PRECHOP SET  | 218         |
| CM-4100         | MICRO INCISION CATARACT SURGERY (MICS) SET                   | 219         |
| CM-4200         | MANUAL PHACOFRACTURE CATARACT EXTRACTION SET                 | 220         |
| CM-4300         | MANUAL SMALL INCISION CATARACT SURGERY (MSICS) SET           | 221         |
| CM-4400         | LIMBAL RELAXING INCISION SET                                 | 222         |
| CM-4500         | TORIC IOL SET  | 223         |
| CM-4600         | GLAUCOMA SET   | 224         |
| CM-4700         | CORNEAL TRANSPLANT SET                                       | 225         |
| CM-4800         | DEEP ANTERIOR LAMELLAR KERATOPLASTY (DALK) SET               | 226         |
| CM-4900         | ENDOTHELIAL TRANSPLANTATION SET                              | 227         |
| CM-5000         | LASIK SET  | 228         |
| CM-5100         | FEMTOSECOND LASIK SET  | 229         |
| CM-5200         | LASEK SET  | 230         |
| CM-5300         | LID SET  | 231         |
| CM-5400         | OCULOPLASTIC SET   | 232         |
| CM-5500         | CHALAZION SET  | 233         |
| CM-5600         | STRABISMUS SET   | 234         |
| CM-5700         | LACRIMAL SET   | 235         |
| CM-5800         | VITREORETINAL SET  | 236         |
| CM-5900         | ENUCLEATION SET  | 237         |
| CM-6000         | PTERYGIUM SET  | 238         |
| CM-6100         | OFFICE SET   | 239         |
| CM-6200         | VETERINARY OPHTHALMIC SET                                    | 240         |

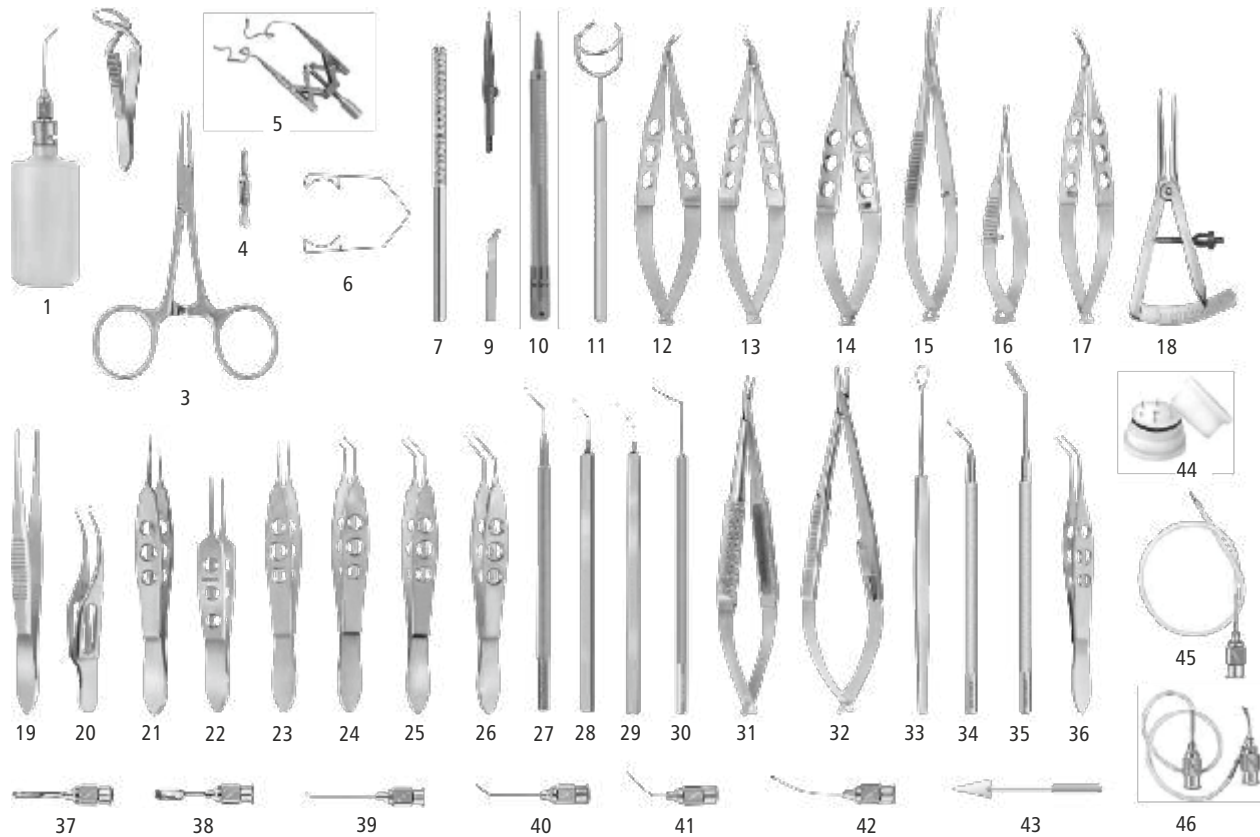

**CM-3400 • PLANNED EXTRA-CAPSULAR CATARACT EXTRACTION**

- |  |  |
|--|--|
| 1. CM-3401 Bishop-Harmon A/C Irrigator                 | 25. CM-3425 Kelman-McPherson Forceps                 |
| 2. CM-3402 Jones Towel Clamp                           | 26. CM-3426 Utrata Capsulorrhexis Forceps            |
| 3. CM-3403 Hartmann Mosquito Forceps, straight         | 27. CM-3427 Nagahara Phaco Chopper                   |
| 4. CM-3404 Serrefine, small, straight                  | 28. CM-3428 Sinsky II Lens Hook, angled              |
| 5. CM-3405 Double-X Speculum, K-wire, 15mm             | 29. CM-3429 Kuglen Iris Hook, angled                 |
| 6. CM-3406 Barraquer Wire Speculum, large              | 30. CM-3430 Barraquer Iris Spatula                   |
| 7. CM-3407 Chuck Handle (2)                            | 31. CM-3431 Barraquer Needle Holder, curved          |
| 8. CM-3408 Super Sharp Blade, 15 deg. (bx)             | 32. CM-3432 Castroviejo Needle Holder, straight      |
| 9. CM-3409 Lamellar Blade #66 (bx)                     | 33. CM-3433 Lewis Lens Loop                          |
| 10. CM-3410 Diamond Step Knife                         | 34. CM-3434 Alfonso Trisector, oval                  |
| 11. CM-3411 Fine-Thornton Fixation Ring, 13mm          | 35. CM-3435 Alfonso Cutting Platform                 |
| 12. CM-3412 Castroviejo Corneal Scissors, small, right | 36. CM-3436 Alfonso Nucleus Forceps                  |
| 13. CM-3413 Castroviejo Corneal Scissors, small, left  | 37. CM-3437 Alfonso-McIntyre Irrigating Spoon, small |
| 14. CM-3414 Westcott Tenotomy Scissors                 | 38. CM-3436 Alfonso-McIntyre Irrigating Spoon, large |
| 15. CM-3415 Westcott Stitch Scissors                   | 39. CM-3439 Anis Cortex Aspiration Cannula           |
| 16. CM-3416 Vannas Scissors, curved                    | 40. CM-3440 Air Injection Cannula, 27ga.             |
| 17. CM-3417 Stern-Gills Scissors                       | 41. CM-3441 McIntyre A/C Cannula, 26ga.              |
| 18. CM-3418 Castroviejo Caliper                        | 42. CM-3442 Jensen Polisher, 23ga.                   |
| 19. CM-3419 Bonaccolto Conjunctiva Forceps             | 43. CM-3443 K-Sponge Spears (bx)                     |
| 20. CM-3420 Harms-Colibri Forceps, 0.12mm              | 44. CM-3444 Iris Retractors, (set of 6) in case      |
| 21. CM-3421 Bonn Forceps, 0.12mm                       | 45. CM-3445 Brierley Chamber Maintainer              |
| 22. CM-3422 Bishop-Harmon Forceps                      | 46. CM-3446 Simcoe I/A Cannula, curved               |
| 23. CM-3423 McPherson Tying Forceps, straight          | 47. CM-3447 Sterilizing Case, double, aluminum       |
| 24. CM-3424 McPherson Tying Forceps, angled            |  |

\*not shown

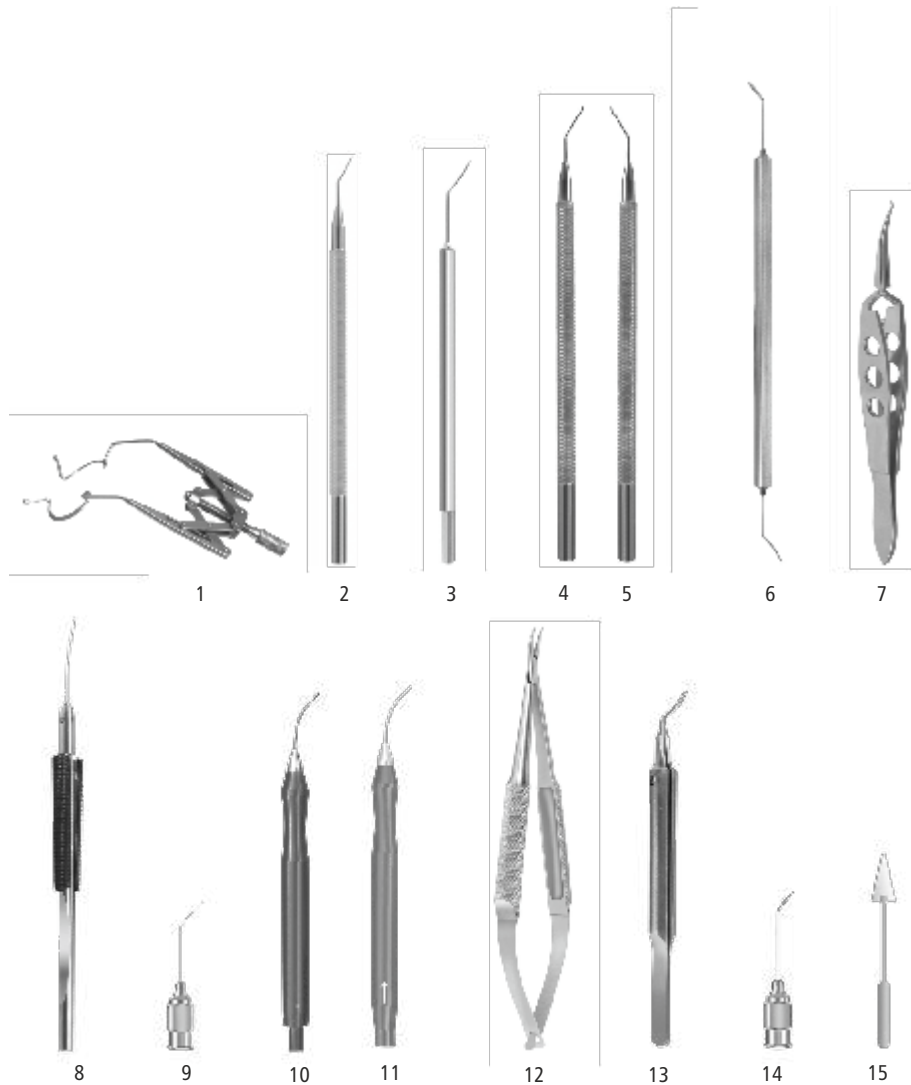

**CM-3500 • FEMTO CATARACT SET**

- |            |                                     |             |  |
|------------|-------------------------------------|-------------|--|
| 1. CM-3501 | Double-X Speculum, 13mm blades      | 9. CM-3509  | Chu Hydrodissection Cannula, 25ga.         |
| 2. CM-3502 | Donnenfeld Femto Spatula, spear tip | 10. CM-3510 | Aspiration Handpiece, 21ga. with texture   |
| 3. CM-3503 | Katena Femto Spatula, blunt tip     | 11. CM-3511 | Irrigation Handpiece, 21ga. dual 0.5 ports |
| 4. CM-3504 | Donnenfeld Femto Splitter, right    | 12. CM-3512 | Barraquer Needle Holder, curved            |
| 5. CM-3505 | Donnenfeld Femto Splitter, left     | 13. CM-3513 | Giannetti MICS Capsulorrhexis Forceps      |
| 6. CM-3506 | Katena Femto Spatula, D-E           | 14. CM-3514 | Air Injection Cannula, 27ga.               |
| 7. CM-3507 | Hu Femto Forceps                    | 15. CM-3515 | K-Sponge Spears (bx)                       |
| 8. CM-3508 | Femto Nucleus Forceps, 22ga.        | 16. CM-3516 | Sterilizing Case, large, aluminum          |
- \*not shown

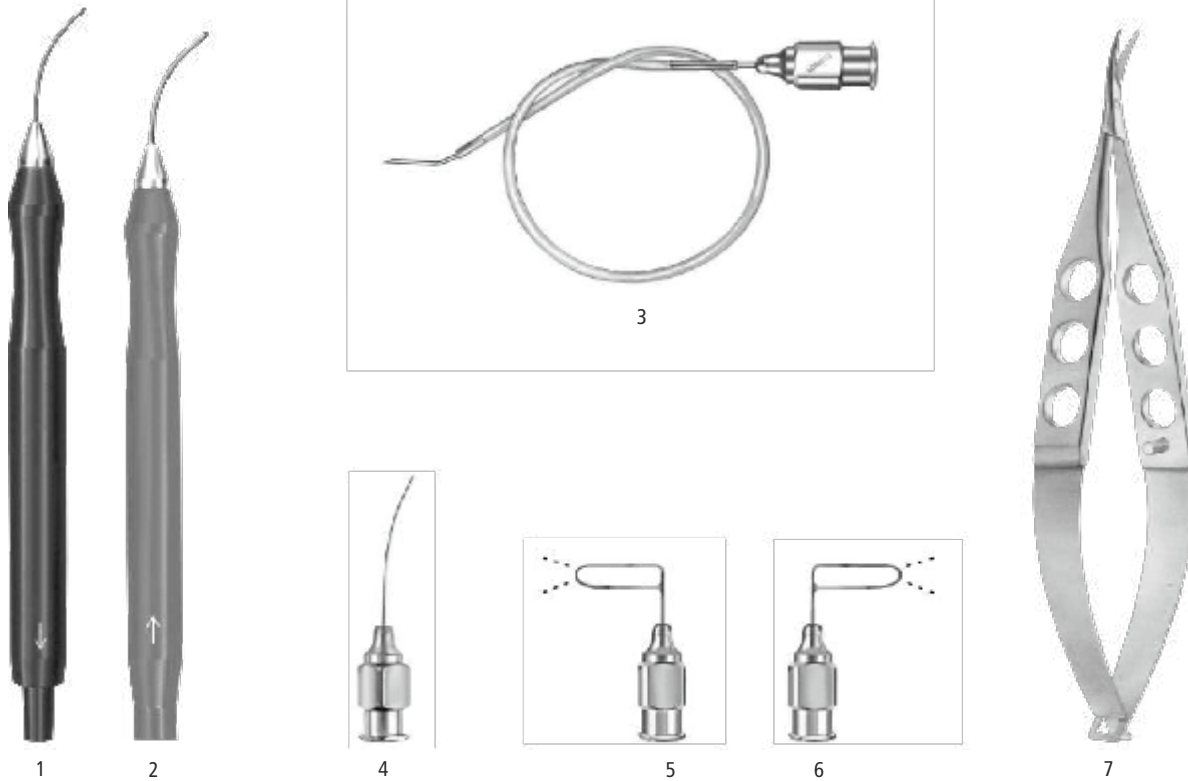

**CM-3600 • CHANG CONTINGENCY SET**

1. CM-3601 Aspiration Handpiece, 21 gauge, 0.35mm port, textured tip
2. CM-3602 Irrigation Handpiece, 21 gauge, dual 0.5mm ports
3. CM-3603 Infusion Cannula, 22 gauge, self retaining tip, with tubing and adaptor
4. CM-3604 Corbin Sub-Tenon's Cannula, 0.3 side port, 23 gauge
5. CM-3605 Simcoe Irrigating Lens Loop, two front ports, 25 gauge, right
6. CM-3606 Simcoe Irrigating Lens Loop, two front ports, 25 gauge, left
7. CM-3607 Castroviejo Corneal Scissors, curved, blunt tips, medium blades
8. CM-3608 Sterilizing Case, medium, plastic  
\*not shown

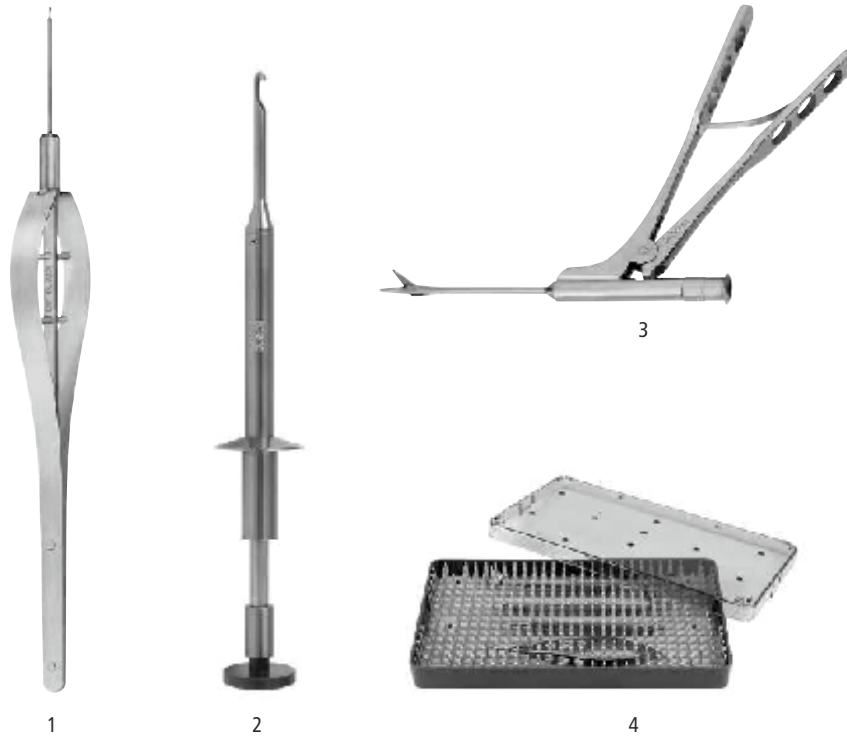

**CM-3700 • IOL EXPLANTATION SET**

1. CM-3701 Scimeca Haptic Cutter
2. CM-3702 Stolte IOL Cutter, titanium
3. CM-3703 Katena IOL Cutter
4. CM-3704 Sterilization Case, medium, plastic

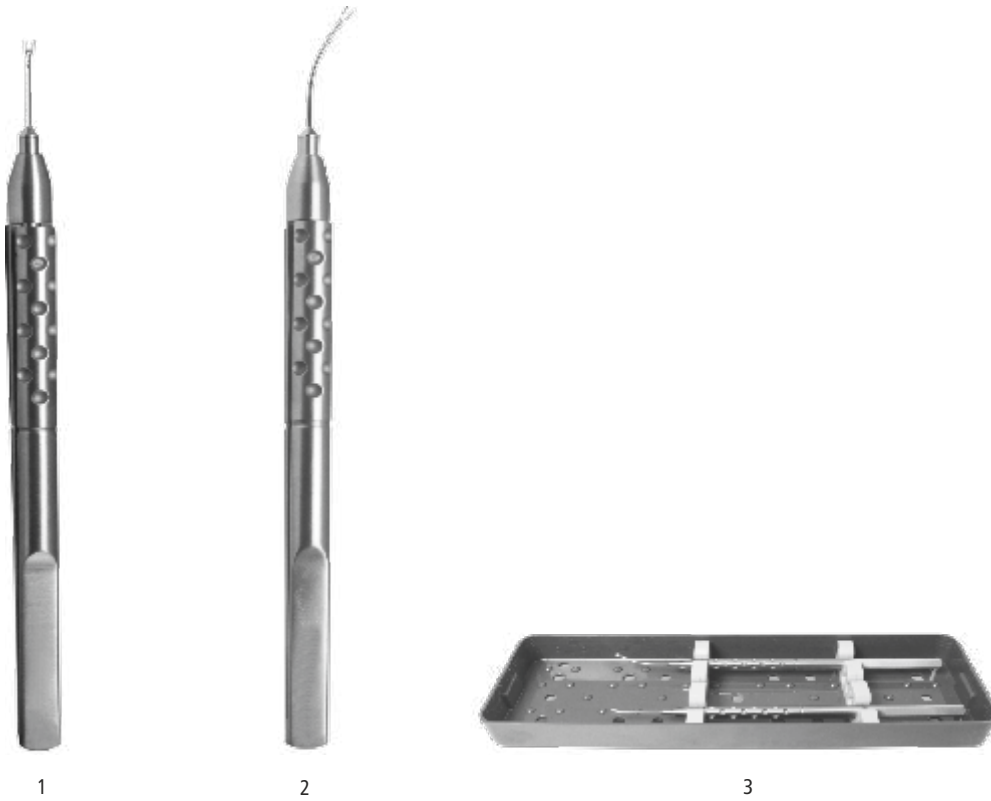

**CM-3800 • DONNENFELD MICRO IOL REMOVAL SET**

1. **CM-3801** Donnenfeld Micro Soft IOL Cutter
2. **CM-3802** Donnenfeld Micro IOL Holding Forceps
3. **CM-3803** Sterilizing Case, plastic, 3-instruments

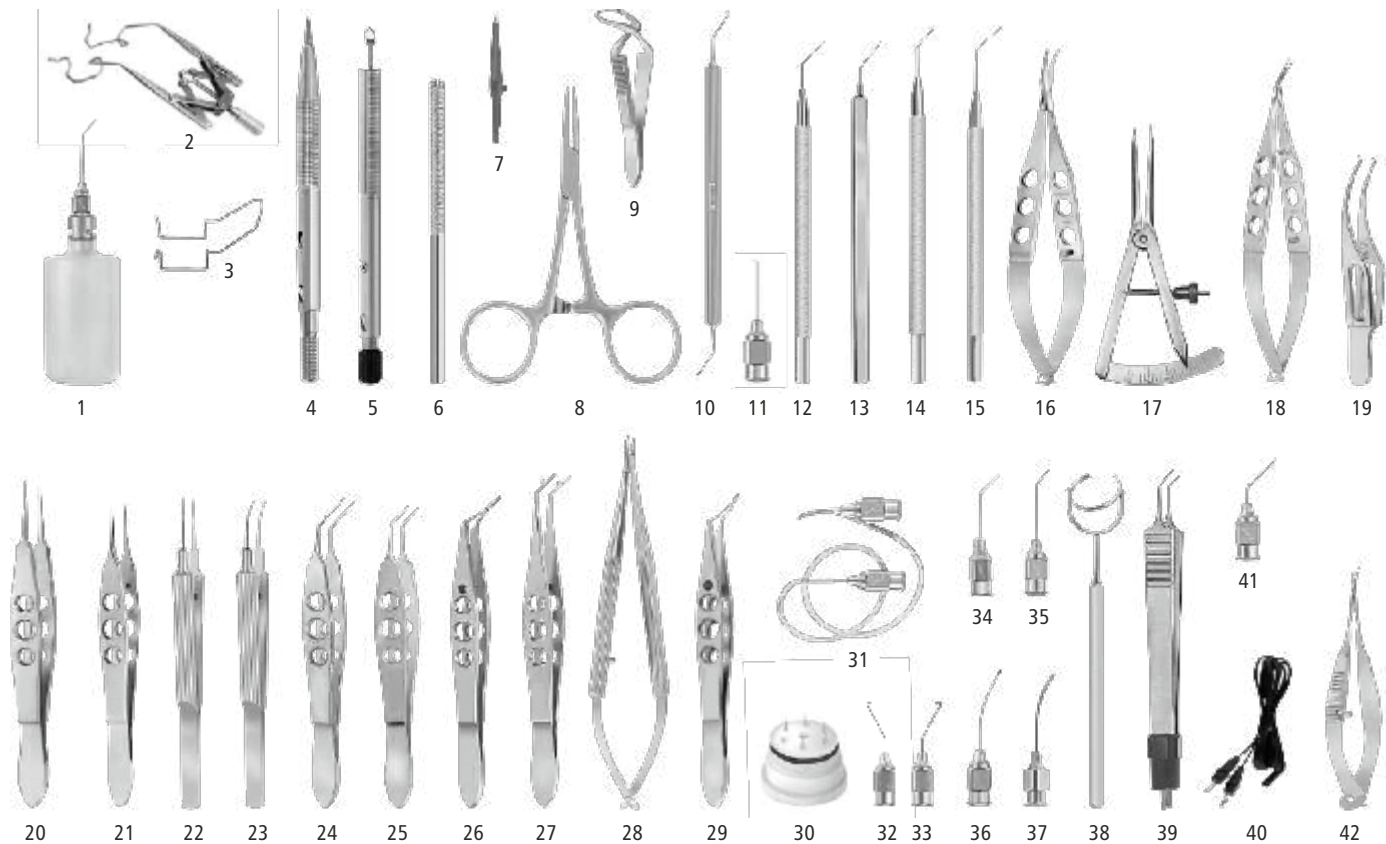

**CM-3900 • EXTRA-CAPSULAR CATARACT EXTRACTION USING PHACOEMULSIFICATION SET**

- |             |                                      |             |                                      |
|-------------|--------------------------------------|-------------|--------------------------------------|
| 1. CM-3901  | Bishop-Harmon A/C Irrigator          | 23. CM-3923 | Tennant Tying Forceps, curved        |
| 2. CM-3902  | Double-X Speculum, V-Wire, 15mm      | 24. CM-3924 | Utrata Capsulorrhexis Forceps        |
| 3. CM-3903  | Temporal Speculum, open wire         | 25. CM-3925 | Kelman-McPherson Forceps, angled     |
| 4. CM-3904  | Diamond Knife, tri-facet             | 26. CM-3926 | Ernest-McDonald IOL Inserter         |
| 5. CM-3905  | Phaco-4 Diamond Knife, 2.8mm, angled | 27. CM-3927 | Livernois IOL Folder                 |
| 6. CM-3906  | Chuck Handle                         | 28. CM-3928 | Katena Needle Holder, curved, w/lock |
| 7. CM-3907  | Super Sharp Blade, 15 deg. (bx)      | 29. CM-3929 | Ernest Nucleus Cracker               |
| 8. CM-3908  | Hartmann Mosquito Forceps, str.      | 30. CM-3930 | Iris Retractors, (set 6) in case     |
| 9. CM-3909  | Jones Towel Clamp                    | 31. CM-3931 | Simcoe I/A Cannula, curved           |
| 10. CM-3910 | Chang Combination Chopper, left      | 32. CM-3932 | McIntyre-Binkhorst Cannula, right    |
| 11. CM-3911 | Chang Hydrodissection Cannula, 27ga. | 33. CM-3933 | McIntyre-Binkhorst Cannula, left     |
| 12. CM-3912 | Rosen Phaco Splitter                 | 34. CM-3934 | Hydrodissection Cannula, 25ga.       |
| 13. CM-3913 | Kuglen Iris Hook, angled             | 35. CM-3935 | Air Injection Cannula, 27ga.         |
| 14. CM-3914 | Jaffe-Bechert Rotator, 9mm           | 36. CM-3936 | Jensen Polisher, 23ga.               |
| 15. CM-3915 | Lester IOL Manipulator, angled       | 37. CM-3937 | Stevens Sub-Tenon's Cannula, 19ga.   |
| 16. CM-3916 | Westcott Tenotomy Scissors           | 38. CM-3938 | Fine-Thornton Fixation Ring, 13mm    |
| 17. CM-3917 | Castroviejo Caliper, straight        | 39. CM-3939 | Bipolar Forceps, angled, blunt       |
| 18. CM-3918 | Stern-Gills Scissors                 | 40. CM-3940 | Bipolar Cord                         |
| 19. CM-3919 | Colibri Forceps, 0.12mm teeth        | 41. CM-3941 | McIntyre Reverse Cystotome           |
| 20. CM-3920 | Castroviejo Forceps, 0.12mm          | 42. CM-3942 | Vannas Scissors, curved              |
| 21. CM-3921 | Fechtner Conjunctiva Forceps         | 43. CM-3943 | K-Sponge Spears                      |
| 22. CM-3922 | Tennant Tying Forceps, straight      | 44. CM-3944 | Sterilizing Case, double, aluminum   |

\*not shown

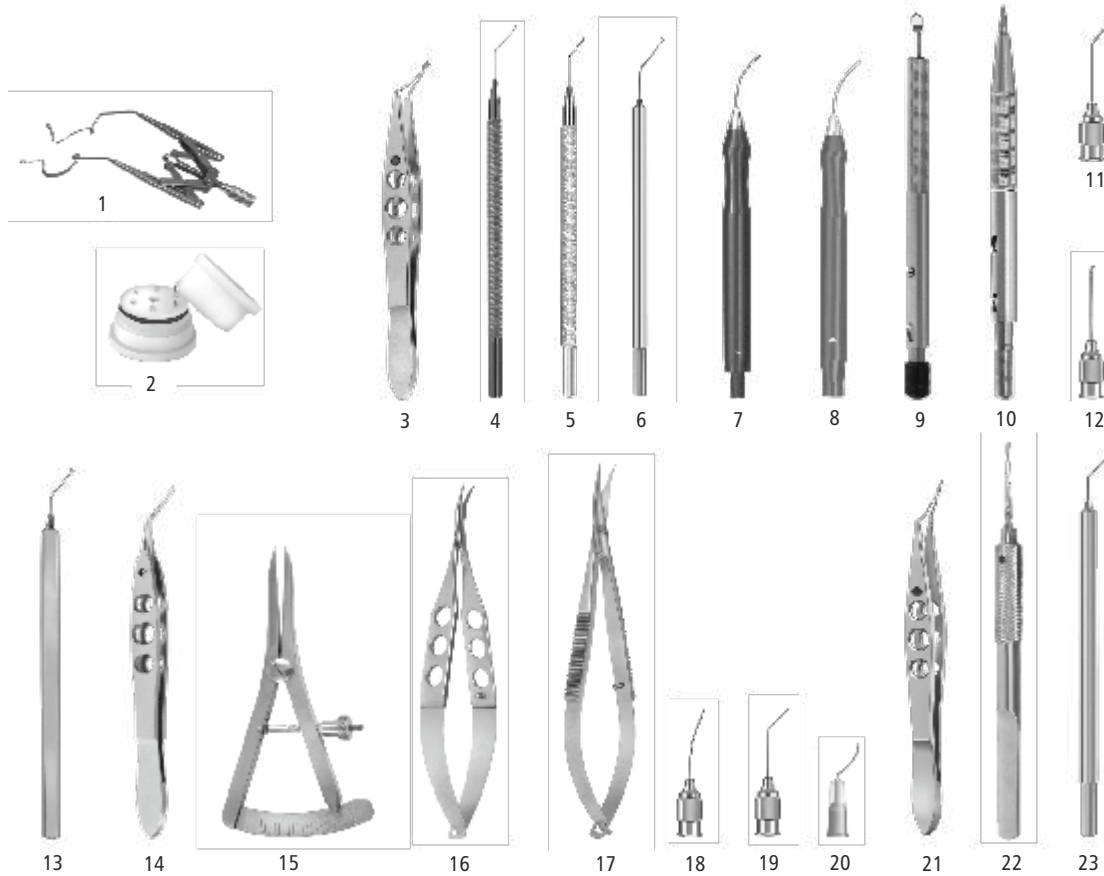

**CM-4000 • PHACO PRECHOP SET**

- |             |  |             |                                       |
|-------------|--|-------------|---------------------------------------|
| 1. CM-4001  | Double-X Speculum, 13mm blades                   | 13. CM-4013 | Kuglen Hook, angled                   |
| 2. CM-4002  | Iris Retractors (set 6) in case                  | 14. CM-4014 | Utrata MICS Capsulorrhexis Forceps    |
| 3. CM-4003  | Ernest Micro Nucleus Cracker                     | 15. CM-4015 | Castroviejo Caliper, straight         |
| 4. CM-4004  | Sinsky II Lens Manipulator                       | 16. CM-4016 | Westcott Tenotomy Scissors            |
| 5. CM-4005  | Jaffe-Bechert Nucleus Rotator                    | 17. CM-4017 | Westcott Stitch Scissors              |
| 6. CM-4006  | Dodick-Kammann Chopper 1.5mm, angled (x2)        | 18. CM-4018 | Sauter Hydrodissection Cannula, 27ga. |
| 7. CM-4007  | Aspiration Handpiece, 21ga. w/ textured tip      | 19. CM-4019 | Hydrodissection Cannula, 25ga.        |
| 8. CM-4008  | Irrigation Handpiece, 21ga. dual 0.5mm sideports | 20. CM-4020 | Cystotome, formed, 25ga. (bx/10)      |
| 9. CM-4009  | Phaco-4 Diamond Knife, 2.8mm, angled             | 21. CM-4021 | Akahoshi Phaco PreChopper             |
| 10. CM-4010 | Diamond Knife, tri-facet, 1mm                    | 22. CM-4022 | Akahoshi Combo PreChopper             |
| 11. CM-4011 | Air Injection Cannula, 30ga.                     | 23. CM-4023 | Akahoshi Nucleus Sustainer            |
| 12. CM-4012 | Kratz Scratcher, 22ga.                           | 24. CM-4024 | Instrument Case, large, aluminum      |

\*not shown

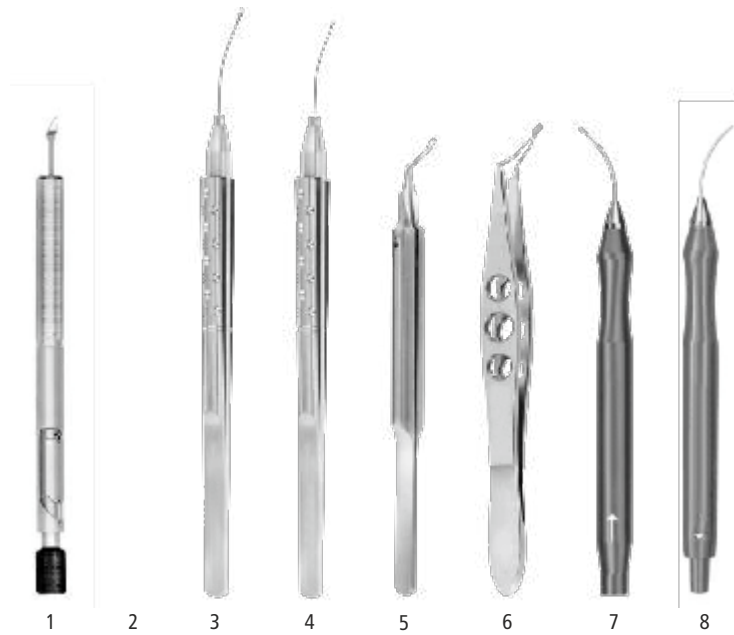

**CM-4100 • MICRO INCISION CATARACT SURGERY (MICS) SET**

1. CM-4101 MICS Diamond Knife Trapezoid, 1.8/2.2mm
  2. CM-4102 Alio-Kelman IOL Hook
  3. CM-4103 Alio MICS Scissors, 23ga.
  4. CM-4104 Alio MICS Capsulorrhexis Forceps, 23ga.
  5. CM-4105 Giannetti MICS Capsulorrhexis Forceps
  6. CM-4106 Ernest Micro Nucleus Cracker
  7. CM-4107 Irrigating Handpiece, 23ga., dual 0.3mm ports
  8. CM-4108 Aspirating Handpiece, 0.3mm, with textured tip
  9. CM-4109 Instrument Case, medium, aluminum
- \*not shown

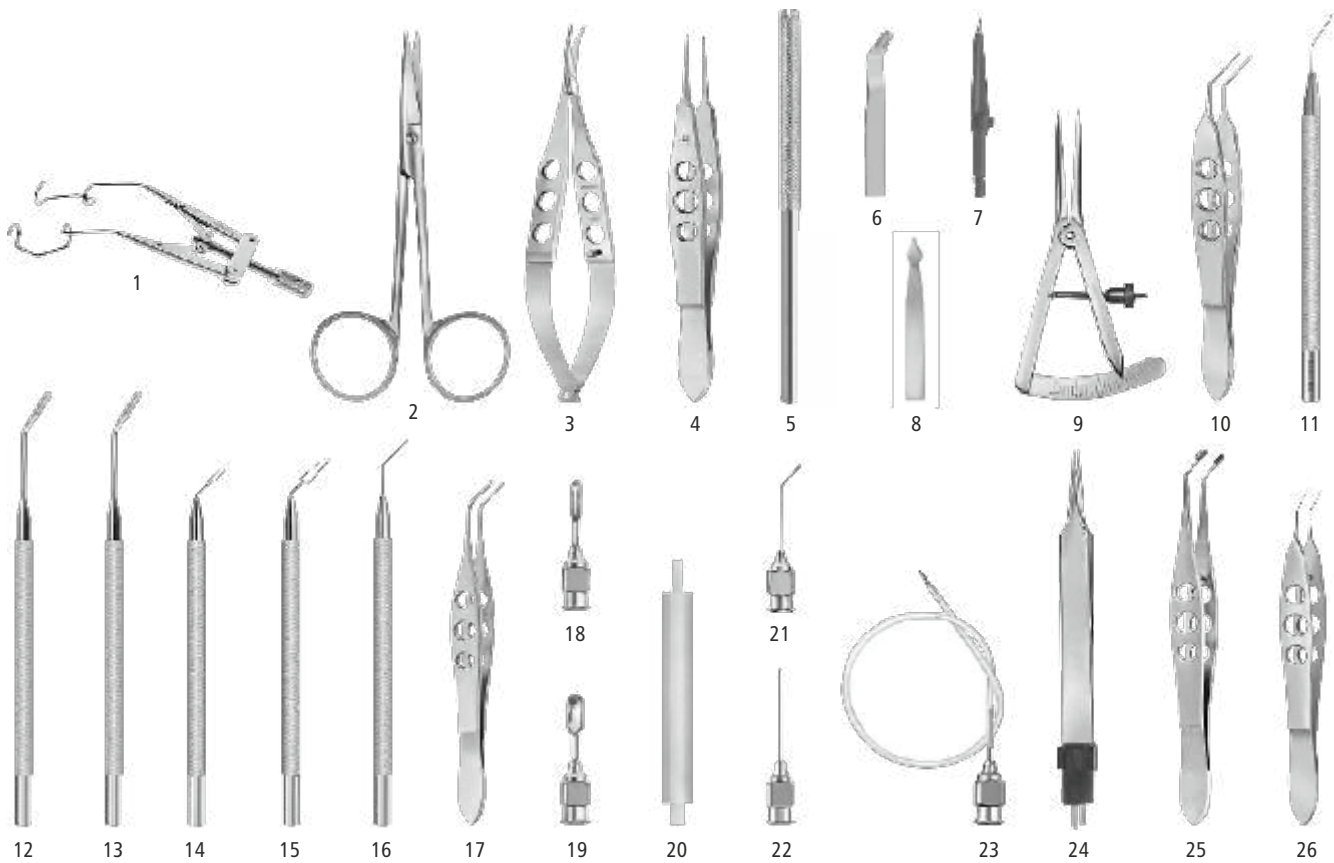

**CM-4200 • MANUAL PHACOFRACTURE CATARACT EXTRACTION SET**  
as used by Eduardo Alfonso, M.D.

- |             |                                     |             |  |
|-------------|-------------------------------------|-------------|--|
| 1. CM-4201  | Lieberman Speculum, V-wire          | 15. CM-4215 | Bucher-Kansas Nucleus Trisector          |
| 2. CM-4202  | Eye Scissors, straight              | 16. CM-4216 | Kansas Nucleus Bisector                  |
| 3. CM-4203  | Westcott Tenotomy Scissors          | 17. CM-4217 | Alfonso Nucleus Forceps, 3x4 teeth       |
| 4. CM-4204  | Castroviejo Forceps, 0.12mm         | 18. CM-4218 | Alfonso-McIntyre Irrigating Spoon, small |
| 5. CM-4205  | Chuck Handle (3)                    | 19. CM-4219 | Alfonso-McIntyre Irrigating Spoon, large |
| 6. CM-4206  | Performance Lamellar Blade #66 (bx) | 20. CM-4220 | McIntyre Infusion Handle                 |
| 7. CM-4207  | Performance Super Sharp Blade (bx)  | 21. CM-4221 | Air Injection Cannula, 27ga.             |
| 8. CM-4208  | Performance Phaco Blade (bx)        | 22. CM-4222 | Anis Cortex Aspirating Cannula, straight |
| 9. CM-4209  | Castroviejo Caliper, straight       | 23. CM-4223 | Brierley Chamber Maintainer              |
| 10. CM-4210 | Utrata Capsulorrhexis Forceps       | 24. CM-4224 | Bipolar Forceps, straight, pointed       |
| 11. CM-4211 | Kuglen Lens Manipulator, angled     | 25. CM-4225 | Dodick IOL Folding Forceps               |
| 12. CM-4212 | Alfonso Cutting Platform, 2mm       | 26. CM-4226 | Buratto Soft IOL Inserter                |
| 13. CM-4213 | Alfonso Cutting Platform, 3mm       | 27. CM-4227 | Silicone Tubing w/adaptor for K7-6750    |
| 14. CM-4214 | Alfonso Nucleus Trisector, oval     | 28. CM-4228 | Sterilizing Case, double, plastic        |

\*not shown

TechniqueVideoAvailable

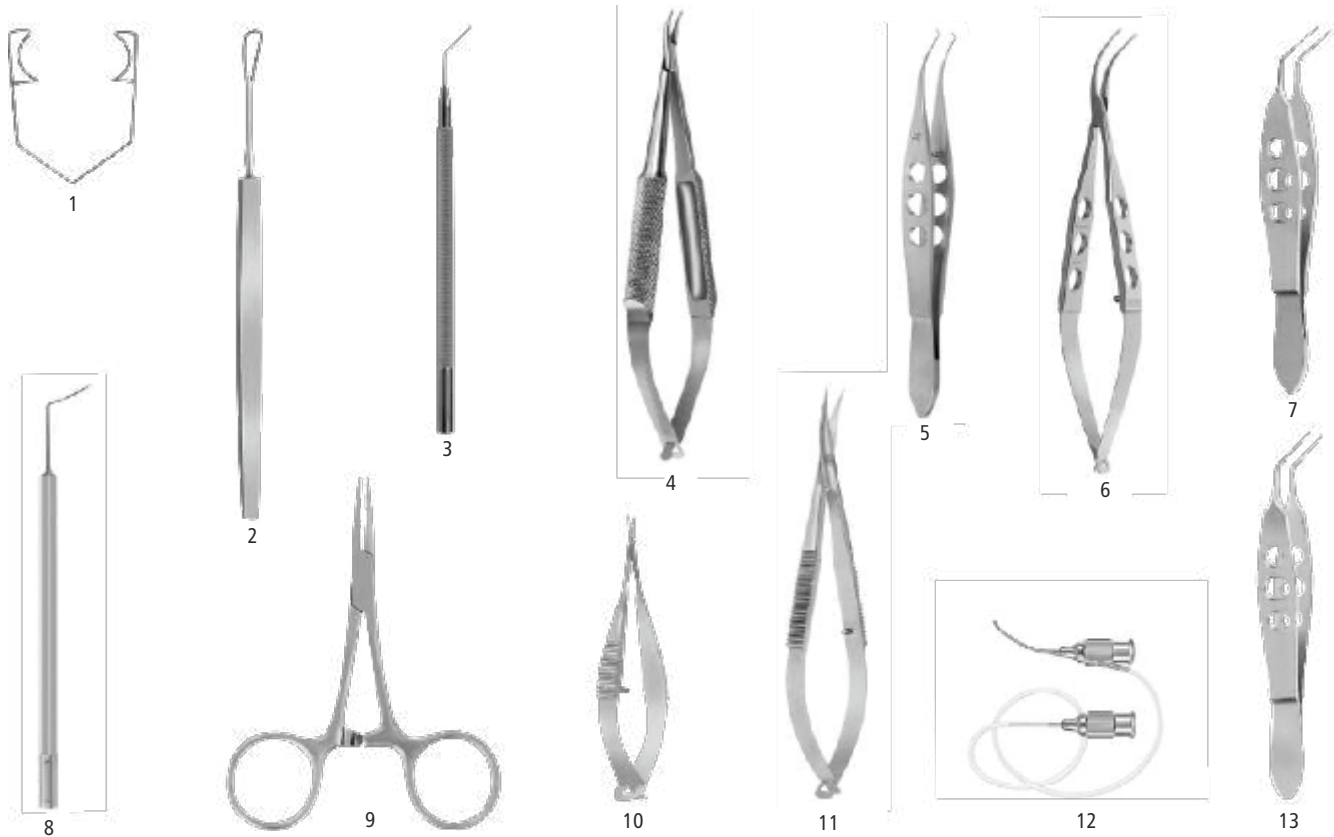

**CM-4300 • MANUAL SMALL INCISION CATARACT SURGERY(MSICS) SET**  
as used by Glenn Strauss, M.D.

- |            |   |             |                                     |
|------------|---|-------------|-------------------------------------|
| 1. CM-4301 | Barraquer Wire Speculum, large            | 8. CM-4308  | Barraquer Iris Spatula, 0.5mm       |
| 2. CM-4302 | Wilder Lens Loop, serrated                | 9. CM-4309  | Hartmann Mosquito Forceps, straight |
| 3. CM-4303 | Sinsky II Lens Hook, angled               | 10. CM-4310 | Vannas Scissors, straight           |
| 4. CM-4304 | Barraquer Needle Holder, curved, titanium | 11. CM-4311 | Westcott Stitch Scissors            |
| 5. CM-4305 | Harms-Colibri Forceps, 0.12mm curved      | 12. CM-4312 | Strauss-Simcoe I/A Cannula          |
| 6. CM-4306 | Shepard Lens Forceps                      | 13. CM-4313 | Utrata Capsulorrhexis Forceps       |
| 7. CM-4307 | Gaskin Fragment Forceps, angled           | 14. CM-4314 | Sterilizing Case, medium, aluminum  |
- \*not shown

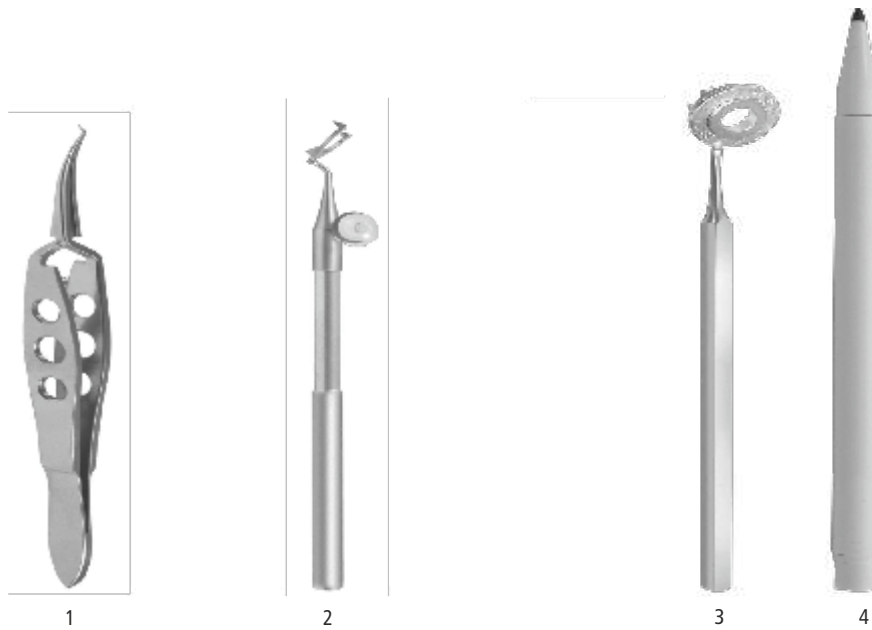

**CM-4400 • LIMBAL RELAXING INCISION SET**

1. CM-4401 LRI Step Knife, 3 Steps (0.5, 0.55, 0.6mm)
2. CM-4402 Hu Femto Forceps
3. CM-4403 Henderson Alignment Marker
4. CM-4404 Alignment Marker with Bubble
5. CM-4405 Henderson Degree Gauge
6. CM-4406 Henderson Limbal Relaxing Incision Marker
7. CM-4407 Chu Limbal Relaxing Incision Marker
8. CM-4408 Marking Pen, sterile, disposable (pk/10)
9. CM-4409 Instrument Case, small, aluminum  
\*not shown

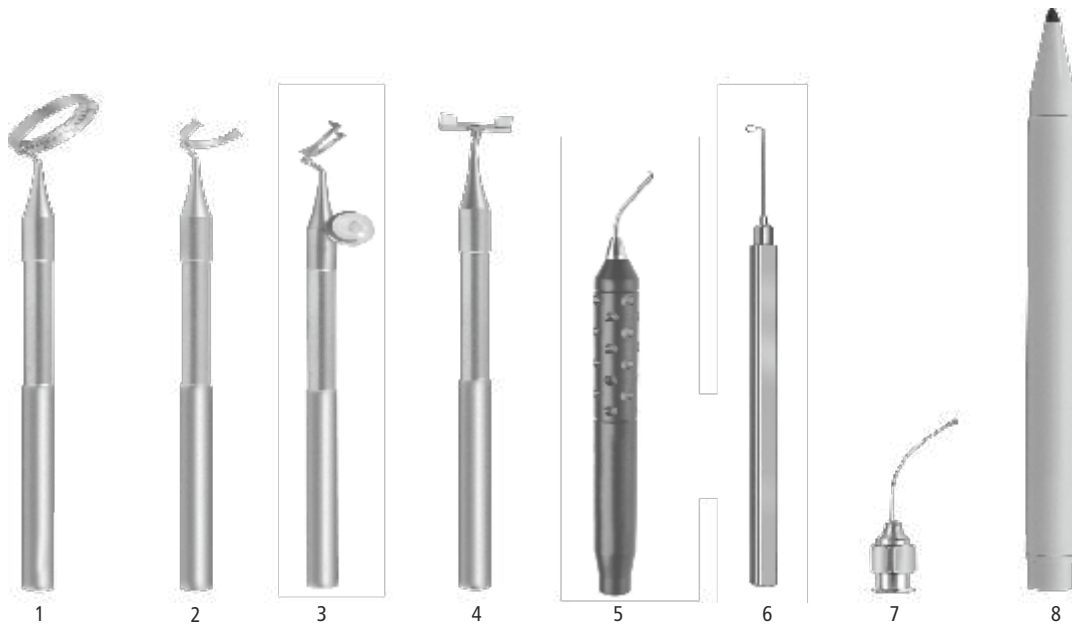

**CM-4500 • TORIC IOL SET**

1. CM-4501 Henderson Degree Gauge
2. CM-4502 Henderson Alignment Marker
3. CM-4503 Alignment Marker with Bubble
4. CM-4504 Henderson Toric IOL Marker
5. CM-4505 Lu Irrigating Toric Lens Manipulator
6. CM-4506 Scorsetti-Shepherd Capsule Polisher, 90°
7. CM-4507 Henderson MICS Capsule Polisher
8. CM-4508 Marking Pen, sterile, disposable (pk/10)
9. CM-4509 Sterilizing Case, medium, plastic  
\*not shown

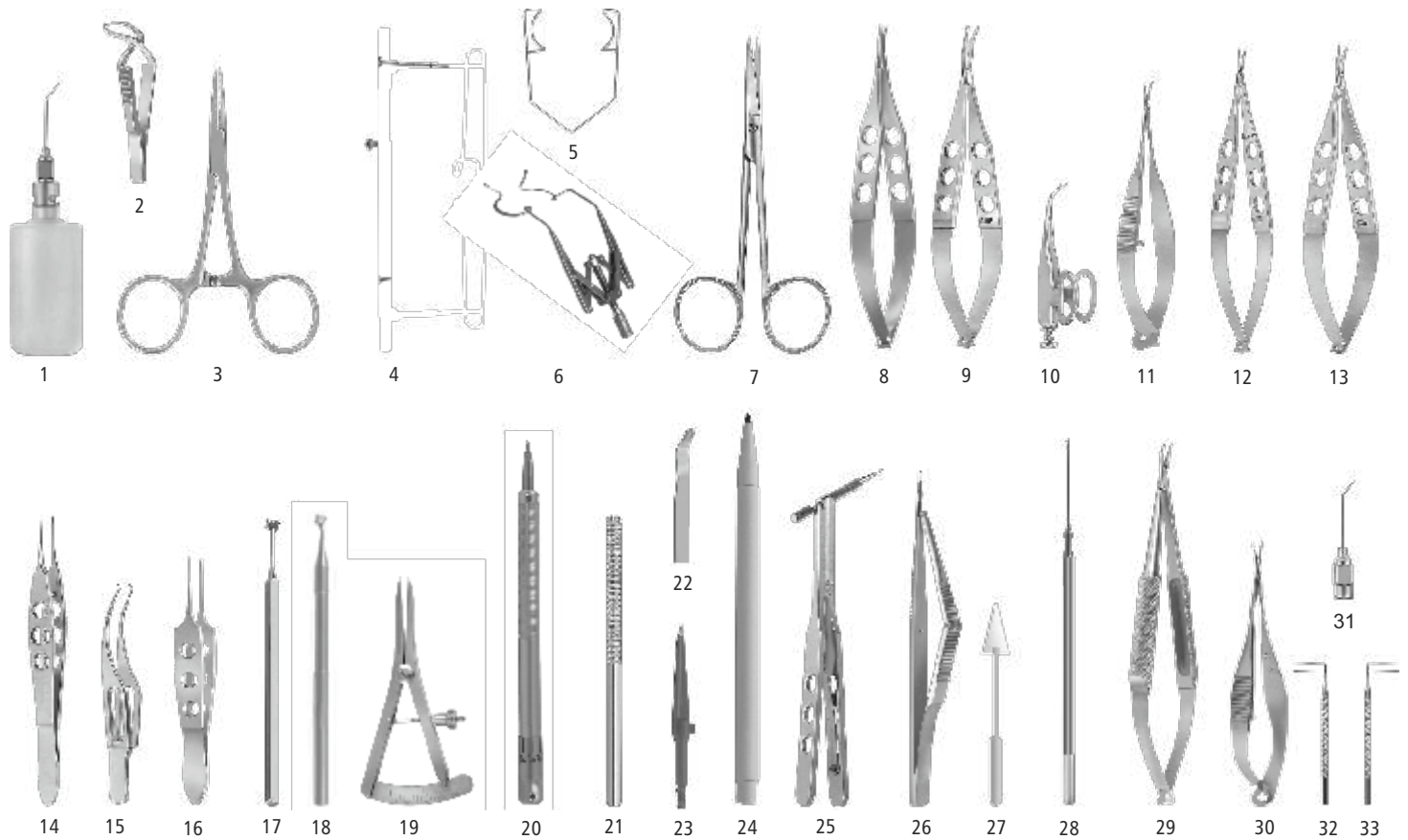

**CM-4600 • GLAUCOMA SET**

- |             |   |             |  |
|-------------|---|-------------|--|
| 1. CM-4601  | Bishop-Harmon A/C Irrigator               | 18. CM-4618 | Fechtner EX-PRESS®Marker                     |
| 2. CM-4602  | Jones Towel Clamp                         | 19. CM-4619 | Castroviejo Caliper, straight                |
| 3. CM-4603  | Hartmann Mosquito Forceps, straight       | 20. CM-4620 | Diamond Step Knife, 10-facet                 |
| 4. CM-4604  | Schott Eye Speculum, adjustable           | 21. CM-4621 | Chuck Handle (2)                             |
| 5. CM-4605  | Barraquer Wire Speculum, large            | 22. CM-4622 | Lamellar Blade #66 (bx)                      |
| 6. CM-4606  | Double-X Speculum, 13mm blades            | 23. CM-4623 | Super Sharp Blade, 15 deg. (bx)              |
| 7. CM-4607  | Eye Scissors, straight                    | 24. CM-4624 | Marking Pen, sterile, disposable (pk/10)     |
| 8. CM-4608  | Sarkisian-Westcott Scissors, small blades | 25. CM-4625 | Luntz-Dodick Trabeculectomy Punch            |
| 9. CM-4609  | Westcott Tenotomy Scissors                | 26. CM-4626 | Kelly Descemet's Membrane Punch              |
| 10. CM-4610 | Barraquer Iris Scissors                   | 27. CM-4627 | K-Sponge Spears                              |
| 11. CM-4611 | Mini Westcott Scissors                    | 28. CM-4628 | Blumenthal Conjunctiva Dissector             |
| 12. CM-4612 | Katena-Vannas Scissors, 7mm, curved       | 29. CM-4629 | Barraquer Needle Holder, curved              |
| 13. CM-4613 | McPherson-Westcott Stitch Scissors        | 30. CM-4630 | Katena Micro Tying Scissors                  |
| 14. CM-4614 | Fechtner Conjunctiva Forceps (2)          | 31. CM-4631 | Air Injection Cannula, 27ga.                 |
| 15. CM-4615 | Colibri Forceps, 0.12mm teeth             | 32. CM-4632 | Harms Trabeculotomy Probe, right             |
| 16. CM-4616 | Bishop-Harmon Forceps                     | 33. CM-4633 | Harms Trabeculotomy Probe, left              |
| 17. CM-4617 | Fechtner Trabeculectomy Marker            | 34. CM-4634 | Sterilizing Case, double, aluminum not shown |

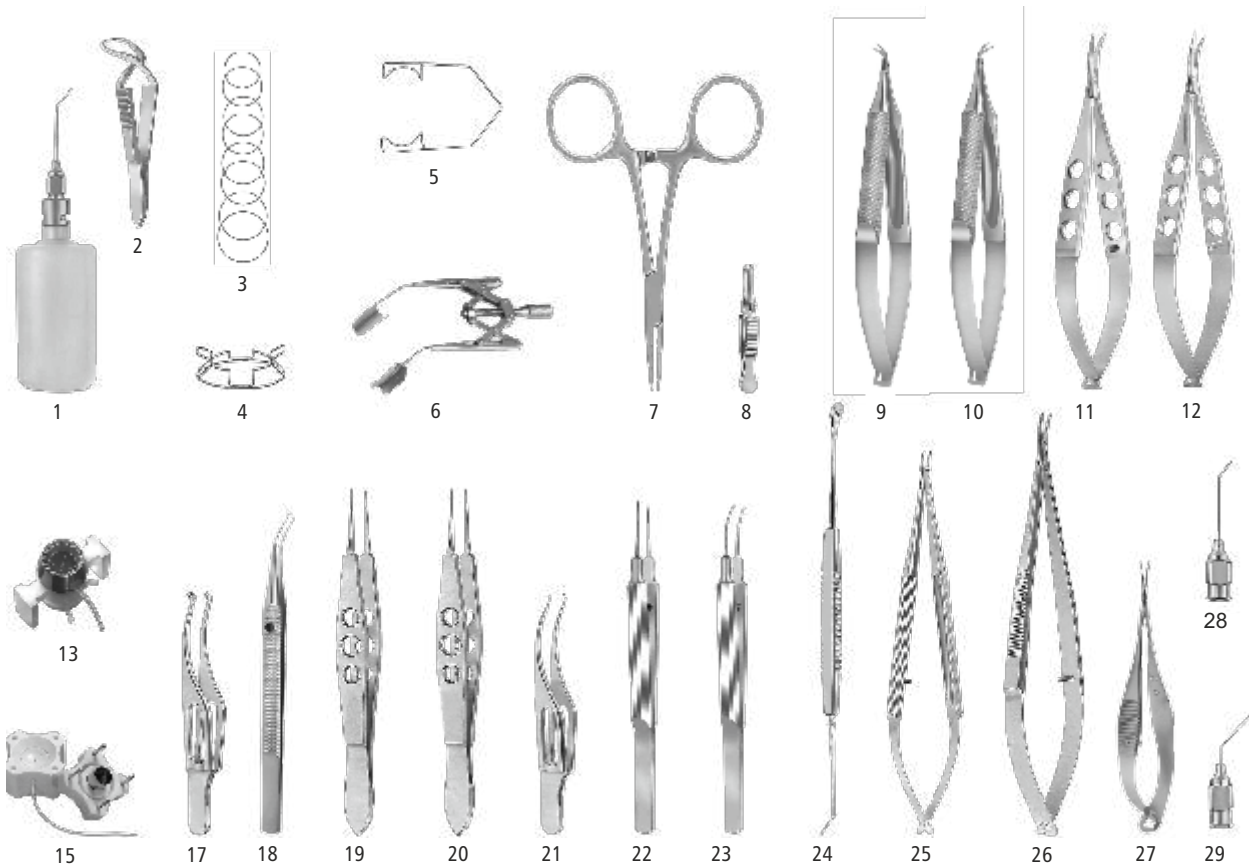

**CM-4700 • CORNEAL TRANSPLANT SET**

- |             |   |             |   |
|-------------|---|-------------|---|
| 1. CM-4701  | Bishop-Harmon A/C Irrigator             | 17. CM-4717 | Polack Double Corneal Fixation Forceps          |
| 2. CM-4702  | Jones Towel Clamp                       | 18. CM-4718 | Perl Corneal Forceps, 0.08mm, left              |
| 3. CM-4703  | Flieringa Rings (set of 8)              | 19. CM-4719 | Castroviejo Forceps, 0.12mm                     |
| 4. CM-4704  | McNeill-Goldman Fixation Ring           | 20. CM-4720 | Castroviejo Forceps, 0.3mm                      |
| 5. CM-4705  | Barraquer Wire Speculum, large          | 21. CM-4721 | Harms-Colibri Forceps, 0.12mm                   |
| 6. CM-4706  | Double-X Speculum, solid blade 15mm     | 22. CM-4722 | Tennant Tying Forceps, straight                 |
| 7. CM-4707  | Hartmann Mosquito Forceps, straight (2) | 23. CM-4723 | Tennant Tying Forceps, curved                   |
| 8. CM-4708  | Serrefine, small, straight (2)          | 24. CM-4724 | Paton Spatula & Spoon                           |
| 9. CM-4709  | Terry Micro Corneal Scissors, left      | 25. CM-4725 | Katena Needle Holder, curved w/lock             |
| 10. CM-4710 | Terry Micro Corneal Scissors, right     | 26. CM-4726 | Castroviejo Needle Holder, curved w/lock        |
| 11. CM-4711 | Westcott Tenotomy Scissors              | 27. CM-4727 | Katena Micro Tying Scissors                     |
| 12. CM-4712 | Jaffe Stitch Scissors                   | 28. CM-4728 | Air Injection Cannula, 30ga.                    |
| 13. CM-4713 | Barron Vacuum Trephine, 7.5mm           | 29. CM-4729 | McIntyre A/C Cannula, 26ga.                     |
| 14. CM-4714 | Barron Vacuum Trephine, 8.0mm           | 30. CM-4730 | Sterilizing Case, double, aluminum              |
| 15. CM-4715 | Barron Vacuum Punch, 8.0mm              | 31. CM-4731 | K-Sponge II spears, synthetic (bx)<br>not shown |
| 16. CM-4716 | Barron Vacuum Punch, 8.5mm              |             |   |

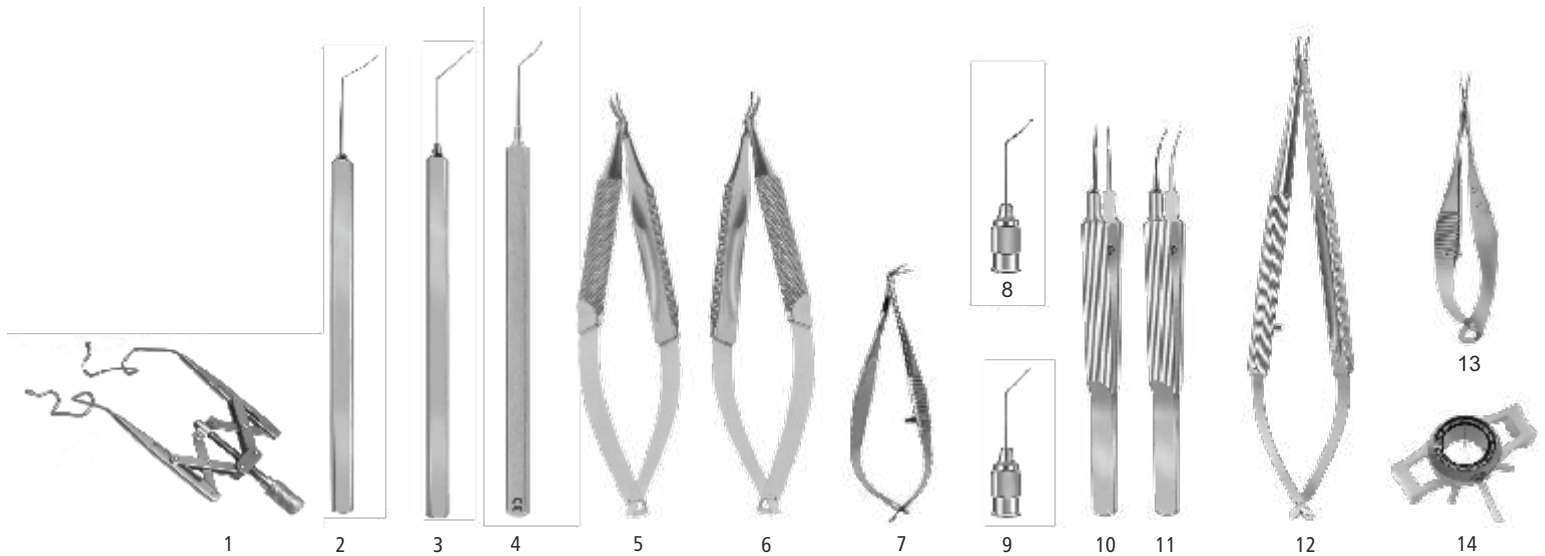

**CM-4800 • DEEP ANTERIOR LAMELLAR KERATOPLASTY (DALK) SET**

1. CM-4801 Double-X Speculum, K-Wire, 15mm blades
2. CM-4802 DALK Corneal Dissector
3. CM-4803 Rosenwasser DALK Trisector
4. CM-4804 Bonfadini DALK Spatula
5. CM-4805 Holland DALK Scissors, left
6. CM-4806 Holland DALK Scissors, right
7. CM-4807 Holland DALK Scissors, angled, blunt
8. CM-4808 DALK Air Injection Cannula, 27ga.
9. CM-4809 Rosenwasser DALK Cannula, 27ga.
10. CM-4810 Tennant Tying Forceps, delicate, straight
11. CM-4811 Tennant Tying Forceps, delicate, curved
12. CM-4812 Katena Needle Holder, extra-delicate, curved
13. CM-4813 Katena Micro Tying Scissors
14. CM-4814 Barron Radial Vacuum Trephine, 8.0mm
15. CM-4815 Sterilizing Case, medium, aluminum not shown

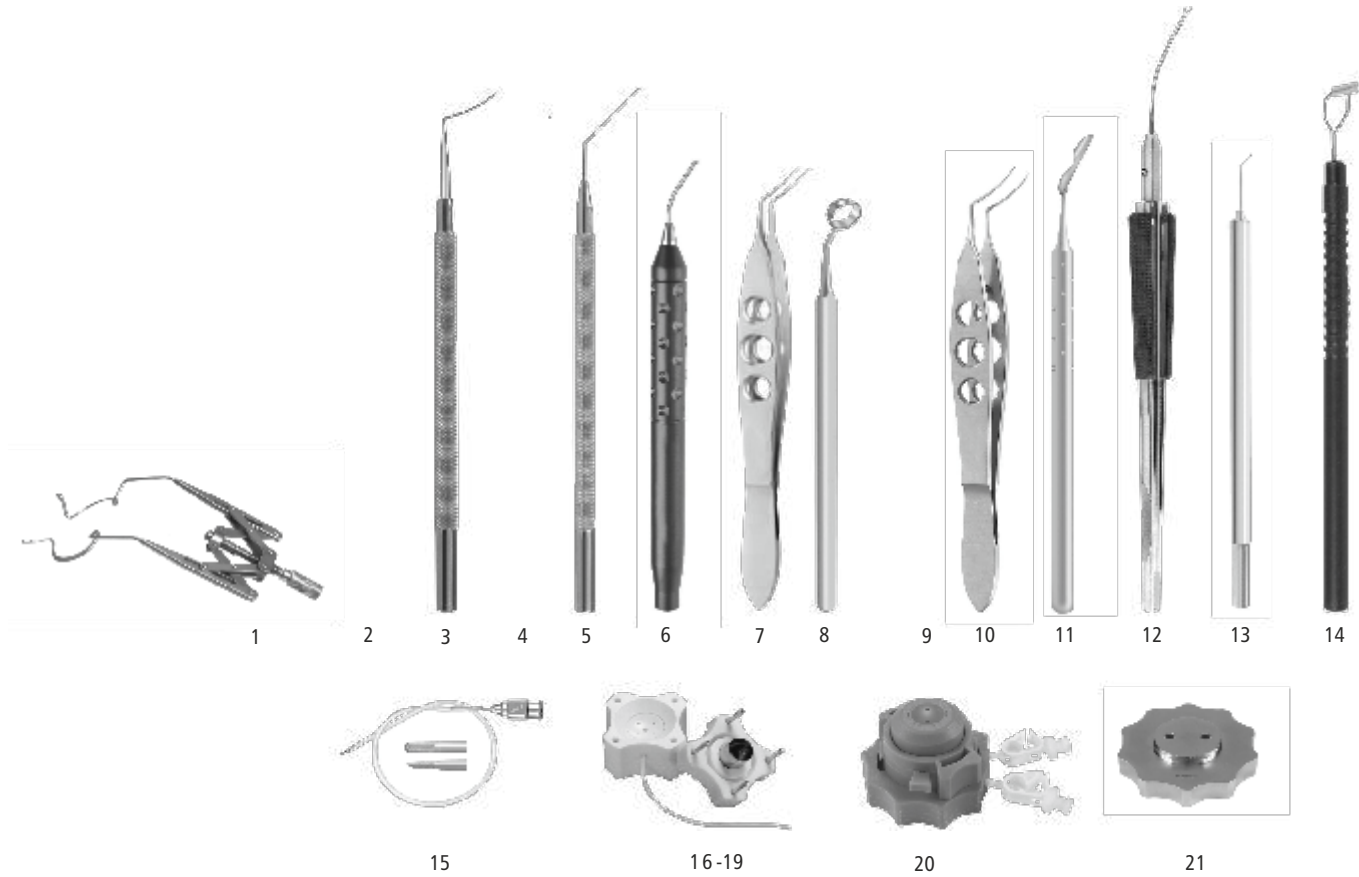

**CM-4900 • ENDOTHELIAL TRANSPLANTATION SET**

- |   |  |
|---|--|
| 1. CM-4901 Double-X Speculum, 13mm blades               | 12. CM-4912 DSEK Grasping Forceps, 23ga.               |
| 2. CM-4902 Corneal Dissector, straight                  | 13. CM-4913 Rootman-Goldich DMEK Dissector             |
| 3. CM-4903 Corneal Dissector, vaulted                   | 14. CM-4914 Rubenstein Corneal Roller, sterile (pk/3)  |
| 4. CM-4904 Reversed Sinskey Hook                        | 15. CM-4915 Dahan-Blumenthal A/C Maintainer            |
| 5. CM-4905 Endothelial Stripper                         | 16. CM-4916 Barron Vacuum Punch, 8.5mm                 |
| 6. CM-4906 Rosenwasser Irrigating Endothelial Stripper  | 17. CM-4917 Barron Vacuum Punch, 8.75mm                |
| 7. CM-4907 Florakis Endothelial Forceps                 | 18. CM-4918 Barron Vacuum Punch, 9.0mm                 |
| 8. CM-4908 Bore Optic Zone Marker, 9.0mm                | 19. CM-4919 Barron Vacuum Punch, 9.5mm                 |
| 9. CM-4909 Rosenwasser Donor Lamellar Inserting Shovel  | 20. CM-4920 Barron Artificial Anterior Chamber         |
| 10. CM-4910 Rosenwasser Donor Lamella Inserting Forceps | 21. CM-4921 Barron Stainless Steel Base                |
| 11. CM-4911 Endothelial Glide Spatula                   | 22. CM-4922 Instrument Case, large, aluminum not shown |

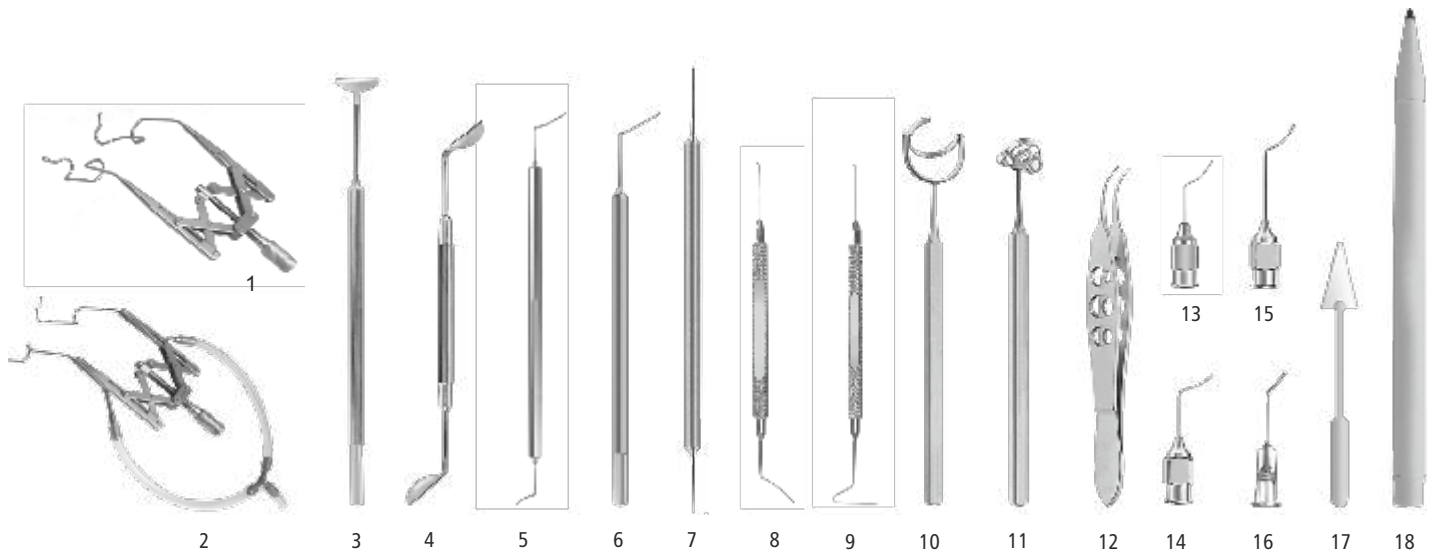

**CM-5000 • LASIK SET**

- |             |   |             |  |
|-------------|---|-------------|--|
| 1. CM-5001  | Double-X Speculum, K-Wire, 15mm blades  | 11. CM-5011 | Chayet Corneal Marker                    |
| 2. CM-5002  | Double-X Aspirating Speculum (optional) | 12. CM-5012 | Buratto LASIK Flap Forceps               |
| 3. CM-5003  | Buratto Flap Protector                  | 13. CM-5013 | Banaji LASIK Cannula, 26ga.              |
| 4. CM-5004  | Mannis-Buratto Flap Protector           | 14. CM-5014 | Spatulated LASIK Cannula, 26ga.          |
| 5. CM-5005  | Hersh LASIK Spatula                     | 15. CM-5015 | Buratto LASIK Cannula, 3-ports, 23ga.    |
| 6. CM-5006  | Fukasaku LASIK Spatula                  | 16. CM-5016 | John IntraLasik Cannula, sterile (pk/10) |
| 7. CM-5007  | Katzen LASIK Flap Unzipper              | 17. CM-5017 | K-Sponge II spears, synthetic (bx)       |
| 8. CM-5008  | Thorlakson Z-LASIK™ Flap Lifter         | 18. CM-5018 | Marking Pen, standard (pk/10)            |
| 9. CM-5009  | IntraLase® Flap Lifter, D-E             | 19. CM-5019 | Instrument Case, large, aluminum         |
| 10. CM-5010 | Gimbel Stabilization Ring               |             | not shown                                |

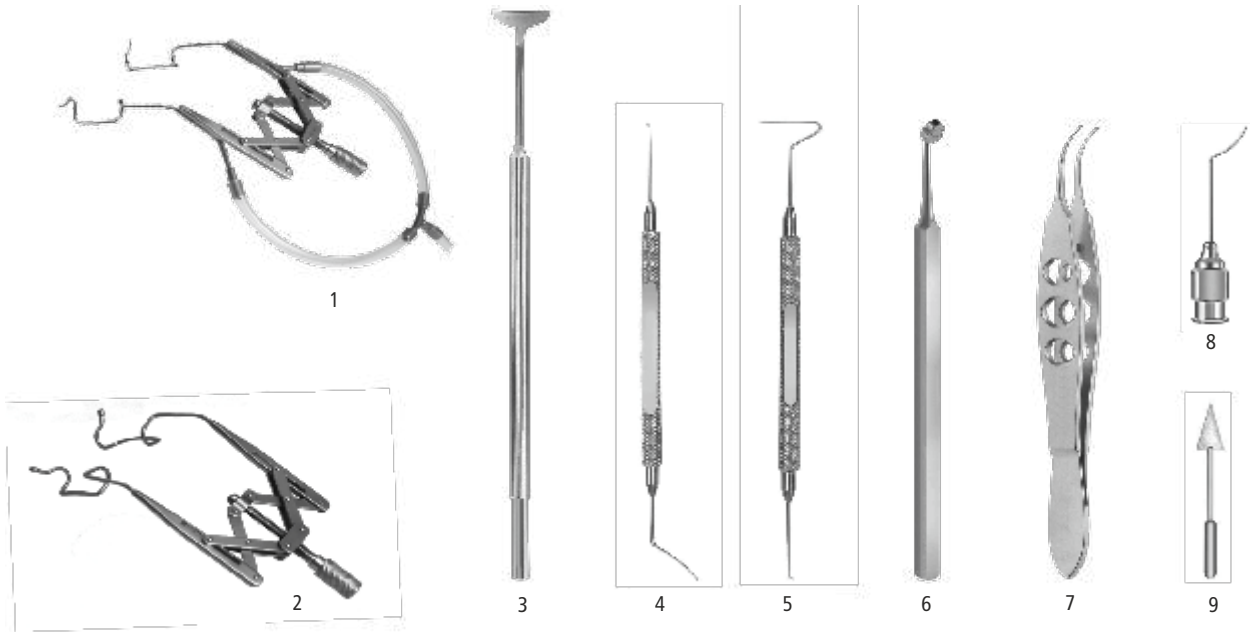

**CM-5100 • FEMTOSECOND LASIK SET**

1. CM-5101 Double-X Aspirating Speculum
2. CM-5102 Double-X Speculum, K-Wire, 15mm blades
3. CM-5103 Buratto LASIK Flap Protector
4. CM-5104 Thorlakson Z-LASIK™ Flap Lifter, short handle
5. CM-5105 IntraLase® Flap Lifter, D-E
6. CM-5106 Dulaney Corneal Marker
7. CM-5107 Buratto LASIK Flap Forceps
8. CM-5108 Buratto LASIK Cannula, 23ga.
9. CM-5109 K-Sponge II Spears, synthetic (bx)
10. CM-5110 Instrument Case, small, aluminum  
not shown

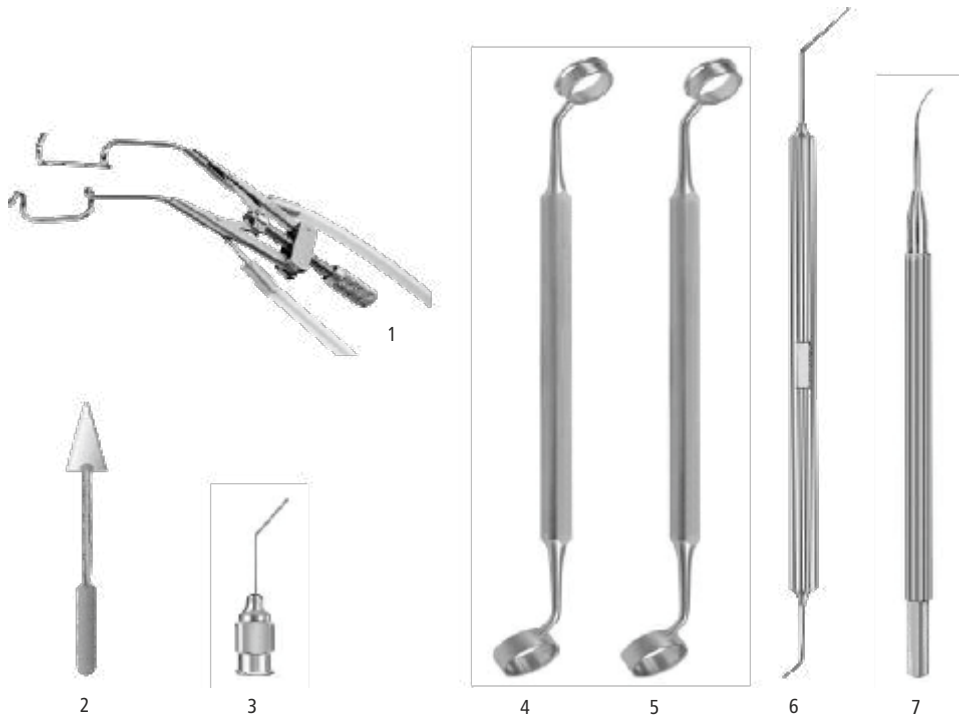

**CM-5200 • LASEK SET**

- |            |                               |            |   |
|------------|-------------------------------|------------|---|
| 1. CM-5201 | Lieberman Aspirating Speculum | 5. CM-5205 | Trephine & Well 9/9.5mm                       |
| 2. CM-5202 | K-Sponge II, synthetic (bx)   | 6. CM-5206 | Micro-Hoe & Epi-Peeler                        |
| 3. CM-5203 | Alcohol Cannula               | 7. CM-5207 | Flap Repositor                                |
| 4. CM-5204 | Trephine & Well 8/8.5mm       | 8. CM-5208 | Instrument Case, small, aluminum<br>not shown |

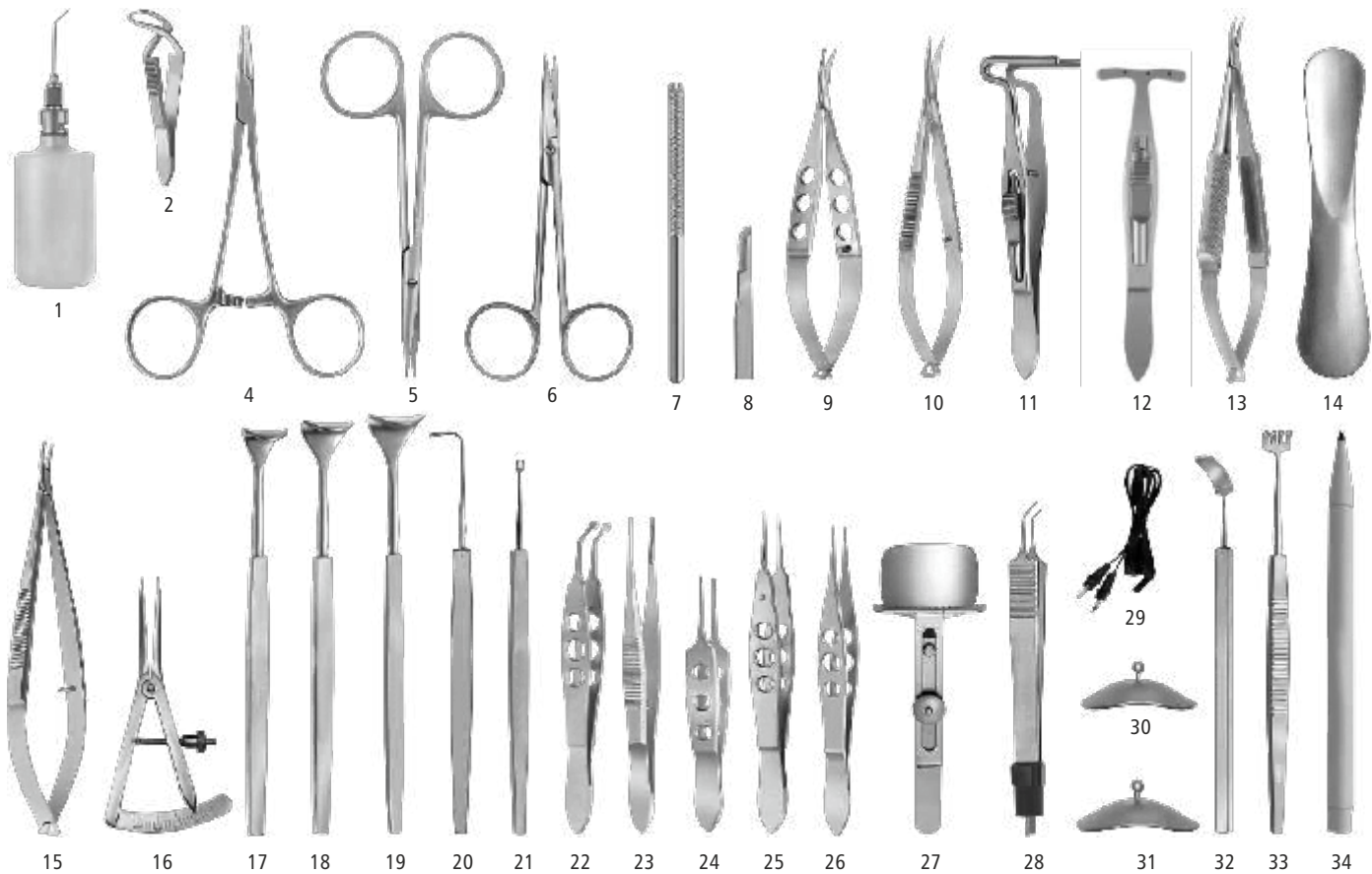

**CM-5300 • LID SET**

- |     |         |                                      |     |         |  |
|-----|---------|--------------------------------------|-----|---------|--|
| 1.  | CM-5301 | Bishop-Harmon A/C Irrigator          | 19. | CM-5319 | Desmarres Lid Retractor #3                   |
| 2.  | CM-5302 | Jones Towel Clamp, 2 1/4"            | 20. | CM-5320 | Graefe Muscle Hook #2                        |
| 3.  | CM-5303 | Halsted Mosquito Forceps, curved (2) | 21. | CM-5321 | Fixation Hook, double                        |
| 4.  | CM-5304 | Halsted Mosquito Forceps, straight   | 22. | CM-5322 | Arita Meibomian Gland Compressor             |
| 5.  | CM-5305 | Stevens Scissors, straight           | 23. | CM-5323 | Bonaccolto Conjunctiva Forceps               |
| 6.  | CM-5306 | Eye Scissors, straight               | 24. | CM-5324 | Bishop-Harmon Forceps                        |
| 7.  | CM-5307 | Chuck Handle                         | 25. | CM-5325 | Castroviejo Forceps, 0.3mm                   |
| 8.  | CM-5308 | Performance Miniature Blade #67 (bx) | 26. | CM-5326 | Helveston Tying Forceps                      |
| 9.  | CM-5309 | Westcott Tenotomy Scissors           | 27. | CM-5327 | Downes Lid Clamp                             |
| 10. | CM-5310 | Westcott Stitch Scissors             | 28. | CM-5328 | Bipolar Forceps, angled, blunt               |
| 11. | CM-5311 | Berke Ptosis Forceps                 | 29. | CM-5329 | Bipolar Cord                                 |
| 12. | CM-5312 | Ptosis Lid Clamp, 6-pin, concave     | 30. | CM-5330 | Scleral Shield, small, pair                  |
| 13. | CM-5313 | Barraquer Needle Holder, curved      | 31. | CM-5331 | Scleral Shield, large, pair                  |
| 14. | CM-5314 | Jaeger Lid Plate, stainless steel    | 32. | CM-5332 | Helveston Retractor, concave, 11mm           |
| 15. | CM-5315 | Castroviejo Needle Holder, curved    | 33. | CM-5333 | Knapp Retractor, 4-prong                     |
| 16. | CM-5316 | Castroviejo Caliper, straight        | 34. | CM-5334 | Marking Pen, (pk/10)                         |
| 17. | CM-5317 | Desmarres Lid Retractor #1           | 35. | CM-5335 | Sterilizing Case, double, aluminum not shown |
| 18. | CM-5318 | Desmarres Lid Retractor #2           |     |         |  |

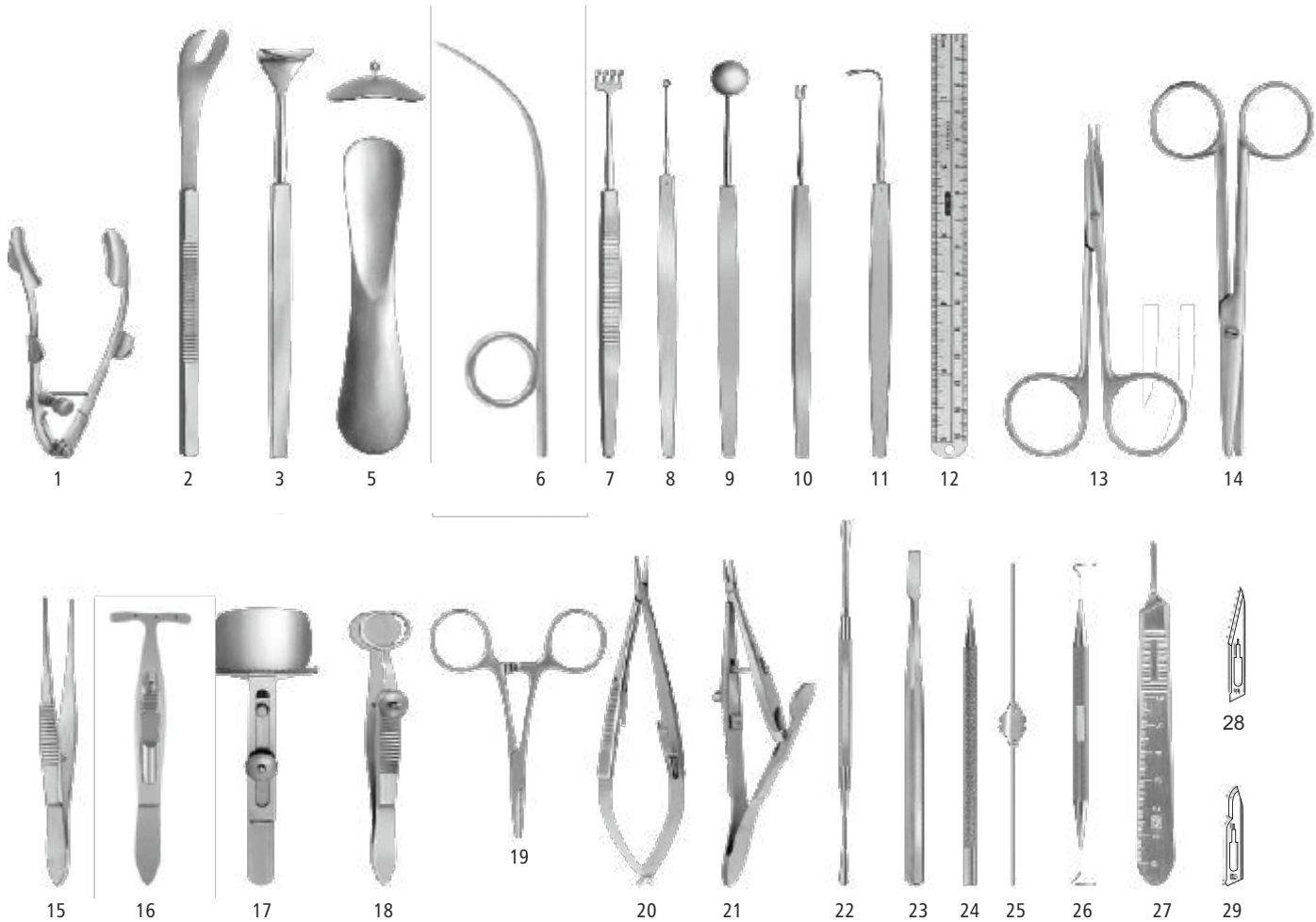

**CM-5400 • OCULOPLASTIC SET**

- |             |                                      |             |   |
|-------------|--------------------------------------|-------------|---|
| 1. CM-5401  | Lester-Burch Eye Speculum            | 16. CM-5416 | Ptosis Lid Clamp, 6-pin, concave                |
| 2. CM-5402  | Schepens Orbital Retractor           | 17. CM-5417 | Downes Lid Clamp                                |
| 3. CM-5403  | Desmarres Lid Retractor #2           | 18. CM-5418 | Francis Chalazion Forceps                       |
| 4. CM-5404  | Scleral Shield, large (pair)         | 19. CM-5419 | Hartmann Mosquito Forceps, straight (2)         |
| 5. CM-5405  | Jaeger Lid Plate, stainless steel    | 20. CM-5420 | Castroviejo Needle Holder, straight with lock   |
| 6. CM-5406  | Wright Fascia Needle                 | 21. CM-5421 | Kalt Needle Holder                              |
| 7. CM-5407  | Knapp Retractor, 4-prong, blunt      | 22. CM-5422 | Freer Periosteal Elevator                       |
| 8. CM-5408  | Meyerhoefer Curette #3               | 23. CM-5423 | West Lacrimal Chisel, straight                  |
| 9. CM-5409  | Bunge Evisceration Spoon             | 24. CM-5424 | Wilder Lacrimal Dilator #2                      |
| 10. CM-5410 | Fixation Hook, double, large         | 25. CM-5425 | Bowman Lacrimal Probe #3-4                      |
| 11. CM-5411 | Graefe Muscle Hook                   | 26. CM-5426 | Pigtail Probe                                   |
| 12. CM-5412 | Stainless Steel Ruler                | 27. CM-5427 | Bard-Parker Handle                              |
| 13. CM-5413 | Stevens Scissors, straight           | 28. CM-5428 | Bard-Parker Blade #11                           |
| 14. CM-5414 | Enucleation Scissors, medium, curved | 29. CM-5429 | Bard-Parker Blade #15                           |
| 15. CM-5415 | Tissue Forceps, 1x2, straight        | 30. CM-5430 | Sterilizing Case, double, aluminum<br>not shown |

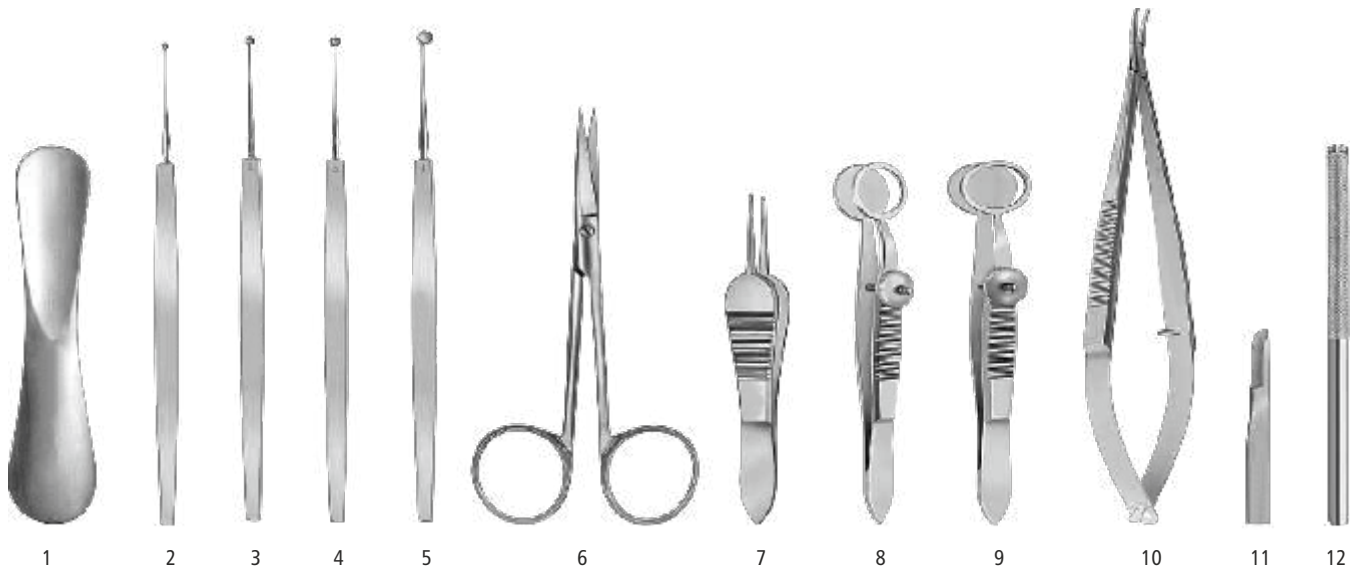

**CM-5500 • CHALAZION SET**

1. CM-5501 Jaeger Lid Plate, stainless steel
2. CM-5502 Meyerhoefer Curette #1
3. CM-5503 Meyerhoefer Curette #2
4. CM-5504 Meyerhoefer Curette #3
5. CM-5505 Meyerhoefer Curette #4
6. CM-5506 Eye Scissors, curved
7. CM-5507 Manhattan Eye & Ear Suture Forceps
8. CM-5508 Hunt Chalazion Forceps
9. CM-5509 Francis Chalazion Forceps
10. CM-5510 Castroviejo Needle Holder, curved
11. CM-5511 Performance Miniature Blade #67 (bx)
12. CM-5512 Chuck Handle
13. CM-5513 Sterilizing Case, large, plastic  
not shown

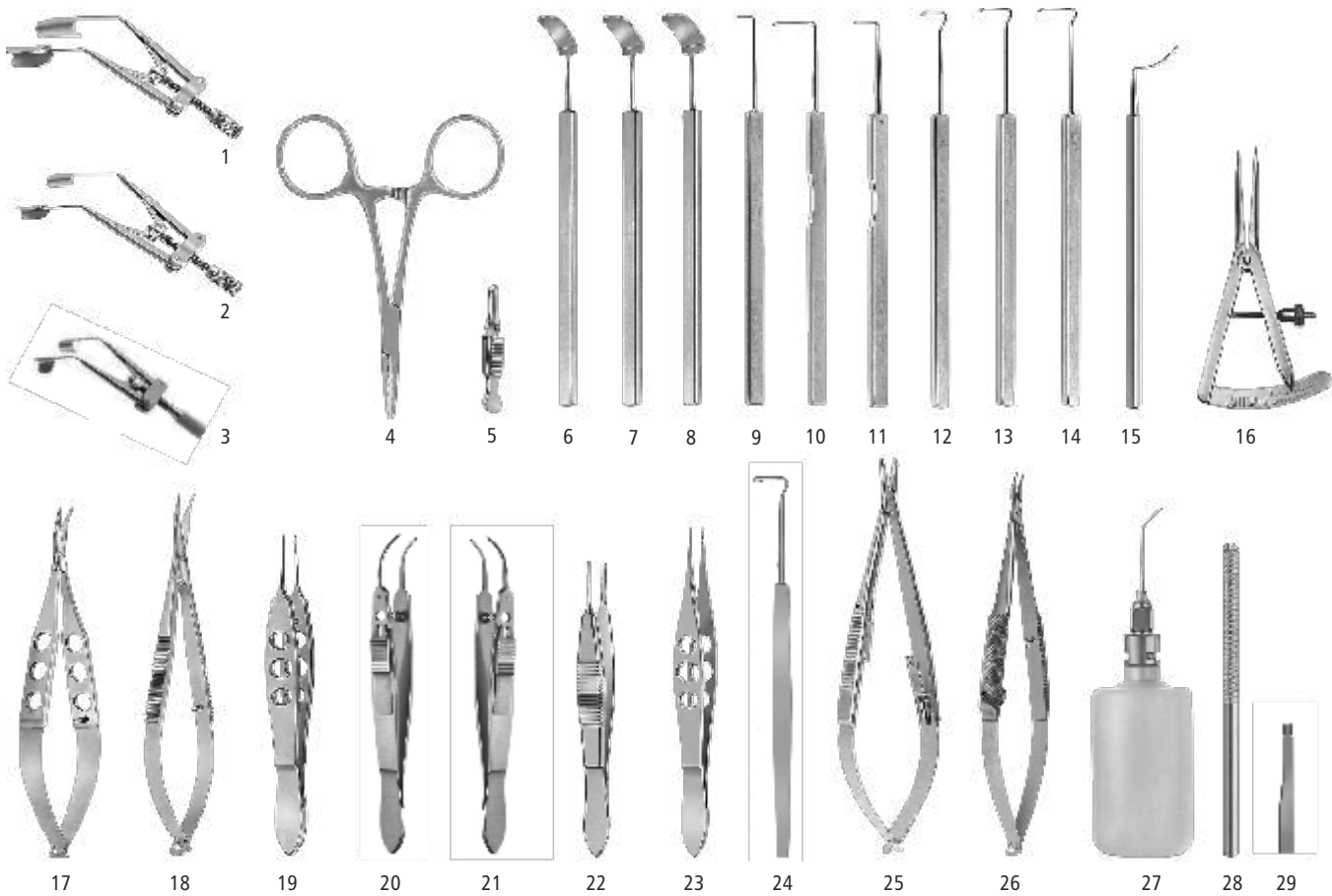

**CM-5600 • STRABISMUS SET**

- |             |  |             |   |
|-------------|--|-------------|---|
| 1. CM-5601  | Lieberman Speculum, solid blade, large | 16. CM-5616 | Castroviejo Caliper, straight                   |
| 2. CM-5602  | Lieberman Speculum, solid blade, small | 17. CM-5617 | Westcott Tenotomy Scissors                      |
| 3. CM-5603  | Lieberman Infant Speculum, solid blade | 18. CM-5618 | Westcott Stitch Scissors                        |
| 4. CM-5604  | Hartmann Mosquito Forceps, curved (2)  | 19. CM-5619 | Bonn Forceps, 0.12mm                            |
| 5. CM-5605  | Serrefine, small, straight (2)         | 20. CM-5620 | Moody Fixation Forceps, left                    |
| 6. CM-5606  | Helveston "Barbie" Retractor           | 21. CM-5621 | Moody Fixation Forceps, right                   |
| 7. CM-5607  | Helveston "Big Barbie" Retractor       | 22. CM-5622 | Lester Fixation Forceps, 2x3 (3)                |
| 8. CM-5608  | Helveston "Great Big Barbie" Retractor | 23. CM-5623 | Helveston Tying Forceps (2)                     |
| 9. CM-5609  | Helveston Teaser Hook, 6mm (3)         | 24. CM-5624 | Rychwalski Muscle Hook, with grooves            |
| 10. CM-5610 | Helveston Finder Hook, large           | 25. CM-5625 | Castroviejo Needle Holder, straight, w/lock     |
| 11. CM-5611 | Helveston Finder Hook, small           | 26. CM-5626 | Barraquer Needle Holder, curved, w/lock         |
| 12. CM-5612 | Helveston Muscle Hook, 8mm             | 27. CM-5627 | Bishop-Harmon A/C Irrigator                     |
| 13. CM-5613 | Helveston Muscle Hook, 10mm            | 28. CM-5628 | Chuck Handle                                    |
| 14. CM-5614 | Helveston Muscle Hook, 12mm            | 29. CM-5629 | Performance Miniature Blade #69 (bx)            |
| 15. CM-5615 | Helveston Scleral Ruler                | 30. CM-5630 | Sterilizing Case, double, aluminum<br>not shown |

Technique Video Available

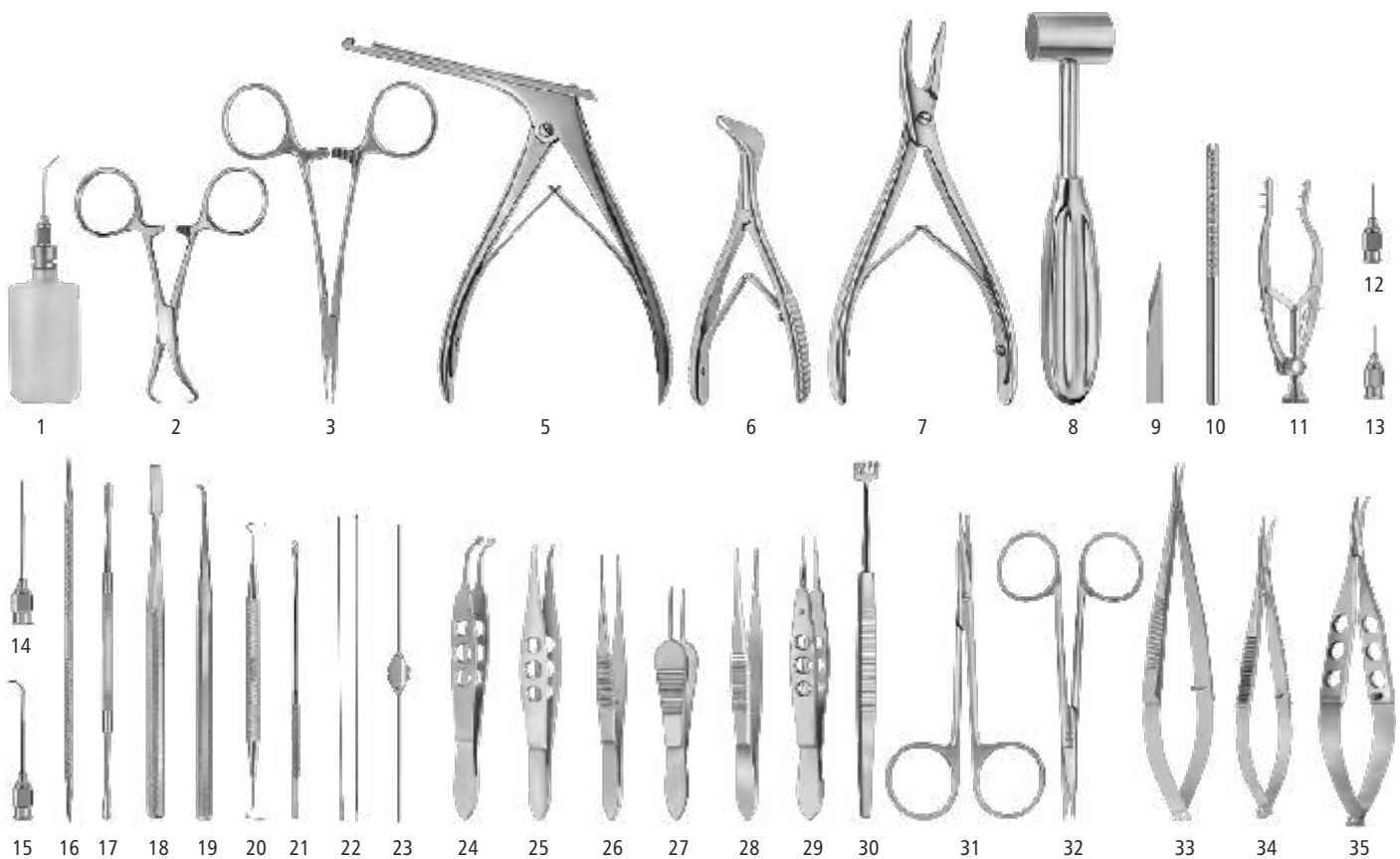

**CM-5700 • LACRIMAL SET**

- |             |  |             |   |
|-------------|--|-------------|---|
| 1. CM-5701  | Bishop-Harmon A/C Irrigator            | 20. CM-5720 | Pigtail Probe                                   |
| 2. CM-5702  | Backhaus Towel Clamp (2)               | 21. CM-5721 | Crawford Retrieving Hook                        |
| 3. CM-5703  | Halsted Mosquito Forceps, straight (2) | 22. CM-5722 | Crawford Lacrimal Intubation Set                |
| 4. CM-5704  | Halsted Mosquito Forceps, curved (2)   | 23. CM-5723 | Bowman Lacrimal Probe Set of 6                  |
| 5. CM-5705  | Kerrison Rongeur, size 1               | 24. CM-5724 | Arita Meibomian Gland Compressor                |
| 6. CM-5706  | Nasal Speculum, adult                  | 25. CM-5725 | Gold Punctal Plug Forceps                       |
| 7. CM-5707  | Beyer Rongeur                          | 26. CM-5726 | Dressing Forceps, delicate, straight            |
| 8. CM-5708  | Mallet, lead filled stainless steel    | 27. CM-5727 | Sauer Fixation Forceps, 1x2                     |
| 9. CM-5709  | Performance Miniature Blade #65 (bx)   | 28. CM-5728 | Bonaccolto Conjunctiva Forceps                  |
| 10. CM-5710 | Chuck Handle                           | 29. CM-5729 | Castroviejo Forceps, 0.3mm                      |
| 11. CM-5711 | Stevenson Retractor                    | 30. CM-5730 | Knapp Retractor, 4-prong, blunt (2)             |
| 12. CM-5712 | Shahinian Lacrimal Cannula             | 31. CM-5731 | Stevens Scissors, curved                        |
| 13. CM-5713 | Burnstine Lacrimal Cannula             | 32. CM-5732 | Eye Scissors, straight                          |
| 14. CM-5714 | Lacrimal Cannula, straight             | 33. CM-5733 | Castroviejo Needle Holder, curved w/lock        |
| 15. CM-5715 | Lacrimal Cannula, curved               | 34. CM-5734 | Westcott Stitch Scissors                        |
| 16. CM-5716 | Castroviejo Lacrimal Dilator           | 35. CM-5735 | Tibolt Punctal Scissors                         |
| 17. CM-5717 | Freer Periosteal Elevator              | 36. CM-5736 | K-Sponge Spears, sterile (bx)                   |
| 18. CM-5718 | West Lacrimal Chisel, straight         | 37. CM-5737 | Sterilizing Case, double, aluminum<br>not shown |
| 19. CM-5719 | Freer Lacrimal Chisel, curved          |             |   |

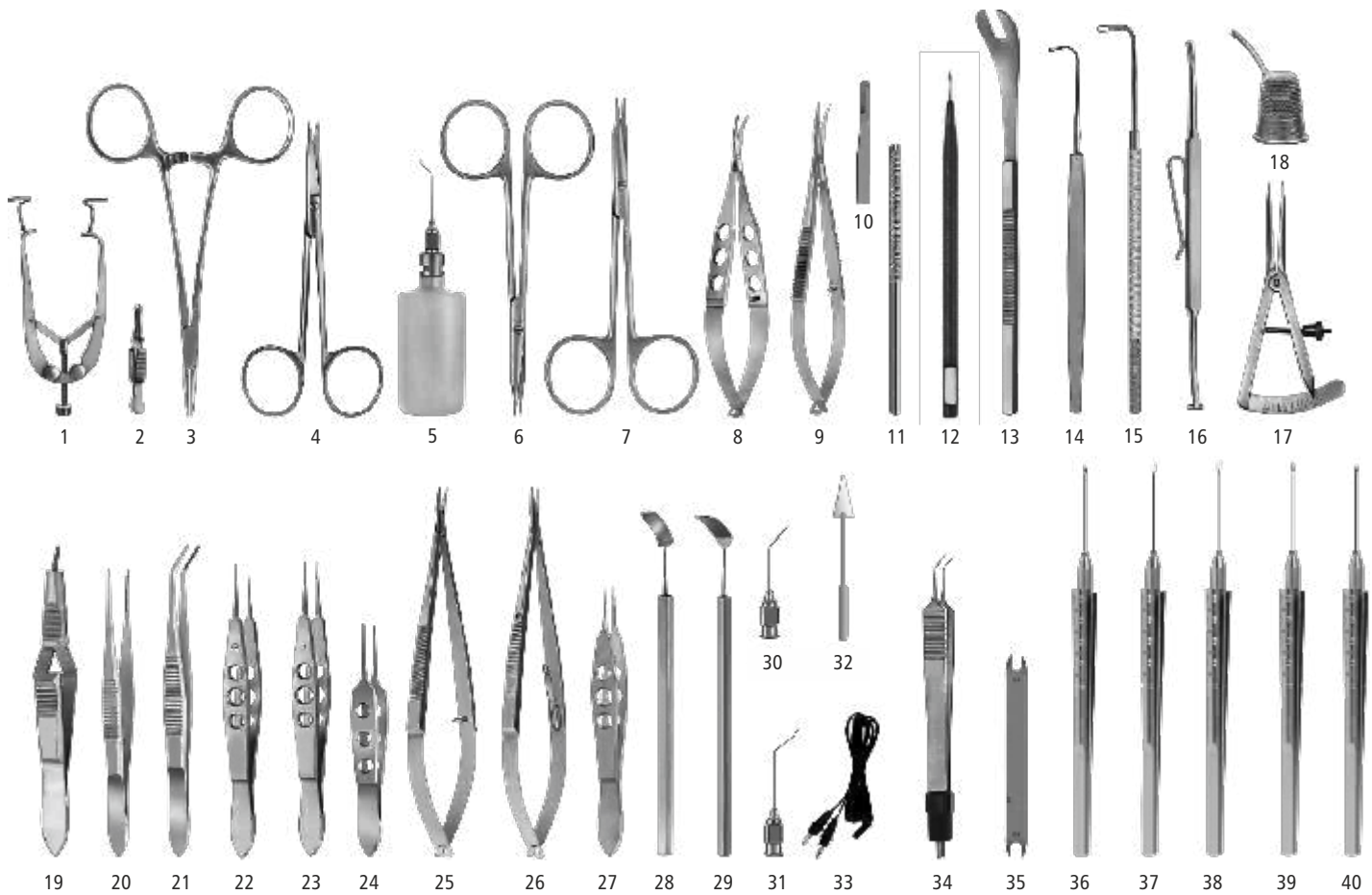

**CM-5800 • VITREORETINAL SET, 23 GAUGE**

- |             |  |             |  |
|-------------|--|-------------|--|
| 1. CM-5801  | Fishkind-Castroviejo Speculum          | 22. CM-5822 | Castroviejo Forceps, 0.12mm                        |
| 2. CM-5802  | Serrefine, small, straight (4)         | 23. CM-5823 | Castroviejo Forceps, 0.3mm                         |
| 3. CM-5803  | Halsted Mosquito Forceps, straight (2) | 24. CM-5824 | Bishop-Harmon Forceps (2)                          |
| 4. CM-5804  | Eye Scissors, straight                 | 25. CM-5825 | Castroviejo Needle Holder, curved, w/lock          |
| 5. CM-5805  | Bishop-Harmon A/C Irrigator            | 26. CM-5826 | Castroviejo Needle Holder, straight                |
| 6. CM-5806  | Stevens Scissors, straight             | 27. CM-5827 | McPherson Tying Forceps, straight                  |
| 7. CM-5807  | Stevens Scissors, curved               | 28. CM-5828 | Helveston Barbie Retractor                         |
| 8. CM-5808  | Westcott Tenotomy Scissors             | 29. CM-5829 | Helveston Retractor, concave, 11mm                 |
| 9. CM-5809  | Westcott Stitch Scissors               | 30. CM-5830 | Viscoelastic Aspiration Cannula, 22ga.             |
| 10. CM-5810 | Miniature Blade #64 (bx)               | 31. CM-5831 | Randolph Cyclodialysis Cannula, 19ga.              |
| 11. CM-5811 | Chuck Handle                           | 32. CM-5832 | K-Sponge Spears (bx)                               |
| 12. CM-5812 | MVR Knife, 1.5mm, 19 gauge             | 33. CM-5833 | Bipolar Cord                                       |
| 13. CM-5813 | Schepens Orbital Retractor             | 34. CM-5834 | Bipolar Forceps, angled, blunt                     |
| 14. CM-5814 | Graefe Muscle Hook #2                  | 35. CM-5835 | Braunstein Caliper, 3.5/4.0mm                      |
| 15. CM-5815 | Gass Retinal Detachment Hook           | 36. CM-5836 | Squeeze Handle Scissors, horizontal, curved, 23ga. |
| 16. CM-5816 | Schocket Scleral Depressor             | 37. CM-5837 | Squeeze Handle Forceps, serrated jaws, 23ga.       |
| 17. CM-5817 | Castroviejo Caliper, straight          | 38. CM-5838 | Squeeze Handle Forceps, end gripping, 23ga.        |
| 18. CM-5818 | Gass Scleral Marker                    | 39. CM-5839 | Squeeze Handle Forceps, asymmetrical, 23ga.        |
| 19. CM-5819 | Watzke Sleeve Spreading Forceps        | 40. CM-5840 | Squeeze Handle Forceps, ILM, 23ga.                 |
| 20. CM-5820 | Bonaccolto Conjunctiva Forceps         | 41. CM-5841 | Sterilizing Case, double, aluminum not shown       |
| 21. CM-5821 | Nugent Utility Forceps, serrated       |             |  |



**CM-5900 • ENUCLEATION SET**

- |  |   |
|--|---|
| 1. CM-5901 Lester-Burch Eye Speculum       | 6. CM-5906 Stevens Scissors, straight                     |
| 2. CM-5902 Bunge Evisceration Spoon, large | 7. CM-5907 Enucleation Scissors, strong curve             |
| 3. CM-5903 Bunge Evisceration Spoon, small | 8. CM-5908 Tissue Forceps                                 |
| 4. CM-5904 Wells Enucleation Spoon         | 9. CM-5909 Halsted Mosquito Forceps, curved               |
| 5. CM-5905 Graefe Muscle Hook #2           | 10. CM-5910 Sterilizing Case, large, plastic<br>not shown |

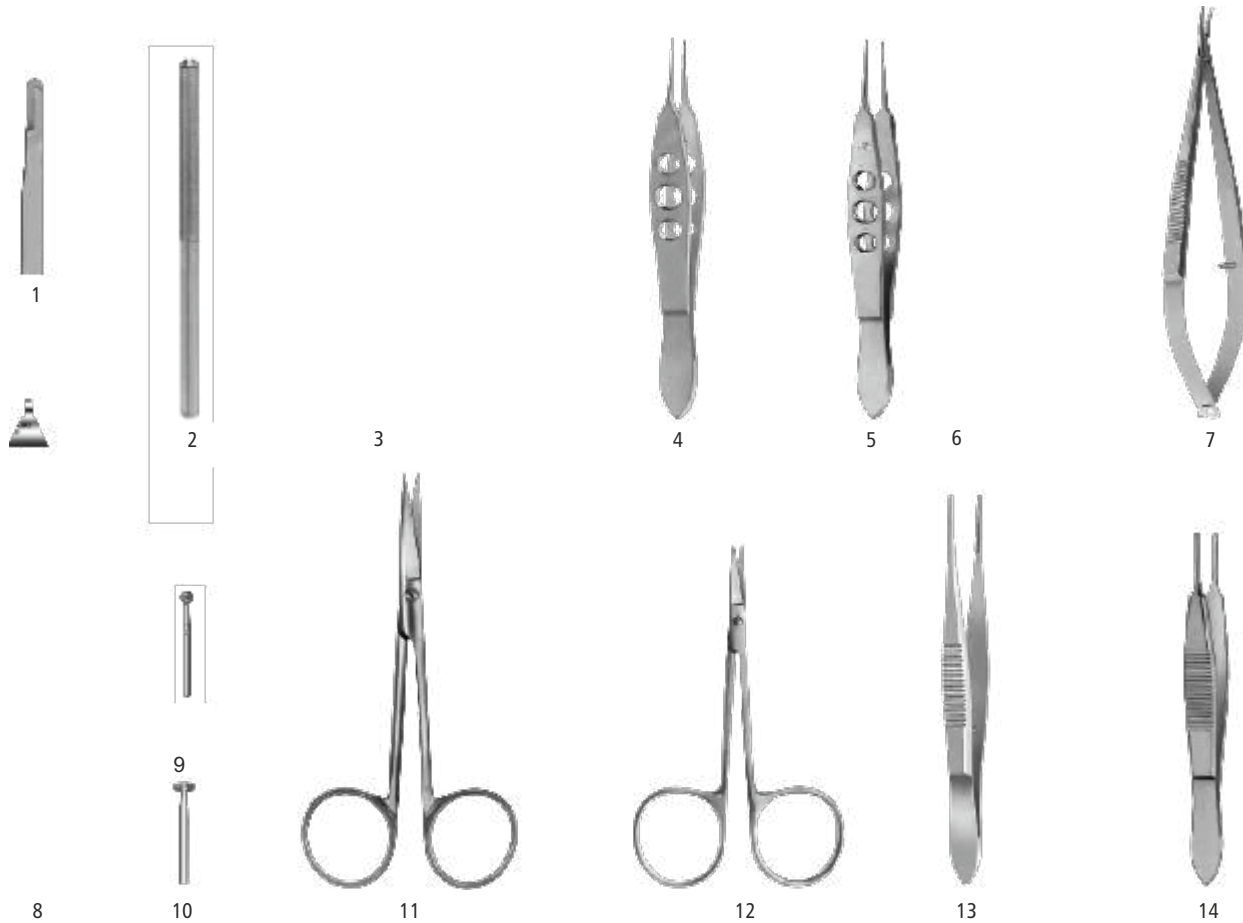

**CM-6000 • PTERYGIUM SET**

- |            |                                      |             |  |
|------------|--------------------------------------|-------------|--|
| 1. CM-6001 | Miniature Blade #64, disposable (bx) | 8. CM-6008  | Katena Ophthalmic Burr                       |
| 2. CM-6002 | Chuck Handle                         | 9. CM-6009  | Diamond Burr, 5.0mm diameter ball            |
| 3. CM-6003 | Lancaster Eye Speculum               | 10. CM-6010 | Diamond Burr, 5.0mm diameter disc            |
| 4. CM-6004 | McPherson Tying Forceps, straight    | 11. CM-6011 | Eye Scissors, straight, standard             |
| 5. CM-6005 | Castroviejo Forceps, 0.12mm          | 12. CM-6012 | Eye Scissors, straight, small                |
| 6. CM-6006 | Gill Corneal Knife                   | 13. CM-6013 | Bonaccolto Conjunctiva Forceps               |
| 7. CM-6007 | Castroviejo Needle Holder, curved    | 14. CM-6014 | Lester Fixation Forceps                      |
|            |                                      | 15. CM-6015 | Sterilization Case, large, plastic not shown |

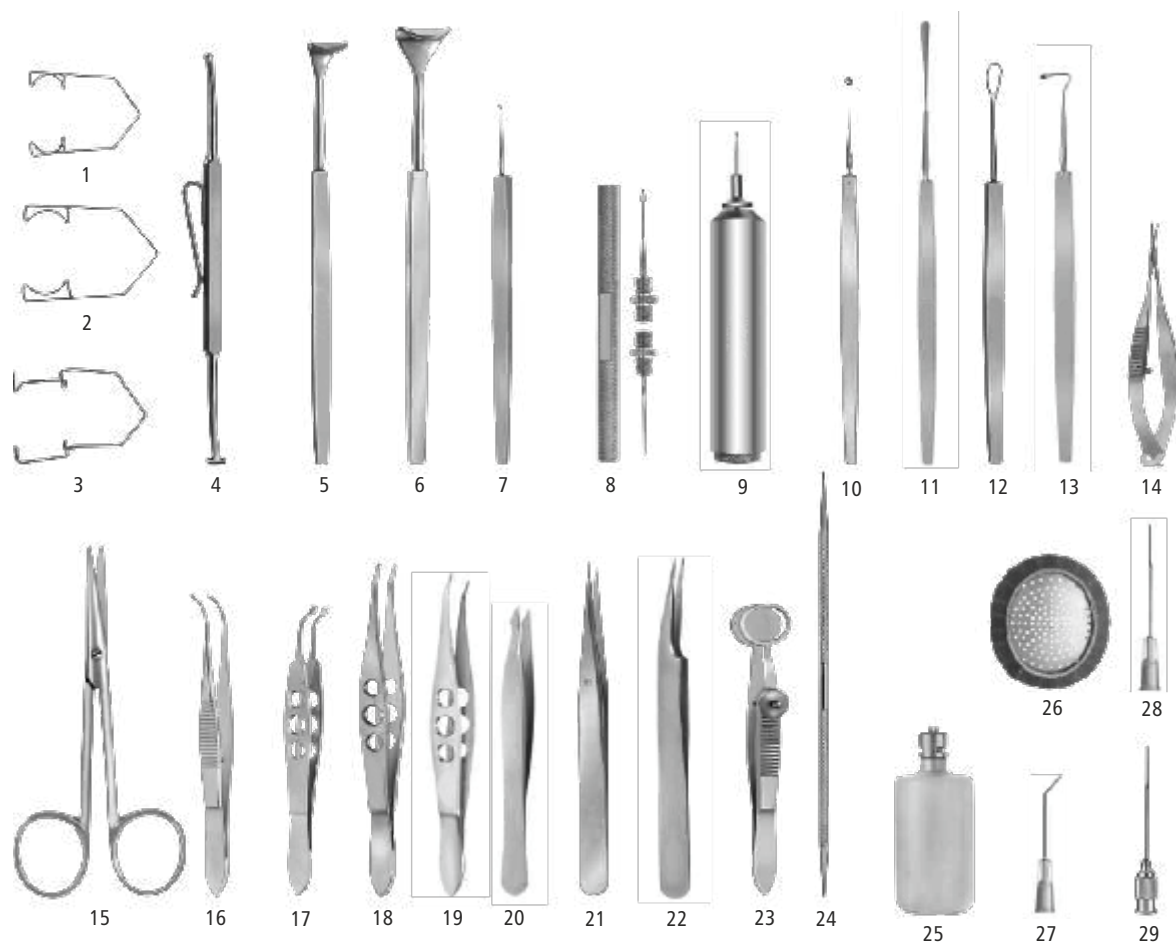

**CM-6100 • OFFICE SET**

- |  |  |
|--|--|
| 1. CM-6101 Bar raquer Wire Speculum, 10mm blades                   | 16. CM-6116 Dressing Forceps, curved                             |
| 2. CM-6102 Bar raquer Wire Speculum, 15mm blades                   | 17. CM-6117 Arita Meibomian Gland Compressor                     |
| 3. CM-6103 Kratz-Bar raquer Wire Speculum, 15mm blades             | 18. CM-6118 Bar raquer Cilia Forceps, lightly angled             |
| 4. CM-6104 Schocket Scleral Depressor                              | 19. CM-6119 Gold Punctal Plug Forceps                            |
| 5. CM-6105 Desmarres Lid Retractor, size 0, 11mm wide              | 20. CM-6120 Katena Cilia Forceps                                 |
| 6. CM-6106 Desmarres Lid Retractor, size 2, 15mm wide              | 21. CM-6121 Jewellers Forceps, delicate, straight                |
| 7. CM-6107 Golf Club Foreign Body Spud                             | 22. CM-6122 Suture Removal Forceps                               |
| 8. CM-6108 Spud & Gouge, in reversible handle                      | 23. CM-6123 Francis Chalazion Forceps, oval                      |
| 9. CM-6109 Algerbrush II, complete with "AA" battery and two burrs | 24. CM-6124 Castro Viejo Lacrimal Dilator, double-end            |
| 10. CM-6110 Meyerhoefer Chalazion Curette, size 3, 2.5mm dia.      | 25. CM-6125 Bishop-Harmon A/C Irrigator                          |
| 11. CM-6111 Kimura Platinum Spatula                                | 26. CM-6126 Fox Aluminum Eye Shield, adult                       |
| 12. CM-6112 New Orleans Lens Loop                                  | 27. CM-6127 Bishop-Harmon Cannula, 19ga., sterile, disp. (bx/10) |
| 13. CM-6113 Jameson Muscle Hook, small                             | 28. CM-6128 Lacrimal Cannula, 19ga., sterile, disp. (bx/10)      |
| 14. CM-6114 McPherson-Vannas Iris Scissors, curved                 | 29. CM-6129 Lacrimal Cannula, 23ga. straight                     |
| 15. CM-6115 Knapp Stabismus Scissors, straight                     | 30. CM-6130 Sterilizing Case, double, aluminum not shown         |

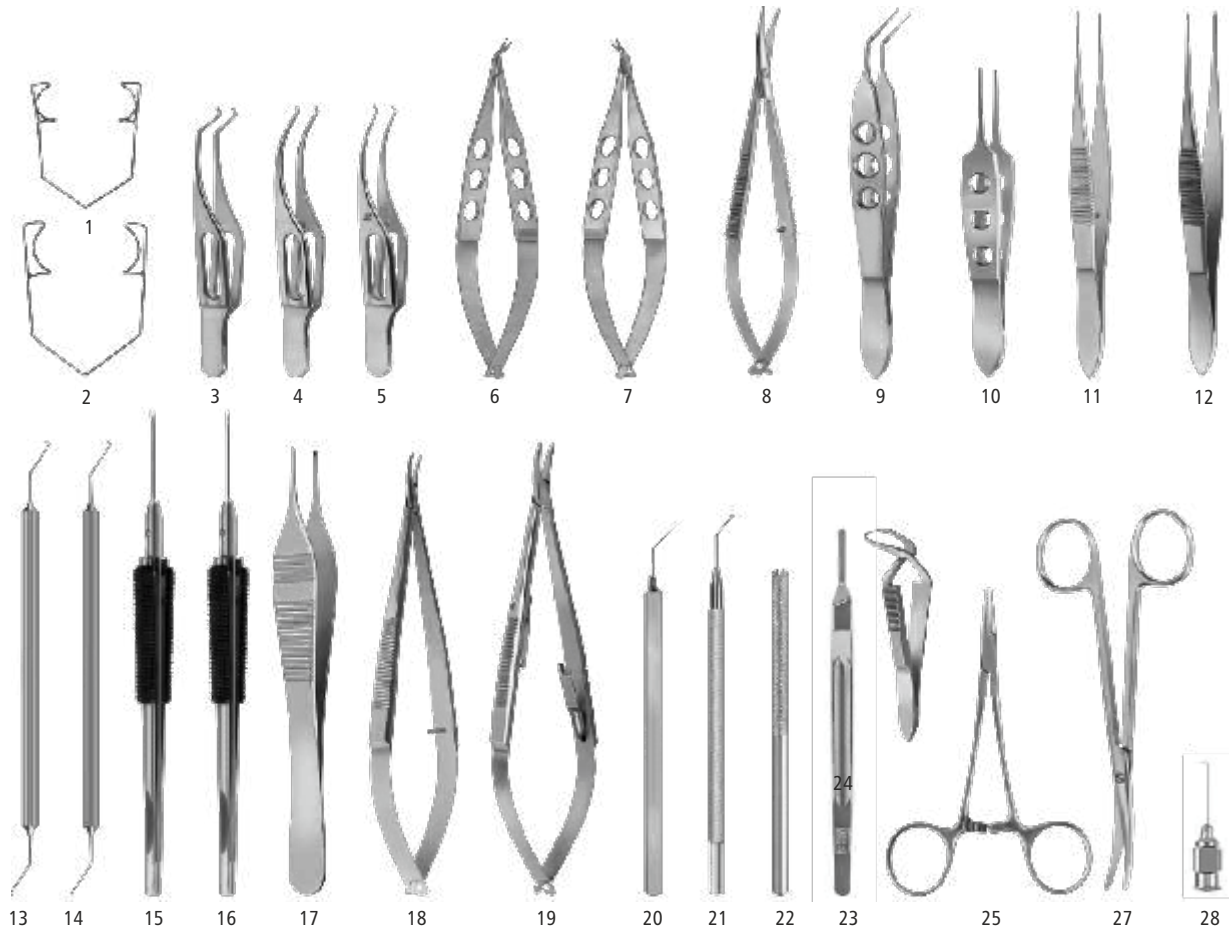

**CM-6200 • VETERINARY OPHTHALMIC SET**

- |   |  |
|---|--|
| 1. CM-6201 Barraquer Wire Speculum, small             | 16. CM-6216 Intraocular Scissors, angled 30°               |
| 2. CM-6202 Barraquer Wire Speculum, large             | 17. CM-6217 Adson Tissue Forceps                           |
| 3. CM-6203 Iris Forceps                               | 18. CM-6218 Castroviejo Needle Holder, curved, w/lock      |
| 4. CM-6204 Colibri Forceps, 1x2 teeth, 0.4mm          | 19. CM-6219 Castroviejo Needle Holder, heavy, curved       |
| 5. CM-6205 Harms-Colibri Forceps, 0.12mm              | 20. CM-6220 Sinskey Lens Hook, angled                      |
| 6. CM-6206 Castroviejo Corneal Scissors, small, right | 21. CM-6221 Jaffe-Bechert Rotator, 9mm                     |
| 7. CM-6207 Castroviejo Corneal Scissors, small, left  | 22. CM-6222 Chuck Handle (2)                               |
| 8. CM-6208 Westcott Tenotomy Scissors                 | 23. CM-6223 Bard-Parker Handle                             |
| 9. CM-6209 Utrata Capsulorrhexis Forceps              | 24. CM-6224 Jones Towel Clamp (4)                          |
| 10. CM-6210 Bishop-Harmon Forceps                     | 25. CM-6225 Halsted Mosquito Forceps, straight (2)         |
| 11. CM-6211 Dressing Forceps, delicate, straight      | 26. CM-6226 Halsted Mosquito Forceps, curved (2)           |
| 12. CM-6212 Tissue Forceps, delicate, straight        | 27. CM-6227 Metzenbaum Dissecting Scissors                 |
| 13. CM-6213 Chang Phaco Chopper                       | 28. CM-6228 Chang Hydrodissection Cannula                  |
| 14. CM-6214 Warren Canine Phaco Chopper               | 29. CM-6229 Instrument Case, double, aluminum<br>not shown |
| 15. CM-6215 Intraocular Scissors, straight            |  |



 Noal More, Roras Road,  
Sialkot 51310 - Pakistan.

 0092 323 4303862

 0092 323 4303862

 [info@caremedical.com.pk](mailto:info@caremedical.com.pk)

 [www.caremedical.com.pk](http://www.caremedical.com.pk)



cGMP



ISO:9001:2015  
ISO:13485:2016